



CMR-5975

Digicast Media Router S2 Receiver
CMR-5975 – MR-S2

Installation and Operation Manual

Part Number MN-CMR5975-IOM

Revision 3

October 7, 2008

Copyright © Comtech EF Data, 2008. All rights reserved. Printed in the USA.
Comtech EF Data, 2114 West 7th Street, Tempe, Arizona 85281 USA, (480) 333-2200, FAX: (480) 333-2161



Errata B

Comtech EF Data Documentation Update

Subject: Changes to DVB-S2 Pilot, Chapter 4 and Appendix D

Date: October 5, 2009

Original Manual Part Number: MNCMR5975.IOM **Rev 3**

Errata Number / Agile Document ID ER-CMR5975-EB3 **Agile CO Number** C09574

Change Specifics:

This information will be incorporated into the next revision:

Added to Chapter 4, 4.2.12 Tuner, p. 4-21:

Pilot

Enables or disables the Pilot for DVB-S2 mode of operation only.

Important: Pilots must be enabled for reliable operation below 6.0 Msps.

Added to Chapter 4, 4.3.9.1 Tuner Configuration Menu, p. 4-51:

Pilot

Enables or disables the Pilot for DVB-S2 mode of operation only.

Important: Pilots must be enabled for reliable operation below 6.0 Msps.

Added to Appendix D, D.2 Required Information for Setting up a Digicast Satellite Receiver, p. D-3:

8. Pilots

Important: Pilots must be enabled for reliable operation below 6.0 Msps.

Added to Appendix D, D.5 Required Important Terms to Understand, p. D-7:

Pilots

Important: Pilots must be enabled for reliable operation below 6.0 Msps.



Errata A

Comtech EF Data Documentation Update

Subject: Changes to Appendix F. DVB-S/S2 BER Performance

Date: June 26, 2009

Original Manual Part Number: MNCMR5975.IOM **Rev 3**

Errata Number / Agile Document ID ER-CMR5975-EA3 **Agile CO Number** C08557

Change Specifics:

This information will be incorporated into the next revision. Appendix F, p. F-1:

Test Configuration:

Symbol Rate: 20 Msps
Frame Size = 64,800 (Normal Frames)
Pilots: Off
Roll Off: 35%
Nominal Input Power: -48 dB
L-Band Frequency: 1,170 MHz

Input Range:

-25 to -61 dBm (2 Msps)
-25 to -60 dBm (6 Msps)
-25 to -59 dBm (10 Msps)
-25 to -57 dBm (20 Msps)
-25 to -56 dBm (32 Msps)

Receive signal level Monitor Accuracy ± 10 dB (-25 to -50 dBm)

Assumptions:

QEF = 10^{-7} PER
Es/No = C/N

Table of Contents

PREFACE	VII
Customer Support	vii
About this Manual	viii
Conventions and References	viii
EXAMPLES OF MULTI-HAZARD FORMATS	VIII
Electromagnetic Compatibility (EMC) Compliance	ix
Safety Compliance	x
Warranty Policy	xi
CHAPTER 1. INTRODUCTION	1-1
1.1 Introduction	1-1
1.2 Standard Features	1-2
1.3 Performance	1-3
1.4 Configurations	1-3
1.5 Specifications	1-4
1.6 Terminology	1-5
CHAPTER 2. INSTALLATION AND INITIAL CONFIGURATION	2-1
2.1 Major Assembly	2-1
2.2 Unpacking	2-1
2.3 Installation	2-2
2.4 Initial Configuration	2-3

CHAPTER 3. INTERFACE PINOUTS.....	3-1
3.1 Pinout Overview	3-1
3.2 DC Power	3-1
3.3 RJ-45 Ethernet.....	3-2
3.4 RJ-12 Redundancy	3-2
3.5 RJ-12 Terminal	3-2
3.6 F-Type L-Band	3-2
CHAPTER 4. DEVICE MANAGEMENT VIA USER INTERFACES.....	4-1
4.1 Introduction.....	4-1
4.2 Web Interface	4-1
4.2.1 Administrative Configuration	4-4
4.2.2 SNMP Configuration	4-6
4.2.3 Vload Configuration.....	4-7
4.2.4 Syslog Configuration.....	4-8
4.2.5 Redundancy Configuration.....	4-9
4.2.6 Network Configuration	4-10
4.2.7 Network ARP.....	4-12
4.2.8 IGMP Configuration	4-13
4.2.9 Unicast Routing Configuration.....	4-14
4.2.10 MPE/IP Configuration	4-15
4.2.11 Tuner MPEG TS Route Configuration.....	4-17
4.2.12 Tuner Configuration.....	4-19
4.2.13 Tuner Statistics	4-22
4.3 Terminal Interface.....	4-24
4.3.1 Login	4-26
4.3.2 Main Menu	4-27
4.3.3 Redundancy Menu.....	4-28
4.3.4 Administration Menu	4-29
4.3.5 IGMP Configuration Menu.....	4-34
4.3.6 Stats Menu.....	4-35
4.3.7 Network Configuration Menu.....	4-46
4.3.8 Unicast Routing Configuration Menu	4-47
4.3.9 Tuner Menu	4-48
4.4 Telnet Interface.....	4-54
4.5 Trivial File Transfer Protocol (TFTP)	4-55
4.6 Simple Network Management Protocol (SNMP)	4-57
4.6.1 SNMP Traps	4-58

APPENDIX A. SOFTWARE UPGRADE	A-1
A.1 Introduction	A-1
A.2 Web Interface.....	A-2
A.3 Telnet or Terminal Interface	A-4
APPENDIX B. IP ROUTING SUPPORT	B-1
B.1 Introduction	B-1
B.2 IP Configuration.....	B-1
B.2.1 Unicast Routing	B-2
B.2.2 Multicast Routing	B-2
B.3 Section Packing.....	B-3
APPENDIX C. SYSTEM LOG CONFIGURATION.....	C-1
C.1 Introduction	C-1
C.2 Enabling a System Logger.....	C-1
APPENDIX D. SETTING UP A DIGICAST DIGITAL SATELLITE RECEIVER.....	D-1
D.1 Introduction	D-1
D.2 Required Information for Setting Up a Digicast Satellite Receiver	D-3
D.3 Verify Frequency Values	D-4
D.4 Configure the Equipment	D-5
D.5 Important Terms to Understand	D-7
APPENDIX E. CONFIGURING AND CONTROLLING THE DIGICAST CMR-5975 MEDIA ROUTER WITH SNMP	E-1
E.1 Required SNMP Information for Configuring a Digicast Product	E-1
E.2 Configuring the Digicast CMR-5975 Product for SNMP	E-2
E.3 SNMP and Digicast Products.....	E-3
E.4 MIB II.....	E-4
E.4.1 MIB II OIDs on the Digicast Media Router (Model CMR-5975)	E-5
E.5 Private MIB.....	E-10

E.5.1 Private MIB OIDs on Digicast Products..... E-11

E.6 Important Terms to Know E-12

APPENDIX F. DVB-S/S2 BER PERFORMANCE AT QUASI-ERROR FREE (QEF) F-1

Tables

Table 1-1. Digicast Media Router S2 Receiver – Specifications..... 1-4

Table 1-2. Referenced Acronyms 1-5

Table 2-1. Digicast Media Router S2 Receiver – Standalone Configuration 2-1

Figures

Figure 1-1. Digicast Media Router S2 Receiver – Front Panel	1-1
Figure 1-2. Digicast Media Router S2 Receiver – Rear Panel	1-2
Figure 1-3. Digicast Media Router S2 Receiver	1-3
Figure 3-1. Digicast Media Router S2 Receiver – Rear Panel	3-1
Figure 4-1. Connecting to the MR-S2.....	4-2
Figure 4-2. MR-S2 Login page.....	4-2
Figure 4-3. MR-S2 Home page.....	4-3
Figure 4-4. MR-S2 Administrative Configuration page.....	4-4
Figure 4-5. SNMP Configuration page.....	4-6
Figure 4-6. Vload Configuration Page.....	4-7
Figure 4-7. Syslog Configuration page.....	4-8
Figure 4-8. Redundancy Configuration page.....	4-9
Figure 4-9. Network Configuration page.....	4-10
Figure 4-10. Network ARP Configuration page.....	4-12
Figure 4-11. IGMP Configuration page.....	4-13
Figure 4-12. Unicast Routing Configuration page.....	4-14
Figure 4-13. MPE/IP Configuration page.....	4-15
Figure 4-14. Tuner MPEG TS Route Configuration (full) page.....	4-17
Figure 4-15. Tuner Available Configuration page (headers and dialogue box)	4-17
Figure 4-16. Tuner Configuration page	4-19
Figure 4-17. Tuner Statistics page	4-22
Figure 4-18. Menu Hierarchy (via Terminal Interface)	4-25
Figure 4-19. Login Prompt	4-26
Figure 4-20. Main Menu	4-27
Figure 4-21. Main Menu	4-28
Figure 4-22. Admin Menu	4-29
Figure 4-23. Vload Menu.....	4-31
Figure 4-24. Main Menu	4-32
Figure 4-25. Main Menu	4-33
Figure 4-26. IGMP Configuration Menu	4-34
Figure 4-27. MR-S2 Stats Menu	4-35
Figure 4-28. Stats Menu Hierarchy (via Terminal Interface)	4-36
Figure 4-29. DMA Stats Menu	4-37
Figure 4-30. Ethernet Stats Menu	4-38
Figure 4-31. Tuner Stats Menu	4-39
Figure 4-32. Tuner MPE/IP Stats Menu	4-40
Figure 4-33. Detailed Tuner MPE/IP Stats Menu.....	4-41
Figure 4-34. Detailed Tuner MPE/IP Advanced Stats Menu	4-42
Figure 4-35. Tuner MPEG TS Stats Menu	4-43

Figure 4-36. Detailed Tuner MPEG TS Stats	4-44
Figure 4-37. Detailed Tuner MPEG TS Advanced Stats Menu.....	4-44
Figure 4-38. Detailed Tuner Stats Menu.....	4-45
Figure 4-39. Network Configuration Menu.....	4-46
Figure 4-40. Unicast Routing Configuration Menu.....	4-47
Figure 4-41. Tuner Menu.....	4-48
Figure 4-42. Tuner Configuration Menu	4-49
Figure 4-43. Tuner MPE/IP Configuration Menu.....	4-52
Figure 4-44. Tuner MPEG TS Configuration Menu.....	4-53
Figure 4-45. Starting Telnet Session.....	4-54
Figure 4-46. Main Menu via Telnet.....	4-55
Figure A-1. TFTP Download (via Web).....	A-3
Figure A-2. TFTP Download (via Terminal).....	A-4
Figure A-3. TFTP Download Complete (via Terminal)	A-5
Figure B-1. Multicast Mapping (IP to MAC)	B-3
Figure B-2. Section Packing	B-3

Preface

Customer Support

Contact the Comtech EF Data Customer Support Department for:

- Product support or training
- Reporting comments or suggestions concerning manuals
- Information on upgrading or returning a product

A Customer Support representative may be reached at:

Comtech EF Data
Attention: Customer Support Department
2114 West 7th Street
Tempe, Arizona 85281 USA

480.333.2433 or 480.333.4357 (Customer Support Desk)
480.282.2850 (After Hours Support)
480.333.2161 FAX

To return a Comtech EF Data product (in-warranty and out-of-warranty) for repair or replacement:

- **Contact** the Comtech EF Data Customer Support Department. Be prepared to supply the Customer Support representative with the model number, serial number, and a description of the problem.
- **Request** a Return Material Authorization (RMA) number from the Comtech EF Data Customer Support representative.
- **Pack** the product in its original shipping carton/packaging to ensure that the product is not damaged during shipping.
- **Ship** the product back to Comtech EF Data. (Shipping charges should be prepaid.)

For Online Customer Support:

An RMA number request can be requested electronically by contacting the Customer Support Department through the online support page at www.comtechefdata.com/service.asp:

- **Click** on the “RMA Request Form” hyperlink, then fill out the form completely before sending.
- **Send e-mail** to the Customer Support Department at cdmipsupport@comtechefdata.com.

For information regarding this product’s warranty policy, refer to the Warranty Policy, p. xi.

About this Manual

This manual provides installation and operation information, functional capabilities, and performance specifications for the Comtech EF Data (CEFD) CMR-5975 Digicast Media Router S2 Receivers – referred to collectively throughout this manual as “the MR-S2”. The manual additionally provides information on how to connect the MR-S2 to other data transport equipment.

This is a technical document intended for earth station engineers, technicians, and operators responsible for the operation and maintenance of the CEFD Digicast CMR-5975 Media Router S2 Receivers.

Reporting Comments or Suggestions Concerning this Manual

Comments and suggestions regarding the content and design of this manual are appreciated. To submit comments, please e-mail the Comtech EF Data Technical Publications Department at techpub@comtechefdata.com.

Conventions and References

Cautions and Warnings



IMPORTANT

IMPORTANT or **NOTE** indicates a statement that is associated with the task being performed or information critical for proper equipment function.



CAUTION

CAUTION indicates a hazardous situation that, if not avoided, may result in minor or moderate injury. **CAUTION** may also be used to indicate other unsafe practices or risks of property damage.



WARNING

WARNING indicates a potentially hazardous situation that, if not avoided, could result in death or serious injury.

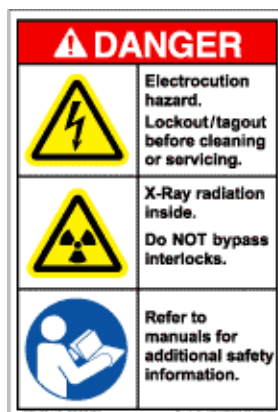

Examples of
Multi-Hazard Formats

Metric Conversion

Metric conversion information is located on the inside back cover of this manual. This information is provided to assist the operator in cross-referencing non-Metric to Metric conversions.

Recommended Standard Designations

Recommended Standard (RS) Designations are interchangeable with the designation of the Electronic Industries Association (EIA).

Trademarks

Windows is a trademark of the Microsoft Corporation.

Other product names mentioned in this manual may be trademarks or registered trademarks of their respective companies and are hereby acknowledged. Comtech EF Data neither endorses nor otherwise sponsors any such production or services referred herein.

Electromagnetic Compatibility (EMC) Compliance

This is a Class B product. In a domestic environment, it may cause radio interference that requires the user to take adequate protection measures.

Emissions Compliance

This equipment has been tested and found to comply with the limits for a Class A digital device, pursuant to Part 15 of the Federal Communications Commission (FCC) rules, and EN55022 Class A requirements.

These limits are designed to provide reasonable protection against harmful interference when the equipment is operated in a commercial environment.

EN61000 Compliance

This equipment meets the EMC/immunity characteristics for the limits and methods of measurement for information technology equipment as per EN61000-4-2, EN61000-4-3, EN61000-4-4, EN61000-4-5 and EN61000-4-11.

This equipment meets the EMC/immunity characteristics for the limits and methods of measurement of mains harmonics & flicker for information technology equipment as per CE EN61000-3-2 and EN61000-3-3.

Safety Compliance

EN60950 Compliance

Applicable testing is routinely performed as a condition of manufacturing on all units to ensure compliance with safety requirements of EN60950. This equipment meets the Safety of Information Technology Equipment specification as defined in EN60950.



Low Voltage Directive (LVD)

The following information is applicable for the European Low Voltage Directive (EN60950):

<HAR>	Type of power cord required for use in the European Community.
	CAUTION: Double-pole/Neutral Fusing ACHTUNG: Zweipolige bzw. Neutralleiter-Sicherung

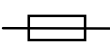
International Symbols:

Symbol	Definition
	Alternating Current
	Fuse

Symbol	Definition
	Protective Earth / Safety Ground
	Chassis Ground



For additional symbols, refer to Cautions and Warnings listed earlier in this Preface.

Warranty Policy

Comtech EF Data products are warranted against defects in material and workmanship for a period of two years from the date of shipment. During the warranty period, Comtech EF Data will, at its option, repair or replace products that prove to be defective.

For equipment under warranty, the owner is responsible for freight to Comtech EF Data and all related customs, taxes, tariffs, insurance, etc. Comtech EF Data is responsible for the freight charges only for return of the equipment from the factory to the owner. Comtech EF Data will return the equipment by the same method (i.e., Air, Express, Surface) as the equipment was sent to Comtech EF Data.

All equipment returned for warranty repair must have a valid RMA number issued prior to return and be marked clearly on the return packaging. Comtech EF Data strongly recommends all equipment be returned in its original packaging.

Comtech EF Data Corporation's obligations under this warranty are limited to repair or replacement of failed parts, and the return shipment to the buyer of the repaired or replaced parts.

Limitations of Warranty

The warranty does not apply to any part of a product that has been installed, altered, repaired, or misused in any way that, in the opinion of Comtech EF Data Corporation, would affect the reliability or detracts from the performance of any part of the product, or is damaged as the result of use in a way or with equipment that had not been previously approved by Comtech EF Data Corporation.

The warranty does not apply to any product or parts thereof where the serial number or the serial number of any of its parts has been altered, defaced, or removed.

The warranty does not cover damage or loss incurred in transportation of the product.

The warranty does not cover replacement or repair necessitated by loss or damage from any cause beyond the control of Comtech EF Data Corporation, such as lightning or other natural and weather related events or wartime environments.

The warranty does not cover any labor involved in the removal and or reinstallation of warranted equipment or parts on site, or any labor required to diagnose the necessity for repair or replacement.

The warranty excludes any responsibility by Comtech EF Data Corporation for incidental or consequential damages arising from the use of the equipment or products, or for any inability to use them either separate from or in combination with any other equipment or products.

A fixed charge established for each product will be imposed for all equipment returned for warranty repair where Comtech EF Data Corporation cannot identify the cause of the reported failure.

Exclusive Remedies

Comtech EF Data Corporation's warranty, as stated is in lieu of all other warranties, expressed, implied, or statutory, including those of merchantability and fitness for a particular purpose. The buyer shall pass on to any purchaser, lessee, or other user of Comtech EF Data Corporation's products, the aforementioned warranty, and shall indemnify and hold harmless Comtech EF Data Corporation from any claims or liability of such purchaser, lessee, or user based upon allegations that the buyer, its agents, or employees have made additional warranties or representations as to product preference or use.

The remedies provided herein are the buyer's sole and exclusive remedies. Comtech EF Data shall not be liable for any direct, indirect, special, incidental, or consequential damages, whether based on contract, tort, or any other legal theory.

Chapter 1. INTRODUCTION



Figure 1-1. Digicast Media Router S2 Receiver – Front Panel

1.1 Introduction

The Comtech EF Data (CEFD) Digicast Media Router S2 Receivers – referred to collectively throughout this manual as “the MR-S2” – comes in one configuration:

- **CEFD Digicast Media Router S2 Receiver – CMR-5975 (MR-S2) L-Band to IP Receiver**

The MR-S2 is an economical L-Band-to-IP Receiver providing price-versus-performance unparalleled in today’s market.

The MR-S2 receives Multiprotocol Encapsulated (MPE) data as specified in ETSI EN 301 192 over MPEG-2 packets or raw Transports Streams (TS) carrying audio, video or data over an L-Band input.

The MR-S2 supports:

- DVB-S (2 to 45 Msps)
 - FEC Rates: 1/2, 2/3, 3/4, 5/6 and 7/8
- DVB-S2 QPSK (2 to 32 Msps)
 - FEC Rates: 1/2, 3/5, 2/3, 3/4, 4/5, 5/6, 8/9 and 9/10
- DVB-S2 8PSK (2 to 32 Msps)
 - FEC Rates: 3/5, 2/3, 3/4, 5/6, 8/9 and 9/10

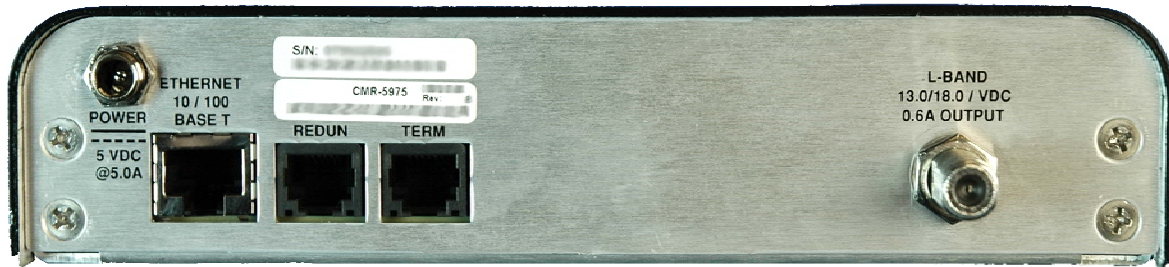

Figure 1-2. Digicast Media Router S2 Receiver – Rear Panel

1.2 Standard Features

Based on an embedded architecture, utilizing a FreeScale MPC859 CPU and eCOS Operating System, the MR-S2 provides the following features:

- High Reliability
- DVB-S and DVB-S2 L-Band Input
- Ethernet Output rates as high as 83 Mbps (1,500 byte packets)
- Support for Multicast and Unicast IP datagrams
- Supports the decapsulation of MPE
- MPE Section Packing and Non-Section Packing on a PID-by-PID basis
- Supports encapsulation of transport streams over IP
- Support for all valid PIDs in 8192 range
- 64 PIDs
- MPEG-2 188/204-byte operation
- Support for 802.1Q VLAN Tags
- IGMP for Multicast Route Announcements
- Redundancy
- Configurable Telnet and HTTP ports for security
- Color LEDs for status monitoring and rapid fault isolation
- Management (monitor, control and configuration):
 - Web Interface
 - TFTP for field software/firmware upgrade
 - Terminal Interface
 - Telnet
 - SNMP V2 (Private and MIB II) Support
 - Vload

1.3 Performance

The MR-S2 provides the following performance characteristics:

Item	Value
Maximum Bits Per Second (Maximum Packet Size 1,518 Bytes)	83 Mbps
Latency	Less than 10 ms
Minimum Symbol Rate	DVB-S (2 Msps) DVB-S2 (2 Msps)
Maximum Symbol Rate	DVB-S (45 Msps) DVB-S2 (32 Msps)
Minimum Input Level	-50 dBm
Minimum Input Level	-25 dBm

1.4 Configurations

The MR-S2, shown in Figure 1-2, is a Satellite-to-Ethernet IP router.

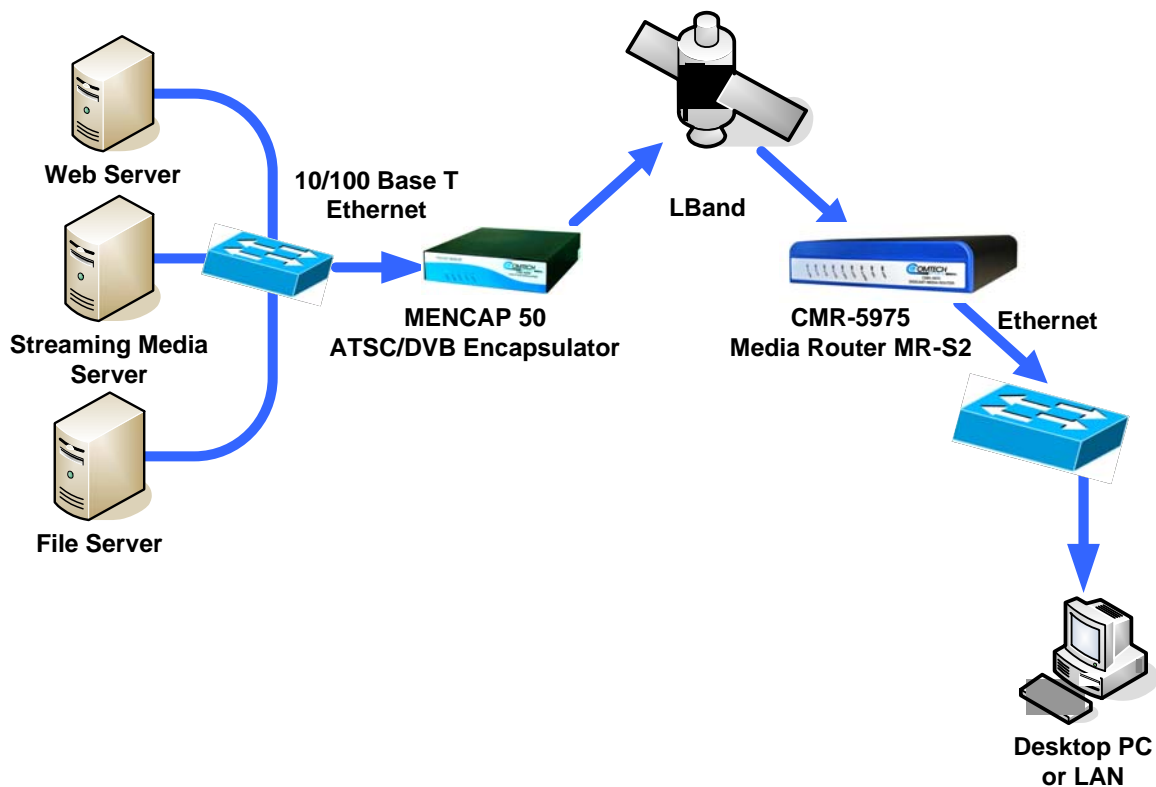

Figure 1-3. Digicast Media Router S2 Receiver

1.5 Specifications

Table 1-1. Digicast Media Router S2 Receiver – Specifications

Parameter		Specification		
L-Band Tuner	DVB-S	(2 to 45 Msps) FEC Rates: 1/2, 2/3, 3/4, 5/6 and 7/8		
	DVB-S2	QPSK	(2 to 32 Msps) FEC Rates: 1/2, 3/5, 2/3, 3/4, 4/5, 5/6, 8/9 and 9/10	
		8PSK	(2 to 32 Msps) FEC Rates: 3/5, 2/3, 3/4, 5/6, 8/9 and 9/10	
Physical	Dimensions	8.75" L x 7.125" W x 1.625" H (22.225 L x 18.0975 W x 4.1.275 H cm)		
	Weight	1.6 lbs. (0.6 kg)		
	Power	2.5 mm with screw type connector		
	L-Band Input	F-Type (75Ω)		
	Ethernet (10/100BaseT)	RJ-45		
	Terminal	RJ-12		
	Redundancy	RJ-12		
	LEDs	Blue	PWR	Power indicator
		Green	RED	Redundancy indicator
		Red	ALARM	Flashing when the unit is in an alarm state
		Green	LOCK	Steady light indicates that the receiver has obtained a locked signal
		Green	E-SPD	Ethernet speed
		Amber	E-COL	Ethernet collision indicator
Green		E-RX	Ethernet receive indicator	
Green		E-TX	Ethernet transmit indicator	
Electrical	Power Input / Consumption	100 to 240 VAC 47/63 Hz converted to +5VDC @ 5.0A/ <25W		
	L-Band Input	DVB-S ETSI EN 300 421 DVB-S2 ETSI EN 302 307		
	Ethernet (10/100BaseT)	IEEE 802.3u		
	Console	RS-232		
	Redundancy	RS-232		
Environmental	Temperature			
	Operating	32° to 104° Fahrenheit (0° to 40° Celsius)		
	Storage (Non-operating)	-22° to 150° Fahrenheit (-30° to 65° Celsius)		
	Humidity			
	Operating	10% to 75% Non-condensing		
	Storage (Non-operating)	Relative humidity to 95% with temperature ≤ 95° Fahrenheit (35° Celsius)		
	Altitude			
	Operating	Up to 10,000 feet (3048 m) above sea level		
Storage (Non-operating)	Survival up to 50,000 feet (15240 m) above sea level for up to 15 hours			

1.6 Terminology

The following table defines the acronyms referred to throughout this manual:

Table 1-2. Referenced Acronyms

Acronym	Definition
ASI	Asynchronous Serial Interface
ARP	Address Resolution Protocol
CEFD	Comtech EF Data
DVB	Digital Video Broadcasting
DVB-S	Digital Video Broadcasting - Satellite
DVB-S2	Digital Video Broadcasting - Satellite (Second Generation)
EBU	European Broadcasting Union
ETS	European Telecommunications Standard
FTP	File Transfer Protocol
HTML	Hypertext Markup Language
HTTP	HyperText Transport Protocol
IANA	Internet Assigned Number Authority
IGMP	Internet Gateway Messaging Protocol
IP	Internet Protocol
IRD	Integrated Receiver Decoder
LAN	Local Area Network
MAC	Media Access Control
Mbps	Mega bits per second
MIB	Management Information Base
MPE	Multi-Protocol Encapsulation
MPEG	Moving Pictures Expert Group
MPEGTS	Moving Pictures Expert Group Transport System
MR	Media Router
Msp	Megasymbol per second. A symbol is equivalent to 1 Hz of occupied bandwidth on a satellite (i.e., 34 Msp would be a satellite carrier occupying 34 MHz of bandwidth).
MUX	Multiplexer
PAT	Program Association Table The PAT lists PIDs for all PMTs in the stream.
PID	Packet Identifier
PMT	Program Map Table Program Map Tables contain information about programs. The PMTs describe which PIDs contain data relevant to the program. PMTs also provide metadata about the streams in their constituent PIDs.

Acronym	Definition
PSI	Program Specific Information Program Specific Information is comprised of four tables: Program Association (PAT), Program Map (PMT), Conditional Access (CAT), and Network Information (NIT).
RS	Reed Solomon
SNMP	Simple Network Management Protocol
SYSLOG	System Log
TCP	Transmission Control Protocol
TERM	Terminal
TFTP	Trivial File Transfer Protocol
TSD	Transport Stream Demultiplexer
UDP	User Datagram Protocol
VLAN	Virtual Local Area Network

Chapter 2. INSTALLATION AND INITIAL CONFIGURATION

2.1 Major Assembly

The CEFD MR-S2 is available in a standalone configuration. Table 2-1 lists the components provided with a standard configuration. In the event any listed item is missing, please contact Comtech EF Data Customer Support.

Table 2-1. Digicast Media Router S2 Receiver – Standalone Configuration

Quantity	Description
1	CMR-5975 [MR-S2]
1	SPU30-102 Power Supply
1	IEC Power Cable
1	CA-TERMINAL Terminal Cable
1	Quick Start sheet

2.2 Unpacking

The shipping container and packing materials should be retained for possible reshipment.

Perform a receiving inspection as follows:

- **Inspect** the shipping container for damage. If there is damage to the shipping container, **notify the carrier**.
 - **Check** to determine that all parts, materials and documentation have been shipped with the router.
 - **Inspect** the router for possible physical damage.
 - **Test** the router for proper operation.
-

- **Contact** Comtech EF Data Customer Support if the shipment is:
 - Incomplete
 - Physically damaged
 - Inoperable

2.3 Installation

The MR-S2 is designed for ease of installation and configuration. Once the unit has been removed from the packing container, please follow these instructions:

Step	Procedure
1	Place the MR-S2 on a flat surface with free-air flow where the LEDs can be clearly observed with unrestricted access to the rear panel of the unit.
2	It is suggested that the coaxial connection to the Low Noise Block (LNB) NOT be connected to the unit until the unit has been fully configured. If the unit will not be powering the LNB, it is recommend that an F-Type DC Block be installed on the input to the MR-S2's L-Band input
3	Connect the DC power connection to the connection labeled PWR on the back of the unit and tighten the restraining nut to ensure secure operation.
4	Connect an RJ-45 Ethernet cable (patch cord) to the port labeled ETHERNET . This cable should be connected to an Ethernet concentrator (hub) or switch.
5	Connect a terminal cable (supplied) to the port labeled TERM . This cable should be connected to a PC's serial port (DB-9) to initially configure the MR-S2.
6	Connect the AC power cord between a standard wall outlet and the power supply. The Blue LED will illuminate.
7	Upon startup, the following LEDs will illuminate on the MS-R2 front panel:

LED	Function Label	Description
Blue	PWR	LED illuminates if power is properly applied
Green	RED	Redundancy indicator
Red	ALARM	LED may illuminate since the unit is not yet configured
Green	LOCK	LED illuminates if the tuner is locked
Green	E-SPD	Ethernet speed
Green	E-COL	Ethernet collision indicator
Green	E-RX	LED flashes if there is Ethernet traffic/activity
Green	E-TX	
Green	E-LINK	LED illuminates if the Ethernet connection to the Hub/Switch is operational

2.4 Initial Configuration

The initial configuration involves setting up the IP parameters via the terminal cable. Once the IP parameters have been configured, the terminal cable can be removed. The terminal cable should be stored in a known location, since it may be needed in the future.

To configure the IP parameters:

Step	Procedure
1	Using a terminal emulator on a PC such as HyperTerminal™ or TeraTerm™, set up the communication port as follows: <ul style="list-style-type: none">• 38,400 BAUD• 8 Data Bits• 1 Stop Bit• No Parity• No Flow Control
2	Press the <ENTER> key on the PC – the login prompt should be displayed.
3	The default user is “ <i>comtech</i> ” and the default password is “ <i>comtech</i> ”. After logging in, the MR-S2’s menu should be displayed.
4	Press “ N ” for Network Menu.
5	Press “ I ” for the IP Address, Enter the IP Address and press <ENTER> .
6	Press “ M ” for the Subnet Mask. Enter the Subnet Mask and press <ENTER> .
7	Press “ G ” for the Default Gateway IP Address. Enter the Default Gateway Address and press <ENTER> .
8	Press “ S ” to save the parameters.
9	Press “ Y ” to confirm the saving of parameters.
10	Press “ X ” to exit to the main menu.

At this point, the unit has been configured for full operation and the terminal cable may be removed. The coaxial connection to the Low Noise Block (LNB) may now be safely attached to the L-Band input port. For continued operation the unit may be managed via the Terminal Interface; however, it is recommended to use the Web Interface for ease of management.

Notes:

Chapter 3. INTERFACE PINOUTS

3.1 Pinout Overview

The rear panel interface (Figure 3-1) provides all necessary external connections between the MR-S2 and other equipment.



Figure 3-1. Digicast Media Router S2 Receiver – Rear Panel

3.2 DC Power



Pin	Definition
Center	+5VDC
Outer Ring	GND

3.3 RJ-45 Ethernet



Pin	Definition
1	TXD+
2	TXD-
3	RXD+
4	N/C
5	N/C
6	RXD-
7	N/C
8	N/C

3.4 RJ-12 Redundancy

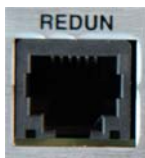

Pin	Definition
1	GND
2	TXD
3	RXD
4	GND
5	N/C
6	N/C

3.5 RJ-12 Terminal



Pin	Definition
1	GND
2	TXD
3	RXD
4	GND
5	N/C
6	N/C

3.6 F-Type L-Band



Pin	Definition
Center	Input 950-2150 MHz Output +13VDC or + 18VDC 0.6A
Outer Ring	GND

Chapter 4. DEVICE MANAGEMENT VIA USER INTERFACES

4.1 Introduction

Management of the MR-S2 is simple and intuitive. There are a variety of ways to configure and manage the MR-S2:

- Web Interface via a LAN-based Desktop Browser
- Terminal Interface via direct connection to a PC's asynchronous serial port
- Telnet Interface via a LAN
- TFTP for remote terminal upgrades
- SNMP Private MIB and MIB II
- Vload (software application allowing configuration changes to remote receivers)

4.2 Web Interface

The Web Interface, operating under standard HyperText Transport Protocol (HTTP), is used to communicate with and command the MR-S2 via a HyperText Markup Language-based Graphical User Interface (GUI). To utilize the Web Interface, a LAN connection must exist between the PC with a browser and the MR-S2.

The CMR-5975 requires that the user to be authenticated via login before the configuration can be viewed or modified. After a period of inactivity, the user will automatically be logged out, and must log in again to resume.

Once a valid IP Address, Subnet Mask and Default Gateway have been entered into the MR-S2, activate a browser on the desktop. Enter the IP address for the MR-S2 into the URL field as shown in Figure 4-1. If the port number has been modified from the **standard 80** via the Terminal Interface, then the port number must be appended with a colon to the IP address.



Figure 4-1. Connecting to the MR-S2

A successful connection between the PC and the MR-S2 will result in the display of the Login page shown in Figure 4-2.

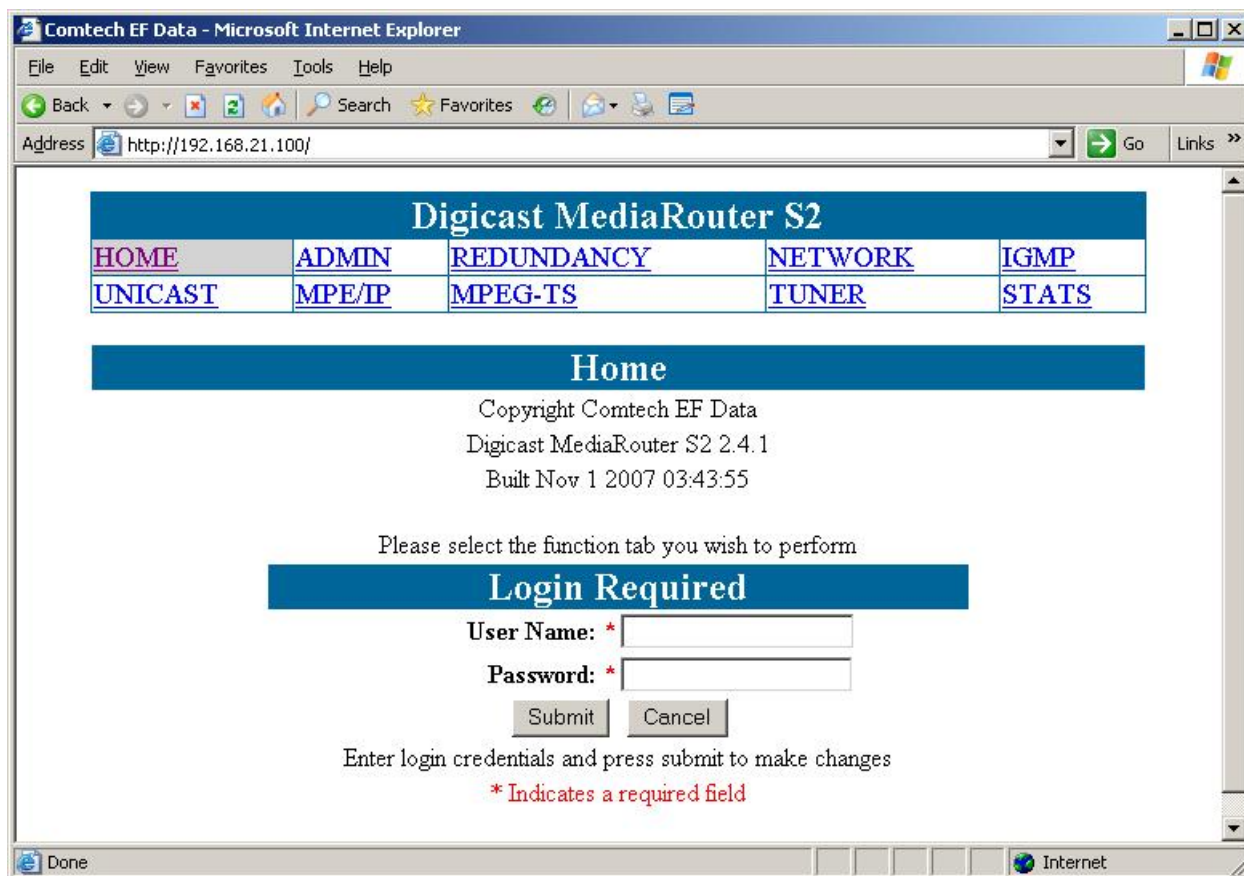

Figure 4-2. MR-S2 Login page

The Login page is the entry point to the MR-S2 menu system via a browser. The default user name is “comtech” and the default password is “comtech”.

The Home page (Figure 4-3) displays after successful login authentication:

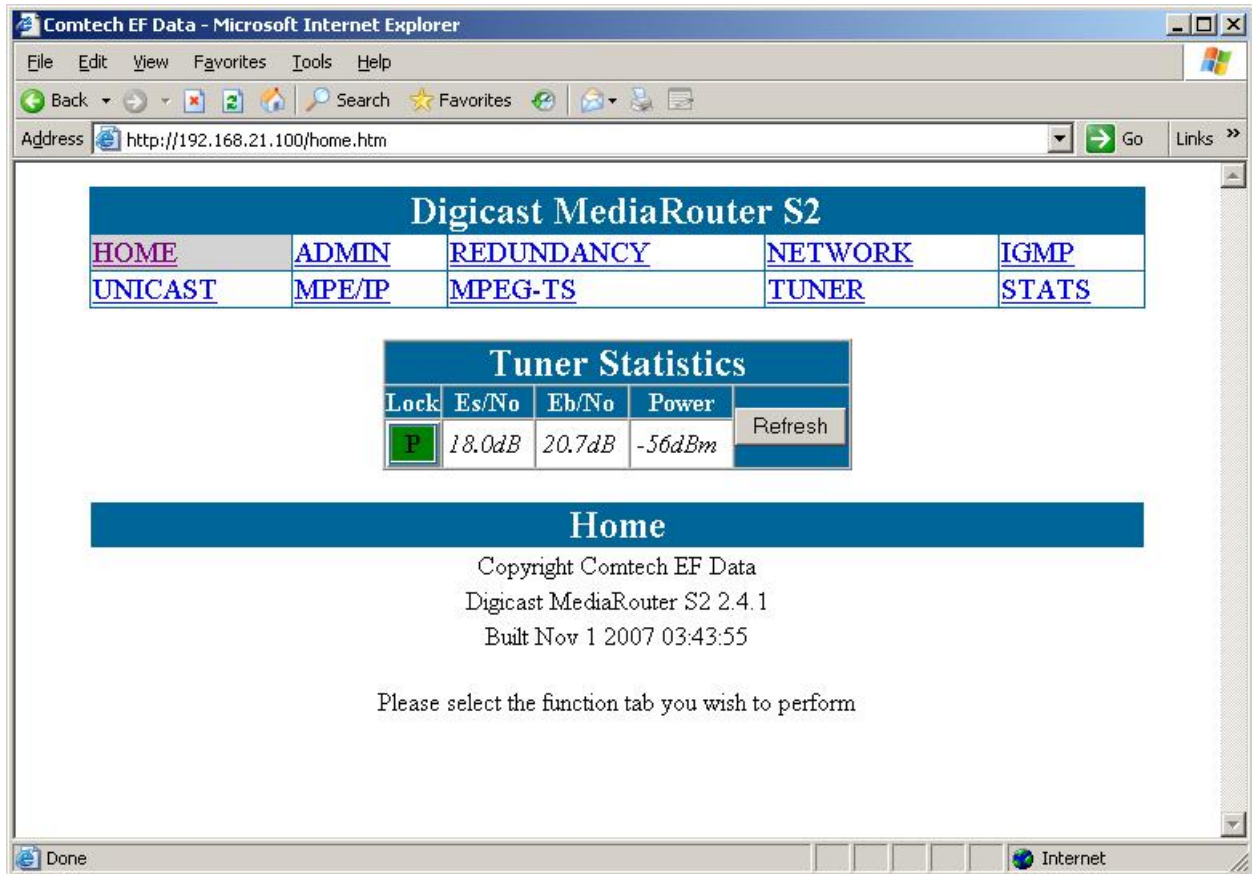

Figure 4-3. MR-S2 Home page

4.2.1 Administrative Configuration

The screenshot shows a web browser window titled "Comtech EF Data - Microsoft Internet Explorer" with the address bar showing "http://192.168.21.100/admin.htm". The main content area features a navigation menu with links: HOME, ADMIN, REDUNDANCY, NETWORK, IGMP, UNICAST, MPE/IP, MPEG-TS, TUNER, and STATS. Below this is a "Tuner Statistics" table:

Lock	Es/No	Eb/No	Power	
P	18.0dB	20.7dB	-56dBm	Refresh

The "Administrative Configuration" section includes links for [SNMP], [VLOAD], and [SYSLOG]. The configuration fields are as follows:

- Unit Name: * CMR-5975
- OS Version: eCOS 2.0
- App Version: 2.4.1
- FPGA Version: 4.0.0.12
- User Name: * comtech
- Password: *
- Confirm Password: *
- System Contact: * cmr3
- System Location: * comtech
- Enable Telnet: *

Buttons: Submit, Cancel, Reset Unit. Instruction: "Press submit to make changes". Note: "* Indicates a required field".

The "Update Firmware" section includes:

- Unit TFTP Server IP Address: *
- Image Type: * Application

Instruction: "Enter server IP and select type, then press submit to make changes". Note: "* Indicates a required field". Button: Update.

Figure 4-4. MR-S2 Administrative Configuration page

The MR-S2 Administrative Configuration page contains the following **configurable, required** parameters:

User Name

The MR-S2's User Name is user configurable and is used for connecting to the unit via IP management services and terminal services.

The default user name is "*comtech*".

Password

The Password is used for authenticating a user when connecting via IP management services.

The default password is "*comtech*".

The password is case sensitive and must be entered carefully.

When the password is changed, enter the password **twice** for verification.

System Contact

Enter the contact information of the system administrator for support.

System Location

Enter the physical location where the unit has been installed.

Enable Telnet

Use the checkbox to Enable or Disable Telnet application on the MR-S2.

Update Firmware

These fields are provided to allow for software/firmware changes.

4.2.2 SNMP Configuration

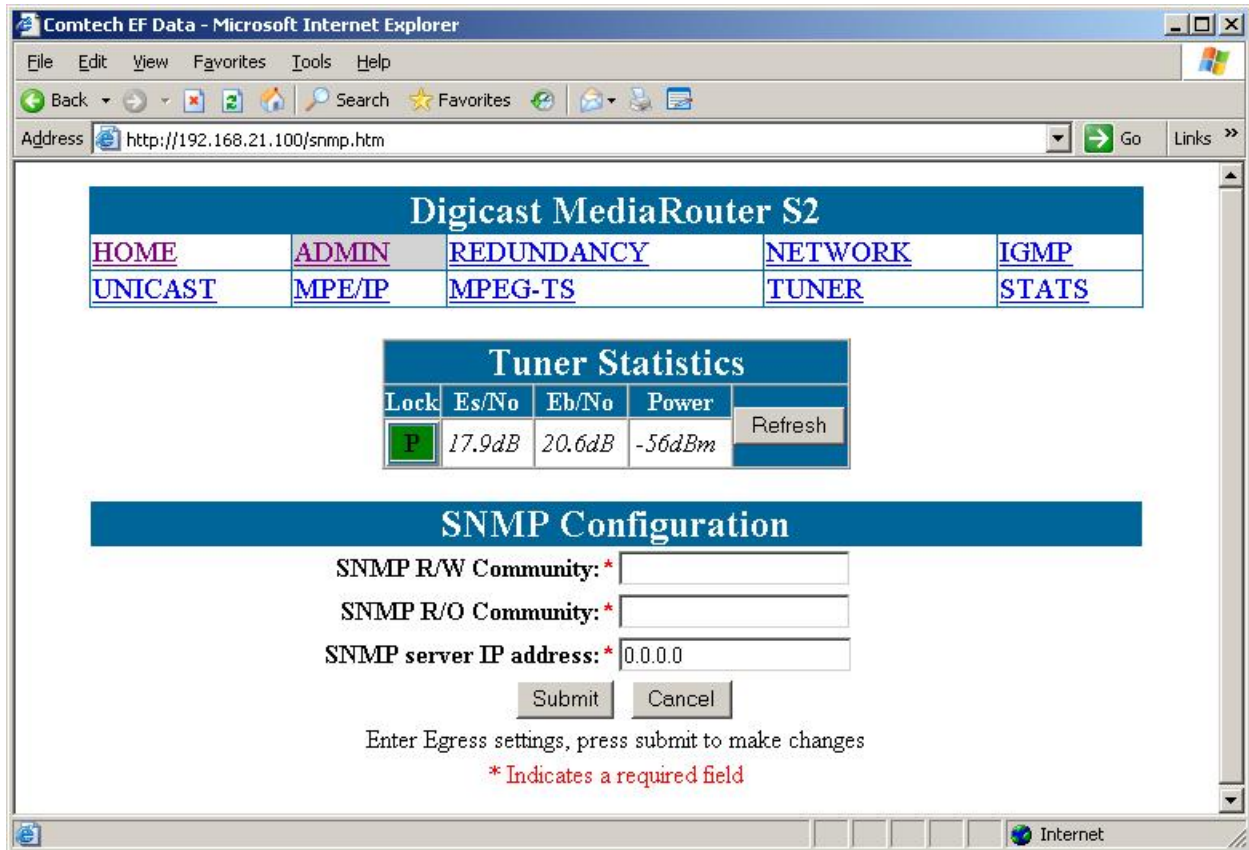

Figure 4-5. SNMP Configuration page

SNMP R/W Community

The community name for authentication for read/write access to the private MIB.

SNMP R/O Community

The community name for authentication for read only access to the private MIB.

SNMP Server IP Address

The IP address of the SNMP server for sending SNMP traps.

4.2.3 Vload Configuration

Vload is a system used to remotely update the MRS-2 receiver via multicast transmission. Please refer to the Digicast section of the Vload manual for information on how to use the head-end software component of Vload.

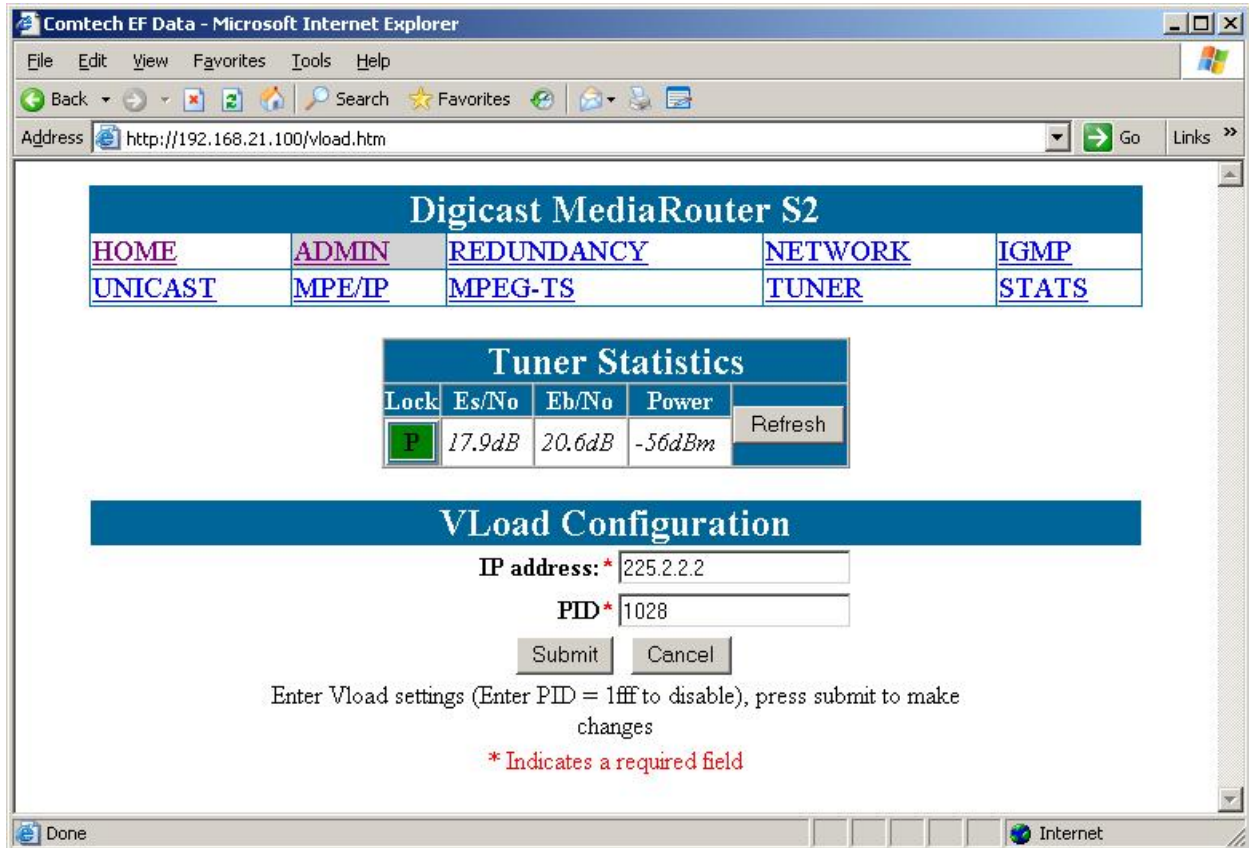

Figure 4-6. Vload Configuration Page

IP Address

The multicast address to be used for Vload.

Please note that the multicast address used here should **not be used in any other route settings**.

PID

Define the PID value (in hexadecimal format) to use for Vload.

Note: This PID value cannot be used or defined elsewhere on this receiver for carrying user data traffic.

4.2.4 Syslog Configuration

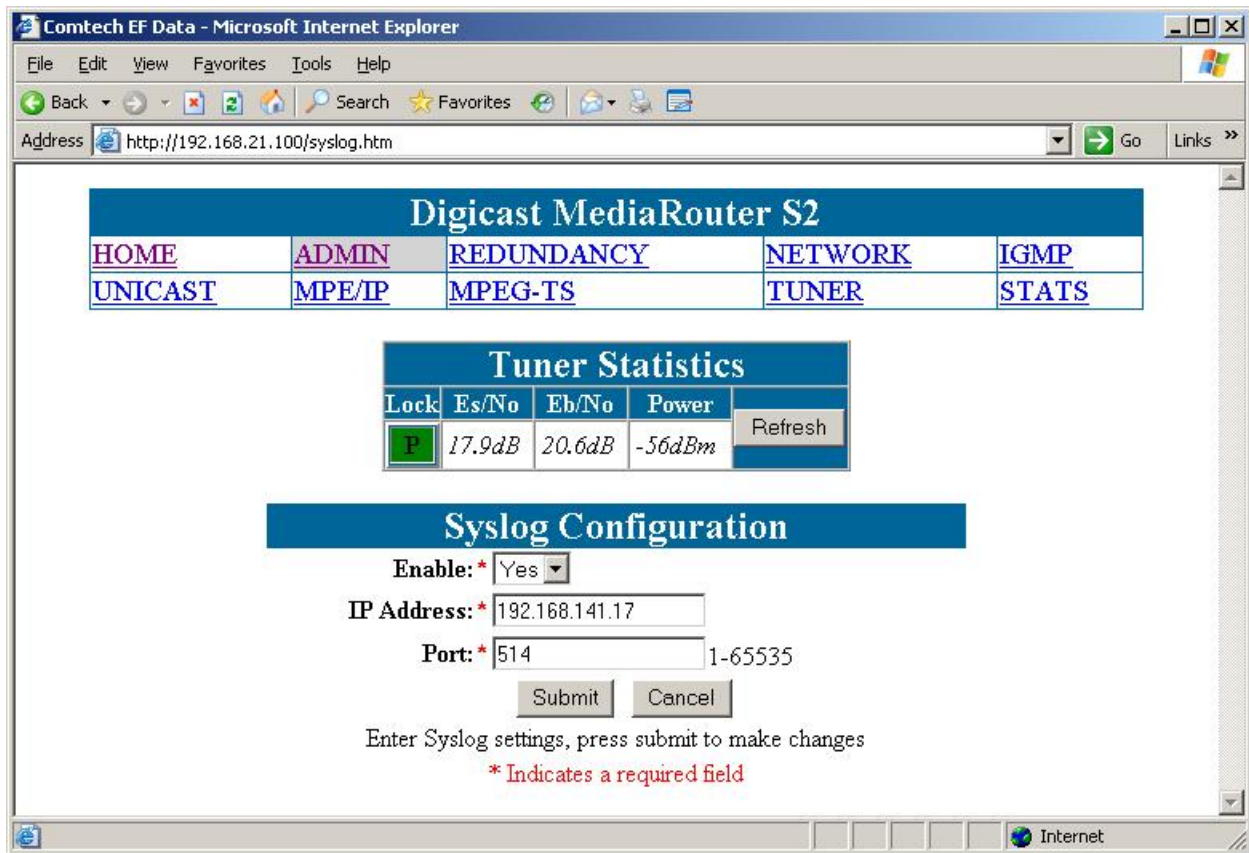

Figure 4-7. Syslog Configuration page

Syslog is a common feature of the Linux operating system. Syslog allows the events that occur on the MR-S2 to be sent to a server where they can be logged. The events are delivered to a configured server over Ethernet IP.

Enable

Enables or disables the Syslog feature.

IP Address

The IP address of the Syslog server.

Port

The port of the Syslog server. The default port number is **514**.

4.2.5 Redundancy Configuration

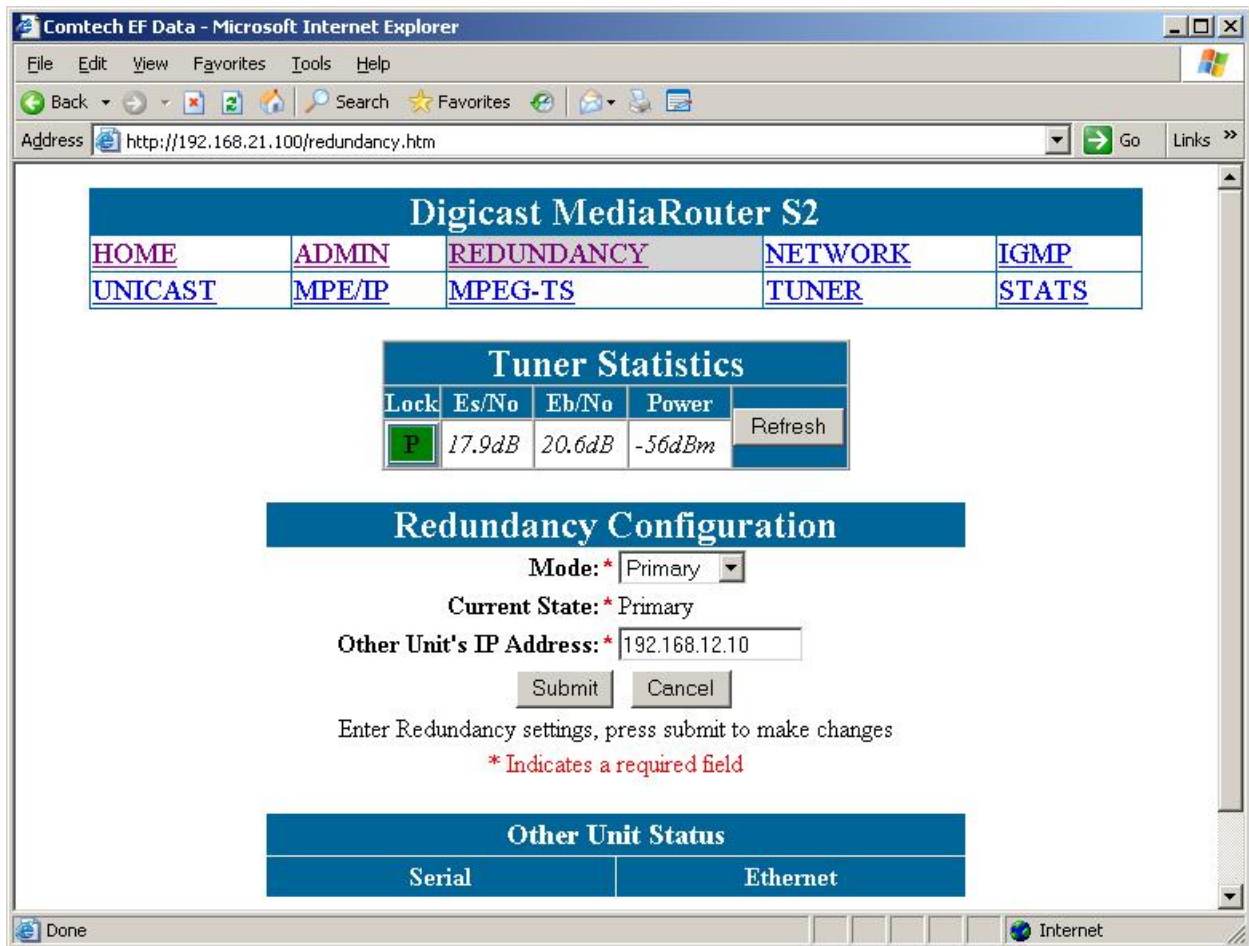

Figure 4-8. Redundancy Configuration page

Redundancy is available when two units are used to ensure reliable service in the event of failure of a unit. The units are configured in Primary/Backup roles and communicate between each other via serial cable (Part Number CA-0000011) connected to each unit's redundant port and via Ethernet.

Other Unit's IP Address

Enter the IP address of the unit to be used in conjunction with this unit for redundant functionality.

Mode

Select the mode of this receiver (Primary, Backup, Disabled). If two units are to be configured as a redundant system, then one unit must be "Primary" and the other must be "Backup". Please note that both units must be configured correctly (one as primary, the other as backup) in order for redundancy to function correctly.

4.2.6 Network Configuration

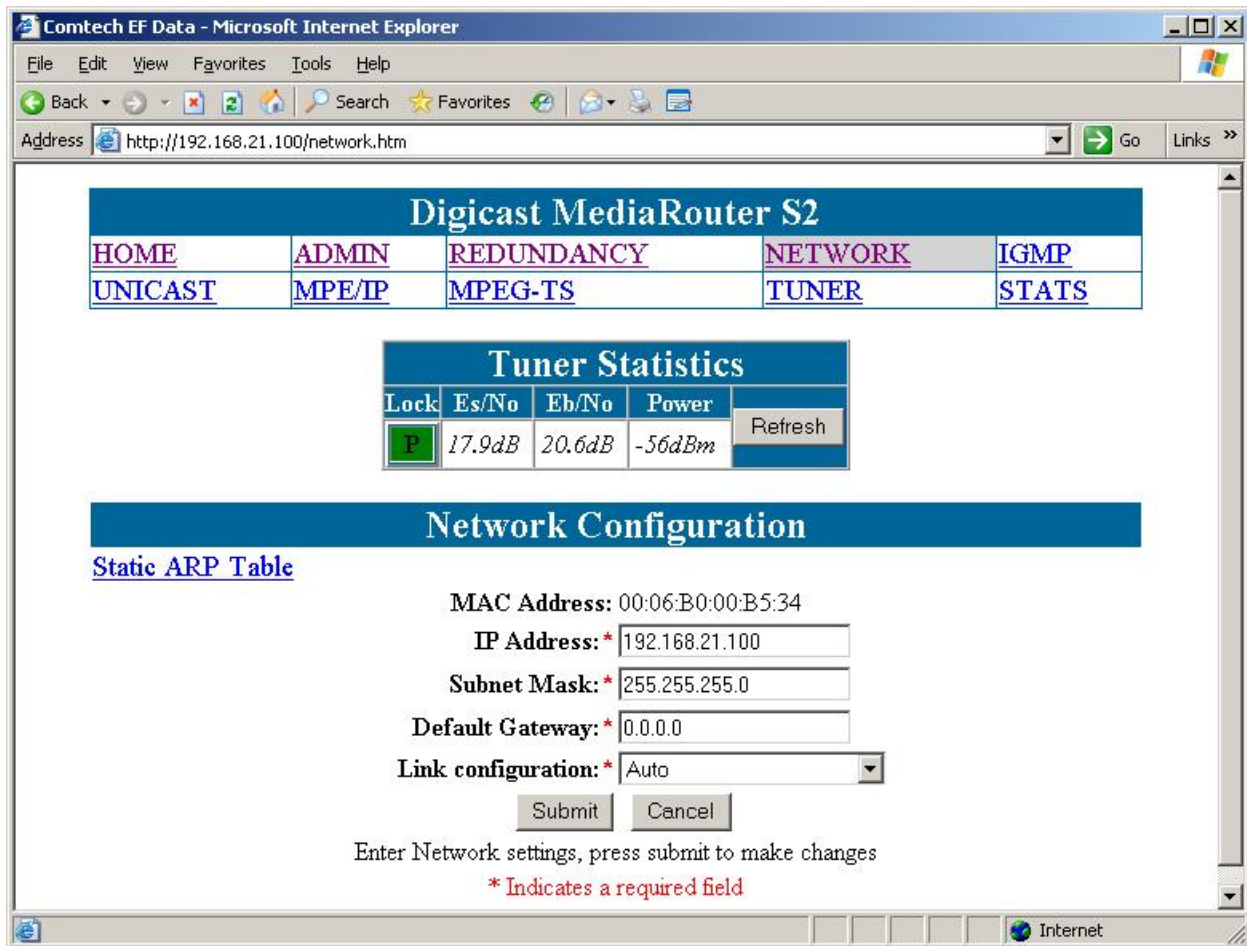

Figure 4-9. Network Configuration page

The Network Configuration page has the following configurable parameters:

IP Address

The IP Address assigned to the MR-S2's LAN interface. The IP Address is entered in dotted decimal format.

Subnet Mask

The Subnet Mask assigned to the MR-S2's LAN interface. The Subnet Mask is entered in dotted decimal format and is typically 255.255.255.0 for a C-Class mask, 255.255.0.0 for a B-Class mask or 255.0.0.0 for an A-Class mask.

Default Gateway

The Default Gateway assigned to the MR-S2's LAN interface. The Default Gateway is entered in dotted decimal format and must be within the subnet of the IP Address assigned to the LAN interface. The Default Gateway is the address of a local router to which all non-local subnet traffic will be directed.

Link Configuration

Select the line speed and duplex setting on the receiver's LAN interface.
The available options are:

- Auto – the port will auto-negotiate the configuration of the port
- 10 Mb / half duplex
- 10 Mb / full duplex
- 100 Mb / half duplex
- 100 Mb / full duplex

If the configuration of the port is unknown, then “Auto” is the recommended configuration.

4.2.7 Network ARP

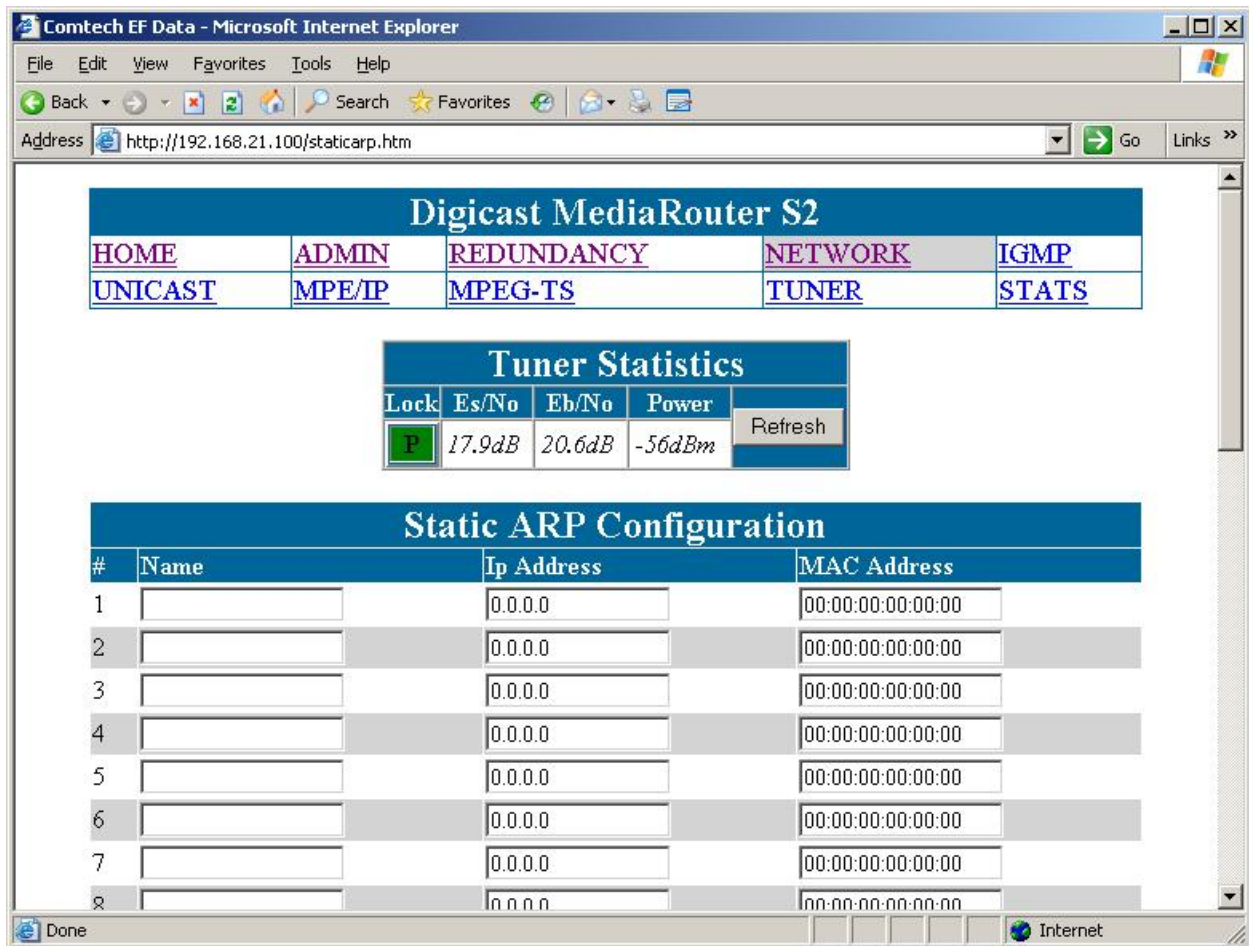

Figure 4-10. Network ARP Configuration page

The CMR-5975 allows the user to define a static ARP for a defined IP address. This mode should only be used when an IP flow is required to be directed to a particular MAC address.

Name

The name of the table entry.

IP Address

A valid IP address of a device on the network.

MAC Address

The MAC address associated with the IP address.

4.2.8 IGMP Configuration

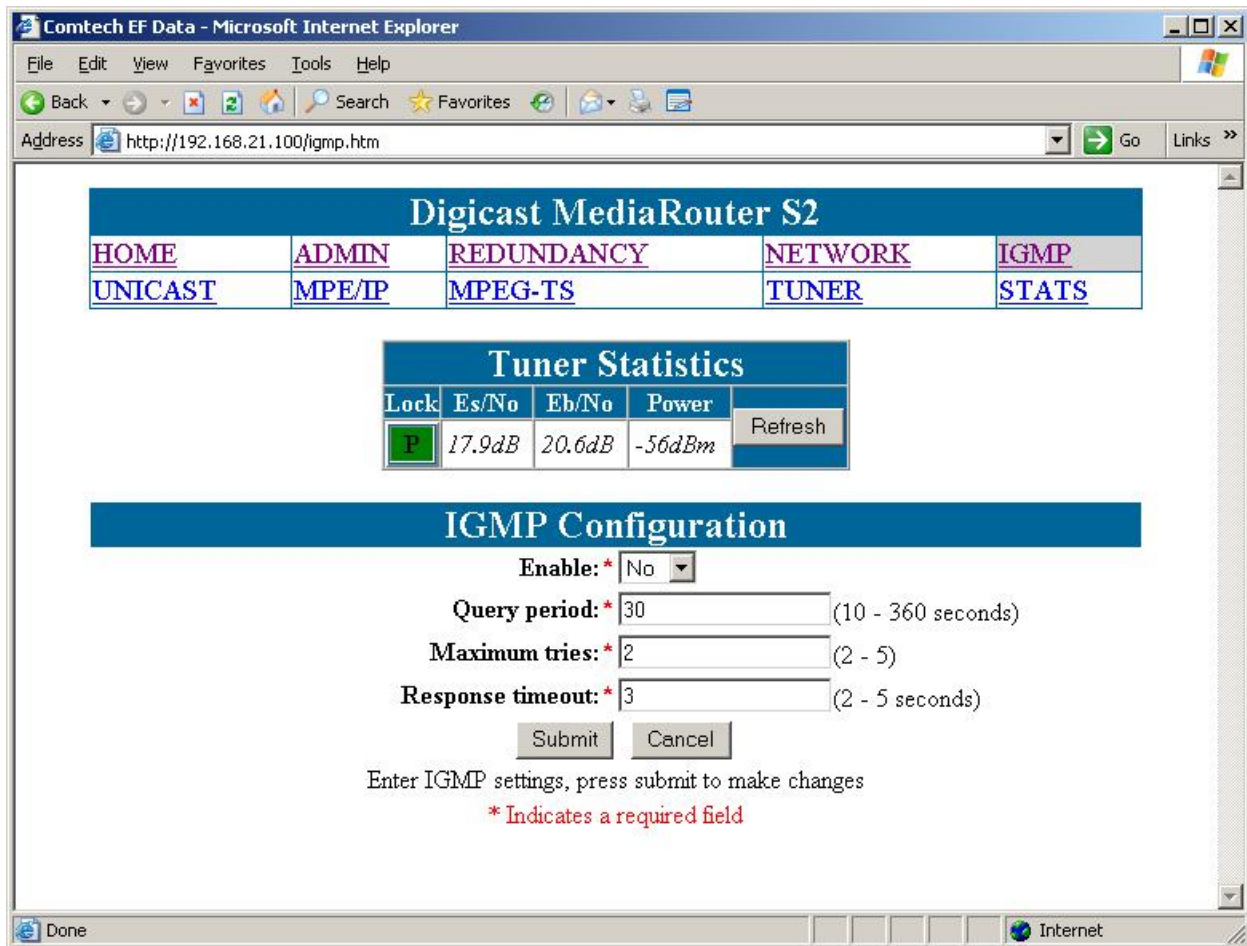

Figure 4-11. IGMP Configuration page

Enable

Select the Boolean if IGMP version 2 (IGMPv2) is to be supported. If the Boolean is not selected, all received Multicast IP is forwarded to the Ethernet, but if support is enabled, no Multicast IP will be forwarded to the Ethernet, until a subscriber has joined the Multicast group.

Query Period

How often a solicitation is made for Multicast subscribers.

Maximum Tries

The maximum number of attempts the MR-S2 will make for soliciting for Multicast subscribers before the Multicast stream is pruned off.

Response Timeout

The maximum amount of time the MR-S2 will wait for a Multicast Subscribers before the Multicast stream is pruned off.

4.2.9 Unicast Routing Configuration

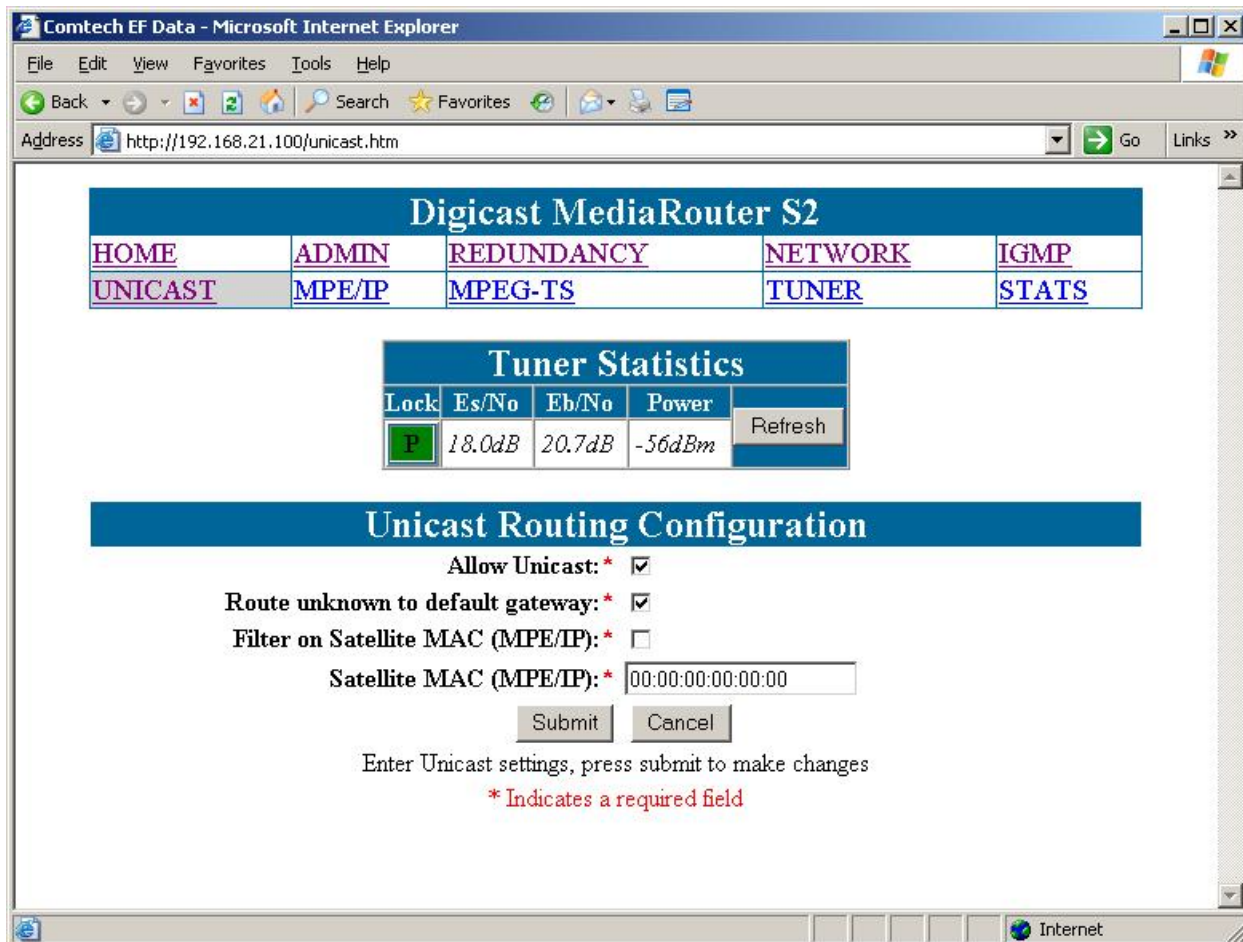

Figure 4-12. Unicast Routing Configuration page

The Unicast Routing Configuration page addresses the MR-S2's configuration for handling Unicast traffic over the transport stream. This feature is only used in the MPE/IP configuration.

Allow Unicast

Selects whether the MR-S2 will support the routing of Unicast traffic.

Route unknown to default gateway

When selected, all incoming Unicast that is not destined for the CMR local network subnet will be directed to the configured default gateway.

Filter on Satellite MAC (MPE/IP)

The hardware Media Access Control (MAC) address assigned for Unicast operation. When the satellite MAC is defined, the MR-S2 will only route Unicast traffic that is specifically addressed to the satellite MAC. This value does not affect the characteristics of multicast data flow.

Digicast receivers do not need to filter on MAC. Some third party encapsulators/receivers may need to filter on MAC, and if the MAC is configured on the Encapsulator for a Unicast Route, do not use the CMR-5975 Ethernet MAC – you will need to create your own MAC.

Satellite MAC (MPE/IP)

The hardware Media Access Control (MAC) address assigned for Unicast operation. When the satellite MAC is defined, the MR-S2 will only route Unicast traffic that is specifically addressed to the satellite MAC. This value does not affect the characteristics of multicast data flow.

4.2.10 MPE/IP Configuration

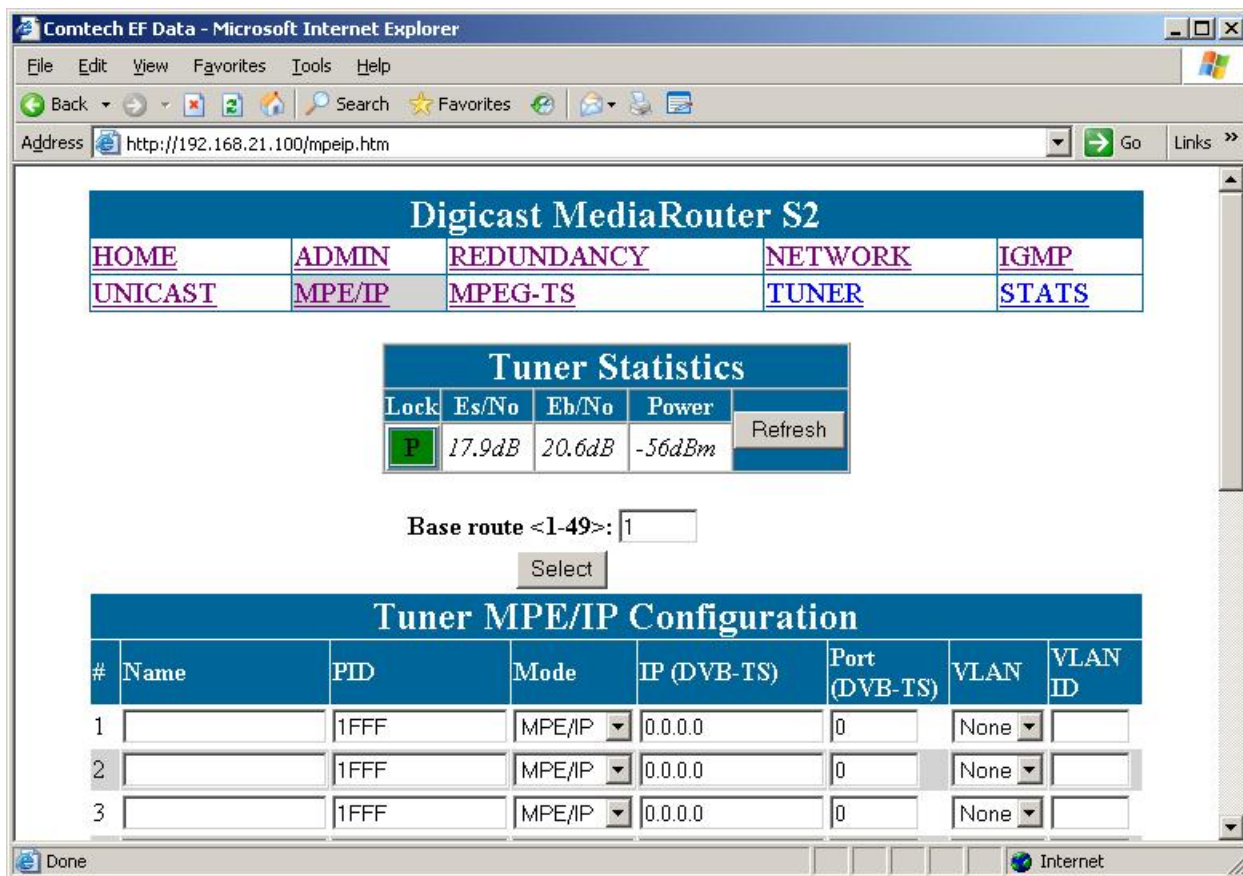

Figure 4-13. MPE/IP Configuration page

A configured PID value in hexadecimal is required for MPE/IP data to be extracted from the transport stream and sent to the CPU. Once a valid PID value is configured, and data is found on a transport stream, the data is decapsulated and delivered to the Ethernet port. A value of 0x1FFF is disabled.

Name

User defined name (cannot contain spaces)

PID

A valid PID in hexadecimal format, ranging from 0x10 to 0x1FFE (0x1FFF disables the item). The PID value cannot be in use elsewhere on the receiver.

Mode

MPE/IP or DVB-TS

IP (DVB-TS)

If DVB-TS Mode is selected, then a valid IP address is required. This is the destination IP address, and can be either multicast or unicast.

Port (DVB-TS)

If DVB-TS Mode is selected, then a valid destination port is required.

VLAN

Options are All, ID, or None

VLAN ID

VLAN ID tag from the originating point

4.2.11 Tuner MPEG TS Route Configuration

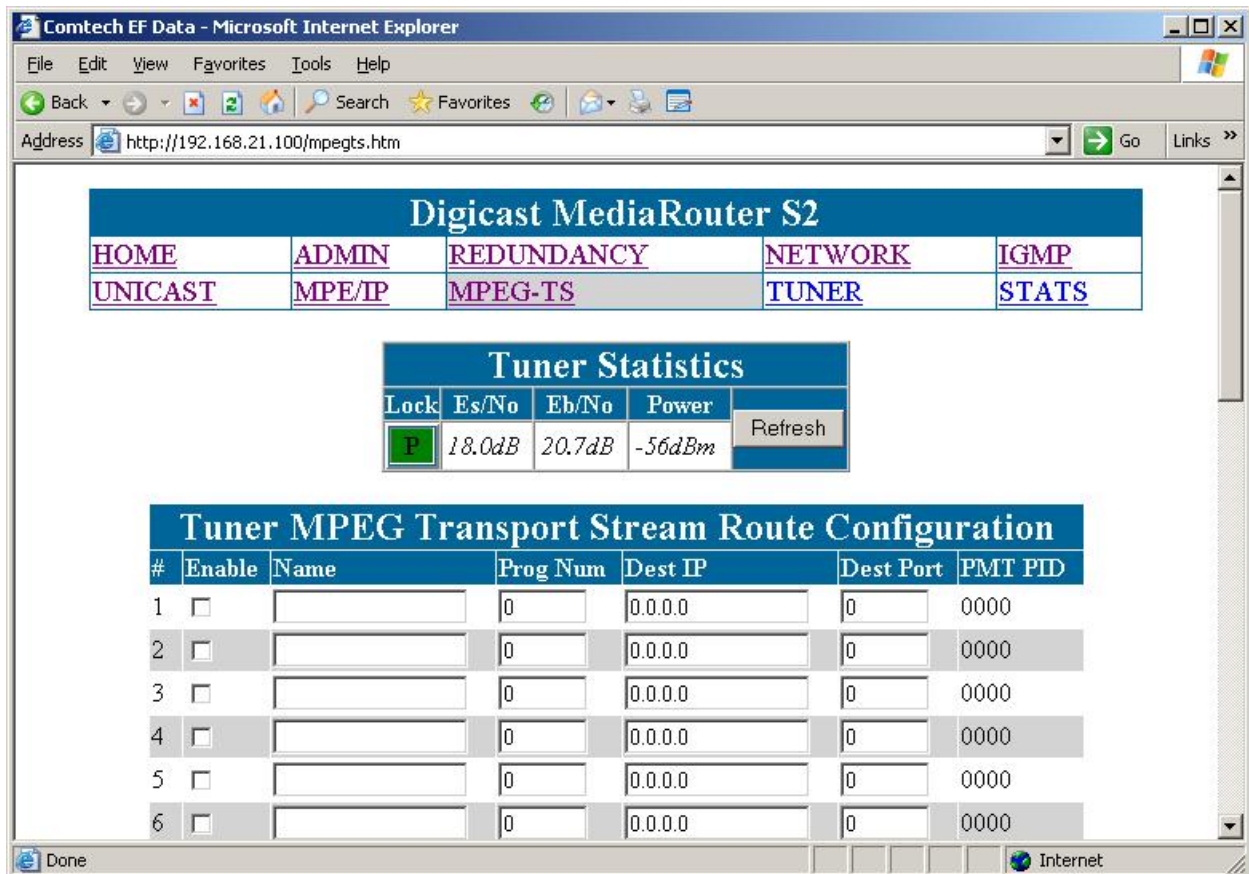

Figure 4-14. Tuner MPEG TS Route Configuration (full) page

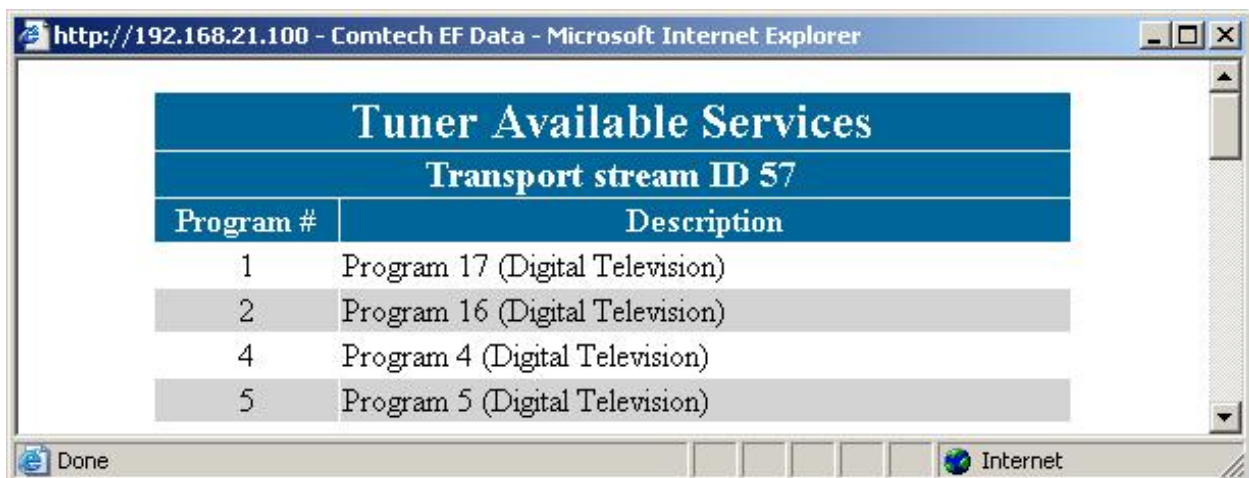

Figure 4-15. Tuner Available Configuration page (headers and dialogue box)

Select the “Service List” button at the bottom of the page to see all services on the particular input. This is achieved by looking at the Program Stream Information (PSI) that is contained in the Program Association Table (PAT) and Program Mapping Table (PMT) – all detected programs will be displayed for either input port selected.

Enable

Enables or disables the route.

Name

The name of the incoming program that is extracted from the Program Service Information.

Program Number

The program number, as defined in the service list, to be routed to the Ethernet as Transport Stream over IP.

PMT PID Number

The PMT PID to be routed to the Ethernet as Transport Stream over IP.

Destination IP

The IP address to be used when routing the Transport Stream over Ethernet IP.

Port Number

The Port Number to be used when routing the Transport Stream over Ethernet IP.

4.2.12 Tuner Configuration

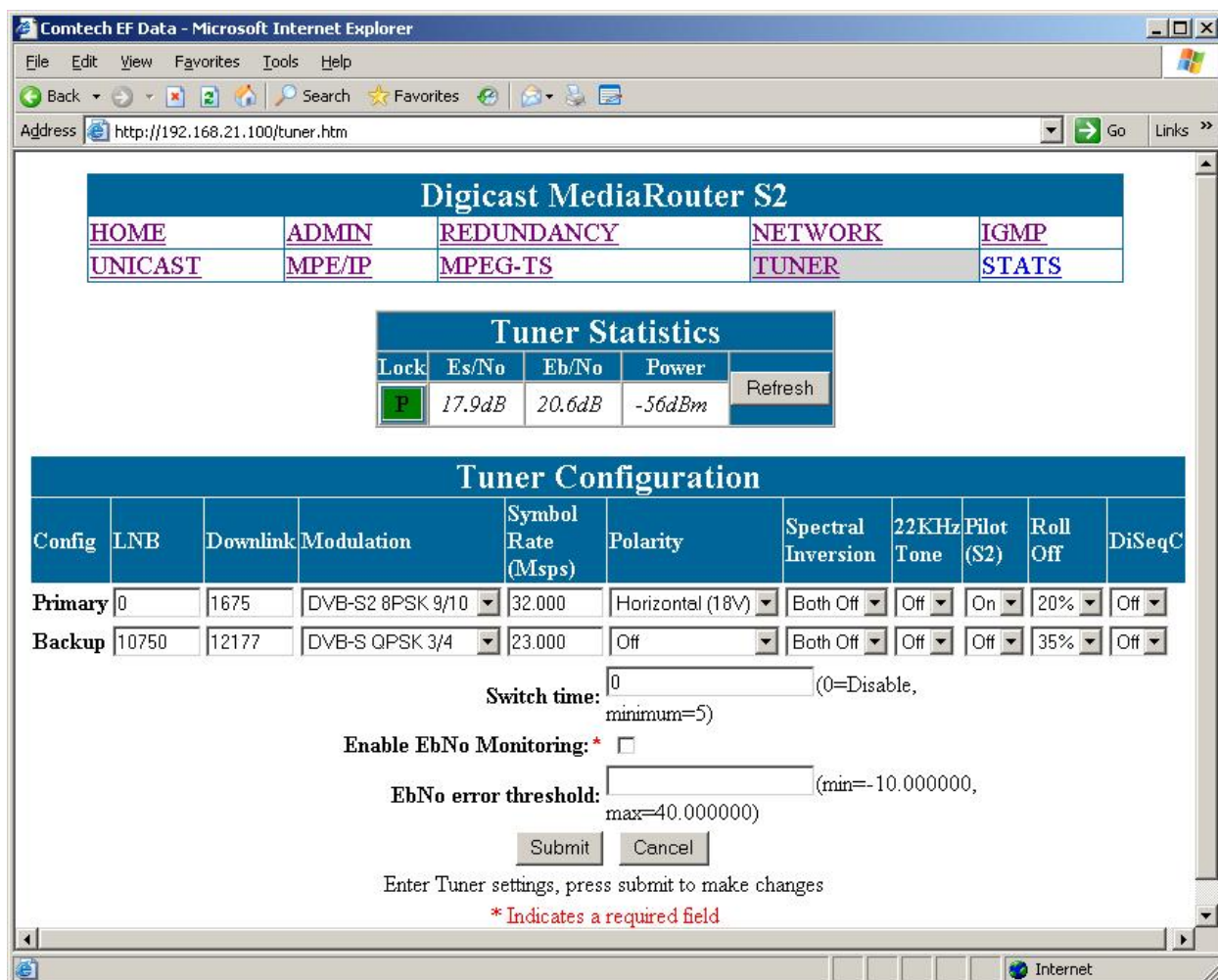

Figure 4-16. Tuner Configuration page

Primary and Backup Tuner Configuration

The MR-S2 can be configured to have a backup (secondary) configuration. The secondary tuner configuration allows the user to configure a backup configuration in the event the main carrier is taken down. The MR-S2 will only attempt to use the **secondary configuration in the** event the primary carrier is not available, and if a switch time of greater than 0 (zero) is set. If the **unit is unable to lock to the** backup tuner settings, the unit will continue to switch between backup and primary frequencies based on the switch time until lock is achieved.

LNB Frequency

The frequency of the Local Oscillator (LO) that resides in the Low Noise Block (LNB) amplifier located at the antenna. For Ku-Band operation, the LO is typically 10,750 MHz for Ku-Band operation North America and other common frequencies are 9,750 MHz and 10,600 MHz. For C-Band operation, 5,150 MHz is a common LO frequency. Please consult your LNB manufacturer for the LO in the LNB.

Downlink Frequency

The actual receive frequency being down linked from the satellite to the Low Noise Block (LNB) amplifier located at the antenna. For Ku-Band operation, this frequency ranges from 10,700 MHz to 12,750 MHz. For C-Band operation, this frequency ranges from 3,400 MHz to 4,200 MHz.

The combination of the LO and the downlink frequency produce the L-Band frequency expected by the MR-S2. Some examples are as follows:

Example 1:

LO = 10,750 MHz

Ku-Band Receive Frequency = 11,895 MHz

L-Band Frequency = 11,895 MHz – 10,750 MHz

L-Band Frequency = 1,145 MHz

Example 2:

LO = 10,600 MHz

Ku-Band Receive Frequency = 12,010 MHz

L-Band Frequency = 12,010 MHz – 10,600 MHz

L-Band Frequency = 1,410 MHz

Example 3:

LO = 5,150 MHz

C-Band Receive Frequency = 3,920 MHz

L-Band Frequency = 5,150 MHz – 3,920 MHz

L-Band Frequency = 1,230 MHz

Modulation

The MR-S2 supports the following modes of operation:

- DVB-S – QPSK
- DVB-S2 – QPSK
- DVB-S2 – 8PSK

Each mode of operation provides a range of FEC rates that are supported based on the mode and modulation.

Symbol Rate

Depending on the configured mode of operation, the following symbol rates are supported:

- DVB-S – QPSK 2 to 45 Msps
- DVB-S2 – QPSK 2 to 32 Msps
- DVB-S2 – 8PSK 2 to 32 Msps

Polarity

The configured polarity provides the voltage supplied to the LNB or switch. The valid selections for the MR-S2 are 13 VDC for vertical polarization and 18 VDC for horizontal polarization. The MR-S2 is capable of providing up to 600mA of current in either mode of operation. It is recommended, that if the LNB voltage is not required, that a DC block be installed.

Spectral Inversion

There are four supported modes of spectral inversion:

- **On** – forces the tuner to stay with spectral inversion. The tuner will not check for spectral inversion automatically
- **Off** – forces the tuner to stay without spectral inversion. The tuner will not check for spectral inversion automatically
- **On Both** – tries spectral inversion first and then attempts to automatically check spectral inversion periodically
- **Off Both** – tries non-spectral inversion first and then attempts to automatically check spectral inversion periodically

LNB 22 KHz Tone

Enables or disables the LNB 22 KHz tone to the LNB for remote LNB and switch control.

Pilot

Enables or disables the Pilot for DVB-S2 mode of operation only.

Roll Off

The expected filter roll off of the carrier the receiver should be looking at. This parameter only works for DVB-S2 mode, since DVB-S mode uses a fixed roll off of 35%.

The valid roll offs in DVB-S2 mode are:

- 20%
- 25%
- 35%

DiSEqC

Enables sending and receiving DiSEqC commands as are supported in DiSEqC mode 1.2. The valid configuration settings for DiSEqC mode are:

- Off
- Mode A
- Mode B
- Mode C
- Mode D

Switch Time

The number of seconds the unit should wait before attempting to locate the backup carrier. If set to disabled (by setting to a value of 0 (zero)), the MR-S2 will not attempt to switch to a backup carrier.

4.2.13 Tuner Statistics

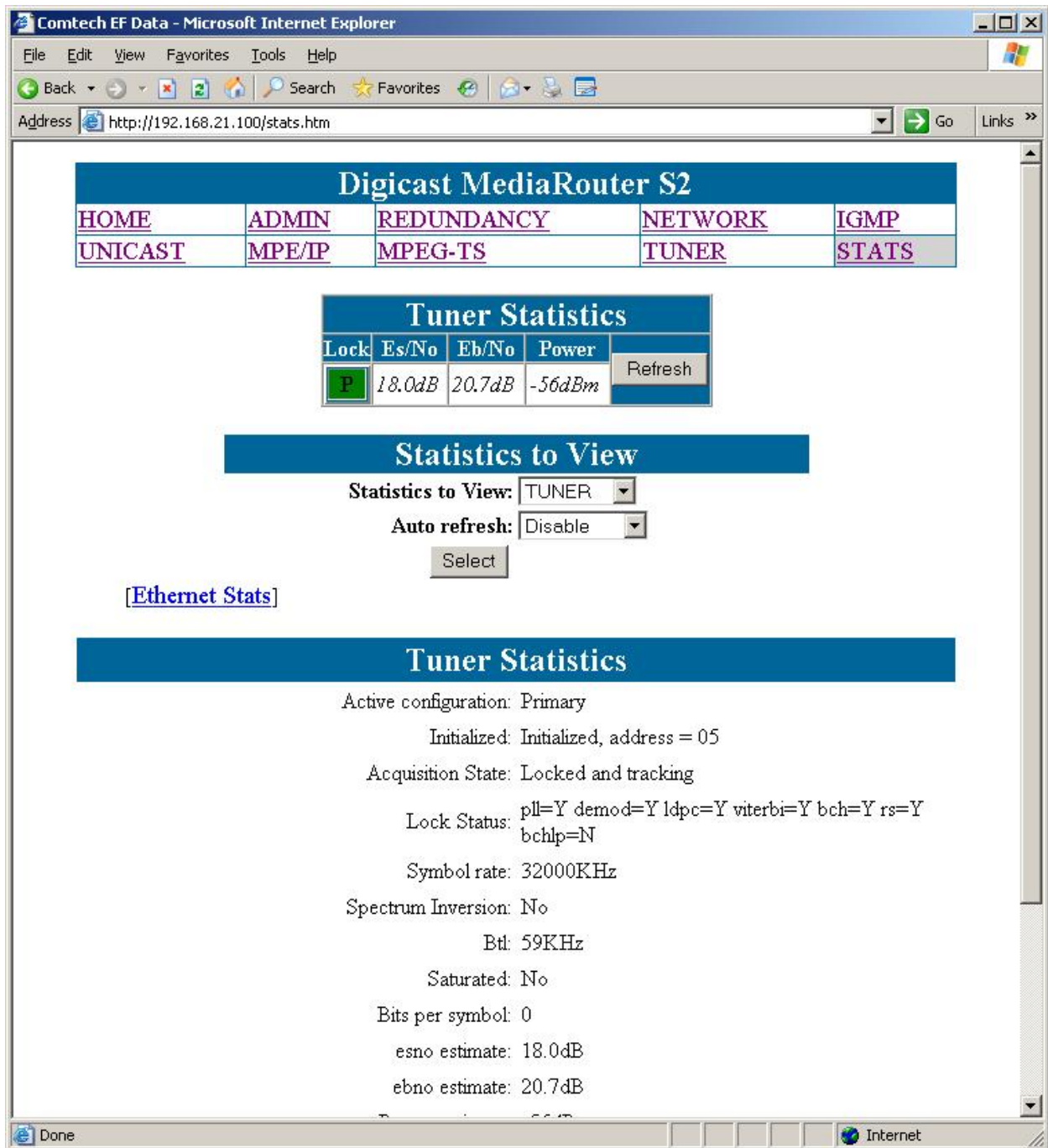

Figure 4-17. Tuner Statistics page

Statistical reports are available from the MR-S2 using this menu.
The available report options are:

- MPE/IP
- MPEG TS
- Tuner

When selected, the statistics displayed on screen are automatically refreshed so the user does not have to constantly refresh the screen.

These detailed tuner statistics can be used to troubleshoot problems with a satellite link. The available parameters are as follows:

Active Configuration

Displays whether the tuner is running with the Primary or Backup configuration.

Initialized

Displays whether the tuner is initialized or not. The I2C address where the processor found the tuner is displayed.

Acquisition State

Displays whether the tuner is locked and tracking or whether the tuner is unlocked.

Lock Status

Displays the lock status of various components in the tuner:

- PLL – Phase Lock Loop
- Demodulator
- LDPC Decoder
- Viterbi Decoder
- BCH Decoder
- Reed Solomon Decoder
- BCHLP Decoder

Symbol Rate

Displays the configured symbol rate.

Spectrum Inversion

Displays the state of the spectrum which the tuner locked to either **inverted** or **non-inverted**.

BTL

Displays the status of the BTL.

Es/No

Displays the Es/No (Symbol Energy over the Noise Density).

Eb/No

Displays the Eb/No (Energy per Bit to Noise Power Spectral Density Ratio).

Power Estimate

Displays the received port input level. This level must be between -50 dBm to -25 dBm for proper operation.

Bits per Symbol

Displays the number of bits per symbol.

Corrected Bit Error Rate

Displays the corrected bit error rate coming from the tuner. Corrected data does not result in any lost user data.

Uncorrected Bit Error Rate

Displays the uncorrected bit error rate coming from the tuner. These are bit errors that could not be corrected and result in lost user data.

Window Adjustment

Displays the adjustment the tuner used to capture the incoming carrier.

CRC Error Rate

Displays the Cyclic Redundancy Check (CRC) error rate received over the satellite.

4.3 Terminal Interface

The Terminal Interface provides the user with a textual configuration dialog for configuring the MR-S2. This method of configuration should be used for initial configuration of the unit; i.e., configuring the network parameters for the unit but *not* for normal operation. The Web (HTTP) Interface is recommended for operational management.

The Terminal Interface allows the entire unit to be configured and managed, but this interface can only be used while a serial connection is present between the MR-S2 and a PC. The screens shown in this section are displayed via a Telnet connection.

The user must authenticate (login) before being able to access the application. After a period of inactivity, the user's session will time out, and must log in again to resume.

The same menu information is displayed via the serial interface with some specific features only available via this access method – these 'serial interface only' features are noted in this section. Detailed information is provided about the menu features in **Chapter 4.2 Web Interface**.

Figure 4-18 shows the hierarchal structure of the Terminal Interface-based menus and the sections in this chapter which provide figures of these submenu pages.

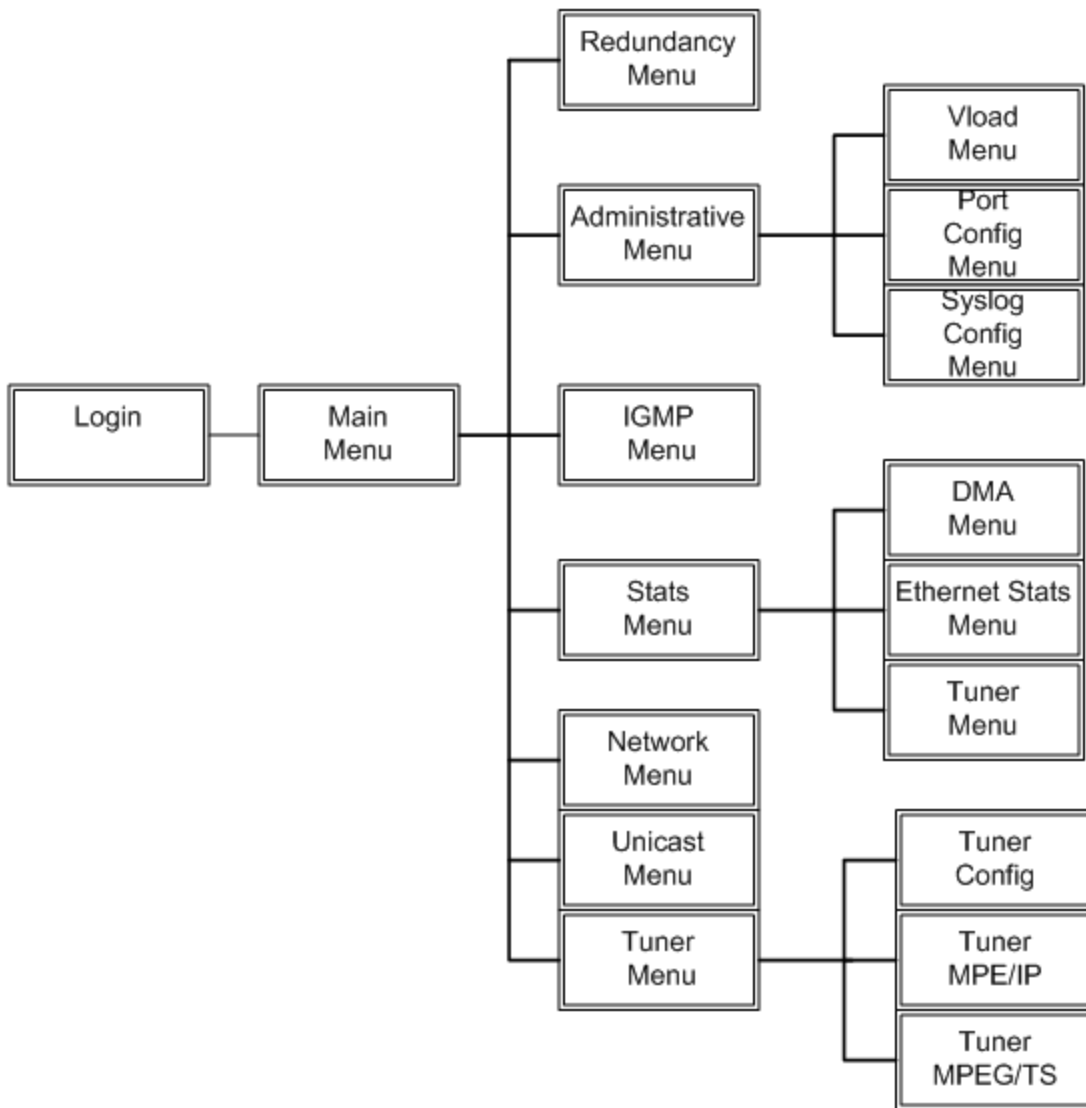

Figure 4-18. Menu Hierarchy (via Terminal Interface)

Once the terminal interface is connected, as described in **Chapter 2.4 Initial Configuration**, press the <ENTER> key. The user should observe the Login screen, and after a successful login, the Main Menu as shown in 4-20. Main Menu

4.3.1 Login

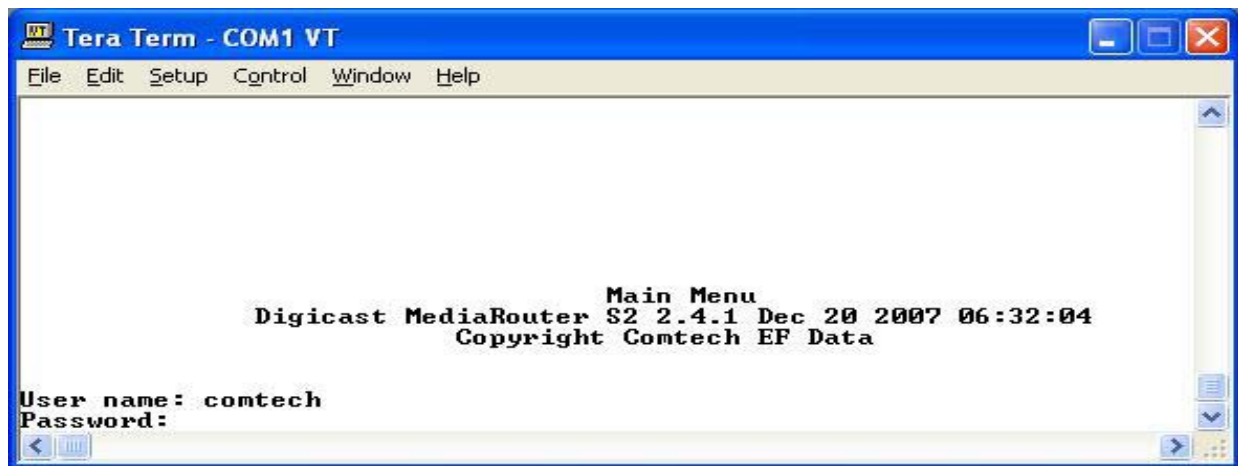

Figure 4-19. Login Prompt

The login prompt is displayed upon entry via Telnet or a serial connection. The default user name is “*comtech*”, and the default password is “*comtech*” (case sensitive).

4.3.2 Main Menu

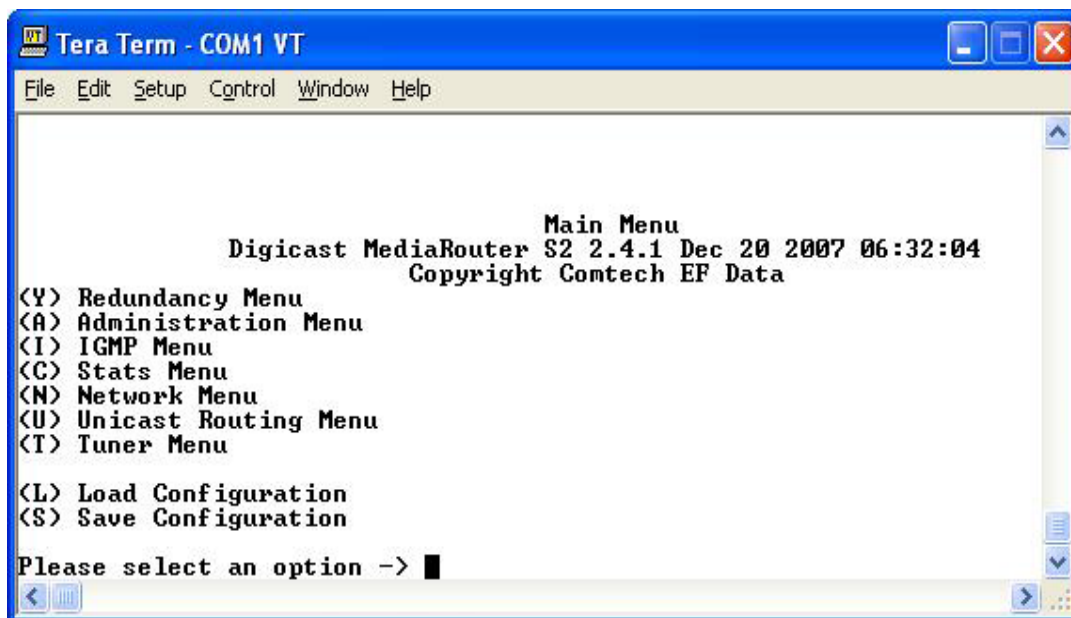

Figure 4-20. Main Menu

The Main Menu utilizes different menus for the command line interface to access the various configuration settings and statistics on the MRS-2 receiver.

4.3.3 Redundancy Menu

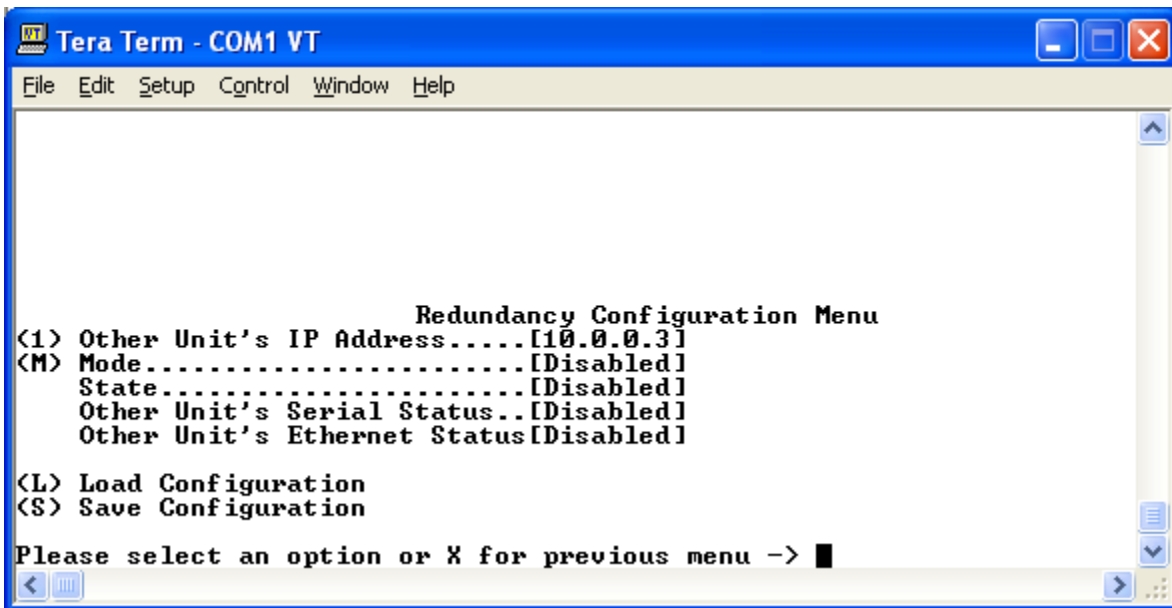

Figure 4-21. Main Menu

Redundancy is available when two units are used to ensure reliable service in the event of a failure or loss of signal. The units are configured in Primary/Backup roles and communicate between each other via cable connected to each unit's redundant port.

Other Unit's IP Address

Enter the IP address of the unit to be used in conjunction with this unit for redundant functionality.

Mode

Select the mode of this receiver (Primary, Backup, Disabled).

4.3.4 Administration Menu

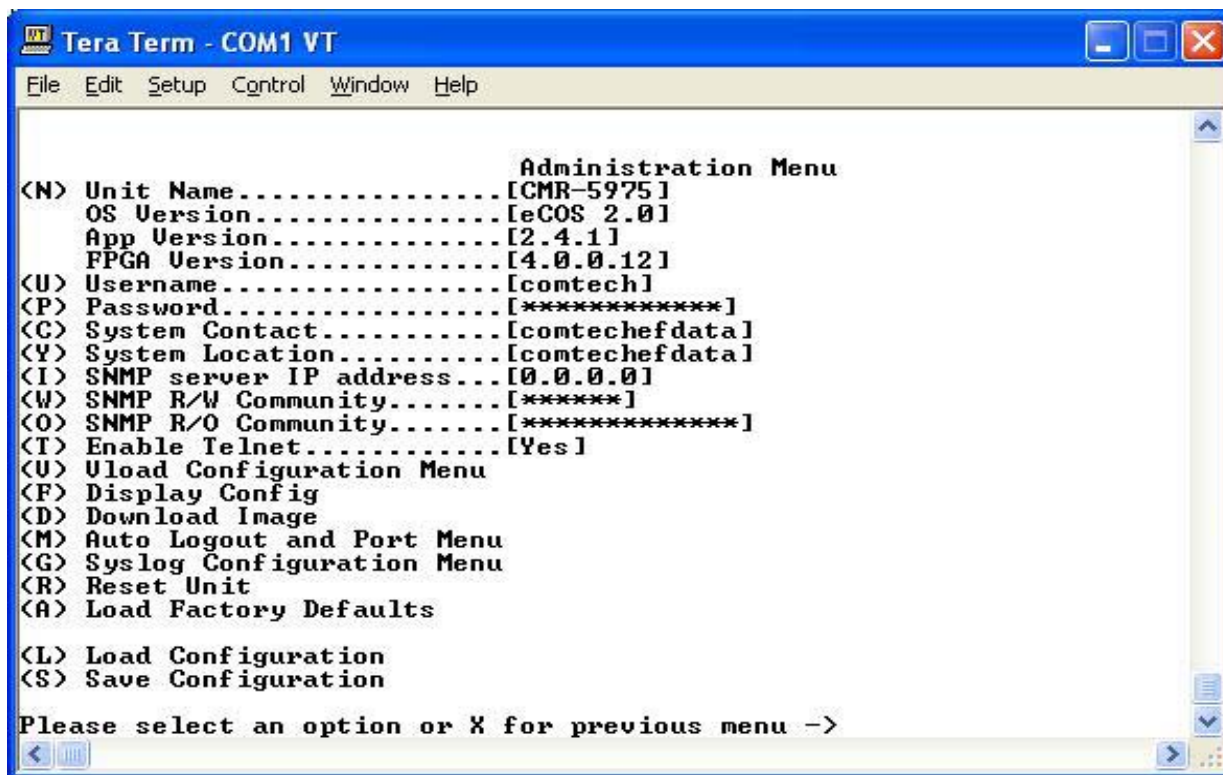

Figure 4-22. Admin Menu

The MR-S2 Administrative Configuration page contains the following configurable parameters:

Unit Name

The name of this receiver.

User Name

The MR-S2's User Name is user configurable and is used for connecting to the unit via IP management services.

The default user name is “comtech”.

Password

The MR-S2's Password is user configurable and is used for authenticating a user when connecting via IP management services.

The default password is “comtech”. The password is case sensitive and must be entered carefully.

When the password is changed, the user will be prompted to enter the password **twice** to verify it is correct.

System Contact

Contact information of the system administrator for support.

System Location

The physical location where the unit has been installed.

SNMP IP Address

Defines the SNMP server where traps are sent.

SNMP R/W Community

The community name for authentication for read/write access to the private MIB.

SNMP R/O Community

The community name for authentication for read only access to the private MIB.

Enable Telnet

Enables Telnet application on the MR-S2.

Display Config

Outputs the overall configuration of the receiver (verbose).

Download Image

Allows software/firmware changes to be made. User name and password is required for security.

Reset Unit

Reboots the receiver.

Load Factory Defaults

Resets all settings (except network) to factory default settings.

4.3.4.1 Vload Configuration Menu

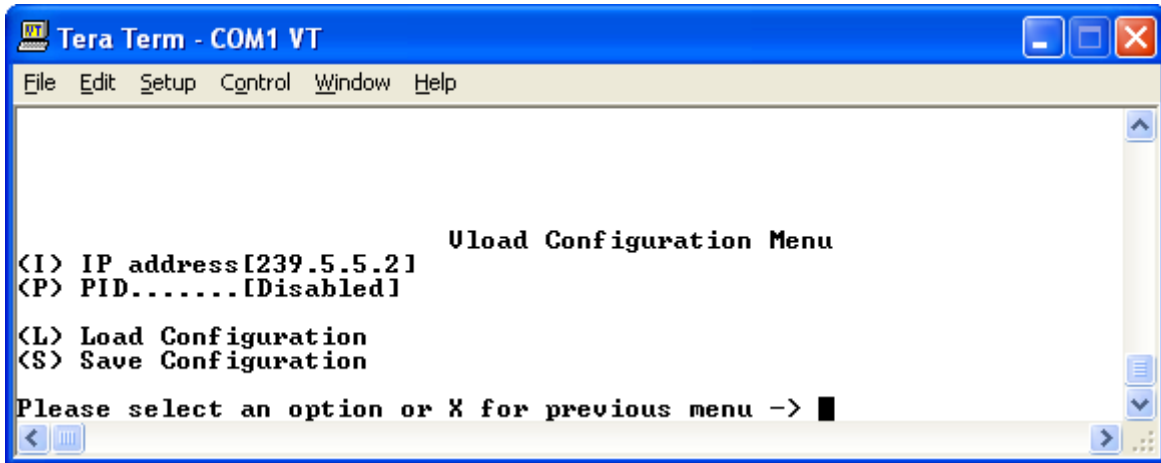

Figure 4-23. Vload Menu

Vload is a system used to remotely update the MRS-2 receiver via multicast transmission. Please refer to the Digicast section of the Vload manual for information on how to use the head-end software component of Vload.

IP Address

The multicast address to be used for Vload. Please note that the multicast address used here should **not be used in any other route settings**.

PID

Define the PID value (in hexadecimal format) to use for Vload.

Note: This PID value cannot be used or defined elsewhere on this receiver.

4.3.4.2 Port Number Configuration

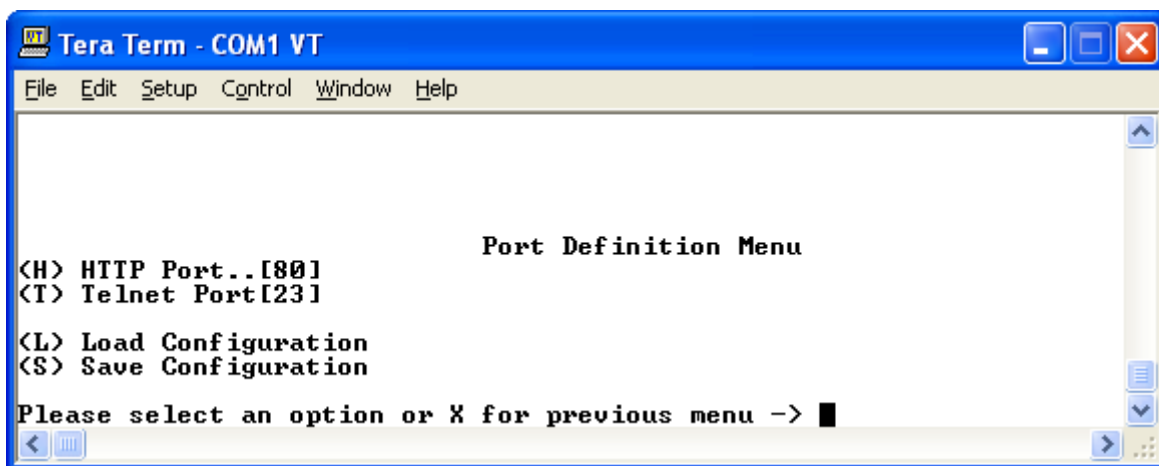

Figure 4-24. Main Menu

In addition to the features illustrated, one additional feature is available, for security reasons, via the serial interface only. Modifying the port numbers prevents attacks on “well known” ports by devices known as port scanners. This feature is configuration of the TCP Port number for Telnet and HTTP protocols. Option <M> allows the operator to modify the standard port numbers for Telnet (23) and HTTP (80) to prevent unauthorized access to the device. Care should be taken not to use a reserved standard port number.

4.3.4.3 Syslog Configuration Menu

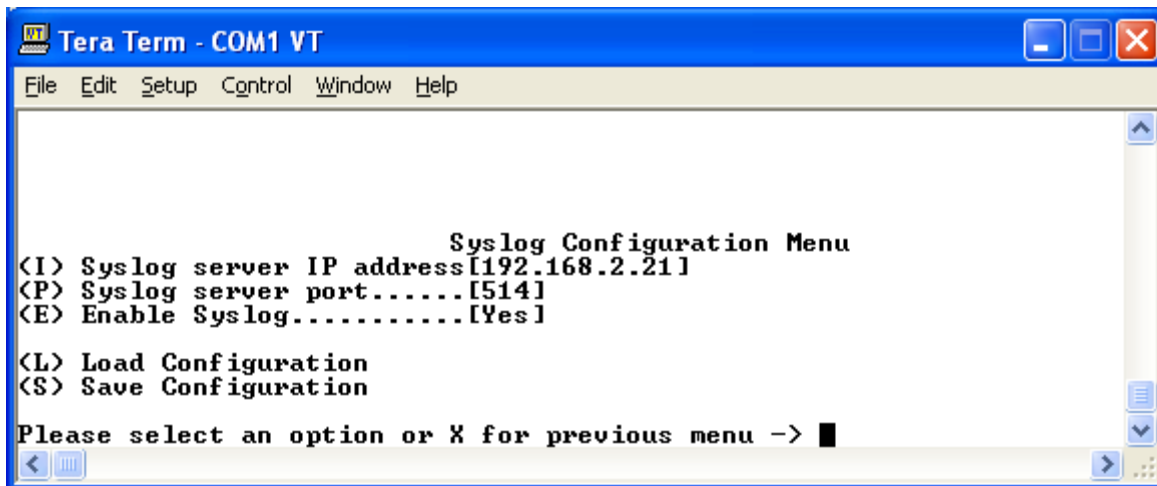

Figure 4-25. Main Menu

Syslog is a common feature of the Linux operating system. Syslog allows the events that occur on the MR-S2 to be sent to a server where they can be logged. The events are delivered to a configured server over Ethernet IP.

IP Address

The IP address of the Syslog server.

Port

The port of the Syslog server. The default port number is **514**.

Enable

Enables or disables the Syslog feature.

4.3.4.4 Load Factory Defaults

The Load Factory Defaults allows the user to restore the unit to the original configuration as it was set up before leaving the factory. This feature should be used with caution, since all configured settings, including usernames and passwords, will be removed.

4.3.5 IGMP Configuration Menu

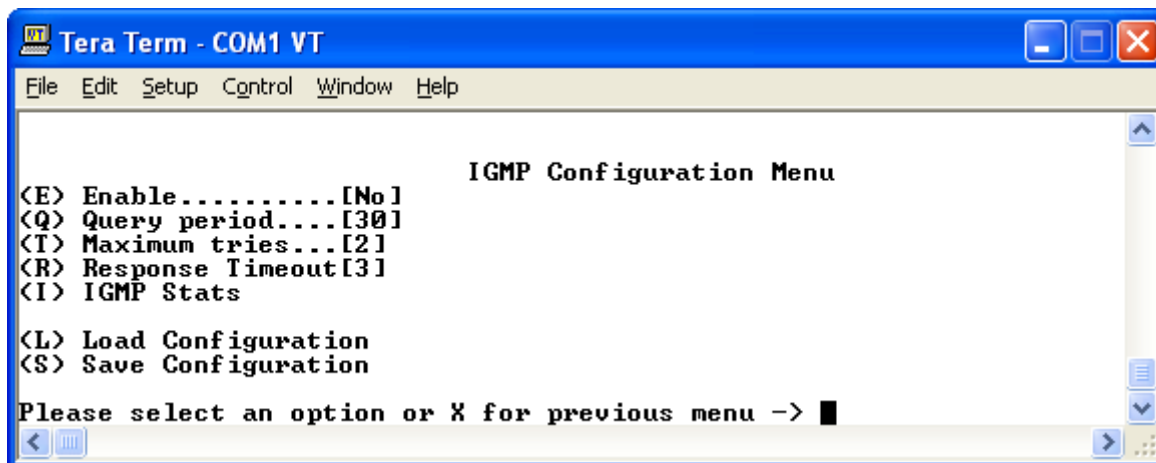

Figure 4-26. IGMP Configuration Menu

Enable

Select the Boolean if IGMP version 2 (IGMPv2) is to be supported. If the Boolean is not selected, all received Multicast IP is forwarded to the Ethernet, but if support is enabled, no Multicast IP will be forwarded to the Ethernet, until a subscriber has joined the Multicast group.

Query Period

How often a solicitation is made for Multicast subscribers.

Maximum Tries

The maximum number of attempts the MR-S2 will make for soliciting for Multicast subscribers before the Multicast stream is pruned off.

Response Timeout

The maximum amount of time the MR-S2 will wait for a Multicast Subscribers before the Multicast stream is pruned off.

4.3.6 Stats Menu

Figure 4-27 shows the hierarchal structure of the Terminal Interface-based Stats menus and the sections in this chapter which illustrate the menu pages within this hierarchy.

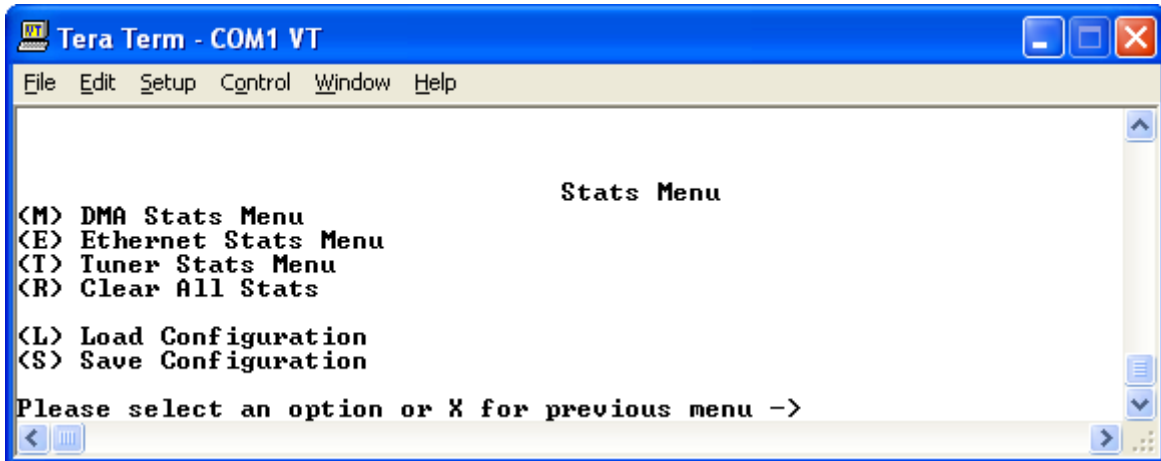

Figure 4-27. MR-S2 Stats Menu

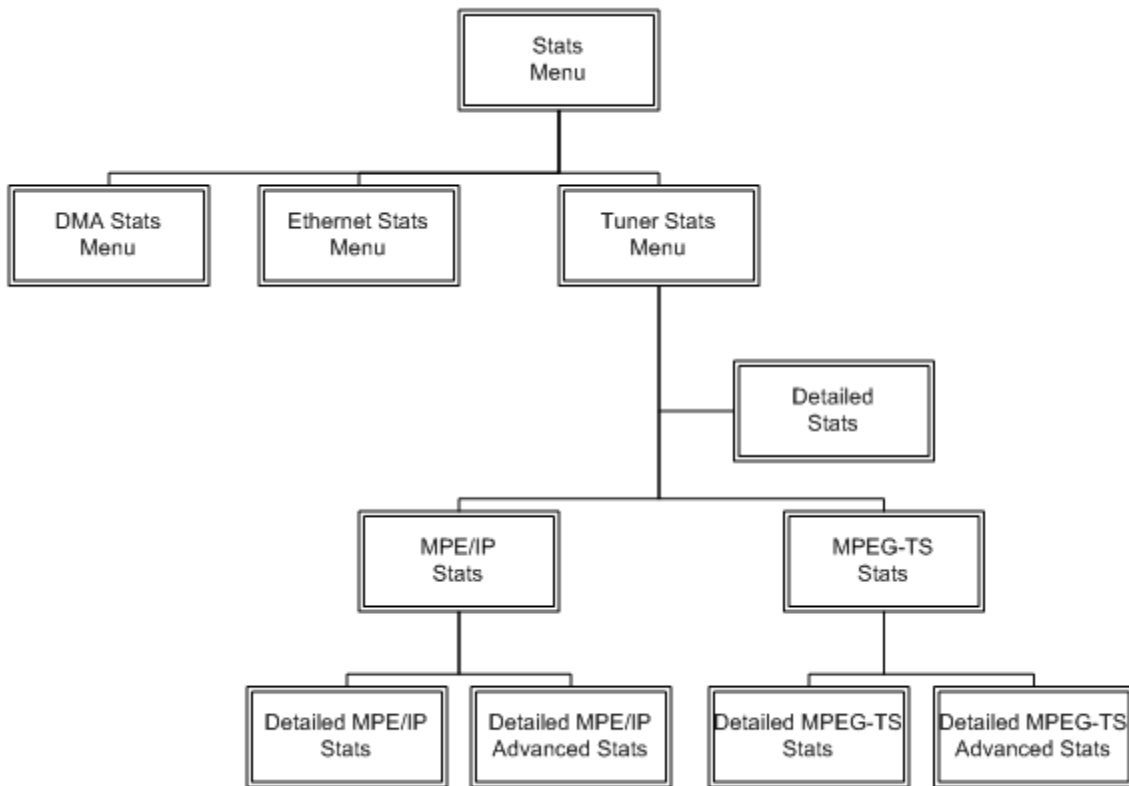

Figure 4-28. Stats Menu Hierarchy (via Terminal Interface)

4.3.6.1 DMA Stats Menu

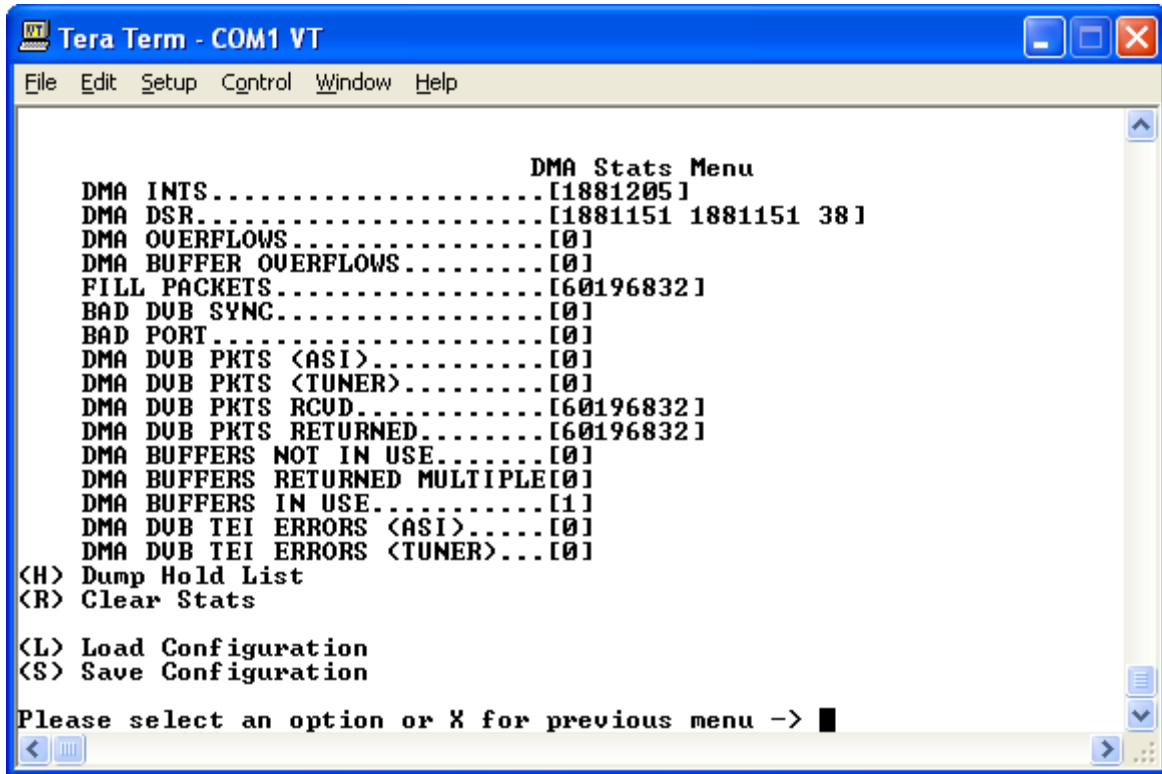

Figure 4-29. DMA Stats Menu

4.3.6.2 Ethernet Stats Menu

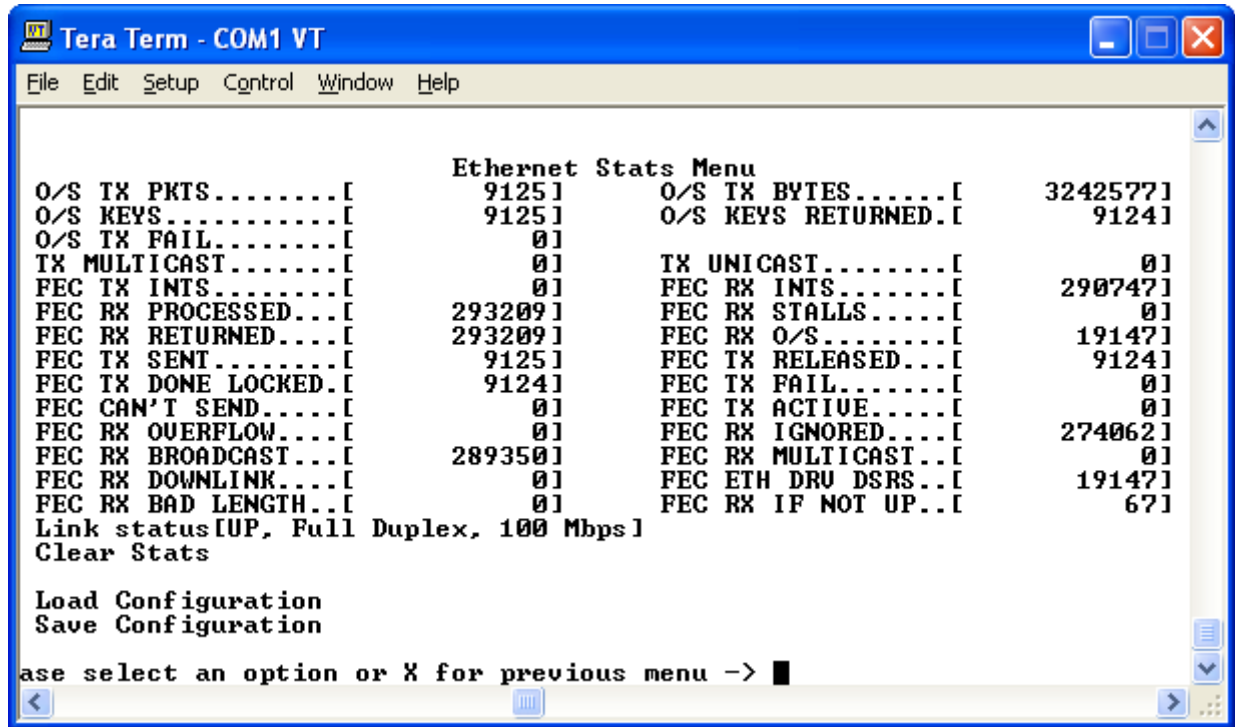

Figure 4-30. Ethernet Stats Menu

4.3.6.3 Tuner Stats Menu

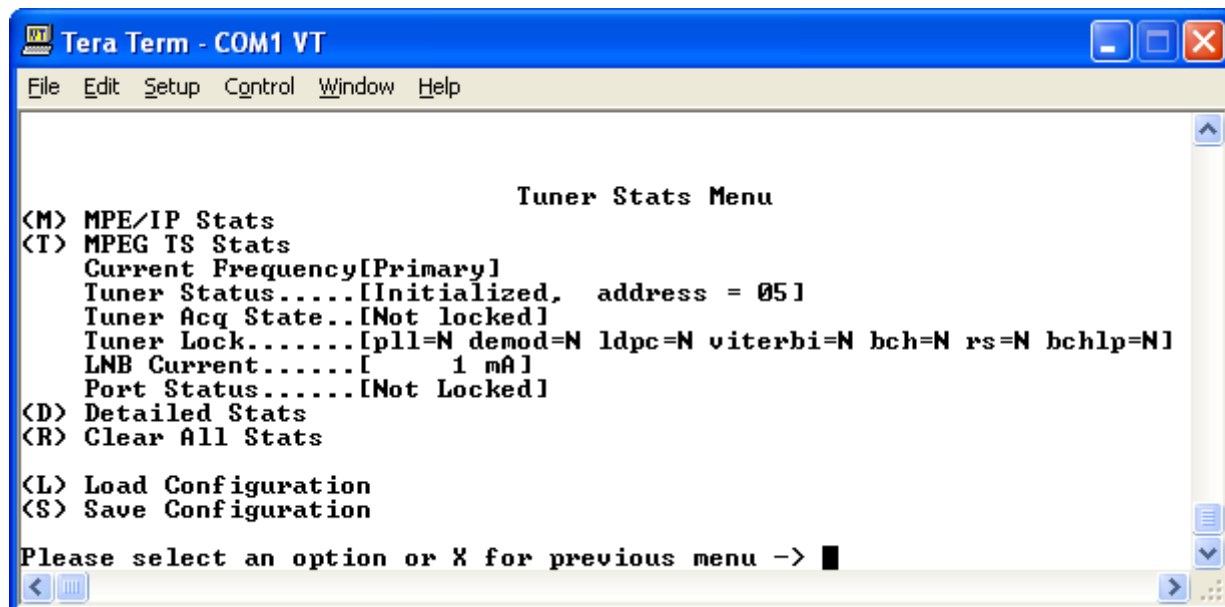

Figure 4-31. Tuner Stats Menu

Statistical reports are available from the MR-S2 using this menu.

The available report options are:

- MPE/IP
- MPEG TS
- Tuner

These detailed tuner statistics can be used to troubleshoot problems with a satellite link.

The available parameters are as follows:

Acquisition State

Displays whether the tuner is locked and tracking or whether the tuner is unlocked.

Lock Status

Displays the lock status of various components in the tuner:

- PLL – Phase Lock Loop
- Demodulator
- LDPC Decoder
- Viterbi Decoder
- BCH Decoder
- Reed Solomon Decoder
- BCHLP Decoder

4.3.6.3.1 Tuner MPE/IP Stats Menu

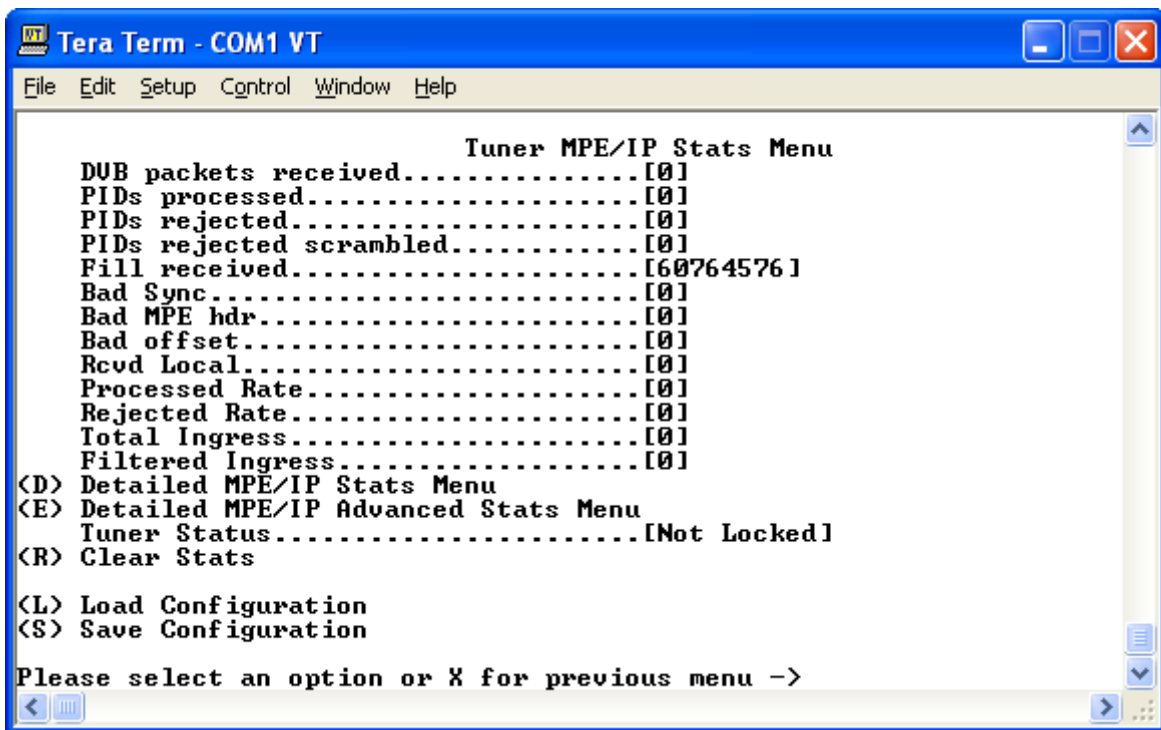

Figure 4-32. Tuner MPE/IP Stats Menu

4.3.6.3.1 Detailed Tuner MPE/IP Stats Menu

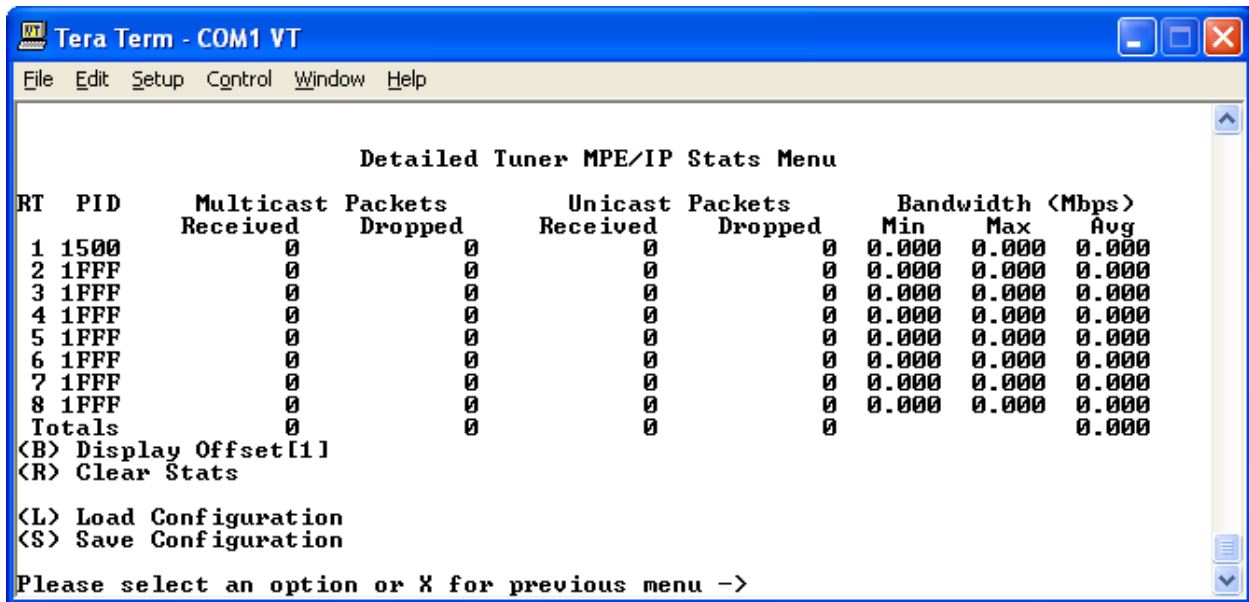

Figure 4-33. Detailed Tuner MPE/IP Stats Menu

4.3.6.3.1.2 Detailed Tuner MPE/IP Advanced Stats Menu

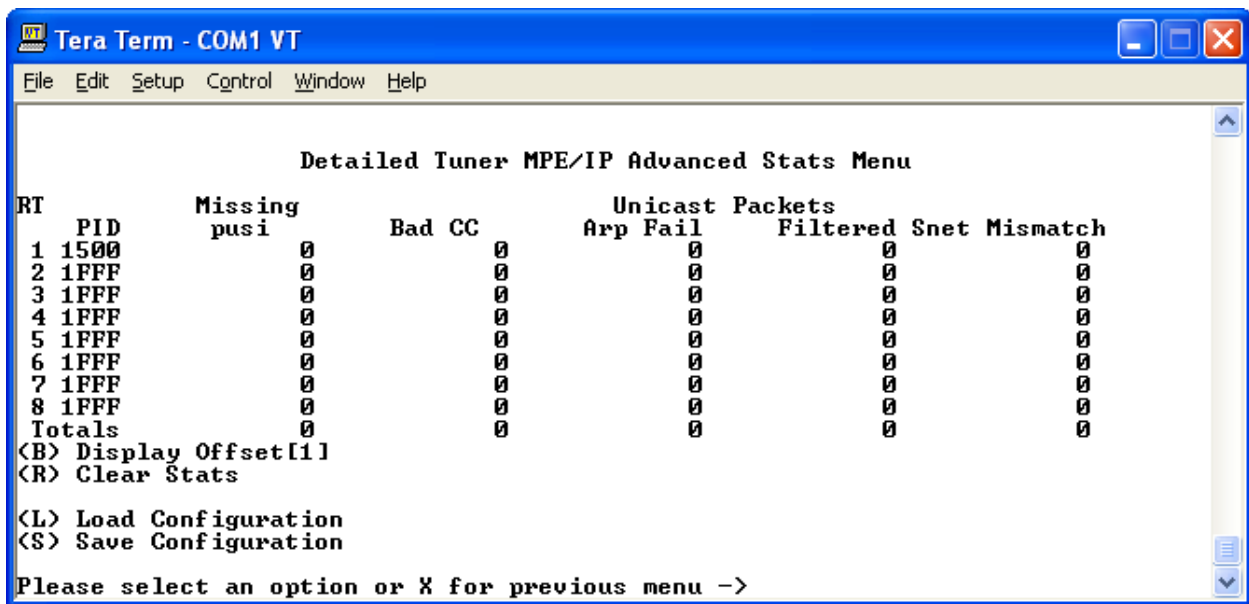

Figure 4-34. Detailed Tuner MPE/IP Advanced Stats Menu

4.3.6.3.2 Tuner MPEG TS Stats Menu

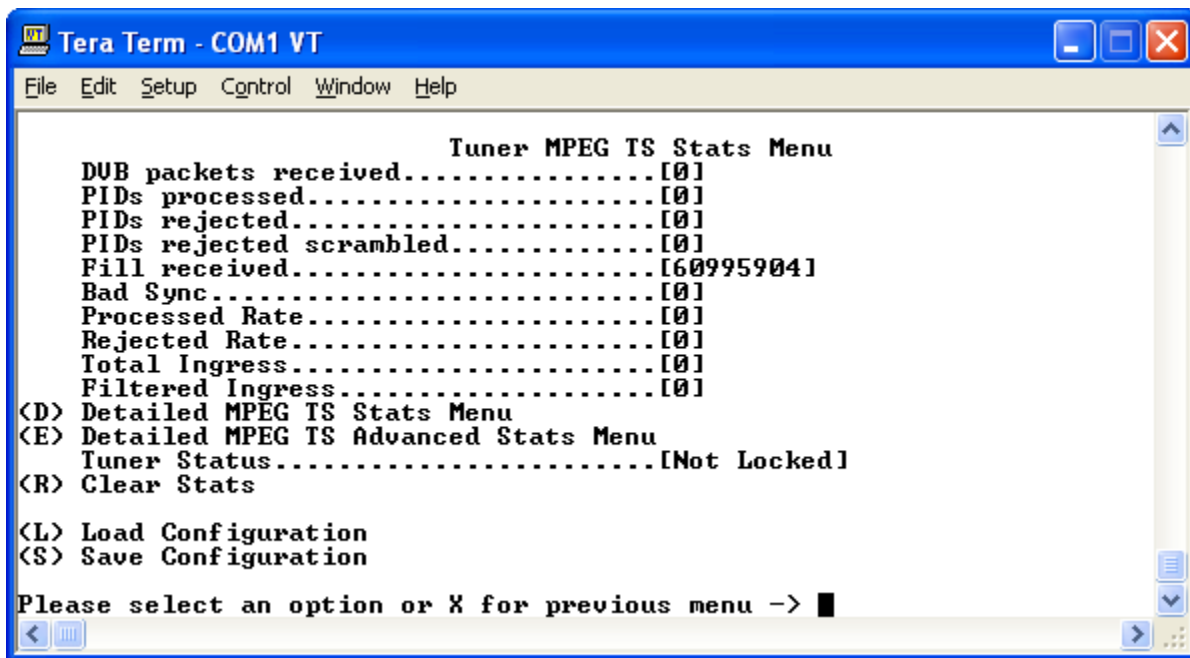

Figure 4-35. Tuner MPEG TS Stats Menu

4.3.6.3.2.1 Detailed Tuner MPEG TS Stats

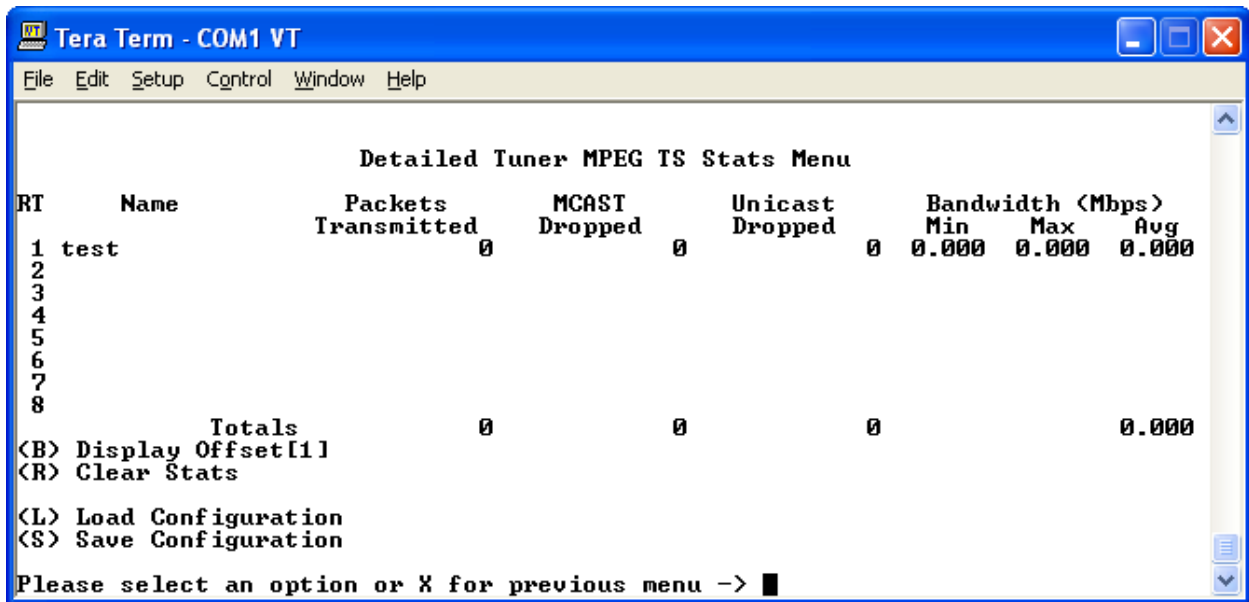

Figure 4-36. Detailed Tuner MPEG TS Stats

4.3.6.3.2.2 Detailed Tuner MPEG TS Advanced Stats Menu

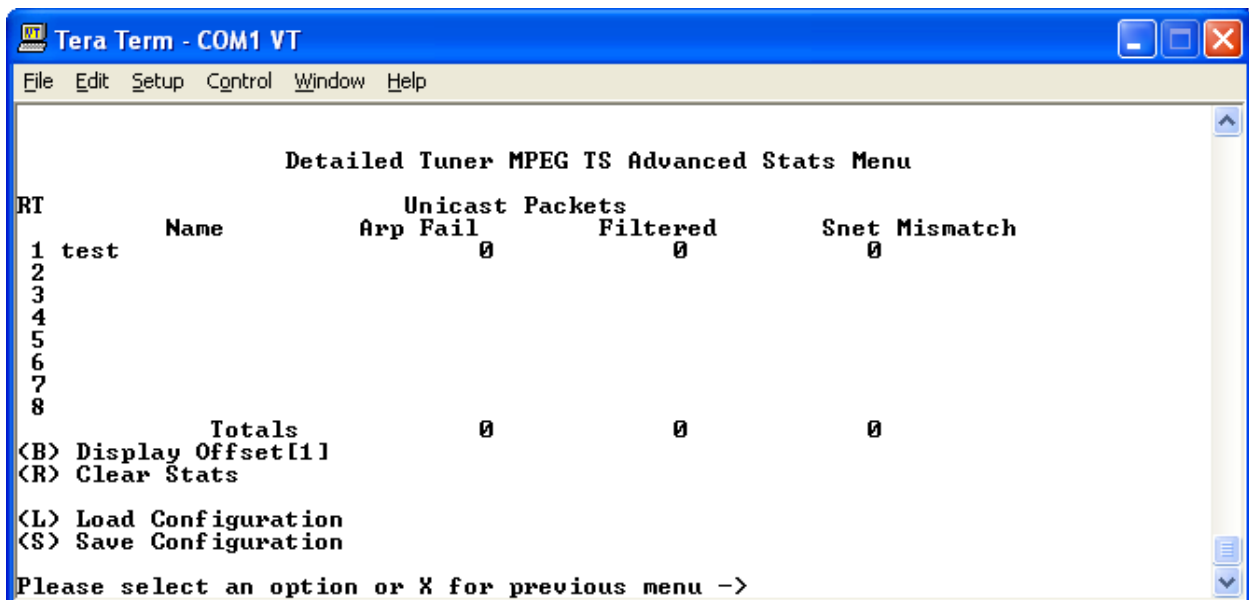

Figure 4-37. Detailed Tuner MPEG TS Advanced Stats Menu

4.3.6.3.3 Detailed Tuner Stats Menu

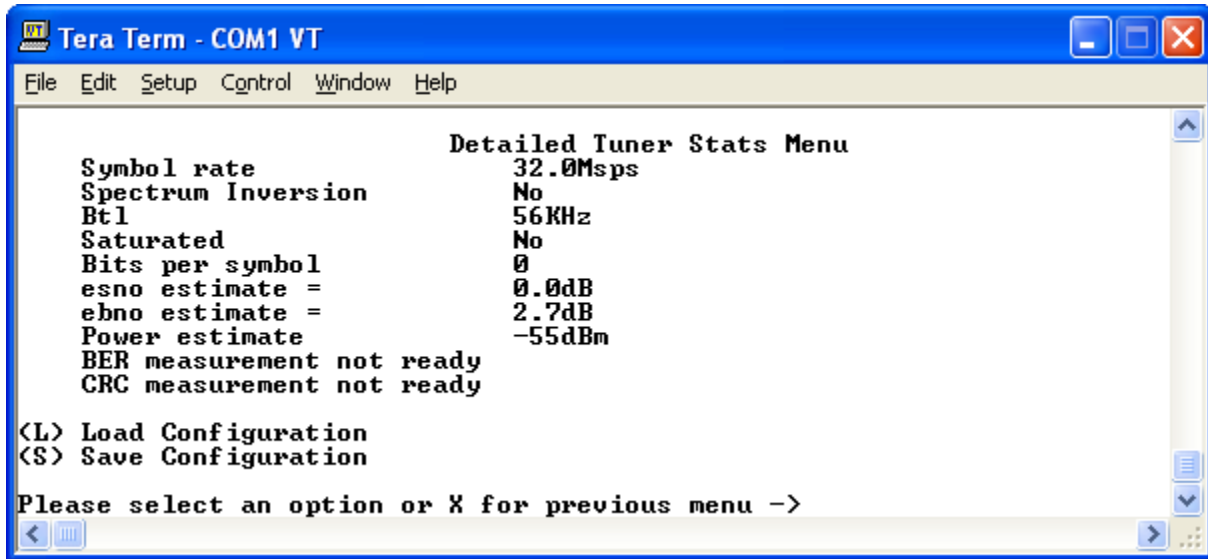

Figure 4-38. Detailed Tuner Stats Menu

4.3.7 Network Configuration Menu

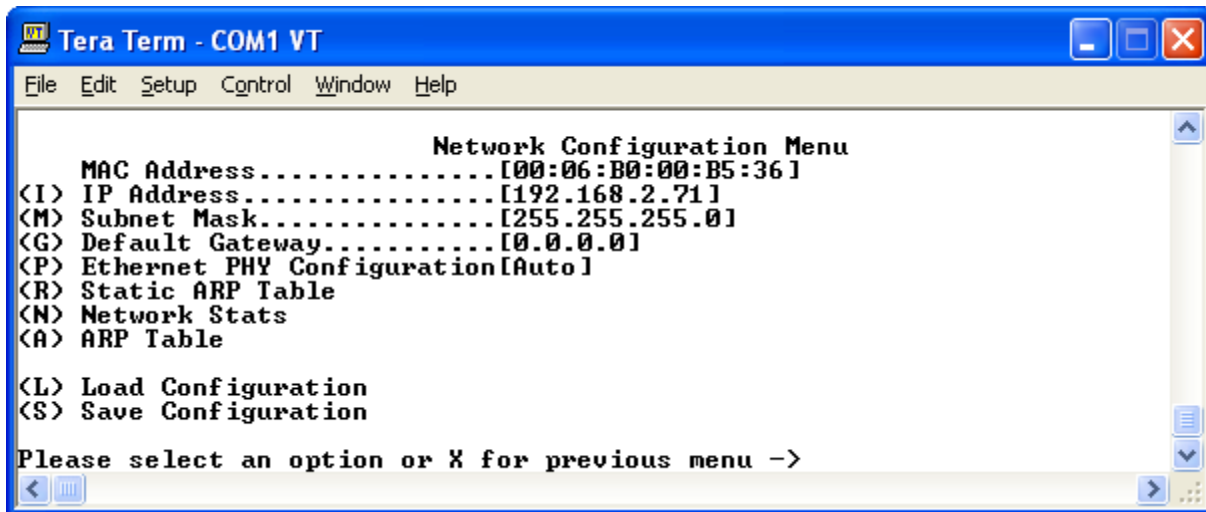

Figure 4-39. Network Configuration Menu

The Network Configuration page has the following configurable parameters:

IP Address

The IP Address assigned to the MR-S2's LAN interface. The IP Address is entered in dotted decimal format.

Subnet Mask

The Subnet Mask assigned to the MR-S2's LAN interface. The Subnet Mask is entered in dotted decimal format and is typically 255.255.255.0 for a C-Class mask, 255.255.0.0 for a B-Class mask or 255.0.0.0 for an A-Class mask.

Default Gateway

The Default Gateway assigned to the MR-S2's LAN interface. The Default Gateway is entered in dotted decimal format and must be within the subnet of the IP Address assigned to the LAN interface. The Default Gateway is the address of a local router to which all non-local subnet traffic will be directed.

4.3.8 Unicast Routing Configuration Menu

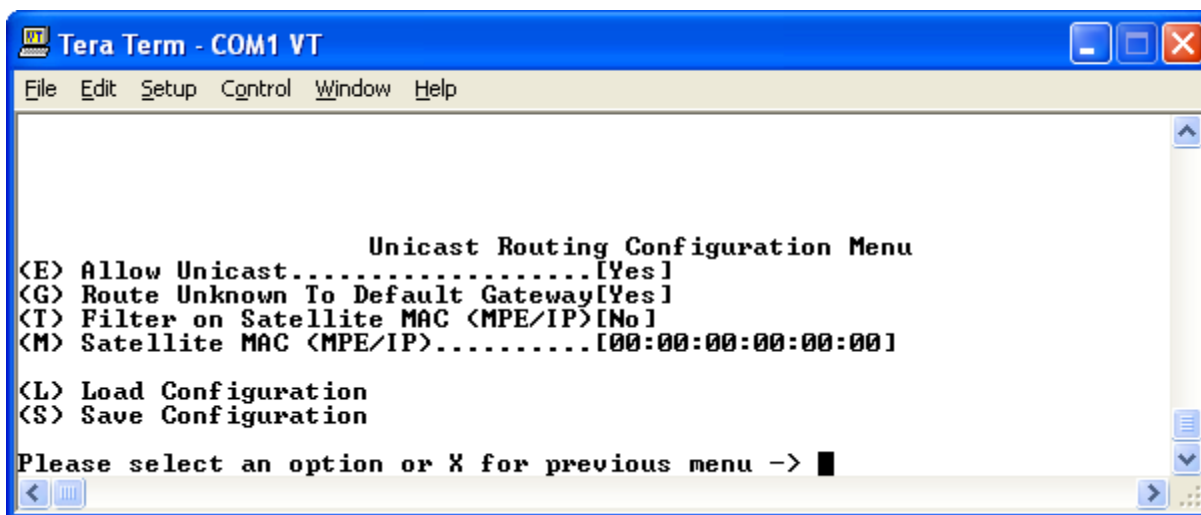

Figure 4-40. Unicast Routing Configuration Menu

The Unicast Routing Configuration page addresses the MR-S2's configuration for handling Unicast traffic over the transport stream. This feature is only used in the MPE/IP configuration.

Allow Unicast

Selects whether the MR-S2 will support the routing of Unicast traffic.

Route unknown to default gateway

If an Address Resolution Protocol (ARP) cannot be achieved, then incoming Unicast is directed to the configured default gateway.

Filter on TSD MAC (MPE/IP)

Allows the MR-S2 to route only Unicast that is specifically destined to this unit. The MAC address in the MPE header must exactly match the configured TSD MAC field.

Satellite MAC (MPE/IP)

The hardware Media Access Control (MAC) address assigned for Unicast operation.

4.3.9 Tuner Menu

This menu enables the user to configure the tuner for operation. The terminal configuration of the tuner is simple to perform and can be done at installation time.

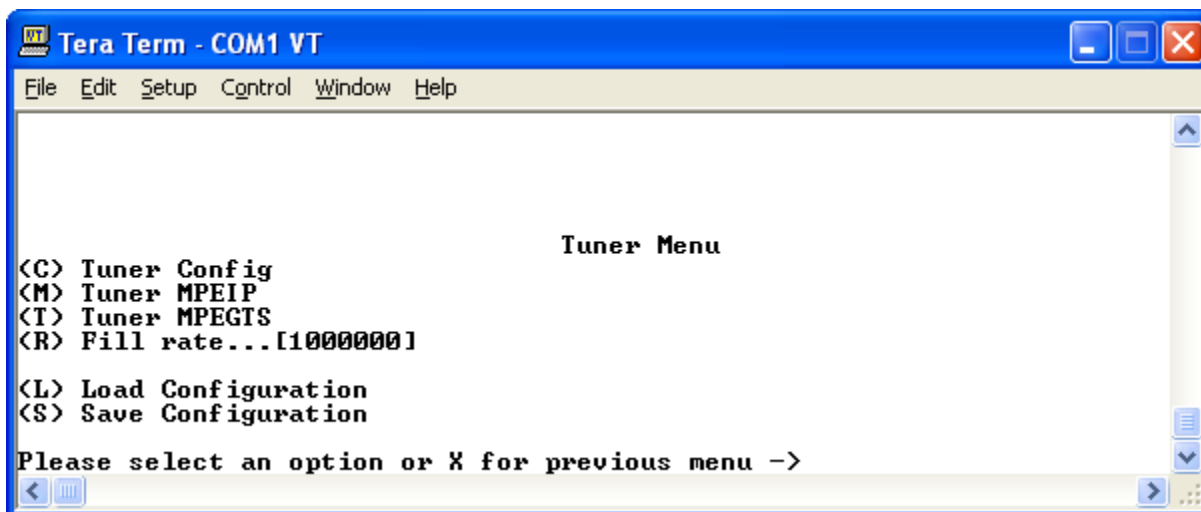

Figure 4-41. Tuner Menu

Menu items <C>, <M> and <T> are described in detail on the following pages.

Fill Rate

This value should **NOT** be changed from the factory default setting (1,000,000) unless the receiver is being used for low-latency traffic such as VoIP traffic.

Comtech EF Data recommends modifying this parameter to improve latency and jitter performance, to a setting greater than 5,000,000. The actual setting will depend upon traffic and may need to be set on a per case basis. The valid value range is 0 to 10,000,000, with the default as 1,000,000. VoIP traffic may require a setting between 5,000,000 to 10,000,000.

Setting the Fill Rate to 10,000,000 (the maximum setting) may lower the overall performance (packets per second and bits per second) of the product by as much as 10%, so care must be taken when modifying this parameter.

4.3.9.1 Tuner Configuration Menu

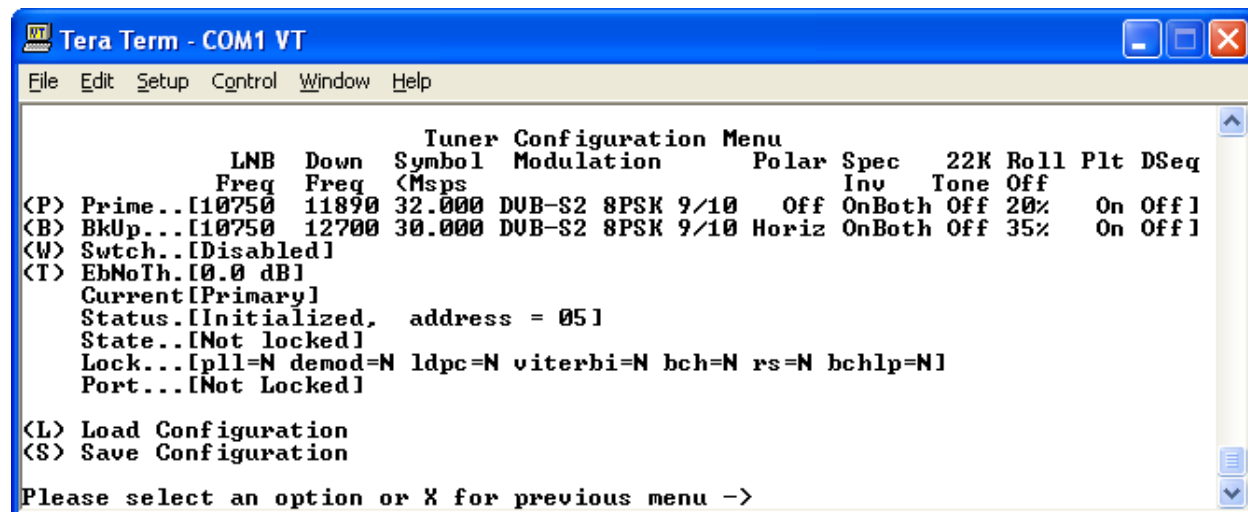

Figure 4-42. Tuner Configuration Menu

Primary and Backup Tuner Configuration

The MR-S2 can be configured to have a backup (secondary) configuration. The secondary tuner configuration allows the user to configure a backup configuration in the event the main carrier is taken down. The MR-S2 will only attempt to use the secondary configuration in the event the primary carrier is not available.

LNB Frequency

The frequency of the Local Oscillator (LO) that resides in the Low Noise Block (LNB) amplifier located at the antenna. For Ku-Band operation, the LO is typically 10,750 MHz for Ku-Band operation North America and other common frequencies are 9,750 MHz and 10,600 MHz. For C-Band operation, 5,150 MHz is a common LO frequency. Please consult your LNB manufacturer for the LO in the LNB.

Downlink Frequency

The actual receive frequency being down linked from the satellite to the Low Noise Block (LNB) amplifier located at the antenna. For Ku-Band operation, this frequency ranges from 10,700 MHz to 12,750 MHz. For C-Band operation, this frequency ranges from 3,400 MHz to 4,200 MHz.

The combination of the LO and the downlink frequency produce the L-Band frequency expected by the MR-S2. Some examples are as follows:

Example 1:

LO = 10,750 MHz
 Ku-Band Receive Frequency = 11,895 MHz
 L-Band Frequency = 11,895 MHz – 10,750 MHz
 L-Band Frequency = 1,145 MHz

Example 2:

LO = 10,600 MHz

Ku-Band Receive Frequency = 12,010 MHz

L-Band Frequency = 12,010 MHz – 10,600 MHz

L-Band Frequency = 1,410 MHz

Example 3:

LO = 5,150 MHz

C-Band Receive Frequency = 3,920 MHz

L-Band Frequency = 5,150 MHz – 3,920 MHz

L-Band Frequency = 1,230 MHz

Modulation

The MR-S2 supports the following modes of operation:

- DVB-S – QPSK
- DVB-S2 – QPSK
- DVB-S2 – 8PSK

Each mode of operation provides a range of FEC rates that are supported based on the mode and modulation.

Symbol Rate

Depending on the configured mode of operation, the following symbol rates are supported:

- DVB-S – QPSK 2 to 45 Msps
- DVB-S2 – QPSK 2 to 32 Msps
- DVB-S2 – 8PSK 2 to 32 Msps

Polarity

The configured polarity provides the voltage supplied to the LNB or switch. The valid selections for the MR-S2 are 13 VDC for vertical polarization and 18 VDC for horizontal polarization. The MR-S2 is capable of providing up to 500mA of current in either mode of operation. It is recommended, that if the LNB voltage is not required, that a DC block be installed.

Spectral Inversion

There are four supported modes of spectral inversion:

- **On** – forces the tuner to stay with spectral inversion. The tuner will not check for spectral inversion automatically
- **Off** – forces the tuner to stay without spectral inversion. The tuner will not check for spectral inversion automatically
- **On Both** – tries spectral inversion first and then attempts to automatically check spectral inversion periodically
- **Off Both** – tries non-spectral inversion first and then attempts to automatically check spectral inversion periodically

LNB 22 KHz Tone

Enables or disables the LNB 22 KHz tone to the LNB for remote LNB and switch control.

Pilot

Enables or disables the Pilot for DVB-S2 mode of operation only.

Roll Off

The expected filter roll off of the carrier the receiver should be looking at. This parameter only works for DVB-S2 mode, since DVB-S mode uses a fixed roll off of 35%.

The valid roll offs in DVB-S2 modes are:

- 20%
- 25%
- 35%

DiSEqC

Enables sending and receiving DiSEqC commands as are supported in DiSEqC mode 1.2. The valid configuration settings for DiSEqC mode are:

- Off
- Mode A
- Mode B
- Mode C
- Mode D

Switch

Enables or disables the ability to switch to a backup carrier. If set to disabled, the MR-S2 will not attempt to switch to a backup carrier.

Switch Time

The number of seconds the unit should wait before attempting to locate the backup carrier. Setting the switch time to a setting of 0 (zero) causes the backup frequency to be disabled.

4.3.9.2 Tuner MPE/IP Configuration Menu

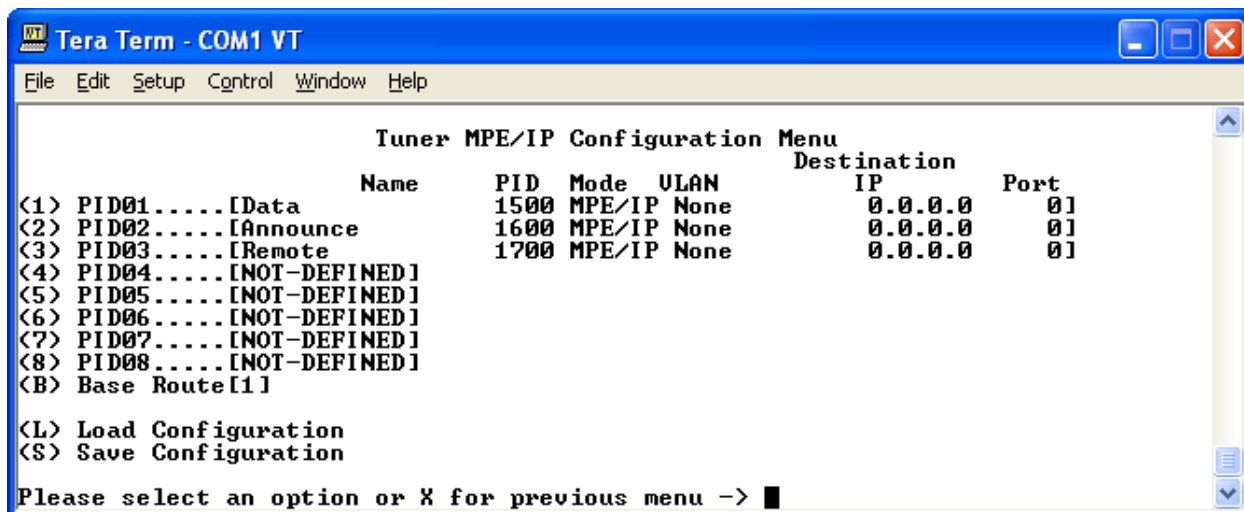

Figure 4-43. Tuner MPE/IP Configuration Menu

A configured PID value in hexadecimal is required for MPE/IP data to be extracted from the transport stream and sent to the CPU. Once a valid PID value is configured, and data is found on a transport stream, the data is decapsulated and delivered to the Ethernet port. A value of 0x1FFF is disabled.

Name

The name of the route.

PID

The PID value in hexadecimal format.

Mode

MPE/IP or DVB-TS.

VLAN

Options are None, All, or 1 to 4094.

Destination IP

A valid destination IP address if mode is DVB-TS.

Port

A valid port if mode is DVB-TS.

4.3.9.3 Tuner MPEG TS Configuration Menu

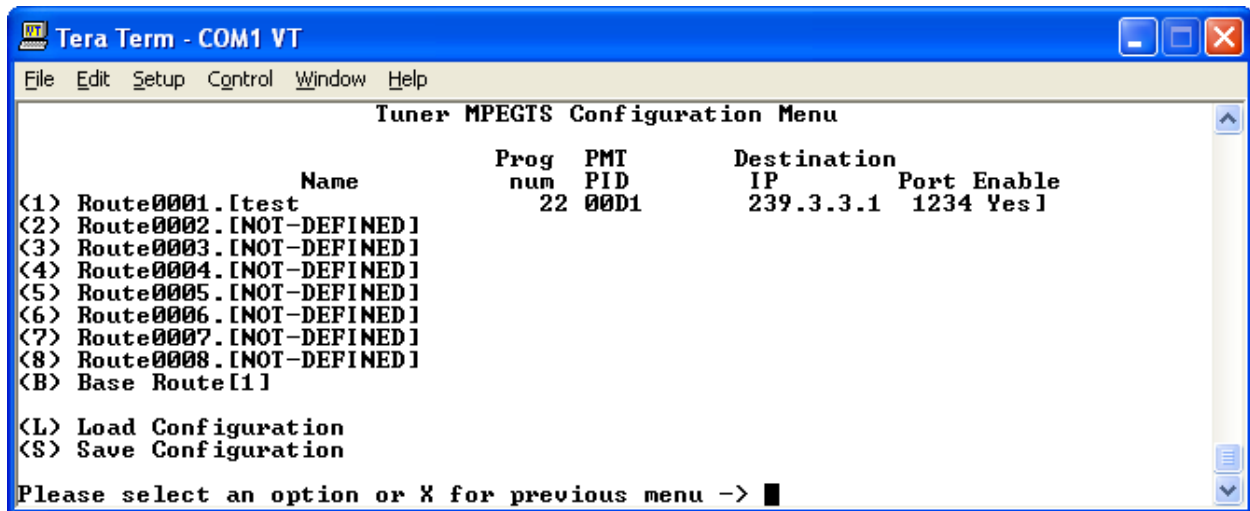

Figure 4-44. Tuner MPEG TS Configuration Menu

Name

The name of the incoming program that is extracted from the Program Service Information.

Program Number

The program number to be routed to the Ethernet as Transport Stream over IP.

PMT PID Number

The PMT PID to be routed to the Ethernet as Transport Stream over IP.

Destination IP

The IP address to be used when routing the Transport Stream over Ethernet IP.



Port Number

The Port Number to be used when routing the Transport Stream over Ethernet IP.

Enable

Enables or disables the route.

4.4 Telnet Interface

Telnet provides a textual interface over a LAN. Most PCs have the capability to use Telnet. To use Telnet on a Microsoft Windows® product, click , then .

The Run dialog box is shown in Figure 4-45. In the **Open:** text window, enter “**telnet xxx.xxx.xxx.xxx**,” where **xxx.xxx.xxx.xxx** is the IP address of the MR-S2. If the port number has been modified from the **standard 23** via the Terminal Interface, then the port number must be appended with a colon to the IP address.

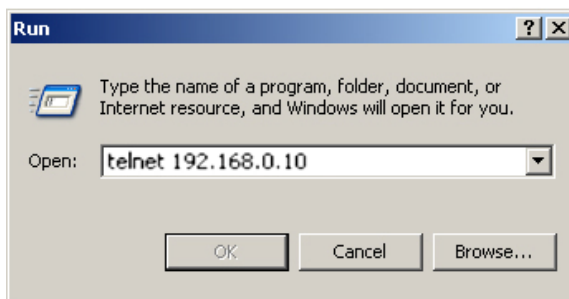

Figure 4-45. Starting Telnet Session

The user will be prompted to enter the user name and password to gain access to the telnet interface.



The default username is “comtech” and the default password is “comtech”, both of which are case sensitive.

Once the menu is started, press **<ENTER>** and the MR-S2 Main Menu will display as shown in 4-46. Main Menu . The user may navigate the menus in the same manner as the Terminal Interface. With specific exceptions as noted in the Terminal Interface section, the menus available via Telnet and Serial interfaces are identical.



```
Telnet 192.168.141.200

Main Menu
Digicast MediaRouter S2 2.4.1   Nov 28 2007 14:12:23
Copyright Comtech EF Data

<Y> Redundancy Menu
<A> Administration Menu
<I> IGMP Menu
<C> Stats Menu
<N> Network Menu
<U> Unicast Routing Menu
<T> Tuner Menu

<L> Load Configuration
<S> Save Configuration

Type ctrl-d to terminate telnet session.
Please select an option -> _
```

Figure 4-46. Main Menu via Telnet

4.5 Trivial File Transfer Protocol (TFTP)

The MR-S2 supports changes to the resident software and firmware by means of the Trivial File Transfer Protocol (TFTP). This enables changes to be made remotely via the LAN interface. It is recommended to use Solarwinds TFTP server application (available at <http://support.solarwinds.net/updates/SelectProgramFree.cfm>).

To modify the software and/or firmware, use the following procedures:

Configure the server as follows:

- a) **File** → **Configuration** → Select the **'TFTP Root Directory'**. Set up the location of the MR-S2 files.
- b) **File** → **Configuration** → Select the **'Security'** tab and make sure **'Transmit and Receive'** are selected.
- c) Save configuration.

The server is now configured for the file transfer process.



Because the MR-S2 stops processing data traffic during the download process, it is recommended that this upgrade procedure be performed during scheduled network down time.

Do NOT remove power from the unit during the download process.

To modify code via Telnet:

Step	Procedure
1	Start up Solarwinds TFTP server – Ensure configuration as described previously.
2	Ensure that the code provided by CEFD is located in the TFTP Root directory.
3	Start up Telnet client and initiate a session with the MR-S2 as described in the Telnet Interface section
4	Select 'A' for Administration
5	Select 'D' for Download
6	Enter '1' for Application code or '2' for FPGA code (the user will be directed to select Application or FPGA code in the download instructions provided by CEFD when new code is provided)
7	Enter the IP address of the TFTP server and wait for the message "Upgrade complete. Press any key to continue"

This code modification process can also be conducted via the Web Interface, under the Administration page, or the Terminal Interface under the Main Menu.



Under heavy traffic conditions, the TFTP transfer may take several minutes. The transfer process reported by Solarwinds may show greater than 100% transferred, but this is a normal condition. Be patient and allow the transfer to take place.

4.6 Simple Network Management Protocol (SNMP)

Simple Network Management Protocol (SNMP) allows an SNMP Manager such as OpenView or Castle Rock to be used to remotely manage the MR-S2 in an automated fashion.

The MR-S2 supports SNMP versions 1 and 2 (SNMPv1 and SNMPv2). Two types of Management Information Bases (MIBs) are supported: **MIB II** and **private MIB**.

MIB II is the default MIB that is used to gather generic information about the unit, such as system 'up' time, packets sent or received on an interface, etc. **MIB II** is designed for only read access, not write access. To read and write configuration parameters over SNMP requires a **private MIB**. The **private MIB** allows parameters to be set on the Web, Terminal, or Telnet interfaces.

The elements Object Identifiers (OIDs) of the MIB will be listed in the appendix of a revised version of this manual. CEFD has been assigned an SNMP designator by the IEEE, which will be found in all elements of the MR-S2's MIB.



NOTE

The assigned designator for CEFD (enterprise OID) is 1.3.6.4.1.18723.

The MR-S2 supports configurable community strings for added security. **As a security precaution, passwords cannot be remotely queried over SNMP.**

For SNMP access from a remote network via the public Internet, a VPN connection to the MR-S2 will need to be established using third-party VPN client/server access.

The default community strings for the SNMP R/W community is "*private*" and the R/O community is "*public*".

4.6.1 SNMP Traps

The CMR-5975 supports SNMP Traps for providing unsolicited SNMP events to a pre-configured SNMP Manager. The SNMP Trap may be used as a tool to automatically notify an SNMP manager of a change that has taken place on the unit. Traps typically define a state change such as an interface that goes from active to inactive (or up to down). SNMP Traps provide unsolicited reporting to a central SNMP manager, so events can be reported as they happen.

The Traps supported on the CMR-5975 are as follows:

Generic Traps (SNMPv1)

- **Cold Start** - Unit has booted from a cold start (hardware startup)
- **Warm Start** - Unit has re-booted from a power on start (warm startup)
- **Link Down** - An interface has gone from up to down (such as a tuner has lost lock)
- **Link Up** - An interface has gone from down to up (such as a tuner regaining lock)
- **Authentication Failure** - An SNMP message received could not be authenticated

Specific Traps (SNMPv1)

- **dniEbNoThresholdOK** - EbNo value is now set above the defined limit
- **dniEbNoThresholdFail** - EbNo value has fallen below the defined limit
- **dniRedundancyBackup** - Redundant backup unit is now active
- **dniRedundancyPrimary** - Redundant primary unit is now active
- **dniRedundancyModeConflict** - A conflict in redundancy mode has been detected
- **dniMPEGPIDConflict** - MPEG-TS PID Conflict has occurred
- **dniDMAOverflow** - DMA Overflow
- **dniDMAOverflowCleared** - DMA Overflow Cleared

Appendix A. SOFTWARE UPGRADE

A.1 Introduction

The MR-S2 is enabled to receive an upgrade via Trivial File Transfer Protocol (TFTP) transmission. Comtech EF Data recommends using the Solarwinds TFTP server application (available at <http://support.solarwinds.net/updates/SelectProgramFree.cfm>) for upgrading the product.



The user will be instructed whether to select Application or FPGA or Redboot code in the download instructions provided by CEFD when new code is provided.

Once the TFTP server is enabled and the new file (**Application** or **FPGA** or **Redboot**) has been copied to the TFTP server, the procedures outlined in sections A.2 and A.3 may be used to upgrade the unit.

A.2 Web Interface

Access the **Administrative Configuration** menu (Figure A-1):

- a) In the **Update Firmware** section, enter the **Unit TFTP Server IP Address**.
- b) Select **Application** or **FPGA** for the **Image Type** to be upgraded.
- c) Enter a valid username and password in the **Login Required** section (below the **Update Firmware** section) then select **Update**. The software update will begin to download.



IMPORTANT

Do NOT power the unit down during the upgrade process.

- d) When the update is complete, the message “**Press any key to continue**” will be displayed.
- e) Once the unit is upgraded, reset the unit by entering a valid username and password in the first **Login Required** section, then selecting **Reset Unit**.

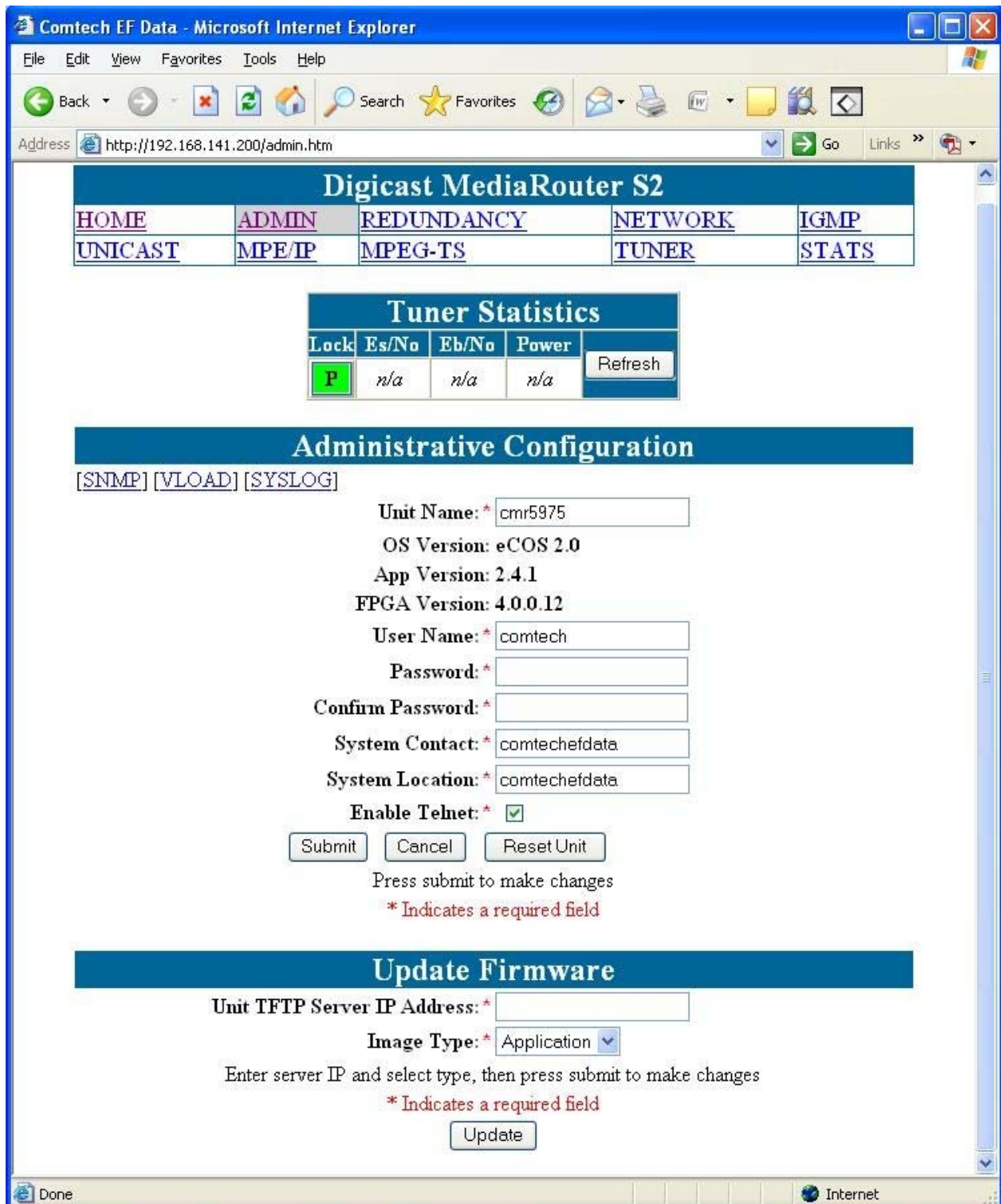

Figure A-1. TFTP Download (via Web)

A.3 Telnet or Terminal Interface

Access the Admin Menu (Figure A-2):

- a) Select **(D)** for **Download Image**.
- b) At the “**Image type**” prompt, enter: **1** for **Application** or **2** for **FPGA** or **3** for **Redboot**.
- c) Enter the TFTP IP server address. Once the TFTP IP server address is entered, the software update will begin to download.



IMPORTANT

Do NOT power the unit down during the upgrade process.

- d) When the update is complete, the message “**Press any key to continue**” will be displayed (Figure A-3).
- e) After the unit has been upgraded, reset the unit by selecting **(R)** for Reset and ‘**Y**’ to confirm the reset.

```
Tera Term - COM1 VT
File Edit Setup Control Window Help

Administration Menu
(N) Unit Name.....[cmr5975]
  OS Version.....[eCOS 2.0]
  App Version.....[2.4.1 ]
  FPGA Version.....[4.0.0.12]
(U) Username.....[comtech]
(P) Password.....[*****]
(C) System Contact.....[comtechefdata]
(Y) System Location.....[comtechefdata]
(I) SNMP server IP address.....[0.0.0.0]
(W) SNMP R/W Community.....[*****]
(O) SNMP R/O Community.....[*****]
(T) Enable Telnet.....[Yes]
(U) Uload Configuration Menu
(F) Display Config
(D) Download Image
(M) Auto Logout and Port Configuration Menu
(G) Syslog Configuration Menu
(R) Reset Unit
(A) Load Factory Defaults

(L) Load Configuration
(S) Save Configuration

Please select an option or X for previous menu -> █
```

Figure A-2. TFTP Download (via Terminal)

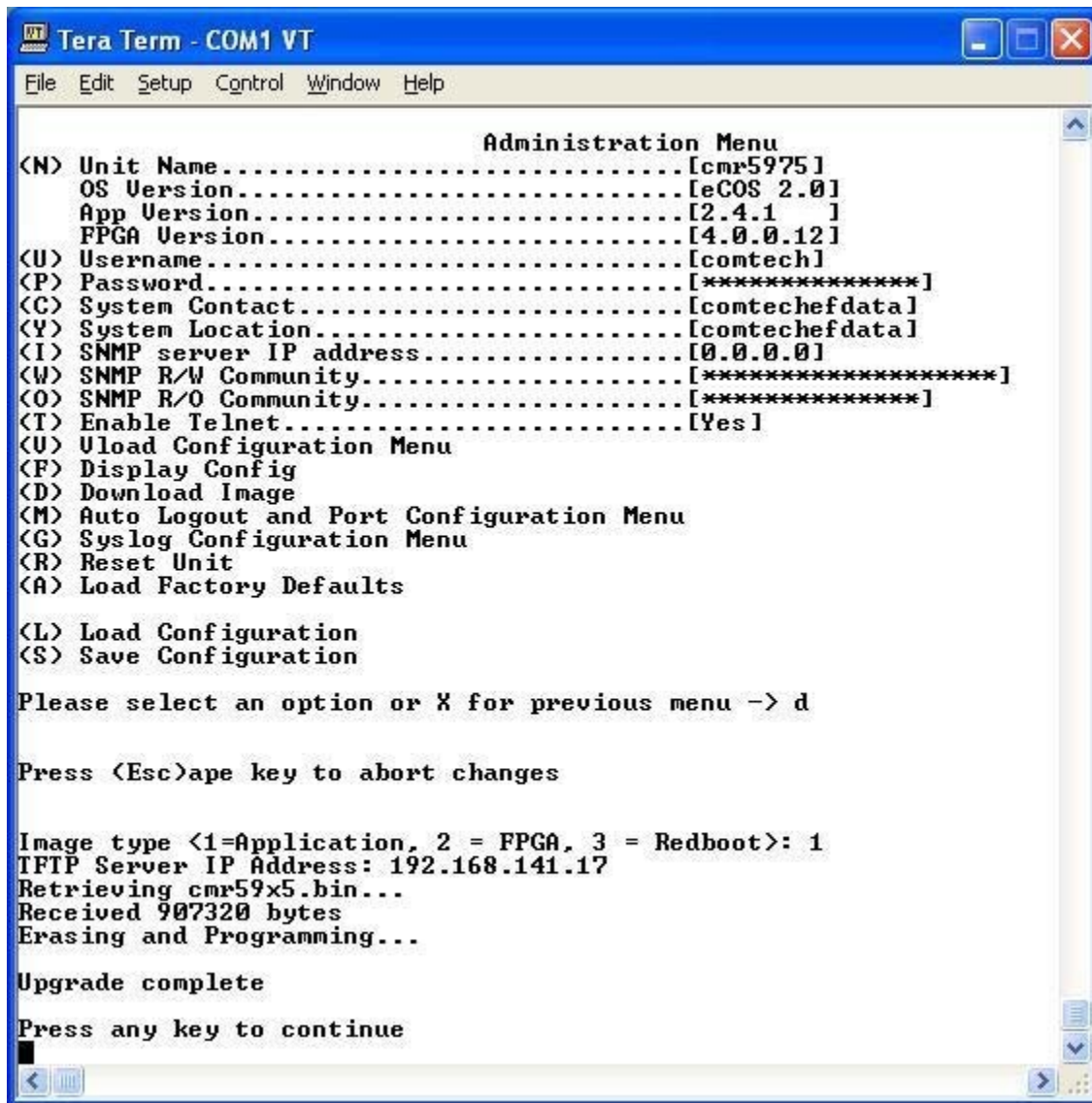

```
Tera Term - COM1 VT
File Edit Setup Control Window Help

                                Administration Menu
<N> Unit Name.....[cmr5975]
    OS Version.....[eCOS 2.0]
    App Version.....[2.4.1 ]
    FPGA Version.....[4.0.0.12]
<U> Username.....[comtech]
<P> Password.....[*****]
<C> System Contact.....[comtechefdata]
<Y> System Location.....[comtechefdata]
<I> SNMP server IP address.....[0.0.0.0]
<W> SNMP R/W Community.....[*****]
<O> SNMP R/O Community.....[*****]
<T> Enable Telnet.....[Yes]
<U> Uload Configuration Menu
<F> Display Config
<D> Download Image
<M> Auto Logout and Port Configuration Menu
<G> Syslog Configuration Menu
<R> Reset Unit
<A> Load Factory Defaults

<L> Load Configuration
<S> Save Configuration

Please select an option or X for previous menu -> d

Press <Esc>ape key to abort changes

Image type <1=Application, 2 = FPGA, 3 = Redboot>: 1
TFTP Server IP Address: 192.168.141.17
Retrieving cmr59x5.bin...
Received 907320 bytes
Erasing and Programming...

Upgrade complete
Press any key to continue
```

Figure A-3. TFTP Download Complete (via Terminal)

Notes:

Appendix B. IP ROUTING SUPPORT

B.1 Introduction

The MR-S2 provides state-of-the-art L-Band DVB-S and DVB-S2 IP and transport stream delivery based on the ISO/IEC 13818-1, ISO/IEC 13818-6 and DVB Specification for Data Broadcasting (EN 301 192).

The MR-S2 provides the following configuration features:

- Support for DVB-S reception at rates from 2 to 45 Msps
- Support for DVB-S2 reception at rates:
 - QPSK 2 to 32 Msps
 - 8PSK 2 to 32 Msps
- IP Decapsulation per Multi-Protocol Encapsulation (EN 301 192)
- Unicast Routing
- Multicast Routing
- Section Packing and Non-Section Packing
- IGMP version 2

B.2 IP Configuration

Both Unicast and Multicast IP datagrams are encapsulated per the Multiprotocol Encapsulation MPE specification. Routing of datagrams is accomplished by configuration of PIDs in the MR-S2, as described in the following sections.

B.2.1 Unicast Routing

Unicast routing provides point-to-point delivery of IP datagrams. Routes for Unicast IP packets are configured according to the following:

- IP Addresses, which fall into three classes:
 - A (0.0.0.0 to 127.255.255.255)
 - B (128.0.0.0 to 191.255.255.255)
 - C (192.0.0.0 to 223.255.255.255)
- Medium Access Control (MAC) Addresses, which identifies the destination device (next-hop) to which the packets are sent. The least-significant bit of the first byte of the six-byte MAC address is a '0'. For example, 0x00 11 22 33 44 55 is a Unicast address.

Unicast is supported by the MR-S2 as it would be in any routed network. Packets received by the MR-S2 are routed to the Ethernet if they meet the subnet criteria or the MR-S2 is configured to route non-local packets to a default gateway.

The MR-S2 uses Classless Inter-Domain Routing (CIDR) notation in which a 'slash' followed by a decimal number is used to represent the number of bits for the mask, e.g. /32 is 255.255.255.255 and /24 is 255.255.255.0.

As stated above, part of the route configuration is a MAC address that is assigned for delivery of the packet when it is encapsulated into MPE. The MAC address typically identifies the remote receiver (physical device), e.g. satellite terminal, DTV terminal, or cable receiver.

B.2.2 Multicast Routing

Multicast routing provides point-to-multipoint delivery of IP datagrams. Routes for multicast IP packets are configured according to the following:

- IP Addresses, which fall into class D (224.0.0.0 to 239.255.255.255)
- Medium Access Control (MAC) Addresses, which identifies the frames as multicast. The least-significant bit of the first byte of the six-byte MAC address is a '1'. For example, 0x01 00 5E 00 00 01 is a multicast address
- Broadcast frames are identified by the MAC Address **0x FF FF FF FF FF FF**.

Multicast IP addresses are related to multicast MAC addresses as follows:

The lower 23 bits of the IP address are mapped into the lower 23 bits of the MAC address as shown in Figure B-1. Examples of the relationship are:

- 1) Received IP: 239.1.1.10 = MAC: 0x01 00 5E 01 01 0A
- 2) Received IP: 224.10.10.10 = MAC: 0x01 00 5E 0A 0A 0A
- 3) Received IP: 228.63.10.10 = MAC: 0x01 00 5E 3F 0A 0A

Note that the upper 5 bits of the multicast IP address are ignored in the MAC so that 32 Multicast group IP addresses map to a single MAC address. This implies further filtering is required at the end device.

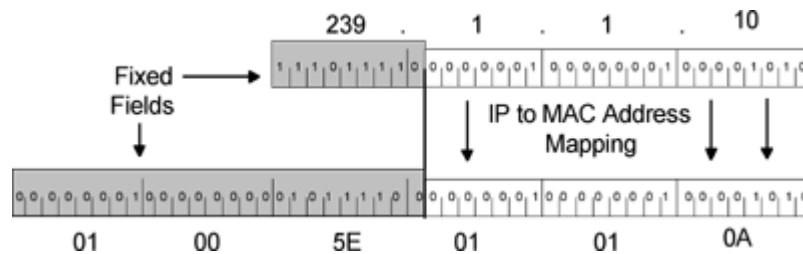

Figure B-1. Multicast Mapping (IP to MAC)

B.3 Section Packing

Section packing is a technique utilized to provide more optimal utilization of the MPEG-2 transport stream (TS) packet structure. When section packing is not used, each TS packet (containing the MPE section) can carry no more than a single section. This often results in wasted payload capacity when the sections are less than 184 bytes.

The section packing feature allows more than a single MPE section to be carried by an MPEG-2 TS packet, thereby minimizing wasted payload capacity.

In the case of a large MPE section that spans multiple MPEG-2 packets, the ending of an MPE section may occur in the middle of an MPEG-2 packet. In this instance, with section packing, a new MPE section begins immediately after the first MPE section has finished without any 'fill' (wasted) bytes having to be inserted before the start of the next MPEG-2 packet.

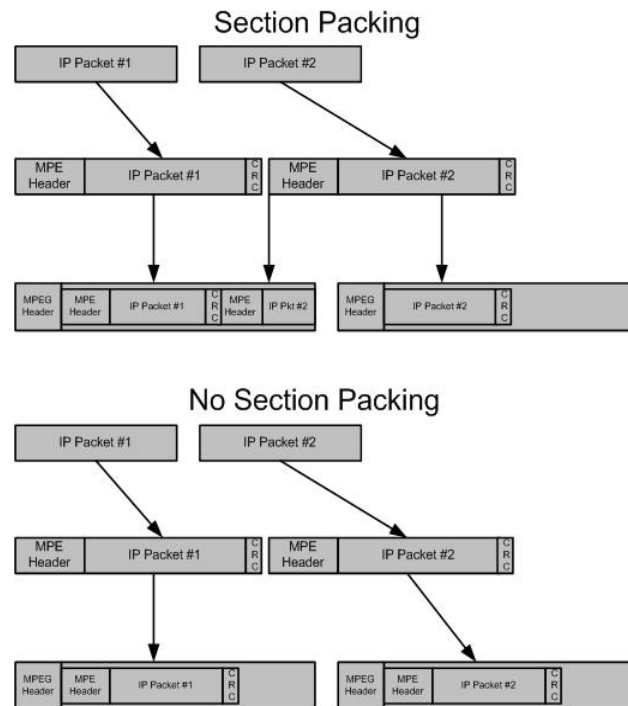

Figure B-2. Section Packing

Appendix C. SYSTEM LOG CONFIGURATION

C.1 Introduction

The MR-S2 supports a feature known as **system logging**, more commonly called **Syslog**.

This section illustrates how a **system logger** can be set up on a Linux or Unix system¹, allowing the MR-S2 to report system events to a logger attached via an Ethernet connection.

C.2 Enabling a System Logger

To enable system logging, add the following command string to the bottom of the `/etc/syslog.conf` file on the Logging Server:

```
=====
# log the mux messages to here
*.=info /var/log/mux.log
=====
```

Where:

*.**.=info** tells the logger to send all messages it receives from the Mux to the Dir/file

¹ Note that this is merely a sample configuration. CEFD does not support the setup of a syslog server, since it is assumed that one is already configured and operational for use.

Looking in the top of file `/etc/init.d/syslog2`, the following is usually displayed:

```
#!/bin/bash
#
# syslog    Starts syslogd/klogd.
#
#
# chkconfig: 2345 12 88
# description: Syslog is the facility by which many daemons use to log \
# messages to various system log files. It is a good idea to always \
# run syslog.

# Source function library.
. /etc/init.d/functions

[ -f /sbin/syslogd ] || exit 0
[ -f /sbin/klogd ] || exit 0

# Source config
if [ -f /etc/sysconfig/syslog ] ; then
    . /etc/sysconfig/syslog
else
    SYSLOGD_OPTIONS="-m 0"
    KLOGD_OPTIONS="-2"
fi
```

Of specific interest is the following line:

```
SYSLOGD_OPTIONS="-m 0"
```

By adding a `-r` suffix, this allows the server to accept messages from remote machines. The edited line should read as follows:

```
SYSLOGD_OPTIONS="-m 0 -r"
```

Check the services file, normally at `/etc/services`, to ensure that **PORT 514** is defined. By default this should be enabled on most machines.



NOTE

After making the changes you must restart `syslogd`.

On most machines, entering “`service syslog restart`” should complete the configuration.

² This file may be in a different location.

Appendix D. SETTING UP A DIGICAST DIGITAL SATELLITE RECEIVER

D.1 Introduction

Setting up a digital satellite receiver for the delivery of IP or transport stream information over an Asynchronous Serial Interface (ASI) involves more than just configuring the data related parameters. The person performing the configuration must have knowledge of both communications concepts and satellite communications. Section D.5, Important Terms to Understand, contains information that will help the individual performing the configuration by explaining each parameter and what parameters must be on hand when setting up a Digicast satellite receiver. It is recommended that these terms and concepts be thoroughly understood before proceeding with the setup process.

To complete the setup of a Digicast Satellite Receiver, follow these steps:

1. Understand the significant terms and parameters (Section D.5)
2. Gather the required information (Section D.2)
3. Verify frequency values (Section D.3)
4. Apply the required information to the primary and secondary configurations (Section D.4)

The following image illustrates some of the significant terms and indicates their application:

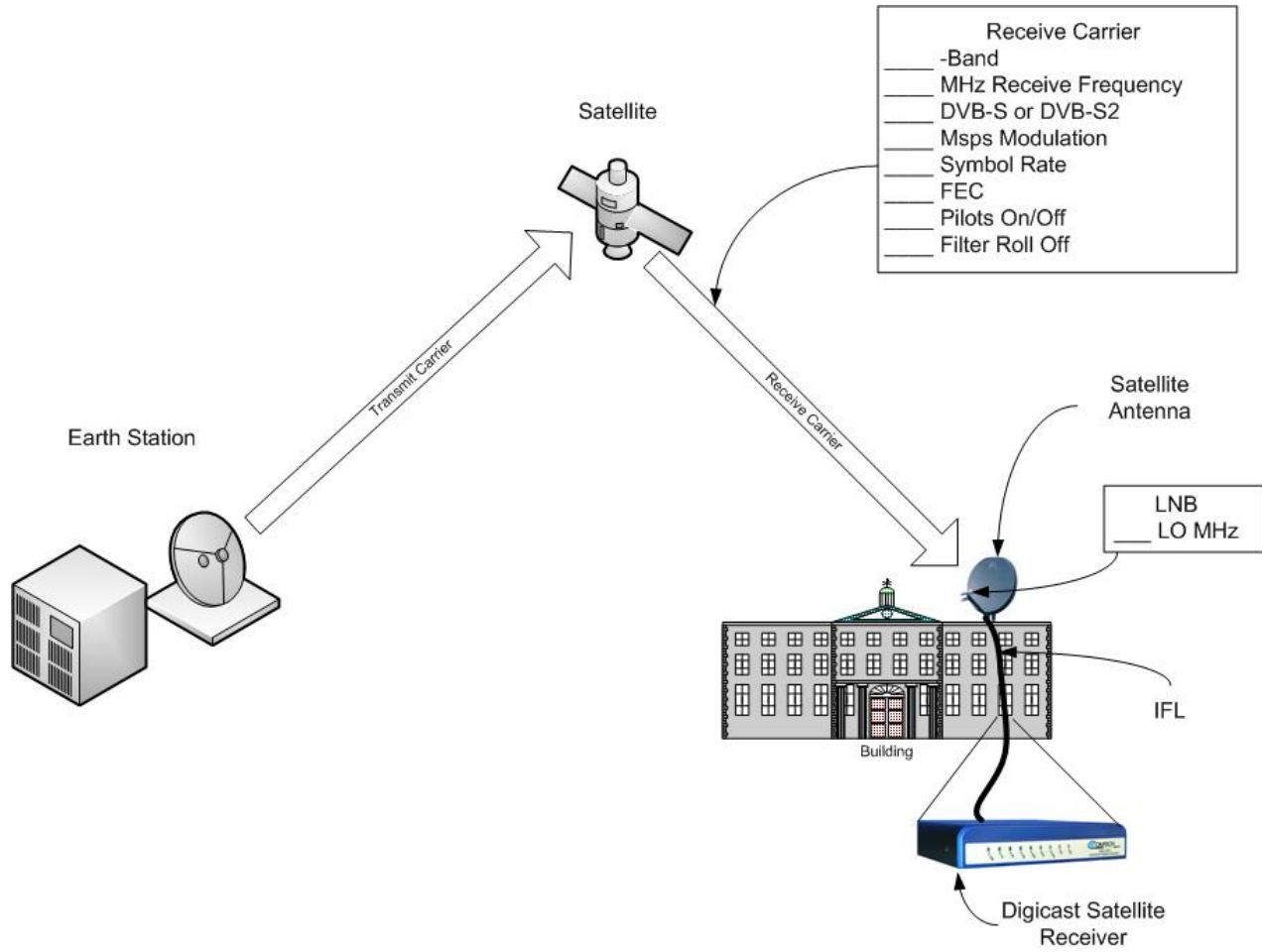

D.2 Required Information for Setting Up a Digicast Satellite Receiver

To set up the Digicast receiver for receiving a live satellite feed, gather the following data:

1. Which frequency band is being used? <input checked="" type="checkbox"/>	C-Band
	X-Band
	Ku-Band
	Ka-Band
2. Downlink frequency of the carrier from the satellite?	(MHz)
3. Local Oscillator of the LNB?	(MHz)
4. Which DVB Type? <input checked="" type="checkbox"/>	DVB-S
	DVB-S2
5. Symbol Rate?	(MSPS)
6. Which modulation of the carrier from the satellite? <input checked="" type="checkbox"/>	QPSK
	8-PSK
	16-APSK
7. FEC of the carrier from the satellite? (Range = 1/4 to 9/10 FEC)	
8. Pilots: <input checked="" type="checkbox"/>	On
	Off
9. Which Filter Roll Off (for DVB-S2 Only)? <input checked="" type="checkbox"/>	20%
	25%
	35%
10. Secondary (backup) Carrier? <input checked="" type="checkbox"/>	Enabled
	Disabled
11. Which LNB Power Requirement? <input checked="" type="checkbox"/>	None
	13 VDC
	18 VDC
12. Which Spectral Inversion mode? <input checked="" type="checkbox"/>	On
	Off
	On/Both
	Off/Both

D.3 Verify Frequency Values

The information gathered in the previous section will become the proper parameters entered into the Digicast receiver. However, before this can be done successfully, several values must be verified:

1. Verify the downlink frequency provided falls into the proper band:
 - a. C-Band – 3,700 to 4,200 MHz
 - b. X-Band – 7,000 to 12,500 MHz
 - c. Ku-Band – 11,000 to 18,000 MHz
 - d. Ka-Band – 18,000 to 40,000 MHz

If the downlink frequency does not fall within proper band, contact the space-link provider for clarification.

2. Determine the values to set for the LO and downlink frequency on the Digicast satellite receiver. There are two ways the frequencies can be loaded into the Digicast satellite receiver: 1) Directly entering the downlink and LO frequencies, or 2) by entering the values as L-Band frequencies.
 - 1) Entering the values directly provides the most convenience, since the user simply enters the downlink frequency and LO directly into the Digicast satellite receiver.
 - 2) Entering the values as an L-Band frequency requires some math to be performed, but allows those who are more comfortable with L-Band values to use those familiar frequencies.

To use L-Band frequencies in the configuration, the LO frequency must be set to 0 MHz. The downlink frequency is determined by taking the absolute difference of the actual downlink frequency at (C-, X-, Ku- or Ka-Band) and subtracting the two and using the absolute result (a non-negative number). Once this number has been found, the difference will be the L-Band frequency that can be entered into the downlink frequency on the Digicast satellite receiver. The following examples are given:

<p>Example 1: Ku-Band LO = 10,750 MHz Downlink Frequency = 11,895 MHz L-Band Frequency = 11,895 MHz – 10,750 MHz L-Band Frequency = 1,145 MHz</p>
<p>Example 2: Ku-Band LO = 10,600 MHz Downlink Frequency = 12,010 MHz L-Band Frequency = 12,010 MHz – 10,600 MHz L-Band Frequency = 1,410 MHz</p>
<p>Example 3: C-Band LO = 5,150 MHz Downlink Frequency = 3,920 MHz L-Band Frequency = 3,920 MHz – 5,150 MHz L-Band Frequency = - 1,230 MHz L-Band Frequency = 1,230 MHz</p>

D.4 Configure the Equipment

Web Interface Example

In the following Web interface graphic, the data is shown **entered two different ways** for the primary and secondary frequency configurations. The frequencies used are as follows:

Primary (entered as L-Band format):	Secondary (entered as standard format):
Ku-Band LO = 10,750 MHz Downlink Frequency = 12,425 MHz L-Band Frequency = 12,425 MHz – 10,750 MHz L-Band Frequency = 1,675 MHz Symbol Rate = 32 Msps DVB Type = DVB-S2 Modulation = 8-PSK FEC = 9/10 Spectral Inversion = Both/Off Pilot = On (DVB-S2 Only) Filter Roll Off = 20% (DVB-S2 Only)	Ku-Band LO = 10,750 MHz Downlink Frequency = 12,177 MHz Symbol Rate = 23 Msps DVB Type = DVB-S Modulation = QPSK FEC = 3/4 Spectral Inversion = Both/Off Pilot = Off (DVB-S2 Only) Filter Roll Off = 35% default (DVB-S2 Only)

The screenshot shows the Digicast MediaRouter S2 web interface. At the top, there is a navigation menu with links: HOME, ADMIN, REDUNDANCY, NETWORK, IGMP, UNICAST, MPE/IP, MPEG-TS, TUNER, and STATS. The 'TUNER' link is highlighted.

Below the navigation menu is the 'Tuner Statistics' section, which contains a table with the following data:

Lock	Es/No	Eb/No	Power	Refresh
P	17.9dB	20.6dB	-56dBm	Refresh

Below the Tuner Statistics is the 'Tuner Configuration' section, which contains a table with the following data:

Config	LNB	Downlink	Modulation	Symbol Rate (Msps)	Polarity	Spectral Inversion	22KHz Tone	Pilot (S2)	Roll Off	DiSeqC
Primary	0	1675	DVB-S2 8PSK 9/10	32.000	Horizontal (18V)	Both Off	Off	On	20%	Off
Backup	10750	12177	DVB-S QPSK 3/4	23.000	Off	Both Off	Off	Off	35%	Off

Below the Tuner Configuration table are several configuration options:

- Switch time: 0 (0=Disable, minimum=5)
- Enable EbNo Monitoring:
- EbNo error threshold: (min=-10.000000, max=40.000000)

At the bottom of the configuration section are 'Submit' and 'Cancel' buttons, and a note: 'Enter Tuner settings, press submit to make changes'. A red asterisk indicates a required field.

Terminal Interface Example

In the following Terminal interface graphic, the data is shown **entered the same way** for both the primary and secondary frequency configurations. The frequencies used are as follows:

Primary (entered as L-Band format):	Secondary (entered as standard format):
Ku-Band LO = 10,750 MHz Downlink Frequency = 11,890 MHz L-Band Frequency = 11,890 MHz – 10,750 MHz L-Band Frequency = 1,140 MHz Symbol Rate = 32 Msps DVB Type = DVB-S2 Modulation = 8-PSK FEC = 9/10 Spectral Inversion = Both/On Pilot = On (DVB-S2 Only) Filter Roll Off = 20% (DVB-S2 Only)	Ku-Band LO = 10,750 MHz Downlink Frequency = 12,700 MHz Symbol Rate = 30 Msps DVB Type = DVB-S2 Modulation = 8-PSK FEC = 9/10 Spectral Inversion = Both/On Pilot = Off (DVB-S2 Only) Filter Roll Off = 35% (DVB-S2 Only)

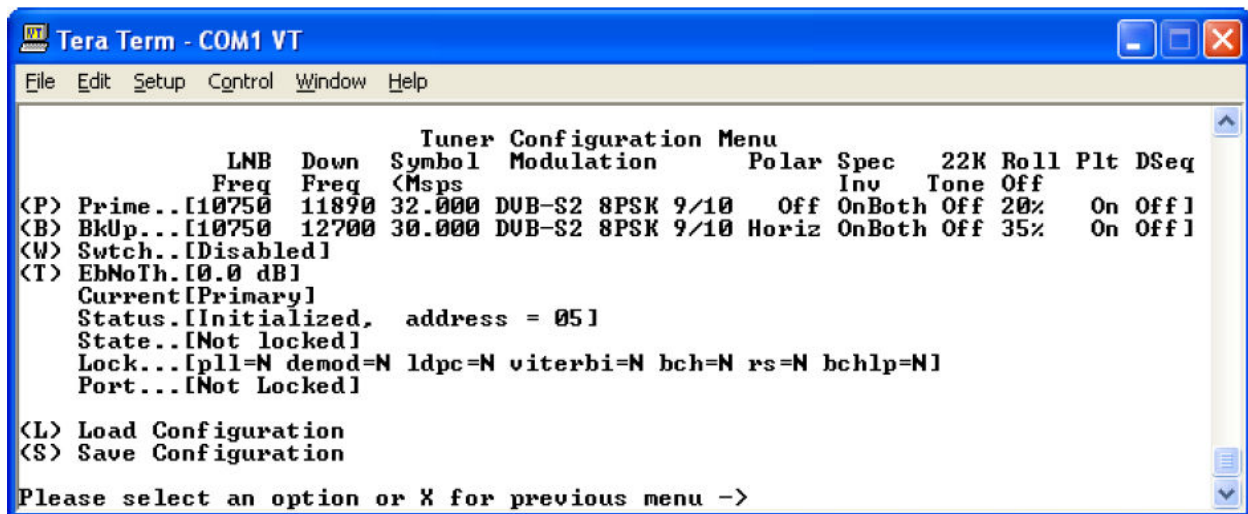

D.5 Important Terms to Understand

Backup Carrier	Whether there is a backup carrier provided.
Band	<p>The Digicast satellite receiver operates at L-Band (950 to 2,150 MHz). The LNB located up at the satellite dish, down-converts the incoming satellite signal at either C-, X-, Ku- or Ka-Band to L-Band, where it is fed into the receiver.</p> <p>The frequency bands are:</p> <p style="padding-left: 40px;">L-Band 950 to 2,150 MHz C-Band 3,700 to 4,200 MHz X-Band 7,000 to 12,500 MHz Ku-Band 11,000 to 18,000 MHz Ka-Band 18,000 to 40,000 MHz</p>
Downlink Frequency	The RF frequency received from the satellite to the remote site.
DVB	<p>Digital Video Broadcasting</p> <p>The type of DVB transmission either DVB-S or DVB-S2.</p>
Earth Station	Where the transmission signal originates
FEC	<p>Forward Error Correction</p> <p>Additional coding added to the transmission to enable the receiving site (Digicast satellite receiver) to detect and correct errors experienced during transmission over the satellite.</p>
Filter Roll Off	<p>The filter roll off is known as the Alpha coefficient (α).</p> <p>For DVB-S, α is fixed at 35%, but for DVB-S2, α can be configured as 20%, 25% or 35%. The smaller the α, the less bandwidth will be required on the satellite.</p>
IFL	<p>Interfacility Link</p> <p>The coax connecting the LNB to the Digicast satellite receiver.</p>
LNB	Low Noise Block converter.
Local Oscillator	The frequency of the local oscillator in the Low Noise Block converter.
Modulation	<p>QPSK</p> <p>8-PSK</p> <p>16-APSK</p>
Pilots	<p>On or Off</p> <p>DVB-S2 introduced the use of Pilots for allowing the satellite receiver to remain locked to the carrier under degraded signal conditions. The use of Pilots will allow the receiver to maintain carrier recovery, even when the user data payload cannot be decoded. Enabling Pilots does come at a slight bandwidth cost, since the Pilot requires 36 symbols out of every 16 payload slots, but the gain in performance offsets a minimal inefficiency.</p>

Polarization	The voltage provided to power the LNB: None – no power is provided to the LNB Horizontal – 18 VDC is provided to the LNB and can be used to switch the LNB's polarization if supported by the LNB manufacturer Vertical – 13 VDC is provided to the LNB and can be used to switch the LNB's polarization if supported by the LNB manufacturer
Receiver	Digicast satellite receiver.
Remote Site	Where the transmission signal terminates.
RF	Radio Frequency The carrier frequency used to go from the Earth to the satellite and back.
Satellite	A repeater located 22,300 miles above the Earth in geostationary orbit.
Spectral Inversion	Determines whether the spectrum is inverted or normal. For this parameter, it is recommended that On/Both or Off/Both be selected, since this will ensure the Digicast satellite receiver will automatically determine the correct spectrum.
Symbol Rate	The symbol rate for the downlink carrier in Msps (Mega symbols per second). The Symbol Rate is equivalent to the effective occupied bandwidth on the satellite transponder, but does not include the filter roll off. To determine the total occupied bandwidth on the satellite, the symbol rate is multiplied by $(1+\alpha)$, where α is the configured filter roll off of the carrier.
Uplink Frequency	The RF frequency transmitted to the satellite from the Earth Station.

Appendix E. Configuring and Controlling the Digicast CMR-5975 Media Router with SNMP

In general, to configure the Digicast CMR-5975 for web-based management via Simple Network Management Protocol (SNMP), first identify the required parameters listed below, then apply them to the unit (Section E.2).

E.1 Required SNMP Information for Configuring a Digicast Product

To set up the Digicast CMR-5975 Media Router for SNMP, the following information must be known:

1. Which version of SNMP is desired? <input checked="" type="checkbox"/>	SNMPv1
	SNMPv2c
	SNMPv3 (Not Supported)
2. What SNMP Manager will be used (informational only)?	
3. What is the IP address of the SNMP Manager?	. . .
4. What is the desired R/O Community String?	
5. What is the desired R/W Community String?	

E.2 Configuring the Digicast CMR-5975 Product for SNMP

Use the information gathered in Section E.1 to enter the proper parameters into the Digicast CMR-5975 Media Router to make it operational via the Web interface.

The screenshot displays the web interface for the Digicast MediaRouter S2. At the top, there is a navigation menu with links: HOME, ADMIN, REDUNDANCY, NETWORK, IGMP, UNICAST, MPE/TP, MPEG-TS, TUNER, and STATS. Below this is a 'Tuner Statistics' section with a table showing the following data:

Lock	Es/No	Eb/No	Power	
P	17.9dB	20.6dB	-56dBm	Refresh

Below the tuner statistics is the 'SNMP Configuration' section, which includes three input fields:

- SNMP R/W Community: *
- SNMP R/O Community: *
- SNMP server IP address: * 0.0.0.0

There are 'Submit' and 'Cancel' buttons below the input fields. A note at the bottom of the configuration section reads: 'Enter Egress settings, press submit to make changes' and '* Indicates a required field'.

There are three values that must be enabled to fully utilize all of the SNMP capabilities of the Media Router:

SNMP R/W Community: (default = private)

- The community string provided for reading and writing to the private MIB elements on the agent.
- The value entered will not be displayed to the user when entering the information or displaying the Web page.

SNMP R/O Community: (default = public)

- The community string provided for reading the private MIB elements on the agent.
- The value entered will not be displayed to the user when entering the information or displaying the Web page.

SNMP Server IP Address:

- The IP address of the SNMP server where the agent directs traps,

E.3 SNMP and Digicast Products

Digicast products may be managed using numerous protocols:

Connection Oriented Protocols	Connectionless Protocol
Web (Hypertext Transport Protocol)	SNMP
Terminal	
Telnet	

SNMP is an IP management tool that can be used to provide remote management for communications products. The SNMP protocol is a manager/agent-based design, where a manager oversees multiple agents (or remotes).

Unlike connection-oriented protocols, the SNMP protocol is based on a connectionless-oriented design, where data is exchanged between the manager and agent in a “best effort” manner – if a packet is lost, it will not be retransmitted. SNMP uses a packet structure known as a Protocol Data Unit (PDU) that uses the User Datagram Protocol (UDP) for sending information over an IP-enabled network.

There are currently three versions of SNMP in existence:

1. **SNMP version 1 (SNMPv1)** was the first version and is the most widely used today. However, SNMPv1 has serious security problems which resulted in SNMP version 2 (SNMPv2) being created.
2. **SNMPv2 and SNMPv2c** provide an improved Management Information Base (MIB), a modified PDU and enhanced security features.
3. **SNMP version 3 (SNMPv3)** was introduced to address additional security shortcomings and complexity issues existent in SNMPv2. However, SNMPv3 has not been widely accepted, and most equipment only supports SNMPv2c, which is backwards-compatible with SNMPv1.

SNMP can further be divided into more areas that involve the Management Information Base (MIB) and **polled** versus **unsolicited** messages known as *traps*. The MIB is a file that is used by the SNMP manager to identify available Object Identifiers (OIDs), otherwise known as variables that can be set or retrieved on the agent device. Two types of MIBs are described here – MIB II and private MIB.

E.4 MIB II

The SNMP MIB-II, as defined by Request for Comments (RFC) 1213, is a compilation of OIDs fashioned in a hierarchical structure, as shown below:

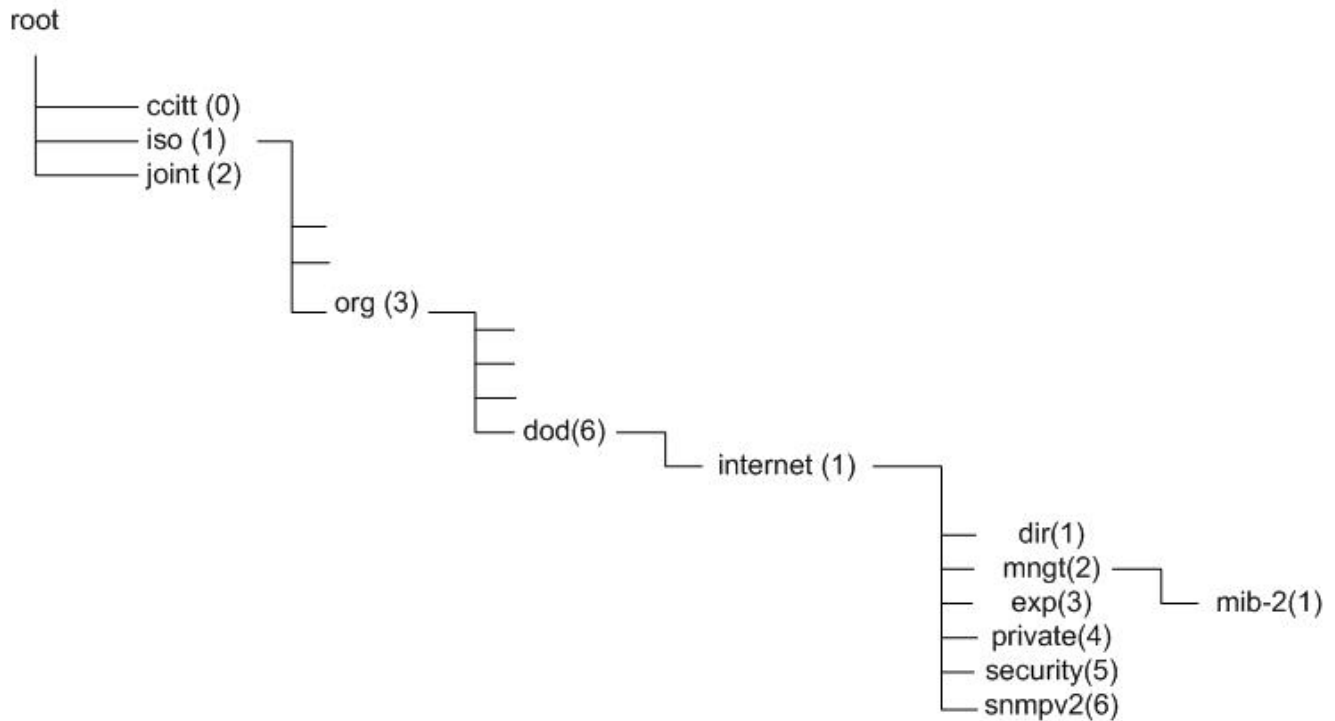

The resulting notation used inside the MIB is represented in dotted decimal notation as follows:

1.3.6.1.2.1.
1 = iso
3 = org
6 = dod
1 = internet
2 = mngt
1 = mib-2
etc.

Any remaining digits to the right of the last digit shown are sub elements and represent the actual variables in the MIB.

E.4.1 MIB II OIDs on the Digicast Media Router (Model CMR-5975)

The following describes how MIB-II elements (OIDs) can be used to obtain (GET) information from a Digicast CMR-5975 product:

The MIB-II elements are broken down into sections as follows:

MIB-II Number	Type	Description
mib-II 1	system	General information about device for administration purposes
mib-II 2	interfaces	Keeps track of each interface on device
mib-II 3	at	Address translation (only for backward compatibility)
mib-II 4	ip	Tracks IP (Internet Protocol) aspects
mib-II 5	icmp	Tracks ICMP (Internet Control Message Protocol) aspects
mib-II 6	tcp	Tracks TCP (Transmission Control Protocol) aspects
mib-II 7	udp	Tracks UDP (User Datagram Protocol) aspects
mib-II 8	egp	Tracks EGP (Exterior Gateway Protocol) aspects
mib-II 9	(no longer used)	
mib-II 10	transmission - currently not used	
mib-II 11	snmp	Tracks SNMP aspects

Supported MIB-II OIDs on the Digicast CMR-5975 Media Router product are as follows:

MIB-II Number	Type	Sub Type	OID	Description	Supported
mib-II 1	system		1.3.6.1.2.1.1	General information about device for administration purposes	
		sysDescr	1.3.6.1.2.1.1.1	System Description	Yes
		sysObjectID	1.3.6.1.2.1.1.2	System Object ID	Yes
		sysUpTime	1.3.6.1.2.1.1.3	System Up Time	Yes
		sysContact	1.3.6.1.2.1.1.4	System Contact	Yes
		sysName	1.3.6.1.2.1.1.5	System Name	Yes
		sysLocation	1.3.6.1.2.1.1.6	System Location	Yes
		sysServices	1.3.6.1.2.1.1.7	System Services	Yes
mib-II 2	interfaces		1.3.6.1.2.1.2	Keeps track of each interface on device	
		ifNumber	1.3.6.1.2.1.2.1	Interface Number	Yes
		ifTable	1.3.6.1.2.1.2.2	Interface Table	Yes
mib-II 3	at		1.3.6.1.2.1.3	Address translation (only for backward compatibility)	
		atTable	1.3.6.1.2.1.3.1	Address Translation	No
mib-II 4	ip		1.3.6.1.2.1.4	Tracks IP (Internet Protocol)	

MIB-II Number	Type	Sub Type	OID	Description	Supported
				aspects	
		ipForwarding	1.3.6.1.2.1.4.1	IP Forwarding Enabled	No
		ipDefaultTTL	1.3.6.1.2.1.4.2	IP Default Time-to-Live	Yes
		ipInReceives	1.3.6.1.2.1.4.3	IP In Received	Yes
		ipInHdrErrors	1.3.6.1.2.1.4.4	IP In Header Errors	Yes
		ipInAddrErrors	1.3.6.1.2.1.4.5	IP In Address Errors	Yes
		ipForwDatagrams	1.3.6.1.2.1.4.6	IP Forwarded Datagrams	Yes
		ipInUnknownProtos	1.3.6.1.2.1.4.7	IP In Unknown Protocol	Yes
		ipInDiscards	1.3.6.1.2.1.4.8	IP In Discards	Yes
		ipInDelivers	1.3.6.1.2.1.4.9	IP In Deliveries	Yes
		ipOutRequests	1.3.6.1.2.1.4.10	IP Out Requests	Yes
		ipOutDiscards	1.3.6.1.2.1.4.11	IP Out Discards	Yes
		ipOutNoRoutes	1.3.6.1.2.1.4.12	IP Out No Route	Yes
		ipReasmTimeout	1.3.6.1.2.1.4.13	IP Reassembly Timeouts	Yes
		ipReasmReqds	1.3.6.1.2.1.4.14	IP Reassembly Reqs	Yes
		ipReasmOKs	1.3.6.1.2.1.4.15	IP Reassembly Okays	Yes
		ipReasmFails	1.3.6.1.2.1.4.16	IP Reassembly Fails	Yes
		ipFragOKs	1.3.6.1.2.1.4.17	IP Fragmentation Okay	Yes
		ipFragFails	1.3.6.1.2.1.4.18	IP Fragmentation Fails	Yes
		ipFragCreates	1.3.6.1.2.1.4.19	IP Fragmentation Creates	Yes
		ipAddrTable	1.3.6.1.2.1.4.20	IP Address Table	Yes
		ipRouteTable	1.3.6.1.2.1.4.21	IP Route Table	Yes
		ipNetToMediaTable	1.3.6.1.2.1.4.22	IP Net to Media Table	Yes
		ipRoutingDiscards	1.3.6.1.2.1.4.23	IP Routing Discards	Yes
mib-II 5	icmp		1.3.6.1.2.1.5	Tracks ICMP (Internet Control Message Protocol) aspects	
		icmplnMsgs	1.3.6.1.2.1.5.1	ICMP In Messages	Yes
		icmplnErrors	1.3.6.1.2.1.5.2	ICMP In Errors	Yes
		icmplnDestUnreachs	1.3.6.1.2.1.5.3	ICMP In Dest Unreachable	Yes
		icmplnTimeExcds	1.3.6.1.2.1.5.4	ICMP In Time Exceeds	Yes
		icmplnParmProbs	1.3.6.1.2.1.5.5	ICMP In Parm Problems	Yes
		icmplnSrcQuenchs	1.3.6.1.2.1.5.6	ICMP In Source Quench	Yes
		icmplnRedirects	1.3.6.1.2.1.5.7	ICMP In Redirects	Yes
		icmplnEchos	1.3.6.1.2.1.5.8	ICMP In Echoes	Yes
		icmplnEchoReps	1.3.6.1.2.1.5.9	ICMP In Echo Reps	Yes
		icmplnTimestamps	1.3.6.1.2.1.5.10	ICMP In Time Stamps	Yes
		icmplnTimestampReps	1.3.6.1.2.1.5.11	ICMP In Time Stamp Reps	Yes
		icmplnAddrMasks	1.3.6.1.2.1.5.12	ICMP In Address Masks	Yes

MIB-II Number	Type	Sub Type	OID	Description	Supported
		icmpInAddrMaskReps	1.3.6.1.2.1.5.13	ICMP In Address Mask Reps	Yes
		icmpOutMsgs	1.3.6.1.2.1.5.14	ICMP Out Messages	Yes
		icmpOutErrors	1.3.6.1.2.1.5.15	ICMP Out Errors	Yes
		icmpOutDestUnreachs	1.3.6.1.2.1.5.16	ICMP Out Dest Unreachable	Yes
		icmpOutTimeExcds	1.3.6.1.2.1.5.17	ICMP Out Time Exceeds	Yes
		icmpOutParmProbs	1.3.6.1.2.1.5.18	ICMP Out Parm Problems	Yes
		icmpOutSrcQuenchs	1.3.6.1.2.1.5.19	ICMP Out Source Quench	Yes
		icmpOutRedirects	1.3.6.1.2.1.5.20	ICMP Out Redirects	Yes
		icmpOutEchos	1.3.6.1.2.1.5.21	ICMP Out Echoes	Yes
		icmpOutEchoReps	1.3.6.1.2.1.5.22	ICMP out Echo Reps	Yes
		icmpOutTimestamps	1.3.6.1.2.1.5.23	ICMP Out Time Stamps	Yes
		icmpOutTimestampReps	1.3.6.1.2.1.5.24	ICMP Out TimeStamp Reps	Yes
		icmpOutAddrMasks	1.3.6.1.2.1.5.25	ICMP Out Addr Masks	Yes
		icmpOutAddrMaskReps	1.3.6.1.2.1.5.26	ICMP Out Address Mask Rep	Yes
mib-II 6	tcp		1.3.6.1.2.1.6	Tracks TCP (Transmission Control Protocol) aspects	
		tcpRtoAlgorithm	1.3.6.1.2.1.6.1	TCP Retrans Algorithm	Yes
		tcpRtoMin	1.3.6.1.2.1.6.2	TCP Retrans Min	Yes
		tcpRtoMax	1.3.6.1.2.1.6.3	TCP Retrans Max	Yes
		tcpMaxConn	1.3.6.1.2.1.6.4	TCP Max Conn	Yes
		tcpActiveOpens	1.3.6.1.2.1.6.5	TCP Active Conn Open	Yes
		tcpPassiveOpens	1.3.6.1.2.1.6.6	TCP Passive Conn Open	Yes
		tcpAttemptFails	1.3.6.1.2.1.6.7	TCP Attempts Failed	Yes
		tcpEstabResets	1.3.6.1.2.1.6.8	TCP Established Resets	Yes
		tcpCurrEstab	1.3.6.1.2.1.6.9	TCP Current Connections	Yes
		tcpInSegs	1.3.6.1.2.1.6.10	TCP In Segments	Yes
		tcpOutSegs	1.3.6.1.2.1.6.11	TCP Out Segments	Yes
		tcpRetransSegs	1.3.6.1.2.1.6.12	TCP Retransmitted Segments	Yes
		tcpConnTable	1.3.6.1.2.1.6.13	TCP Connection Table	Yes
		tcpInErrs	1.3.6.1.2.1.6.14	TCP In Errors	Yes
		tcpOutRsts	1.3.6.1.2.1.6.15	TCP Out Resets	Yes
mib-II 7	udp		1.3.6.1.2.1.7	Tracks UDP (User Datagram Protocol) aspects	
		udpInDatagrams	1.3.6.1.2.1.7.1	UDP In Datagrams Received	Yes
		udpNoPorts	1.3.6.1.2.1.7.2	UDP No Ports Available	Yes
		udpInErrors	1.3.6.1.2.1.7.3	UDP In Errors	Yes
		udpOutDatagrams	1.3.6.1.2.1.7.4	UDP Out Datagrams Sent	Yes

MIB-II Number	Type	Sub Type	OID	Description	Supported
		udpTable	1.3.6.1.2.1.7.5	UDP Table	No
mib-II 8	egp			Tracks EGP (Exterior Gateway Protocol) aspects	No
mib-II 9	(no longer used)				
mib-II 10	transmission - currently not used				
mib-II 11	snmp		1.3.6.1.2.1.11	Tracks SNMP aspects	
		snmpInPkts	1.3.6.1.2.1.11.1	SNMP In Packets	Yes
		snmpOutPkts	1.3.6.1.2.1.11.2	SNMP Out Packets	Yes
		snmpInBadVersions	1.3.6.1.2.1.11.3	SNMP Bad Version Numbers	Yes
		snmpInBadCommunityNames	1.3.6.1.2.1.11.4	SNMP In Bad Comm Names	Yes
		snmpInBadCommunityUses	1.3.6.1.2.1.11.5	SNMP In Bad Comm Users	Yes
		snmpInASNParseErrs	1.3.6.1.2.1.11.6	SNMP In ASN Parse Errors	Yes
		snmpInTooBigs	1.3.6.1.2.1.11.8	SNMP In too Big	Yes
		snmpInNoSuchNames	1.3.6.1.2.1.11.9	SNMP In No Such Name	Yes
		snmpInBadValues	1.3.6.1.2.1.11.10	SNMP In Bad Values	Yes
		snmpInReadOnlys	1.3.6.1.2.1.11.11	SNMP In Read Onlys	Yes
		snmpInGenErrs	1.3.6.1.2.1.11.12	SNMP In Gen Errors	Yes
		snmpInTotalReqVars	1.3.6.1.2.1.11.13	SNMP In Total Req Variables	Yes
		snmpInTotalSetVars	1.3.6.1.2.1.11.14	SNMP In Total Set Variables	Yes
		snmpInGetRequests	1.3.6.1.2.1.11.15	SNMP In Get Requests	Yes
		snmpInGetNexts	1.3.6.1.2.1.11.16	SNMP IN Get Nexts	Yes
		snmpInSetRequests	1.3.6.1.2.1.11.17	SNMP In Set Requests	Yes
		snmpInGetResponses	1.3.6.1.2.1.11.18	SNMP In Get Responses	Yes
		snmpInTraps	1.3.6.1.2.1.11.19	SNMP In Traps	Yes
		snmpOutTooBigs	1.3.6.1.2.1.11.20	SNMP Out Too Bigs	Yes

MIB-II Number	Type	Sub Type	OID	Description	Supported
		snmpOutNoSuchNames	1.3.6.1.2.1.11.21	SNMP Out No Such Name	Yes
		snmpOutBadValues	1.3.6.1.2.1.11.22	SNMP Out Bad Values	Yes
		snmpOutGenErrs	1.3.6.1.2.1.11.24	SNMP Out Gen Errors	Yes
		snmpOutGetRequests	1.3.6.1.2.1.11.25	SNMP Out Get Requests	Yes
		snmpOutGetNexts	1.3.6.1.2.1.11.26	SNMP Out Get Nexts	Yes
		snmpOutSetRequests	1.3.6.1.2.1.11.27	SNMP Out Set Requests	Yes
		snmpOutGetResponses	1.3.6.1.2.1.11.28	SNMP Out Get Responses	Yes
		snmpOutTraps	1.3.6.1.2.1.11.29	SNMP Out Traps	No
		snmpEnableAuthenTraps	1.3.6.1.2.1.11.30	SNMP Enable Auth Traps	No

The MIB-II Traps are broken down as follows:

Trap Name	Description
dniColdStart	Cold start: The unit is starting up from a down state
dniWarmStart	Warm Start: The unit is recovering from a reset incident
dniLinkDown	Link Down: The receiver has lost its L-Band signal
dniLinkUp	Link Up: The L-Band signal has been reestablished
dniAuthFail	Authentication Failure: An SNMP message received could not be authenticated

E.5 Private MIB

Comtech EF Data's Digicast private enterprise number is 18732. Therefore, the private MIB for Comtech EF Data's Digicast products is as follows:

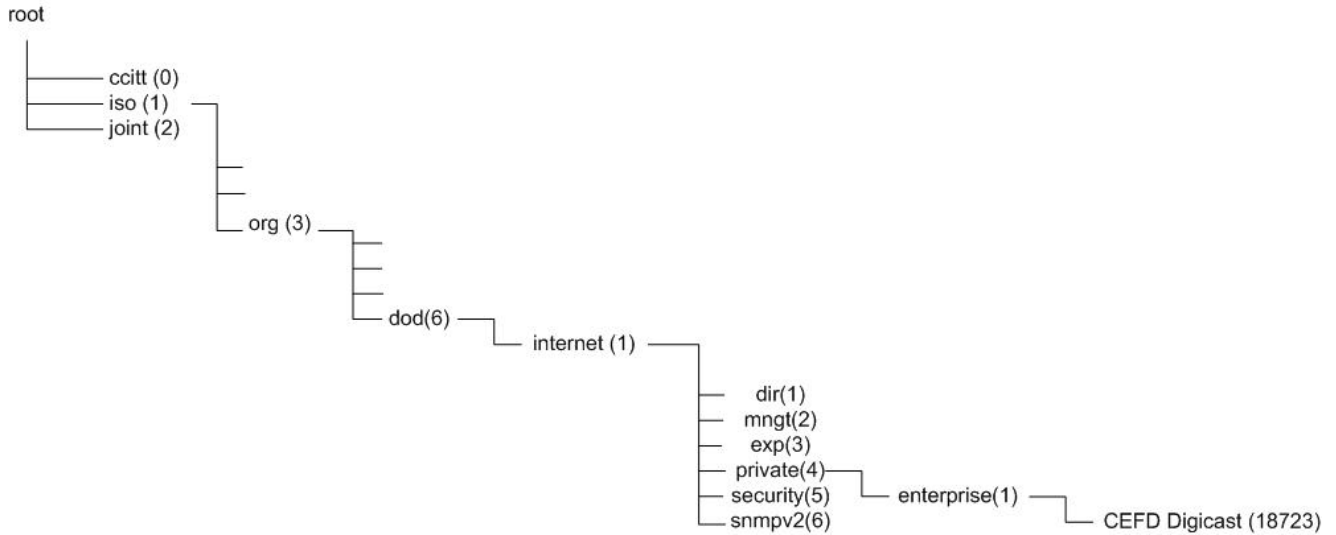

1.3.6.1.4.1.18723.

1 = iso

3 = org

6 = dod

1 = internet

4 = private

1 = enterprise

18723 = Comtech EF Data's Digicast Enterprise Number

etc.

E.5.1 Private MIB OIDs on Digicast Products

The following describes how the Enterprise (Private) MIB elements (OIDs) can be used to obtain (GET) information or configure (SET) a parameter on the Digicast CMR-5975 Media Router.

The Enterprise MIB elements (OIDs) are broken down as follows:

OID Number	OID	Description	GET or SET
1.3.6.1.4.1.18723.5975.1.1	dniAggregateStatsTunerStats	Tuner Statistics	GET
1.3.6.1.4.1.18723.5975.1.2	dniAggregateStatsTunerAcquiState	Tuner Acquisition State	GET
1.3.6.1.4.1.18723.5975.1.3	dniAggregateStatsEsNo	Es/No in dB	GET
1.3.6.1.4.1.18723.5975.1.4	dniAggregateStatsEbNo	Eb/No in dB	GET

The Enterprise Traps are broken down as follows:

Trap Name	Description
software reset	Software Reset has occurred
dropping packets	Unit is dropping packets
dropping packets cleared	Unit has stopped dropping packets
redundancy primary on	Redundancy – Primary Online
redundancy backup on	Redundancy – Backup Online
dniEbNoThreshold	EbNo value is now set above the defined limit
dniEbNoThresholdFail	EbNo value has fallen below the defined limit
dniRedundancyBackup	Redundant backup unit is now active
dniRedundancyPrimary	Redundant primary unit is now active
dniRedundancyModeConflict	A conflict in redundancy mode has been detected
dniMPEGPIDConflict	MPEG-TS PID Conflict has occurred
dniDMAOverflow	DMA Overflow
dniDMAOverflowCleared	DMA Overflow Cleared

E.6 Important Terms to Know

Get	Obtain an element (OID) of information from a agent.
GetNext	Obtains the next element (OID) of information from a agent.
GetResponse	Requests a response from the agent for information.
MIB	Message Information Base is the file that defines all the supported OIDs at the agent.
MIB II	Message Information Base II which is a MIB that is supported by most PC and communications products. MIB II is described in Request for Comments RFC 1213.
OID	Object Identifier is the variable on the agent that can be configured (SET) or obtained (GET).
PDU	Protocol Data Unit is the message that carries all SNMP messages over a network.
Private MIB	The manufacturer created and defined MIB describing the OIDs that may be configured (SET) or obtained (GET) from an agent product.
R/O Community	The community string for read only access to the MIB elements.
R/W Community	The community string for read/write access to the MIB elements.
Set	Set an element (OID) of information on a agent.
SNMP Agent	The agent (remote) that is managed by an SNMP manager.
SNMP Manager	The manager and collection point for SNMP-enabled remote agents.
Trap	an unsolicited message sent to the SNMP server from the SNMP Agent.

The following image depicts these terms and indicates where they apply:

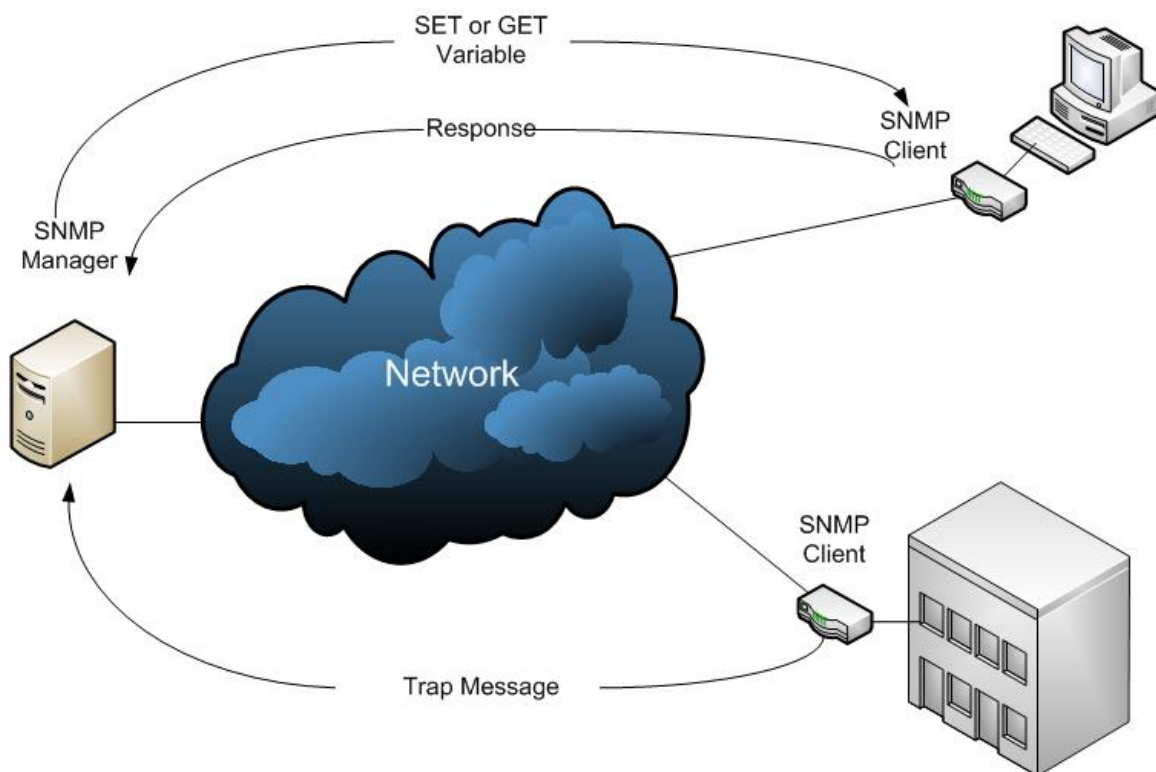

Appendix F. DVB-S/S2 BER Performance at Quasi-Error Free (QEF)

The Forward Error Correction (FEC) technique used in Digicast receivers complies with ETSI EN 300 421 for DVB-S and ETSI EN 302 307 for DVB-S2. The information provided below demonstrates the Es/No to provide "Quasi Error Free" (QEF) performance for a packet error rate PER of 10^{-7} . A PER of 10^{-7} corresponds to an approximate BER in the order of 3×10^{-10} .

Test Configuration:

Symbol Rate: 20 Msps
Frame Size = 64,800 (Normal Frames)
Pilots: Off
Roll Off: 35%
Nominal Input Power: -48 dB
L-Band Frequency: 1,170 MHz
Input Range: -25 to -50 dBm

Assumptions:

QEF = 10^{-7} PER
Es/No = C/N

Recorded Data DVB-S:

Type	Modulation	FEC	Es/No dB
DVB-S	QPSK	1/2	2.92
DVB-S	QPSK	2/3	4.67
DVB-S	QPSK	3/4	5.76
DVB-S	QPSK	5/6	6.73
DVB-S	QPSK	7/8	7.49

Recorded Data DVB-S2 Pilots Off (Disabled):

Type	Modulation	FEC	Es/No dB
DVB-S2	QPSK	1/2	1.82
DVB-S2	QPSK	3/5	2.72
DVB-S2	QPSK	2/3	3.49
DVB-S2	QPSK	3/4	4.32
DVB-S2	QPSK	4/5	5.05
DVB-S2	QPSK	5/6	5.58
DVB-S2	QPSK	8/9	6.67
DVB-S2	QPSK	9/10	6.78
DVB-S2	8-PSK	3/5	7.74
DVB-S2	8-PSK	2/3	7.70
DVB-S2	8-PSK	3/4	8.43
DVB-S2	8-PSK	5/6	9.86
DVB-S2	8-PSK	8/9	11.36
DVB-S2	8-PSK	9/10	11.69

Recorded Data DVB-S2 Pilots On (Enabled):

Type	Modulation	FEC	Es/No dB
DVB-S2	QPSK	1/2	1.74
DVB-S2	QPSK	3/5	2.60
DVB-S2	QPSK	2/3	3.41
DVB-S2	QPSK	3/4	4.44
DVB-S2	QPSK	4/5	5.03
DVB-S2	QPSK	5/6	5.60
DVB-S2	QPSK	8/9	6.61
DVB-S2	QPSK	9/10	6.96
DVB-S2	8-PSK	3/5	5.98
DVB-S2	8-PSK	2/3	7.24
DVB-S2	8-PSK	3/4	8.63
DVB-S2	8-PSK	5/6	10.27
DVB-S2	8-PSK	8/9	11.93
DVB-S2	8-PSK	9/10	12.44

METRIC CONVERSIONS

Units of Length

Unit	Centimeter	Inch	Foot	Yard	Mile	Meter	Kilometer	Millimeter
1 centimeter	—	0.3937	0.03281	0.01094	6.214×10^{-6}	0.01	—	—
1 inch	2.540	—	0.08333	0.2778	1.578×10^{-5}	0.254	—	25.4
1 foot	30.480	12.0	—	0.3333	1.893×10^{-4}	0.3048	—	—
1 yard	91.44	36.0	3.0	—	5.679×10^{-4}	0.9144	—	—
1 meter	100.0	39.37	3.281	1.094	6.214×10^{-4}	—	—	—
1 mile	1.609×10^5	6.336×10^4	5.280×10^3	1.760×10^3	—	1.609×10^3	1.609	—
1 mm	—	0.03937	—	—	—	—	—	—
1 kilometer	—	—	—	—	0.621	—	—	—

Temperature Conversions

Unit	° Fahrenheit	° Centigrade
32° Fahrenheit	—	0 (water freezes)
212° Fahrenheit	—	100 (water boils)
-459.6° Fahrenheit	—	273.1 (absolute 0)

Formulas
$C = (F - 32) * 0.555$
$F = (C * 1.8) + 32$

Units of Weight

Unit	Gram	Ounce Avoirdupois	Ounce Troy	Pound Avoir.	Pound Troy	Kilogram
1 gram	—	0.03527	0.03215	0.002205	0.002679	0.001
1 oz. avoir.	28.35	—	0.9115	0.0625	0.07595	0.02835
1 oz. troy	31.10	1.097	—	0.06857	0.08333	0.03110
1 lb. avoir.	453.6	16.0	14.58	—	1.215	0.4536
1 lb. Troy	373.2	13.17	12.0	0.8229	—	0.3732
1 kilogram	1.0×10^3	35.27	32.15	2.205	2.679	—



2114 WEST 7TH STREET TEMPE ARIZONA 85281 USA
480 • 333 • 2200 PHONE
480 • 333 • 2161 FAX