



CDM-625A

**Advanced Satellite Modem (18 kbps – 25 Mbps)
Installation and Operation Manual**
For Firmware Version 1.4.1 or higher

IMPORTANT NOTE: The information contained in this document supersedes all previously published information regarding this product. Product specifications are subject to change without prior notice.

Errata C for MN-CDM625A Rev 4

Comtech EF Data Documentation Update

CDM-625A

**Advanced Satellite Modem (18 kbps – 25 Mbps)
Installation and Operation Manual**

For Firmware Version 1.4.1 or higher

Part Number MN-CDM625A / CD-MN-CDM625A
Revision 4

Subject: Section 1.4.1 Modulator - Revised Operating Frequency to be 950 - 2250 MHz and Section 10.3.3.1.1. CONFIG: Tx > Freq and CONFIG: Rx > Freq Submenus - Revised available frequency range for L-Band to be 950-2250 MHz

Errata Part Number: ER-CDM625A-EC4 (*Errata documents are not revised*)

PLM CO Number: C-0038141

Comments: See attached page(s). The new information will be included in the next released revision of the manual.

1.4 Summary of Specifications

1.4.1 Modulator

Modulation	BPSK, QPSK, OQPSK, 8PSK, 8-QAM and 16-QAM
Symbol rate range	18 kbps to 12.5 Msps
Data rate range	18 kbps - 25 Mbps. See Section 1.4.7
Operating frequency	50 - 180 MHz (BNC connector) AND 950 - 2250 MHz (Type 'N' connector), 100 Hz resolution Stability ± 0.06 ppm ($\pm 6 \times 10^{-3}$) 0° to 50°C (32° to 122°F), when using internal reference
Operating modes	<ul style="list-style-type: none"> • Open Network, per Intelsat IESS-308/309/310/314 (IDR, IBS/SMS) • E1/T1 Drop and Insert • Transparent, Closed Network, IESS-315 (VSAT Turbo) • Proprietary EDMAC framed mode: <ul style="list-style-type: none"> • 5% overhead – EDMAC (data rates < 2.048 Mbps all modes except BPSK Turbo, Rate 21/44 QPSK Turbo) • 1.6% overhead - EDMAC-2 (rates >2.048 Mbps and all Rate 21/44, 5/16 Turbo) • EDMAC-3 – for SNMP Proxy – same as EDMAC • R-S Outer Codec • Turbo Product Codec - 2nd Generation (optional plug-in module) • LDPC Codec (optional plug-in module – includes all 2nd Generation TPC modes) • VersaFEC[®]-Codec (short-block, low latency and ultra-low-latency LDPC) • VersaFEC-2[®]-Codec (optional plug-in module, long-block, short-block) • VersaFEC[®]-Adaptive Coding and Modulation – IP interface only – maximum symbol rate = 4.1 Msps • VersaFEC-2[®]-Adaptive Coding and Modulation – IP interface only – maximum symbol rate = 12.5 Msps • Automatic Uplink Power Control (AUPC) mode • High Rate ESC, Enhanced ESC (ESC++) • Enhanced Drop & Insert (D&I++) • Quad E1 Drop & Insert (QDI) - concatenates time slots from up to four E1 G.703 streams, Framed QDI • DoubleTalk[®] Carrier-in-Carrier[®] mode • Carrier-in-Carrier Automatic Power Control (CnC-APC)
FEC	<p>None: Uncoded BPSK/QPSK/OQPSK</p> <p>Viterbi: k=7, per IESS-308/309</p> <p>BPSK: Rate 1/2</p> <p>QPSK/OQPSK: Rate 1/2, Rate 3/4 and Rate 7/8</p> <p>16-QAM: Rate 3/4 and Rate 7/8 (Viterbi plus Reed-Solomon only)</p> <p>Sequential:</p> <p>BPSK: Rate 1/2</p> <p>QPSK/OQPSK: Rate 1/2, Rate 3/4 and Rate 7/8</p> <p>Reed-Solomon (Open Network):</p> <p>IDR modes:</p> <p>225/205 for T1</p> <p>219/201 for E1 and IESS-310 mode,</p> <p>194/178 for T2 and E2</p> <p>IBS modes:</p> <p>126/112 and 219/201 for IESS-310 mode</p> <p>Reed-Solomon (Closed Network):</p> <p>220,200 outer code (transparent mode)</p> <p>225,205 outer code (transparent mode, EF Data compatible, V.35 scrambling)</p> <p>126,112 outer code (transparent mode, IBS parameters, D&I++ mode)</p> <p>219,201 outer code (transparent mode, IESS-310 parameters)</p> <p>200,180 outer code (EDMAC modes)</p> <p>Interleaver depth = 4 or 8 (depending on mode)</p> <p>8PSK/TCM Rate 2/3 (Trellis): Per IESS-310</p> <p>Turbo Product Codec, 2nd Generation (Optional plug-in card, includes LDPC modes):</p> <p>Rate 5/16 (2 dimensional) and Rate 21/44 (3-dimensional) BPSK</p> <p>Rate 21/44 QPSK/OQPSK (aka 1/2) - 3 dimensional</p> <p>Rate 3/4 QPSK/OQPSK/8PSK/8-QAM/16-QAM - 2 dimensional</p> <p>Rate 7/8 QPSK/OQPSK/8PSK/8-QAM/16-QAM - 2 dimensional</p> <p>Rate 0.95 QPSK/OQPSK/8PSK/8-QAM/- 2 dimensional TPC (exact Code Rate is actually 17/18, or 0.944)</p>

10.3.3.1 (SELECT: CONFIGURATION) Menu Branches

```
CONFIG: All Mode Tx Rx Clocks D&I/ACM
CnC EDMAC Misc Mask Remote IP (◀ ▶)
```

Use the ◀▶ arrow keys to select Tx, Rx, or Mask, and then press ENTER.

10.3.3.1.1 CONFIG: Tx → Freq and CONFIG: Rx → Freq Submenus

```
Tx-IF Frequency: 1750.0000 MHz
(LO:12500 MHz Sat:14250.0000 MHz) (◀ ▶ ⬆ ⬇)
```

```
Rx-IF Frequency: 1200.0000 MHz
(LO:12500 MHz Sat:13700.0000 MHz) (◀ ▶ ⬆ ⬇)
```

When you use the ODU menus to configure a BUC or LNB LO-frequency, the **CONFIG: Tx→Freq** and **CONFIG: Rx→Freq** menu screens provide supplemental information on the bottom line. As you edit the IF frequency, the Satellite frequency updates accordingly.



Satellite frequency = LO ± IF frequency, where the ± sign is determined by the LO mix setting:

- High-sided mix [-] (includes a spectral inversion);
- Low-sided mix [+].

To edit the Tx-IF or Rx Frequency, use the ◀▶ arrow keys to select a digit to edit, and then use the ▲▼ arrow keys to change that digit. The available ranges are 50-180 MHz, and 950-2250 MHz (L-Band) (FAST option). The resolution is 100Hz. Press ENTER when done.

10.3.3.1.2 (SELECT: CONFIGURATION) Mask Submenus

The Mask submenus allow you to selectively mask (ignore) or make active various alarms and traffic conditions that are monitored by the modem.

```
Alarm Masks: AIS Buffer Ref RxIF TxClk
TxSat RxSat Terr ROP BUC LNB CEX (◀ ▶)
```

Use the ◀▶ arrow keys to select BUC or LNB, and then press ENTER.

BLANK PAGE

Errata B for MN-CDM625A Rev 4

Comtech EF Data Documentation Update

CDM-625A

Advanced Satellite Modem (18 kbps – 25 Mbps)

Installation and Operation Manual

For Firmware Version 1.4.1 or higher

Part Number MN-CDM625A / CD-MN-CDM625A

Revision 4

Subject: Change page 8-62, EGC command arguments.

Errata Part Number: ER-CDM625A-EB4 (*Errata documents are not revised*)

PLM CO Number: C-0037089

Comments: See attached page(s). The new information will be included in the next released revision of the manual.

8.5.10 Ethernet Parameters

Parameter	Command (Instruction & Qualifier)	Number of Arguments	Description of Arguments	Response to Command	Query (Instruction & Qualifier)	Response to Query
Ethernet Control	SEC=	31 bytes	Command or Query. Sets or returns Ethernet control in the form 1abbbb;2abbbb;3abbbb;4abbbb, where: 1, 2, 3, 4 is port number. a=Reserved, default to 1. bbbb=Reserved, default to 0001. c=port speed: 0=Auto 1=100 Full 2=100 Half 3=10 Full 4=10 Half	SEC= SEC? SEC* SEC#	SEC?	SEC=1abbbb;2abbbb;3abbbb;4abbbb (see Description of Arguments)
Actual Negotiated Port Speed	N/A	None	Query only. Returns the actual negotiated port speed in the form abcd, where: a=port 1 negotiated port speed. b=port 2 negotiated port speed. c=port 3 negotiated port speed. d=port 4 negotiated port speed. a, b, c, d have the following values: 0=Link down 1=100 Full 2=100 Half 3=10 Full 4=10 Half	N/A	NPS?	NPS=abcd (see Description of Arguments)
Ethernet Global Configuration	EGC=	Up to 347 bytes	Command or Query. Sets or returns Global Configuration of CDM-625A Ethernet, in the form shown in the Response to Query column, where: 1abccccdaaa;2abccccdaaa;3abccccdaaa;4abccccdaaa=Switch Ports configuration same as SPC D=VLAN Mode Enable same as SVM E=Switch MAC Learning same as SML FF=QoS Priority same as QOS G=Ethernet 2048 Frame Size same as EFS H=Precision Time Protocol Feature same as PTP I=Precision Time Protocol Mode same as PTM J=Precision Time Protocol Transport Mode same as PTU KKK.KKK.KKK.KKK=PTP Unicast Master same as PTS LL=Precision Time Protocol Unicast Sync Interval same as PTY M=SNTP Enable same as TPE NNN.NNN.NNN.NNN=SNTP Primary Server same as TPS OOO.OOO.OOO.OOO=SNTP Backup Server same as TPB PP=SNTP Time Zone same as TPZ Q=Carrier ID State same as CAI RRRR=Management VLAN ID same as SMV SSSS....=VLAN Table same as SVT	EGC= EGC? EGC* EGC#	EGC? EGC?n (where n=0 thru 9). Returns the EGC portion of 1 of 10 stored configurations)	EGC=1abccccdaaa;2abccccdaaa;3abccccdaaa;4abccccdaaa;DEFF GHUIKKK.KKK.KKKLL MNNN.NNN.NNN.NN NOOO.OOO.OOO.O OOPPQRRRRSSSS (see Description of Arguments)

Errata A for MN-CDM625A Rev 4

Comtech EF Data Documentation Update

CDM-625A

Advanced Satellite Modem (18 kbps – 25 Mbps)

Installation and Operation Manual

For Firmware Version 1.4.1 or higher

Part Number MN-CDM625A / CD-MN-CDM625A

Revision 4

Subject: Change page 1-8, IP Packet Processor AES Encryption Installation Method to Available as EN model.

Errata Part Number: ER-CDM625A-EA4 (*Errata documents are not revised*)

PLM CO Number: C-0035152

Comments: See attached page(s). The new information will be included in the next released revision of the manual.

Option	Description and Comments	Installation Method	
DoubleTalk Carrier-in-Carrier	Data rate 18 kbps to 512 kbps	FAST	
	Data rate 18 kbps to 1 Mbps	FAST	
	Data rate 18 kbps to 2.5 Mbps	FAST	
	Data rate 18 kbps to 5.0 Mbps	FAST	
	Data rate 18 kbps to 10.0 Mbps	FAST	
	Data rate 18 kbps to 15.0 Mbps	FAST	
	Data rate 18 kbps to 20.0 Mbps	FAST	
VersaFEC Constant Coding and Modulation (CCM)	Data rate 18 kbps to 25.0 Mbps	FAST	
	Data rate 18 kbps to 1.1 Mbps	FAST	
	Data rate 18 kbps to 2.5 Mbps	FAST	
VersaFEC Adaptive Coding and Modulation (ACM)	Data rate 18 kbps to 5.0 Mbps	FAST	
	Data rate 18 kbps to 16.0 Mbps	FAST	
	Symbol rate 37 ksps to 300 ksps	FAST	
VersaFEC-2 Constant Coding and Modulation (CCM)	Symbol rate 37 ksps to 1200 ksps	FAST	
	Symbol rate 37 ksps to 4100 ksps	FAST	
	Data rate 18 kbps to 5 Mbps	FAST	
	Data rate 18 kbps to 10 Mbps	FAST	
VersaFEC-2 Adaptive Coding and Modulation (ACM)	Data rate 18 kbps to 15 Mbps	FAST	
	Data rate 18 kbps to 20 Mbps	FAST	
	Data rate 18 kbps to 25 Mbps	FAST	
	Symbol rate 37 ksps to 1200 ksps	FAST	
G.703 Clock Extension	Symbol rate 37 ksps to 2000 ksps	FAST	
	Symbol rate 37 ksps to 4100 ksps	FAST	
	Symbol rate 37 ksps to 8000 ksps	FAST	
	Symbol rate 37 ksps to 12500 ksps	FAST	
Carrier ID	G.703 Clock Extension	FAST	
Advanced Network Timing (ANT)	Carrier ID	FAST	
Main Power Supplies	IEEE-1588v2 Precision Timing Protocol (PTP)	FAST	
	100-240 VAC Nominal, 90-264 VAC Maximum	HARDWARE	
BUC Power Supplies	43-60 VDC Nominal, 36-60 VDC Maximum	HARDWARE	
	24V, 100W	HARDWARE	
IP Packet Processor	48V, 150W @ 50° C (180W@ 35° C)	HARDWARE	
	Card	IP Packet Processor daughter card	HARDWARE
		Payload Compression	Data rate up to 5 Mbps or Symbol rate up to 2000 ksps (ACM)
	Data rate up to 10 Mbps or Symbol rate up to 4100 ksps (ACM)		FAST
	Data rate up to 15 Mbps or Symbol rate up to 5000 ksps (ACM)		FAST
	Data rate up to 20 Mbps or Symbol rate up to 12500 ksps (ACM)		FAST
	Data rate up to 25 Mbps or Symbol rate up to 12500 ksps (ACM)		FAST
	Header Compression	Data rate up to 5 Mbps or Symbol rate up to 2000 ksps (ACM)	FAST
		Data rate up to 10 Mbps or Symbol rate up to 4100 ksps (ACM)	FAST
		Data rate up to 15 Mbps or Symbol rate up to 5000 ksps (ACM)	FAST
		Data rate up to 20 Mbps or Symbol rate up to 12500 ksps (ACM)	FAST
	Advanced QoS	Data rate up to 25 Mbps or Symbol rate up to 12500 ksps (ACM)	FAST
		Advanced QoS	FAST
	AES Encryption	Tx Packet Encryption / Rx Packet Decryption	Available as EN model



CDM-625A

**Advanced Satellite Modem (18 kbps – 25 Mbps)
Installation and Operation Manual**
For Firmware Version 1.4.1 or higher

Part Number MN-CDM625A / CD-MN-CDM625A
Revision 4

BLANK PAGE

TABLE OF CONTENTS

TABLE OF CONTENTS	III
TABLES	XXIII
FIGURES	XXIV
PREFACE	XXIX
About this Manual	xxix
Conventions and References	xxix
Patents and Trademarks	xxix
Warnings, Cautions, and Notes	xxix
Recommended Standard Designations	xxx
Safety and Compliance	xxx
Electrical Safety and Compliance	xxx
Grounding	xxx
Electrical Installation	xxxi
Battery xxi	
Fuses xxi	
Operating Environment.....	xxxii
European Union Radio Equipment and Telecommunications Terminal Equipment (R&TTE) Directive (1999/5/EC) and EN 301 489-1.....	xxxii
European Union Electromagnetic Compatibility (EMC) Directive (2004/108/EC).....	xxxii
European Union Low Voltage Directive (LVD) (2006/95/EC)	xxxiii
European Union RoHS Directive (2002/95/EC).....	xxxiii
European Union Telecommunications Terminal Equipment Directive (91/263/EEC)	xxxiii
CE Mark xxxiv	
Product Support	xxxiv
Comtech EF Data Headquarters	xxxiv
Warranty Policy	xxxiv
Limitations of Warranty.....	xxxv
Exclusive Remedies	xxxv
CHAPTER 1. INTRODUCTION	1-1
1.1 Overview	1-1
1.2 Functional Description	1-3

1.3	Features	1-4
1.3.1	Physical Description	1-4
1.3.2	Modem Compatibility	1-4
1.3.3	Verification.....	1-4
1.3.4	Updating Modem Firmware.....	1-4
1.3.5	Standard Data Interfaces	1-5
1.3.6	Optional Hardware and Accessories.....	1-5
1.3.7	Fully Accessible System Topology (FAST).....	1-7
1.3.8	Supporting Hardware and Software.....	1-9
1.3.9	Physical Features.....	1-10
1.3.9.1	Dimensional Envelope	1-10
1.3.9.2	Front Panel Features.....	1-11
1.3.9.3	Rear Panel Features	1-12
1.4	Summary of Specifications	1-13
1.4.1	Modulator.....	1-13
1.4.2	Demodulator	1-16
1.4.3	Data Interfaces	1-22
1.4.4	Automatic Uplink Power Control (AUPC).....	1-22
1.4.5	DoubleTalk [®] Carrier- in-Carrier [®] (CnC).....	1-23
1.4.6	Framing Summary.....	1-24
1.4.7	Data Rate Ranges.....	1-25
1.4.8	VersaFEC Adaptive Coding and Modulation (ACM).....	1-30
1.4.8.1	VersaFEC ACM	1-30
1.4.8.2	VersaFEC-2 ACM.....	1-31
1.4.9	Miscellaneous.....	1-34
1.4.10	Approvals	1-34
CHAPTER 2.	INSTALLATION.....	2-1
2.1	Unpack and Inspect the Shipment	2-1
2.2	Install the Modem Into a Rack Enclosure	2-2
2.2.1	Install the Optional Rear-Mounting Support Brackets Kits	2-4
2.3	Configure the Modem	2-5
2.4	Verify Modem Operation	2-5
2.5	Connect the External Cables.....	2-5
CHAPTER 3.	REAR PANEL CONNECTORS AND PINOUTS	3-1
3.1	Cabling Connection Types	3-1
3.1.1	Coaxial Cable Connections.....	3-1
3.1.1.1	Type 'BNC'	3-2
3.1.1.2	Type 'TNC'	3-2
3.1.1.3	Type 'N'.....	3-2

3.1.1.4	Type 'F'	3-2
3.1.1.5	Type 'SMA' (Subminiature Version 'A').....	3-2
3.1.2	D-Subminiature Cable Connections.....	3-3
3.1.3	RJ-45, RJ-48 Cable Connections.....	3-3
3.2	CDM-625A Cabling Connections	3-4
3.2.1	IF Connection Group.....	3-5
3.2.1.1	Rx IF Connectors	3-5
3.2.1.2	Tx IF Connectors	3-5
3.2.2	Terrestrial Data Connection Group.....	3-6
3.2.2.1	Data Interface (DB-25F).....	3-6
3.2.2.1.1	HSSI Operation via the CIC-60 Interface Adapter Module.....	3-7
3.2.2.2	G.703 Connectors.....	3-9
3.2.2.2.1	Balanced G.703 (DB-9F).....	3-9
3.2.2.2.2	Aux G.703 (DB-9F).....	3-9
3.2.2.2.3	Quad E1 Operation via the Balanced G.703 / Aux G.703 Connectors	3-10
3.2.2.2.3.1	CA-0000163 Adapter Cable.....	3-10
3.2.2.2.3.2	CA-0000164 Adapter Cable.....	3-11
3.2.2.2.3.3	KT-0000122/KT-0020570 Quad E1 Balanced/Unbalanced Adapter Cable Kits	3-12
3.2.2.2.4	Unbal G.703 / ASI – Out (IDO), In (DDI)	3-13
3.2.2.2.5	G.703 IDI (Insert Data In), DDO (Drop Data Out).....	3-13
3.2.2.3	Quad 10/100 Ethernet (RJ-45).....	3-13
3.2.2.4	IDR Data / Alarms / Audio (HD-44F).....	3-13
3.2.2.5	ESC (DB-9F).....	3-14
3.2.3	Utility Connections Group.....	3-14
3.2.3.1	Remote Control (DB-9M)	3-14
3.2.3.2	Alarms (DB-15M).....	3-15
3.2.3.3	PMSI Connector (DB-9F).....	3-15
3.2.3.4	1:1 Control (DB-9F).....	3-16
3.2.3.5	Ext Ref In/Out	3-16
3.3	CDM-625A Ground and Power Connections.....	3-17
3.3.1	Chassis Ground Interface	3-17
3.3.2	Standard 100V/240V Alternating Current (AC) Power Interface	3-18
3.3.2.1	AC Operation – CDM-625A Accessories	3-18
3.3.2.2	AC Operation – Apply Power	3-19
3.3.2.3	AC Operation – Replace the Fuses	3-19
3.3.3	Optional 48V Direct Current (DC) Power Interface.....	3-20
3.3.3.1	Optional DC Operation – CDM-625A Accessories.....	3-21
3.3.3.2	Optional DC Operation – Apply Power	3-21
3.3.3.3	Optional DC Operation – Replace the Fuses	3-22
CHAPTER 4.	UPDATING FIRMWARE	4-1
4.1	Update Firmware via the Internet	4-1
4.2	About Firmware Files, Naming, Versions, and Archive Formats	4-2

4.3	Ethernet FTP Upload Procedure.....	4-3
4.3.1	Getting Started: Prepare for the Firmware Download.....	4-3
4.3.2	Download and Extract the Firmware Update.....	4-7
4.3.3	Perform the Ethernet FTP Upload Procedure	4-9
 CHAPTER 5. FAST ACTIVATION PROCEDURE.....		5-1
5.1	Overview.....	5-1
5.2	FAST Activation Procedure.....	5-2
5.2.1	FAST Activation Using the CDM-625A Front Panel.....	5-2
5.2.2	FAST Activation Using the CDM-625A HTTP (Web Server) Interface	5-4
 CHAPTER 6. FRONT PANEL OPERATION.....		6-1
6.1	Overview.....	6-1
6.1.1	LED Indicators.....	6-2
6.1.2	Keypad.....	6-3
6.1.3	Vacuum Fluorescent Display (VFD).....	6-4
6.1.3.1	Screen Saver.....	6-4
6.1.3.2	Opening Screen	6-4
6.1.3.2.1	Feature Availability/Operation Indicators via the Opening Screen.....	6-4
6.2	SELECT: (Main) Menu.....	6-6
6.2.1	SELECT: CONFIG (Configuration) Menu Branch	6-8
6.2.1.1	CONFIG: All.....	6-9
6.2.1.2	CONFIG: Mode.....	6-10
6.2.1.3	CONFIG: Tx.....	6-12
6.2.1.3.1	CONFIG: Tx → Tx-IF.....	6-12
6.2.1.3.2	CONFIG: Tx → Freq (Frequency).....	6-13
6.2.1.3.3	CONFIG: Tx → Power	6-14
6.2.1.3.3.1	CONFIG: Tx → Power → Mode → AUPC.....	6-14
6.2.1.3.4	CONFIG: Tx → FEC	6-17
6.2.1.3.5	CONFIG: Tx → Mod (Modulation)	6-18
6.2.1.3.6	CONFIG: Tx → Data.....	6-20
6.2.1.3.7	CONFIG: Tx → Symb (IP-ACM or V2-ACM Modes Only).....	6-21
6.2.1.3.8	CONFIG: Tx → Scrambler.....	6-21
6.2.1.4	CONFIG: Rx.....	6-23
6.2.1.4.1	CONFIG: Rx → Rx-IF	6-23
6.2.1.4.2	CONFIG: Rx → Freq (Frequency)	6-24
6.2.1.4.3	CONFIG: Rx → FEC.....	6-25
6.2.1.4.4	CONFIG: Rx → Demod (Demodulation).....	6-26
6.2.1.4.5	CONFIG: Rx → Data	6-27
6.2.1.4.6	CONFIG: Rx → Symb (IP-ACM or V2-ACM Modes Only).....	6-29
6.2.1.4.7	CONFIG: Rx → Descram (Descrambler).....	6-29
6.2.1.4.8	CONFIG: Rx → Eq (Equalizer).....	6-30
6.2.1.4.9	CONFIG: Rx → EbNo	6-30
6.2.1.4.10	CONFIG: Rx → SNR (IP-ACM or V2-ACM Modes Only)	6-30

6.2.1.5	CONFIG: Clocks	6-31
6.2.1.5.1	CONFIG: Clocks → Tx Clock.....	6-31
6.2.1.5.2	CONFIG: Clocks → Rx Buffer/Clock.....	6-32
6.2.1.5.3	CONFIG: Clocks → Clk-Ext (G.703 Clock Extension).....	6-33
6.2.1.5.4	CONFIG: Clocks → Freq-Ref.....	6-34
6.2.1.5.5	CONFIG: Clocks → Int-Ref-Adjust	6-34
6.2.1.6	CONFIG: D&I (Drop & Insert)	6-35
6.2.1.6.1	CONFIG: D&I (D&I, D&I++ One-Port Drop and Insert Framing Mode).....	6-35
6.2.1.6.2	CONFIG: Quad D&I (QDI) (QDI, Framed QDI Framing Mode).....	6-37
6.2.1.7	CONFIG: ACM (Adaptive Coding and Modulation) (IP-ACM or V2-ACM Modes Only).....	6-39
6.2.1.7.1	CONFIG: ACM → Min/Max-ModCod	6-39
6.2.1.7.2	CONFIG: ACM → Unlock-Action	6-40
6.2.1.7.3	CONFIG: ACM → Target-SNR-Margin	6-40
6.2.1.8	CONFIG: CnC	6-41
6.2.1.8.1	CONFIG: CnC → Mode	6-41
6.2.1.8.2	CONFIG: CnC → CONFIG: CnC → Freq-Offset	6-41
6.2.1.8.3	CONFIG: CnC → Search-Delay	6-42
6.2.1.8.4	CONFIG: CnC → PMSI-Control	6-43
6.2.1.9	CONFIG: EDMAC.....	6-44
6.2.1.10	CONFIG: Misc.....	6-45
6.2.1.10.1	CONFIG: Misc → G.703-LineCode (Ternary Code).....	6-45
6.2.1.10.2	CONFIG: Misc → IDR-ESC.....	6-45
6.2.1.10.3	CONFIG: Misc → HSSI	6-46
6.2.1.10.4	CONFIG: Misc → RTS	6-46
6.2.1.10.5	CONFIG: Misc → Audio-Vol (ADPCM Audio Volumes)	6-46
6.2.1.10.6	CONFIG: Misc → HiRateESC.....	6-47
6.2.1.10.7	CONFIG: Misc → Warm-Up.....	6-48
6.2.1.10.8	CONFIG: Misc → Stats (Statistics).....	6-48
6.2.1.10.9	CONFIG: Misc → MEO (Medium Earth Orbit).....	6-48
6.2.1.11	CONFIG: Mask.....	6-50
6.2.1.11.1	CONFIG: Mask → AIS	6-50
6.2.1.11.2	CONFIG: Mask → Buffer/Ref	6-50
6.2.1.11.3	CONFIG: Mask → RxIF.....	6-51
6.2.1.11.4	CONFIG: Mask → TxClk.....	6-51
6.2.1.11.5	CONFIG: Mask → CnC.....	6-51
6.2.1.11.6	CONFIG: Mask → TxSat (Satellite Tx Alarms)	6-52
6.2.1.11.7	CONFIG: Mask → RxSat (Satellite Rx Alarms).....	6-52
6.2.1.11.8	CONFIG: Mask → Terr.....	6-52
6.2.1.11.9	CONFIG: Mask → BUC	6-52
6.2.1.11.10	CONFIG: Mask → LNB.....	6-53
6.2.1.11.11	CONFIG: Mask → ClkExt (G.703 Clock Extension Mask).....	6-53
6.2.1.12	CONFIG: Remote (Remote Control).....	6-54
6.2.1.12.1	CONFIG: Remote → Local or Serial Remote Settings	6-54
6.2.1.13	CONFIG: IP.....	6-55
6.2.1.13.1	CONFIG: IP → Addresses	6-55
6.2.1.13.2	CONFIG: IP → SNMP	6-56
6.2.1.13.3	CONFIG: IP → Setup.....	6-58
6.2.1.13.3.1	CONFIG: IP → IP Setup: Mode	6-58

6.2.1.13.3.2	CONFIG: IP → IP Setup: WAN	6-58
6.2.1.13.3.3	CONFIG: IP → Setup: PerPortCnfg	6-59
6.2.1.13.3.4	CONFIG: IP → IP Setup: DDMgmtPt (Dedicated Management Port)	6-61
6.2.1.13.3.5	CONFIG: IP → IP Setup: MAC-Lrng (MAC Learning).....	6-62
6.2.1.13.3.6	CONFIG: IP → IP Setup: Rad (Remote Authentication Dial In User Service) ...	6-63
6.2.1.13.3.7	CONFIG: IP → IP Setup: VLAN.....	6-63
6.2.1.13.3.8	CONFIG: IP → IP Setup: QoS (Quality of Service)	6-68
6.2.1.13.3.9	CONFIG: IP → IP Setup: Stats.....	6-69
6.2.1.13.3.10	CONFIG: IP → IP Setup: FrmSize.....	6-70
6.2.1.13.4	CONFIG: IP → ANT (Advanced Network Timing)	6-71
6.2.1.13.4.1	CONFIG: IP → ANT → SNTP (Simple Network Time Protocol)	6-71
6.2.1.13.4.2	CONFIG: IP → ANT → PTP (Precision Time Protocol).....	6-72
6.2.1.13.5	CONFIG: IP → PortMonitor.....	6-73
6.2.1.13.6	CONFIG: IP → AccessList.....	6-73
6.2.1.13.7	CONFIG: IP → PktP-Enable	6-74
6.2.2	SELECT: Test Menu Branch	6-75
6.2.2.1	SELECT: TEST → Mode.....	6-75
6.2.2.2	SELECT: TEST → BERT	6-77
6.2.2.2.1	SELECT: TEST → BERT → Config	6-77
6.2.2.2.2	SELECT: TEST → BERT → Monitor	6-77
6.2.2.3	SELECT: TEST → CnC-APC-Monitor	6-77
6.2.2.4	SELECT: TEST → Uncorrected-BER.....	6-78
6.2.3	SELECT: Monitor Menu Branch	6-79
6.2.3.1	Monitor: Live-Alarms	6-79
6.2.3.2	Monitor: Stored Events	6-81
6.2.3.3	Monitor: ACM.....	6-81
6.2.3.4	Monitor: Statistics	6-82
6.2.3.4.1	Monitor: Statistics Examples	6-82
6.2.3.5	Monitor: Rx Parameters.....	6-84
6.2.3.6	Monitor: RemoteEbNo	6-85
6.2.3.7	Monitor: AUPC-Parameters	6-85
6.2.3.8	Monitor: CnC-Parameters	6-86
6.2.3.9	Monitor: IP Statistics.....	6-86
6.2.4	SELECT: Info (Information) Menu Branch	6-87
6.2.4.1	Info: All.....	6-87
6.2.4.2	Info: ID	6-87
6.2.4.3	Info: Mode.....	6-87
6.2.4.4	Info: Tx	6-88
6.2.4.5	Info: Rx.....	6-88
6.2.4.6	Info: Clocks	6-89
6.2.4.7	Info: EDMAC.....	6-89
6.2.4.8	Info: Drop	6-89
6.2.4.9	Info: Insert	6-89
6.2.4.10	Info: Remote	6-90
6.2.4.11	Info: Alarm-Mask.....	6-90
6.2.4.12	Info: Misc.....	6-90
6.2.5	SELECT: Store/Ld (Store/Load) Menu Branch.....	6-91
6.2.6	SELECT: Utility Menu Branch	6-92

6.2.6.1	Utilities: Set-RTC	6-92
6.2.6.2	Utilities: Display-Bright.....	6-92
6.2.6.3	Utilities: CarrID.....	6-93
6.2.6.3.1	Utilities: CarrID → Latitude.....	6-93
6.2.6.3.2	Utilities: CarrID → Longitude.....	6-93
6.2.6.3.3	Utilities: CarrID → Telephone.....	6-94
6.2.6.3.4	Utilities: CarrID → Message.....	6-94
6.2.6.4	Utilities: LED	6-94
6.2.6.5	Utilities: Redundancy	6-95
6.2.6.5.1	Utilities: Redundancy → Traffic-IP-Addr/Range	6-95
6.2.6.5.2	Utilities: Redundancy → 1:1	6-95
6.2.6.5.3	Utilities: Redundancy → 1:N.....	6-95
6.2.6.6	Utilities: Circuit-ID.....	6-96
6.2.6.7	Utilities: Firmware	6-97
6.2.6.7.1	Utilities: Firmware → Base-Modem	6-97
6.2.6.7.1.1	Utilities: Firmware → Base-Modem → Boot-ROM, Image#X	6-97
6.2.6.7.1.2	Utilities: Firmware → Base-Modem →Select.....	6-97
6.2.6.7.2	Utilities: Firmware → Packet-Processor	6-98
6.2.6.7.2.1	Utilities: Firmware → Packet-Processor → Boot-ROM, Image#X	6-98
6.2.6.7.2.2	Utilities: Firmware → Packet-Processor →Select	6-98
6.2.6.8	Utilities: Em (CDM-600/600L Emulation)	6-99
6.2.7	SELECT: ODU Menu Branch (Summary Only).....	6-100
6.2.8	SELECT: FAST Menu Branch.....	6-100
6.2.8.1	FAST: Options.....	6-100
6.2.8.1.1	FAST: Options → View Options	6-100
6.2.8.1.2	FAST: Options → Set Register1 or Set Register 2	6-102
6.2.8.2	FAST: Demo-Mode.....	6-103
6.2.8.3	FAST: CnC	6-104
CHAPTER 7. ETHERNET-BASED REMOTE PRODUCT MANAGEMENT		7-1
7.1	Overview	7-1
7.2	Ethernet Management Interface Protocols	7-1
7.3	SNMP Interface.....	7-2
7.3.1	Management Information Base (MIB) Files.....	7-2
7.3.2	SNMP Community Strings.....	7-3
7.3.3	SNMP Traps	7-3
7.4	Telnet Interface	7-5
7.4.1	Using the Telnet Interface for Standard Remote Control Protocol	7-5
7.4.1.1	Using HyperTerminal for Telnet Remote Control Operation	7-6
7.4.2	Using the Telnet Interface for Telnet Command Line Interface (CLI) Operation.....	7-7
7.5	HTTP (Web Server) Interface	7-8
7.5.1	User Login	7-8
7.5.2	HTTP Interface – Operational Features.....	7-9

7.5.2.1	Navigation	7-9
7.5.2.2	Page Sections	7-9
7.5.2.3	Action Buttons	7-9
7.5.2.4	Drop-down Lists.....	7-10
7.5.2.5	Text or Data Entry.....	7-10
7.5.3	HTTP Interface – Menu Tree.....	7-11
7.5.3.1	Conditional Access to IP Packet Processor Pages	7-12
7.5.4	Web Server Page Descriptions	7-13
7.5.4.1	Home Page	7-13
7.5.4.1.1	Home Contact / Home Support.....	7-14
7.5.4.2	Admin Pages	7-14
7.5.4.2.1	Admin Access	7-14
7.5.4.2.2	Admin SNMP	7-17
7.5.4.2.3	Admin Firmware Pages	7-18
7.5.4.2.3.1	Admin Firmware Base Modem.....	7-18
7.5.4.2.3.2	Admin Firmware Packet Processor.....	7-19
7.5.4.2.4	Admin Reboot	7-20
7.5.4.2.5	Admin FAST	7-21
7.5.4.2.6	Admin Utilities.....	7-22
7.5.4.3	Configuration Pages	7-23
7.5.4.3.1	Configuration Modem.....	7-23
7.5.4.3.2	Configuration LAN Pages.....	7-25
7.5.4.3.2.1	Configuration LAN IP	7-25
7.5.4.3.2.2	Configuration LAN ARP.....	7-29
7.5.4.3.2.3	Configuration LAN Port Monitoring	7-31
7.5.4.3.3	Configuration Routing Pages.....	7-32
7.5.4.3.3.1	Configuration Routing Routes	7-32
7.5.4.3.3.2	Configuration Routing IGMP	7-34
7.5.4.3.3.3	Configuration Routing DHCP	7-36
7.5.4.3.3.4	Configuration Routing DNS	7-37
7.5.4.3.4	Configuration Managed Switch.....	7-38
7.5.4.3.5	Configuration WAN Pages.....	7-40
7.5.4.3.5.1	Configuration WAN QoS Pages.....	7-40
7.5.4.3.5.1.1	Configuration WAN QoS Pages – Max/Priority, Min/Max Modes	7-41
7.5.4.3.5.1.2	Configuration WAN QoS Pages – DiffServ Mode.....	7-45
7.5.4.3.5.2	Configuration WAN Compression	7-47
7.5.4.3.5.3	Configuration WAN Encryption.....	7-48
7.5.4.3.6	Configuration Overhead.....	7-50
7.5.4.3.7	Configuration Utilities pages.....	7-52
7.5.4.3.7.1	Configuration Utilities Utilities1	7-52
7.5.4.3.7.2	Configuration Utilities Carrier ID	7-54
7.5.4.3.8	Configuration D&I (Drop and Insert).....	7-56
7.5.4.3.9	Configuration BUC (Block Up Converter)	7-57
7.5.4.3.10	Configuration LNB (Low Noise Block Down Converter)	7-57
7.5.4.3.11	Configuration ANT (Advanced Network Timing) Pages	7-58
7.5.4.3.11.1	Configuration ANT PTP (Precision Time Protocol)	7-58
7.5.4.3.11.2	Configuration ANT SNTP (Simple Network Timing Protocol)	7-60
7.5.4.3.11.3	Configuration MEO (Medium Earth Orbit).....	7-62

7.5.4.4	Status Pages	7-64
7.5.4.4.1	Status Modem Status	7-64
7.5.4.4.2	Status Modem Logs	7-65
7.5.4.4.2.1	Status Modem Logs Base Modem	7-65
7.5.4.4.2.2	Status Modem Logs Packet Processor	7-67
7.5.4.4.3	Status Modem Info	7-68
7.5.4.4.4	Status Traffic Statistics Pages	7-69
7.5.4.4.4.1	Status Traffic Statistics Ethernet	7-69
7.5.4.4.4.2	Status Traffic Statistics Router	7-70
7.5.4.4.4.3	Status Traffic Statistics Managed Switch	7-71
7.5.4.4.4.4	Status Traffic Statistics WAN	7-72
7.5.4.4.4.5	Status Traffic Statistics Compression	7-73
7.5.4.4.4.6	Status Traffic Statistics QoS	7-74
7.5.4.4.4.7	Status Traffic Statistics PTP	7-75
7.5.4.4.4.8	Status Traffic Statistics MAC Table	7-77
7.5.4.4.4.9	Status Traffic Statistics Clear Counters	7-78
7.5.4.4.5	Status Performance Pages	7-79
7.5.4.4.5.1	Status Performance Performance	7-79
7.5.4.4.5.2	Status Performance Graphs	7-80
7.5.4.5	ODU (Outdoor Unit) Pages (Summary Only)	7-81
7.5.4.6	Redundancy Page	7-82
CHAPTER 8. SERIAL-BASED REMOTE PRODUCT MANAGEMENT		8-1
8.1	Overview	8-1
8.2	EIA-485	8-1
8.3	EIA-232	8-2
8.4	Basic Protocol	8-2
8.4.1	Packet Structure	8-3
8.4.1.1	Start of Packet	8-4
8.4.1.2	Target Address	8-4
8.4.1.3	Address Delimiter	8-4
8.4.1.4	Instruction Code	8-4
8.4.1.5	Instruction Code Qualifier	8-5
8.4.1.6	Optional Message Arguments	8-6
8.4.1.7	End Of Packet	8-6
8.5	Remote Commands and Queries	8-7
8.5.1	Table Indexes	8-7
8.5.2	Tx Parameters	8-10
8.5.3	Rx Parameters	8-19
8.5.4	Unit Parameters	8-27
8.5.5	Bulk Configuration Strings	8-43
8.5.6	Modem Information	8-49
8.5.7	Modem Performance Information	8-53

8.5.8	BUC Parameters (L-Band Device).....	8-59
8.5.9	LNB Parameters (L-Band Device).....	8-61
8.5.10	Ethernet Parameters.....	8-62
CHAPTER 9. TELNET COMMAND LINE INTERFACE (CLI) OPERATION		9-1
9.1	Overview.....	9-1
9.1.1	Interface Access	9-1
9.1.2	Terminal Emulator Considerations	9-2
9.1.2.1	Using the PuTTY Terminal Emulator	9-2
9.1.2.2	Using the Tera Term Terminal Emulator	9-4
9.2	Using the Telnet Command Line Interface (CLI).....	9-7
9.2.1	Telnet CLI Menu System – Parallel Functionality	9-7
9.2.2	CLI Menus – Common Navigation and Operation Features.....	9-7
9.3	Command Line Interface Pages.....	9-10
9.3.1	Home (Main) Menu.....	9-10
9.3.1.1	Home > Remote Access Mode	9-11
9.3.2	Home > Administration Submenu	9-12
9.3.2.1	Home > Administration > Host Access List.....	9-13
9.3.2.2	Home > Administration > SNMP	9-14
9.3.2.3	Home > Administration > Firmware (Base Modem) or (Packet Processor).....	9-15
9.3.2.4	Home > Administration > Reboot.....	9-16
9.3.2.5	Home > Administration > FAST.....	9-17
9.3.2.6	Home > Administration > Save Modem Configuration / Load Modem Configuration.....	9-19
9.3.2.7	Home > Administration > Restore Factory Defaults	9-21
9.3.3	Home > Modem Submenu	9-22
9.3.3.1	Home > Modem > Interface.....	9-23
9.3.3.2	Home > Modem > Modem TX.....	9-24
9.3.3.3	Home > Modem > Modem RX.....	9-26
9.3.3.4	Home > Modem > Carrier-in-Carrier (CnC)	9-28
9.3.3.5	Home > Modem > Adaptive Coding and Modulation (ACM).....	9-29
9.3.3.6	Home > Modem > Drop and Insert (D&I).....	9-30
9.3.3.6.1	Home > Modem > Drop and Insert (D&I) > D&I Tables	9-31
9.3.3.7	Home > Modem > Block Upconverter (BUC).....	9-33
9.3.3.8	Home > Modem > (Low-Noise Block Downconverter) LNB.....	9-34
9.3.3.9	Home > Modem > MEO (Medium-Earth Orbit) (FUTURE).....	9-35
9.3.3.10	Home > Modem > Utilities	9-36
9.3.3.11	Home > Modem > Overhead.....	9-38
9.3.4	Home > Network Submenu	9-40
9.3.4.1	Home > Network > Ethernet Ports.....	9-41
9.3.4.1.1	Home > Network > Ethernet Ports > Ethernet Port #.....	9-42
9.3.4.2	Home > Network > LAN IP.....	9-43
9.3.4.3	Home > Network > LAN ARP.....	9-44
9.3.4.3.1	Home > Network > LAN ARP > Arp Table > Arp Entry #.....	9-45
9.3.4.4	Home > Network > VLAN	9-46
9.3.4.4.1	Home > Network > VLAN > VLAN Table > VLAN #	9-47

- 9.3.4.5 Home > Network > Routes 9-48
 - 9.3.4.5.1 Home > Network > Routes > Route Table..... 9-49
- 9.3.4.6 Home > Network > Managed Switch 9-50
- 9.3.4.7 Home > Network > IGMP (Internet Group Management Protocol) 9-51
- 9.3.4.8 Home > Network > DNS (Domain Name System) 9-52
- 9.3.4.9 Home > Network > DHCP (Dynamic Host Configuration Protocol) 9-52
- 9.3.4.10 Home > Network > PTP (Precision Time Protocol) 9-53
- 9.3.4.11 Home > Network > SNTP (Simple Network Time Protocol) 9-54
- 9.3.4.12 Home > Network > MAC Table 9-55
- 9.3.5 Home > WAN Submenu 9-56
 - 9.3.5.1 Home > WAN > QoS Submenu 9-57
 - 9.3.5.1.1 Home > WAN > QoS > Max-Pri / Min-Max Table 9-58
 - 9.3.5.1.2 Home > WAN > QoS > QoS Differentiated Services Table 9-59
 - 9.3.5.2 Home > WAN > Compression 9-60
 - 9.3.5.3 Home > WAN > Encryption 9-61
- 9.3.6 Home > Outdoor Unit (ODU) Submenus (Summary Only) 9-63
- 9.3.7 Home > Redundancy Submenu 9-64
- 9.3.8 Home > General Information Submenu 9-65
 - 9.3.8.1 Home > General Information > Modem Status 9-66
 - 9.3.8.2 Home > General Information > Modem Information 9-67
 - 9.3.8.3 Home > General Information > MAC Table 9-68
 - 9.3.8.4 Home > General Information > Block Upconverter (BUC) 9-69
 - 9.3.8.5 Home > General Information > Low Noise Block Downconverter (LNB) 9-69
- 9.3.9 Home > Logs Submenu 9-70
 - 9.3.9.1 Home > Logs > Base Modem 9-71
 - 9.3.9.1.1 Home > Logs > Base Modem > Stored Event Table 9-72
 - 9.3.9.1.2 Home > Logs > Base Modem > Stored Statistic Table 9-73
 - 9.3.9.2 Home > Logs > Packet Processor 9-74
 - 9.3.9.2.1 Home > Logs > Packet Processor > Stored Event Table 9-75
- 9.3.10 Home > Statistics Submenu 9-76
 - 9.3.10.1 Home > Statistics > Ethernet Submenu 9-77
 - 9.3.10.1.1 Home > Statistics > Ethernet > Rx 9-78
 - 9.3.10.1.2 Home > Statistics > Ethernet > Tx 9-79
 - 9.3.10.1.3 Home > Statistics > Ethernet > Errors 9-80
 - 9.3.10.2 Home > Statistics > Router 9-81
 - 9.3.10.3 Home > Statistics > Managed Switch 9-82
 - 9.3.10.4 Home > Statistics > WAN (Router Mode) 9-83
 - 9.3.10.5 Home > Statistics > WAN (Managed Switch Mode) 9-84
 - 9.3.10.6 Home > Statistics > Compression 9-85
 - 9.3.10.6.1 Home > Statistics > Compression > Table View 9-86
 - 9.3.10.7 Home > Statistics > QoS 9-87
 - 9.3.10.7.1 Home > Statistics > QoS > Table View 9-87
 - 9.3.10.8 Home > Statistics > PTP 9-88
 - 9.3.10.8.1 Home > Statistics > PTP > LAN Details 9-89
 - 9.3.10.8.2 Home > Statistics > PTP > WAN Details 9-89
 - 9.3.10.9 Home > Statistics > CPU 9-90
 - 9.3.10.10 Home > Statistics > Clear All Counters 9-90
- 9.3.11 Home > Contact Page 9-90

- CHAPTER 10. CDM-625A ODU (TRANSCEIVER, BUC, LNB) OPERATION10-1**
- 10.1 Overview10-1**
- 10.2 ODU Remote Control Address Setup.....10-2**
- 10.3 ODU Operations via the CDM-625A Front Panel.....10-3**
 - 10.3.1 CDM-625A Front Panel Operation Overview10-3
 - 10.3.2 CDM-625A Front Panel Menus – ODU Menu Hierarchy.....10-4
 - 10.3.3 SELECT: (Main) Menu Overview.....10-5
 - 10.3.3.1 (SELECT: CONFIGURATION) Menu Branches10-6
 - 10.3.3.1.1 CONFIG: Tx → Freq and CONFIG: Rx → Freq Submenus.....10-6
 - 10.3.3.1.2 (SELECT: CONFIGURATION) Mask Submenus10-6
 - 10.3.3.1.2.1 CONFIG: Mask → BUC10-7
 - 10.3.3.1.2.2 CONFIG: Mask → LNB.....10-8
 - 10.3.3.2 (SELECT: MONITOR) Live-Alarms Menu10-9
 - 10.3.3.3 (SELECT:) ODU Menu Branches10-10
 - 10.3.3.3.1 ODU: BUC:PwrSupply+Ref (Power Supply and Reference).....10-10
 - 10.3.3.3.1.1 ODU: BUC:PwrSupply+Ref → PSU-and-10MHz Parameters.....10-10
 - 10.3.3.3.1.2 ODU: BUC:PwrSupply+Ref → LO Freq (Local Oscillator Frequency)10-11
 - 10.3.3.3.1.3 ODU: BUC:PwrSupply+Ref → PSUmonitor10-11
 - 10.3.3.3.2 ODU: LNB:PwrSupply+Ref (Power Supply and Reference).....10-12
 - 10.3.3.3.2.1 ODU: LNB:PwrSupply+Ref → PSU-and-10MHz.....10-12
 - 10.3.3.3.2.2 ODU: LNB:PwrSupply+Ref → LO-Freq (Local Oscillator Frequency)10-12
 - 10.3.3.3.2.3 ODU: LNB:PwrSupply+Ref → PSUmonitor10-13
 - 10.3.3.3.3 ODU: FSK-control10-13
 - 10.3.3.3.3.1 ODU: FSK-control → CSAT10-15
 - 10.3.3.3.3.1.1 ODU: FSK-control → CSAT (2CSATs → CSAT #X) → Configuration10-15
 - 10.3.3.3.3.1.1.1 ODU: FSK-control → CSAT (2CSATs → CSAT #X) → Configuration → Tx..10-15
 - 10.3.3.3.3.1.1.2 ODU: FSK-control → CSAT (2CSATs → CSAT #X) → Configuration → Rx..10-16
 - 10.3.3.3.3.1.1.3 ODU: FSK-control → CSAT (2CSATs → CSAT #X) → Configuration → LNA10-16
 - 10.3.3.3.3.1.1.4 ODU: FSK-control → CSAT (2CSATs → CSAT #X) → Configuration →..... Misc.....10-17
 - 10.3.3.3.3.1.2 ODU: FSK-control → CSAT (2CSATs → CSAT #X) → Monitor10-17
 - 10.3.3.3.3.1.3 ODU: FSK-control → CSAT (2CSATs → CSAT #X) → Alarms10-18
 - 10.3.3.3.3.1.3.1 ODU: FSK-control → CSAT (2CSATs → CSAT #X) → Alarms →Current-Alarms10-18
 - 10.3.3.3.3.1.3.2 ODU: FSK-control → CSAT (2CSATs → CSAT #X) → Alarms → Stored-Alarms10-19
 - 10.3.3.3.3.1.4 ODU: FSK-control → CSAT (2CSATs → CSAT #X) → Info10-19
 - 10.3.3.3.3.2 ODU: FSK-control → 2CSATs.....10-21
 - 10.3.3.3.3.2.1 ODU: FSK-control → 2CSATs → CSAT#X.....10-21
 - 10.3.3.3.3.2.2 ODU: FSK-control → 2CSATs → Redundancy-Box.....10-21
 - 10.3.3.3.3.3 ODU: FSK-control → KST.....10-22
 - 10.3.3.3.3.3.1 ODU: FSK-control → KST → Configuration.....10-22

10.3.3.3.3.1.1	ODU: FSK-control → KST → Configuration → Tx	10-22
10.3.3.3.3.1.2	ODU: FSK-control → KST → Configuration → Rx	10-22
10.3.3.3.3.1.3	ODU: FSK-control → KST → Configuration → Miscellaneous	10-23
10.3.3.3.3.1.4	ODU: FSK-control → KST → Information	10-23
10.3.3.3.3.1.5	ODU: FSK-control → KST → Information → Model	10-23
10.3.3.3.3.1.6	ODU: FSK-control → KST → Information → Tx+Rx-Param	10-24
10.3.3.3.3.1.7	ODU: FSK-control → KST → Information → Misc	10-24
10.3.3.3.3.1.8	ODU: FSK-control → KST → Information → Numbers	10-24
10.3.3.3.3.1.9	ODU: FSK-control → KST → Alarms	10-24
10.3.3.3.3.4	ODU: FSK-control → BUC	10-25
10.3.3.3.3.4.1	ODU: FSK-control → BUC → Configuration	10-25
10.3.3.3.3.4.2	ODU: FSK-control → BUC → Status	10-25
10.3.3.3.3.4.3	ODU: FSK-control → BUC → Advanced-FSK	10-26
10.3.3.3.3.4.3.1	ODU: FSK-control → BUC → Advanced-FSK → LPOD (2LPODs → Online/Offline LPOD)	10-26
10.3.3.3.3.4.3.1.1	ODU: FSK-control → BUC → Advanced-FSK → LPOD (2LPODs → Online/Offline LPOD) → Cnfg	10-26
10.3.3.3.3.4.3.1.2	ODU: FSK-control → BUC → Advanced-FSK → LPOD (2LPODs → Online/Offline LPOD) → Monitor	10-28
10.3.3.3.3.4.3.1.3	ODU: FSK-control → BUC → Advanced-FSK → LPOD (2LPODs → Online/Offline LPOD) → LPOD → Alarms	10-29
10.3.3.3.3.4.3.1.4	ODU: FSK-control → BUC → Advanced-FSK → LPOD (2LPODs → Online/Offline LPOD) → Statistics	10-30
10.3.3.3.3.4.3.1.5	ODU: FSK-control → BUC → Advanced-FSK → LPOD (2LPODs → Online/Offline LPOD) → Information	10-32
10.3.3.3.3.4.3.1.6	ODU: FSK-control → BUC → Advanced-FSK → LPOD (2LPODs → Online/Offline LPOD) → Redun	10-33
	ODU: FSK-control → BUC → Advanced-FSK → 2LPODs	10-34
10.4	ODU Operations via the CDM-625A HTTP (Web Server) Interface	10-35
10.4.1	Web Server Interface and Menu Tree	10-35
10.4.2	Web Page Descriptions	10-37
10.4.2.1	Configuration BUC (Block Up Converter) Page	10-37
10.4.2.2	Configuration LNB (Low Noise Block Down Converter)	10-38
10.4.2.3	Status Modem Logs Base Modem Page	10-39
10.4.2.4	ODU Pages	10-41
10.4.2.4.1	ODU Enable	10-42
10.4.2.4.2	ODU Config Pages	10-43
10.4.2.4.2.1	ODU Config (CSAT-5060)	10-43
10.4.2.4.2.2	ODU Config (KST-2000A/B)	10-46
10.4.2.4.3	ODU Status	10-48
10.4.2.4.3.1	ODU Status (CSAT-5060)	10-48
10.4.2.4.3.2	ODU Status (KST-2000A/B)	10-49
10.4.2.4.4	ODU Utilities	10-50
10.4.2.4.4.1	ODU Utilities (CSAT-5060)	10-50
10.4.2.4.4.2	ODU Utilities (KST-2000A/B)	10-52

10.5	ODU Operations via the CDM-625A Telnet Command Line Interface (CLI)	10-53
10.5.1	ODU Operations using the Telnet CLI	10-54
10.5.1.1	Home (Main) Menu	10-54
10.5.1.2	Home > Outdoor Unit (ODU) Submenu	10-55
10.5.1.2.1	Home > Outdoor Unit (ODU) > CSAT-5060 Submenu	10-56
10.5.1.2.1.1	Home > Outdoor Unit (ODU) > CSAT-5060 > Up Converter Settings 1/2, 2/2	10-57
10.5.1.2.1.2	Home > Outdoor Unit (ODU) > CSAT-5060 > Down Converter Settings 1/2, 2/2	10-58
10.5.1.2.1.3	Home > Outdoor Unit (ODU) > CSAT-5060 > Unit Settings 1/2, 2/2	10-59
10.5.1.2.1.4	Home > Outdoor Unit (ODU) > CSAT-5060 > LNA Settings	10-60
10.5.1.2.1.5	Home > Outdoor Unit (ODU) > CSAT-5060 > Status	10-61
10.5.1.2.1.6	Home > Outdoor Unit (ODU) > CSAT-5060 > Logs	10-62
10.5.1.2.1.7	Home > Outdoor Unit (ODU) > CSAT-5060 > Redundancy	10-63
10.5.1.2.1.8	Home > Outdoor Unit (ODU) > CSAT-5060 > Utilities	10-63

APPENDIX A. CABLE DRAWINGS.....A-1

A.1	Overview	A-1
A.1.1	EIA-530 to EIA-422/449 DCE Conversion Cable	A-2
A.1.2	EIA-530 to V.35 DCE Conversion Cable	A-3
A.1.3	EIA-232 Remote Control Cable	A-4

APPENDIX B. FEC (FORWARD ERROR CORRECTION) OPTIONS B-1

B.1	FEC Overview	B-1
B.2	Viterbi	B-2
B.3	Sequential	B-3
B.4	Reed-Solomon Outer Codec	B-4
B.4.1	Closed Network Modes	B-4
B.4.2	Open Network Modes	B-4
B.5	Trellis Coding (FAST Option)	B-6
B.6	Turbo Product Codec (Hardware Option)	B-7
B.7	TPC and Low Density Parity Check (LDPC) Coding	B-8
B.7.1	Overview	B-8
B.7.2	TPC vs. LDPC	B-9
B.7.3	End-to-End Processing Delay	B-12
B.8.1	VersaFEC Extensions	B-15
B.8.1.1	Extended CCM Codes	B-15
B.8.1.2	Ultra-Low-Latency (ULL) Codes	B-15

B.9	VersaFEC-2 ACM and CCM	B-16
B.9.1	VersaFEC-2 ACM Latency.....	B-19
B.10	Uncoded Operation (No FEC)	B-20
APPENDIX C. AUPC (AUTOMATIC UPLINK POWER CONTROL)		C-1
C.1	AUPC Overview	C-1
C.2	Setting AUPC Parameters	C-2
C.2.1	Target Eb/No	C-2
C.2.2	Max Range	C-2
C.2.3	Alarm	C-3
C.2.4	Demod Unlock.....	C-3
C.3	Compensation Rate	C-3
C.4	Monitoring	C-4
APPENDIX D. CARRIER ID (DVB-CID METACARRIER®)		D-1
D.1	Overview	D-1
D.2	About MetaCarrier	D-1
D.3	Functional Description	D-2
D.4	Configuring the CDM-625A for Carrier ID Operation	D-3
D.4.1	Enabling Carrier ID Operation.....	D-3
D.4.1.1	Enabling Operation via the CDM-625A Front Panel and VFD	D-3
APPENDIX E. CLOCK MODES AND DROP AND INSERT (D&I)		E-1
E.1	Overview	E-1
E.2	Transmit Clocking	E-1
E.2.1	Internal Clock.....	E-1
E.2.2	TX Terrestrial.....	E-2
E.2.3	RX Loop-Timed, RX=TX	E-2
E.2.4	RX Loop-Timed, RX<>TX (Asymmetric Loop Timing)	E-2
E.2.5	External TT with ST = RX Satellite	E-2
E.3	Receive Clocking	E-4
E.3.1	Buffer Disabled (RX Satellite).....	E-4
E.3.2	Buffer Enabled, TX=RX (TX Terrestrial or Int (SCT) Clock).....	E-4
E.3.3	Buffer Enabled, RX<>TX (TX Terrestrial or Int (SCT) Clock).....	E-4
E.4	X.21 Notes	E-6

E.5	Drop and Insert	E-6
E.6	Frame Formats	E-7
E.7	Timeslot Selection	E-8
E.8	Drop and Insert (D&I) Clocking	E-9
E.9	RX Buffer Clock = Insert (D&I only)	E-10
E.10	Single-Source Multiple Modems	E-10
E.11	G.703 Clock Extension	E-11
E.11.1	Clock Extension Mode 1	E-11
E.11.2	Clock Extension Mode 2	E-12
E.11.3	Clock Extension Mode 3	E-12
E.12	Quad E1 Operation	E-16
 APPENDIX F. DOUBLETALK CARRIER-IN-CARRIER OPTION		 F-1
F.1	Overview	F-1
F.1.1	What is DoubleTalk Carrier-in-Carrier?	F-1
F.1.2	Application Requirements	F-2
F.1.3	Operational Recommendations	F-4
F.2	System Functionality and Operational Considerations	F-5
F.2.1	DoubleTalk Carrier-in-Carrier Cancellation Process	F-7
F.2.2	Margin Requirements	F-9
F.2.4	Carrier-in-Carrier and Adaptive Coding and Modulation	F-9
F.2.5	Carrier-in-Carrier Link Design.....	F-9
F.2.5.1	Symmetric Data Rate Link	F-10
F.2.5.2	Asymmetric Data Rate Link	F-12
F.2.5.3	Power Limited Links	F-13
F.2.6	Carrier-in-Carrier Commissioning and Deployment	F-15
F.2.7	Validate Carrier-in-Carrier Performance	F-16
F.3	Operational References	F-17
F.3.1	Calculate Carrier-in-Carrier Link Budget	F-17
F.3.2	Methods to Estimate PSD Ration	F-18
F.3.2.1	Use Downlink EIRP and Symbol Rate	F-18
F.3.2.2	Use LST.....	F-18
F.3.2.3	Use Satmaster.....	F-19
F.4	Carrier-in-Carrier Automatic Power Control (CnC-APC)	F-20
F.4.1	Overview	F-20
F.4.2	AUPC and Carrier-in-Carrier in the CDM-625A.....	F-20
F.4.3	The CnC Automatic Power Control Algorithm.....	F-20
F.4.4	CnC-APC Framing	F-23

F.4.4.1	CnC-APC Framing and the Self-Locking Problem.....	F-24
F.4.5	CnC-APC Response Time	F-24
F.4.6	CnC-APC Setup	F-24
F.4.7	CnC-APC Redundancy Support Notes	F-27
F.5	DoubleTalk Carrier-in-Carrier Specifications.....	F-28
F.6	Carrier-in-Carrier Summary	F-29
F.7	Glossary.....	F-29
APPENDIX G. E_b/N_0 MEASUREMENT		G-1
APPENDIX H. EDMAC CHANNEL		H-1
H.1	Overview	H-1
H.1.1	EDMAC	H-1
H.1.2	Drop & Insert ++	H-2
H.1.3	EDMAC-3.....	H-2
H.2	M&C Connection.....	H-2
H.3	Setup Summary	H-4
APPENDIX J. ESC++.....		J-1
J.1	Overview	J-1
J.2	Overhead Details	J-1
J.3	Available Baud Rates.....	J-2
J.4	Configuration.....	J-2
J.5	Effect on E_b/N_0 Performance.....	J-2
APPENDIX K. ETHERNET NETWORK CONFIGURATION		K-1
K.1	Overview	K-1
K.2	CDM-625A Ethernet Overview.....	K-1
K.2.1	Interface Architecture	K-1
K.2.2	Modes of Ethernet Operation	K-2
K.2.3	Ethernet Networking Loops.....	K-2
K.2.3.1	Networking Loops in Managed Switch Mode.....	K-3
K.2.3.1.1	Hub-to-Hub Using Ethernet Switches	K-3
K.2.3.1.2	Hub-to-Hub Using Ethernet Routers.....	K-4
K.2.3.1.3	Hub-to-Remotes Using Ethernet Switches or Routers	K-5

- K.2.3.2 Networking Loops in Router Mode (with IP Packet Processor) K-6
- K.3 Ethernet Network Configurations in Managed Switch Mode K-7**
 - K.3.1 Point-to-Multipoint Hub-to-Remotes, Split-path Traffic Using Routers K-7
 - K.3.2 Point-to-Multipoint Hub-to-Remotes, Split-path Traffic Using Switches K-8
- K.4 Ethernet Network Configurations in Router Mode (with IP Packet Processor) K-9**
 - K.4.1 Point-to-Multipoint (Router Multipoint Hub) Mode K-9
 - K.4.1.1 Router Multipoint Hub Configuration K-10
 - K.4.2 Multicast Routing Mode K-11
 - K.4.2.1 Multicast Routing Configuration K-12
- K.5 Ethernet Overhead over WAN Interface K-13**
 - K.5.1 Managed Switch Mode (without IP Packet Processor) K-13
 - K.5.2 Router Mode or Managed Switch Mode (with IP Packet Processor) K-13
- K.6 Ethernet Redundancy K-14**
- K.7 Advanced Network Timing K-15**
 - K.7.1 Overview K-15
 - K.7.2 SNTP (Simple Network Time Protocol) K-15
 - K.7.3 PTP (Precision Time Protocol) K-15
- APPENDIX L. IP PACKET PROCESSOR OPTION L-1**
 - L.1 Overview L-1**
 - L.1.1 Operational Requirements L-1
 - L.1.2 CDM-625A → CDM-625A Interoperability Compatibility/Limitations L-2
 - L.2 IP Packet Processor Features L-2**
 - L.2.1 Streamline Encapsulation (SLE) L-2
 - L.2.2 Modes of Operation L-2
 - L.2.3 Adaptive Coding and Modulation (ACM) L-2
 - L.2.4 Subsystem Multiplex (Sub-Mux) L-2
 - L.2.5 FAST Options L-3
 - L.2.5.1 Advanced Quality of Service (QoS) L-3
 - L.2.5.2 Advanced Encryption Standard (AES) Encryption L-4
 - L.2.5.3 Header Compression L-4
 - L.2.5.4 Payload Compression L-4
 - L.3 CDM-625A Operation with IP Packet Processor L-5**
 - L.3.1 Front Panel Operation L-5
 - L.3.2 Ethernet-based Remote Product Management L-5
 - L.3.2.1 SNMP Interface L-5
 - L.3.2.2 Telnet Interface L-6
 - L.3.2.3 HTTP (Web Server) Interface L-6
 - L.4 List of Supported Internet RFCs (Requests for Comment) L-7**

L.5 IP Packet Processor Field Upgrade Procedure L-8
L.5.1 Overview L-8
L.5.2 Requirements for Field Upgrade..... L-8
L.5.3 Field Upgrade Procedure L-9

**APPENDIX M. VERSAFEC / VERSAFEC-2 ACM (ADAPTIVE CODING AND MODULATION)
OPTION M-1**

M.1 Overview M-1
M.2 Background M-2
M.3 Requirements for ACM..... M-3
M.4 An Existing Satellite ACM Scheme..... M-5
M.5 Disadvantages of DVB-S2 M-5
M.6 VersaFEC ACM M-6
M.6.1 VersaFEC ACM Latency M-8
M.6.2 Configuring VersaFEC ACM in the CDM-625A..... M-9
M.7 VersaFEC-2 ACM M-12
M.7.1 VersaFEC-2 ACM latency..... M-15
M.7.2 Configuring VersaFEC-2 ACM in the CDM-625A M-16
M.8 Monitoring ACM Performance..... M-18
M.9 ACM Congestion Control M-18
M.10 Using ACM with AUPC M-19
M.11 Notes and Recommendations M-20
M.12 Summary of Specifications..... M-22
M.12.1 VersaFEC ACM..... M-22
M.12.2 VersaFEC-2 ACM M-23
M.13 Field Upgrade Procedure – VersaFEC-2 Option Card M-25
M.13.1 Overview M-25
M.13.2 Requirements for Field Upgrade..... M-25
M.13.3 Field Upgrade Procedure M-26

APPENDIX N. IP SUB-MUX..... N-1

N.1 Overview N-1
N.2 Available Ratios N-1

N.3 Data Rate vs. Composite Rate..... N-2

APPENDIX P. OPEN NETWORK OPERATIONS P-1

P.1 Overview..... P-1

P.2 IBS..... P-1

P.2.1 IBS Clock/Data Recovery and De-jitter P-2

P.2.2 IBS Framing..... P-2

P.2.3 IBS Engineering Service Channel P-2

P.2.4 IBS Scrambling..... P-2

P.3 Drop and Insert (D&I)..... P-3

P.3.1 D&I Primary Data Interfaces..... P-4

P.3.2 D&I Framing..... P-4

P.4 IDR P-5

P.4.1 IDR Primary Data Interfaces..... P-6

P.4.2 IDR Engineering Service Channel P-6

APPENDIX Q. OFFSET QPSK OPERATION Q-1

APPENDIX R. QUALITY OF SERVICE (QOS) R-1

R.1 Overview..... R-1

R.1.1 QoS Terminology..... R-1

R.2 Layer 2 QoS..... R-2

R.2.1 Modem Tx Data Rate vs. QoS Tx Data Rate R-2

R.2.2 Flow Control R-3

R.2.3 Port-based Layer 2 QoS..... R-3

R.2.4 VLAN-based Layer 2 QoS..... R-5

R.3 Layer 3 QoS..... R-8

R.3.1 Layer 3 QoS Max-Pri Mode..... R-8

R.3.2 Layer 3 QoS Min-Max Mode..... R-10

R.3.3 Layer 3 QoS DiffServ Mode..... R-12

R.3.3.1 Layer 3 QoS Congestion Avoidance..... R-12

R.3.3.2 Layer 3 QoS List of Supported RFCs (Requests for Comment)..... R-13

R.4 QoS with ACM (Adaptive Coding and Modulation) R-14

R.4.1 Maximum Clipping..... R-14

R.4.2 Minimum Data Rate R-14

APPENDIX S. TRANSMIT SPECTRUM FILTERING OPTIONS S-1

S.1 Overview..... S-1

S.2 Observations and Recommendations S-1

APPENDIX T. CDM-625A RADIUS CLIENT T-1

T.1 Overview T-1

 T.1.1 RADIUS List of Supported RFCs (Requests for Comment)..... T-1

T.2 Service Types T-2

T.3 RADIUS Client T-2

T.4 RADIUS Operation and Configuration T-4

 T.4.1 RADIUS Operation Using the CDM-625A Front Panel T-6

 T.4.2 RADIUS M&C Using the CDM-625A HTTP (Web Server) Interface T-7

 T.4.3 RADIUS M&C Using Telnet..... T-8

APPENDIX U. CDM-625A FTP MODEM-TO-MODEM CONFIGURATION U-1

U.1 Overview U-1

U.2 Perform the FTP Modem Configuration Procedure..... U-2

 U.2.1 Create the Modem Configuration File From the Source Modem..... U-2

 U.2.2 Use the Modem Configuration File to Configure a Target Modem U-3

TABLES

Table 1-1. CDM-625A Optional Hardware and Accessories 1-6

Table 1-2. CDM-625A FAST and FAST-accessible Hardware Options 1-7

Table 1-3. The VersaFEC-2 ModCod Set – Long Block 1-32

Table 1-4. The VersaFEC-2 ModCod Set – Short Block 1-33

Table 3-1. Data Interface Connector Pinouts..... 3-6

Table 3-2. CIC-60 Module Connector Pinouts – HSSI/EIA-613 Side 3-8

Table 3-3. Balanced G.703 Connector Pinouts..... 3-9

Table 3-4. Auxiliary G.703 Connector Pinouts 3-9

Table 3-5. CA-0000163 Connector Pinouts 3-10

Table 3-6. CA-0000164 Connector Pinouts 3-11

Table 3-7. CA-0000347/CA-0020710 Connector Pinouts..... 3-12

Table 3-8. IDR Data/Alarms/Audio Connector Pinouts..... 3-13

Table 3-9. ESC Connector Pinouts..... 3-14

Table 3-10. Remote Control Connector Pinouts 3-14

Table 3-11. Alarm Interface Connector Pinouts..... 3-15

Table 3-12. PMSI (Pre-Mapped Symbol Interface) Connector Pinouts..... 3-15

Table 3-13. 1:1 Control Interface Connector Pinouts 3-16

Table B-1. Viterbi Decoding Summary B-2

Table B-2. Sequential Decoding Summary B-3

Table B-3. Concatenated RS Coding Summary B-5

Table B-4. 8-PSK/TCM Coding Summary.....	B-6
Table B-5. Available TPC/LDPC Modes.....	B-10
Table B-6. Comparison of all Comtech EF Data TPC/LDPC Modes (CDM-625A with TPC/LDPC Codec). ..	B-11
Table B-7. TPC/LDPC Processing Delay Comparison.....	B-12
Table B-8. TPC/LDPC Summary.....	B-12
Table B-9. The VersaFEC ModCod set.....	B-13
Table B-10. The VersaFEC-2 ModCod Set – Long Block.....	B-17
Table B-11. The VersaFEC-2 ModCod Set – Short Block.....	B-18
Table B-12. VersaFEC-2 End-to-End Latency @ 100 ksps.....	B-19
Table F-1. Spectral Efficiency using DoubleTalk Carrier-in-Carrier.....	F-7
Table M-1. The VersaFEC ModCod set.....	M-7
Table M-2. VersaFEC Implementation of ACM – 100 ksymbols/sec Example Case.....	M-8
Table M-3. The VersaFEC-2 ModCod Set – Long Block.....	M-13
Table M-4. The VersaFEC-2 ModCod Set – Short Block.....	M-14
Table M-5. VersaFEC-2 End-to-End Latency @ 100 ksps.....	M-15
Table R-1. Modem Tx Data Rate vs. QoS Tx Data Rate (Hardware-limited).....	R-2
Table R-2. 802.1q to Layer 2 QoS Priority Conversion.....	R-5

FIGURES

Figure 1-1. CDM-625A Advanced Satellite Modem.....	1-1
Figure 1-2. CDM-625A Dimensional Envelope.....	1-10
Figure 1-3. CDM-625A Front Panel Features.....	1-11
Figure 1-4. CDM-625A Rear Panel View.....	1-12
Figure 1-5. Rx Carrier Level vs. Symbol Rate – L-Band (950-2250 MHz).....	1-21
Figure 1-6. Rx Carrier Level vs. Symbol Rate – IF Band (50-180 MHz).....	1-21
Figure 2-1. Unpack and Inspect the Shipment.....	2-1
Figure 2-2. Install the modem into a Rack Enclosure.....	2-3
Figure 2-3. Install the Optional Rear-Mounting Support Brackets Kit.....	2-4
Figure 3-1. Coaxial Connector Examples.....	3-1
Figure 3-2. D-Subminiature Connector Examples.....	3-3
Figure 3-3. CDM-625A Rear Panel View.....	3-4
Figure 3-4. CIC-60 Interface Adapter Module (CEFD P/N PL-0000307).....	3-7
Figure 3-5. CA-0000163 Adapter Cable (DB-9M → (2X) DB-15F).....	3-10
Figure 3-6. CA-0000164 Adapter Cable (DB-9M → (2X) RJ-48F).....	3-11
Figure 3-7. Quad E1 Balanced/Unbalanced Adapter Cable Kits.....	3-12
Figure 3-8. CDM-625A Chassis Ground Interface.....	3-17
Figure 3-9. CDM-625A Standard AC Chassis (CEFD P/N PL/12587-1).....	3-18
Figure 3-10. Apply AC Power to the CDM-625A.....	3-19
Figure 3-11. Replace the CDM-625A AC Fuses.....	3-19
Figure 3-12. CDM-625A Optional DC Chassis (CEFD P/N PL-0021327).....	3-20
Figure 3-13. Apply Power to the CDM-625A Optional DC Chassis.....	3-21
Figure 3-14. Replace the CDM-625A Optional DC Chassis Fuses.....	3-22
Figure 5-1. CDM-625A HTTP Interface – ‘Admin FAST’ page.....	5-4
Figure 6-1. CDM-625A Front Panel Features.....	6-1
Figure 6-2. CDM-625A Principle Menu Tree (FW Ver. 1.4.1).....	6-7
Figure 6-3. Loopback Modes.....	6-76

Figure 7-1. CDM-625A Telnet Command Line Interface (CLI)..... 7-7

Figure 7-2. CDM-625A HTTP (Web Server) Interface Menu Tree (FW Ver. 1.4.1)..... 7-11

Figure 7-3. CDM-625A Satellite Modem Home page..... 7-13

Figure 7-4. Admin | Access page 7-14

Figure 7-5. Admin | SNMP page 7-17

Figure 7-6. Admin | Firmware | Base Modem page..... 7-18

Figure 7-7. Admin | Firmware | Packet Processor page..... 7-19

Figure 7-8. Status | Firmware Info | Reboot page..... 7-20

Figure 7-9. Admin | FAST page 7-21

Figure 7-10. Admin | Utilities page..... 7-22

Figure 7-11. Configuration | Modem page (Non-ACM Modes)..... 7-23

Figure 7-12. Configuration | Modem page (ACM Modes)..... 7-24

Figure 7-13. Configuration | LAN | IP page 7-25

Figure 7-14. Configuration | LAN | ARP page 7-29

Figure 7-15. Configuration | LAN | Port Monitoring Page 7-31

Figure 7-16. Configuration | Routing | Routes page 7-32

Figure 7-17. Configuration | Routing | IGMP page 7-34

Figure 7-18. Configuration | Routing | DHCP page 7-36

Figure 7-19. Configuration | Routing | DNS page..... 7-37

Figure 7-20. Configuration | Managed Switch page..... 7-38

Figure 7-21. Configuration | WAN | QoS Pages 7-41

Figure 7-22. Configuration | WAN | QoS page (DiffServ Mode) 7-45

Figure 7-23. Configuration | WAN | Compression page 7-47

Figure 7-24. Configuration | WAN | Encryption page 7-48

Figure 7-25. Configuration | Overhead page..... 7-50

Figure 7-26. Configuration | Utilities | Utilities1 page 7-52

Figure 7-27. Configuration | Utilities | Carrier ID page 7-54

Figure 7-28. Configuration | D&I page (Selected Framing Mode = D&I)..... 7-56

Figure 7-29. Configuration | BUC page..... 7-57

Figure 7-30. Configuration | LNB page 7-57

Figure 7-31. Configuration | ANT | PTP page 7-58

Figure 7-32. Configuration | ANT | SNTP page..... 7-60

Figure 7-33. Configuration | MEO page..... 7-62

Figure 7-34. Status | Modem Status page (IP-ACM or V2-ACM Mode Active)..... 7-64

Figure 7-35. Status | Modem Logs | Base Modem page 7-65

Figure 7-36. Status | Modem Logs | Packet Processor page..... 7-67

Figure 7-37. Status | Modem Info page..... 7-68

Figure 7-38. Status | Traffic Statistics | Ethernet page 7-69

Figure 7-39. Status | Traffic Statistics | Router page..... 7-70

Figure 7-40. Status | Traffic Statistics | Managed Switch page..... 7-71

Figure 7-41. Status | Traffic Statistics | WAN page 7-72

Figure 7-42. Status | Traffic Statistics | Compression page 7-73

Figure 7-43. Status | Traffic Statistics | QoS page (DiffServ Mode shown)..... 7-74

Figure 7-44. Status | Traffic Statistics | PTP page..... 7-75

Figure 7-45. Status | Traffic Statistics | MAC Table page 7-77

Figure 7-46. Status | Traffic Statistics | Clear Counters page..... 7-78

Figure 7-47. Status | Performance | Performance page 7-79

Figure 7-48. Status | Performance | Graphs page..... 7-80

Figure 7-49. ODU Page Examples (Enable, Config, Status, and Utilities)..... 7–81

Figure 7-50. Redundancy page 7–82

Figure 10-1. CDM-625A Front Panel Features 10–3

Figure 10-2.CDM-625A Front Panel ODU Operation Menu Tree – (FW Ver. 1.3.1) 10–4

Figure 10-3. CDM-625A HTTP (Web Server) Interface Home Page 10–35

Figure 10-4. CDM-625A HTTP (Web Server) Interface Menu Tree (FW Ver. 1.3.1)..... 10–36

Figure 10-5. Configuration | BUC page..... 10–37

Figure 10-6. Configuration | LNB page 10–38

Figure 10-7. Status | Modem Logs | Base Modem page 10–39

Figure 10-8. ODU | Enable page 10–42

Figure 10-9. ODU | Config page (CSAT-5060) 10–43

Figure 10-10. ODU | Config page (KST-2000A/B) 10–46

Figure 10-11. ODU | Status page (CSAT-5060) 10–48

Figure 10-12. ODU | Status page (KST-2000A/B)..... 10–49

Figure 10-13. ODU | Utilities page (CSAT-5060) 10–50

Figure 10-14. ODU | Utilities page (KST-2000A/B) 10–52

Figure 10-15. CDM-625A Telnet Command Line Interface (CLI)..... 10–53

Figure A-1. EIA-530 to EIA-422/449 DCE Conversion Cable (CEFD P/N CA/WR0049) A-2

Figure A-2. EIA-530 to V.35 DCE Conversion Cable A-3

Figure A-3. EIA-232 Remote Control Cable (CDM-625A “Remote Control” Port to User PC 9-Pin Serial Port) A-4

Figure B-1. TPC & LDPC Modes Performance (Relative to Shannon Limit) B–9

Figure B-2. VersaFEC Codes versus Shannon Capacity B–14

Figure B-3. VersaFEC-2 Codes vs. Constrained Capacity (Typical Values Shown)..... B–19

Figure B-4. Viterbi Decoding B–22

Figure B-5. Viterbi with Concatenated RS 220, 200 Outer Code B–23

Figure B-6. 8-PSK/TCM Rate 2/3 Decoding with/without Concatenated RS 219, 201 Outer Code..... B–24

Figure B-7. 16-QAM Rates 3/4 and 7/8 with Concatenated RS 220,200 Outer Code..... B–25

Figure B-8. Sequential Decoding at 64 kbps, BPSK, QPSK, and OQPSK..... B–26

Figure B-9. Sequential Decoding at 2048 kbps QPSK, OQPSK..... B–27

Figure B-10. Sequential Decoding at 512 kbps with Concatenated RS 220,200 Outer Code BPSK, QPSK, OQPSK B–28

Figure B-11. Turbo Product Code Rate 5/16 BPSK..... B–29

Figure B-12. Turbo Product Codec Rate 21/44 BPSK/QPSK/OQPSK B–30

Figure B-13. Turbo Product Codec Rate 3/4 QPSK/OQPSK, 8-PSK/8-QAM, and 16-QAM B–31

Figure B-14. Turbo Product Codec Rate 7/8 QPSK/OQPSK, 8-PSK/8-QAM, and 16-QAM B–32

Figure B-15. Turbo Product Codec Rate 0.95 QPSK/OQPSK and 8-PSK/Q-QAM B–33

Figure B-16. LDPC Codec Rate 1/2 BPSK/QPSK/OQPSK B–34

Figure B-17. LDPC Codec Rate 2/3 QPSK/OQPSK and 8-PSK/8-QAM B–35

Figure B-18. LDPC Codec Rate 3/4 QPSK/OQPSK, 8-PSK/8-QAM, and 16-QAM B–36

Figure B-19. VersaFEC Codec Rate 0.488 BPSK..... B–37

Figure B-20. VersaFEC Codec Rates 0.533, 0.631, 0.706, and 0.803 QPSK..... B–38

Figure B-21. VersaFEC Codec Rates 0.642, 0.711, and 0.780 8-QAM..... B–39

Figure B-22. VersaFEC Codec Rates 0.731, 0.780, 0.829, and 0.853 16-QAM..... B–40

Figure B-23. VersaFEC Codec Extended CCM Rate 0.576 8-QAM and Rate 0.644 16-QAM B–41

Figure B-24. ULL Codec Rate 0.493 BPSK/QPSK and Rates 0.654 and 0.734 QPSK B–42

Figure B-25. VersaFEC-2 Short Block..... B–43

Figure B-26. VersaFEC-2 Short Block..... B–44

Figure B-27. Differential Encoding – No FEC, No Scrambling B-45

Figure E-1. TX Clock Modes..... E-3

Figure E-2. RX Clock Modes..... E-5

Figure E-3. Supported T1 and E1 Framing Formats E-7

Figure E-4. Drop and Insert Clocking..... E-9

Figure E-5. Single-Source Multiple Modems (Looming) E-10

Figure E-6. Single-Source Multiple Modems (Daisy-chain)..... E-10

Figure E-7. G.703 Clock Extension Mode 1 E-13

Figure E-8. G.703 Clock Extension Mode 2 E-14

Figure E-9. G.703 Clock Extension Mode 3 E-15

Figure F-1. Conceptual Block Diagram F-3

Figure F-2. Conventional FDMA Link..... F-5

Figure F-3. Same Link Using CDM-625A and DoubleTalk Carrier-in-Carrier F-6

Figure F-4. Duplex Link Optimization F-6

Figure F-5. DoubleTalk Carrier-in-Carrier Signals..... F-8

Figure F-6. Carrier-in-Carrier Signal Processing Block Diagram F-8

Figure K-1. CDM-625A Ethernet Architecture Design..... K-1

Figure K-2. Improper Use of External Ethernet Switch with CDM-625A K-2

Figure K-3. Ethernet Networking Loop Example (Simplified) K-2

Figure K-4. Networking Loop Example..... K-3

Figure K-5. Hub-to-Hub with Standard Traffic Using Routers..... K-4

Figure K-6. Hub-to-Remotes with Standard Traffic Using Routers or Switches..... K-5

Figure K-7. Point-to-Point Configuration in “Router Multipoint Hub” Working Mode K-6

Figure K-8. Point-to-Multipoint Using Routers K-7

Figure K-9. Point-to-Multipoint Using Switches..... K-8

Figure K-10. Point-to-Multipoint (Router Multipoint Hub Mode) K-9

Figure K-11. Multicast Routing Diagram K-11

Figure K-12. Configuration Example for a Multicast Routing Network K-12

Figure K-13. Configuration Example – Point-to-Point Network with PTP..... K-15

Figure K-14. PTP Master/Slave Assignment Example K-17

Figure L-1. CDM-625A Telnet Interfaces Interfaces (Serial Remote / CLI)..... L-6

Figure L-2. CDM-625A HTTP (Web Server) Interface Home Page..... L-6

Figure M-1. ACM-over-Satellite – Generic Example M-4

Figure M-2. VersaFEC Codes vs. Constrained Capacity..... M-7

Figure M-3. CDM-625A – ACM ModCod Switch Points M-11

Figure M-4. VersaFEC-2 Codes vs. Constrained Capacity (typical values shown)..... M-15

Figure M-5. CDM-625A – ACM Congestion Control..... M-19

Figure R-1. IEEE 802.1q VLAN priority..... R-5

Figure T-1. RADIUS Authentication Process..... T-2

Figure T-2. CDM-625A Front Panel Keypad and Vacuum Fluorescent Display..... T-6

Figure T-3. CDM-625A HTTP (Web Server) Interface Admin | Access page T-7

BLANK PAGE

PREFACE

About this Manual

This manual provides installation and operation information for the Comtech EF Data CDM-625A Advanced Satellite Modem. This is a document intended for the persons responsible for the operation and maintenance of the CDM-625A.

Conventions and References

Patents and Trademarks

See all of Comtech EF Data's Patents and Patents Pending at <http://patents.comtechefdata.com>. Comtech EF Data acknowledges that all trademarks are the property of the trademark owners.

- DoubleTalk® is licensed from “Raytheon Applied Signal Technology”.
- DoubleTalk® is a registered trademark of “Raytheon Applied Signal Technology”.
- Carrier-in-Carrier® is a registered trademark of Comtech EF Data.

Warnings, Cautions, and Notes



A **WARNING** GIVES INFORMATION ABOUT A POSSIBLE HAZARD THAT MAY CAUSE DEATH OR SERIOUS INJURY.



A **CAUTION** gives information about a possible hazard that MAY CAUSE INJURY or PROPERTY DAMAGE.



A **NOTE** gives important information about a task or the equipment.



A **REFERENCE** directs you to additional information about a task or the equipment.

Recommended Standard Designations

The new designation of the Electronic Industries Association (EIA) supersedes the Recommended Standard (RS) designations. References to the old designations may be shown when depicting actual text (e.g., RS-232) displayed on the Front Panel menus, Web Server pages, serial remote interface, Telnet Command Line Interface (CLI), or unit rear panel. All other references in the manual refer to EIA designations.



CAUTION – You must carefully review the following information.

Safety and Compliance

Electrical Safety and Compliance

The unit complies with the **EN 60950 Safety of Information Technology Equipment (Including Electrical Business Machines)** safety standard.



CAUTION – If the unit is operated in a vehicle or movable installation, make sure the unit is stable. Otherwise, EN 60950 safety is not guaranteed.



Sect. 3.3 CDM-625A Ground and Power connections

Grounding



CAUTION – PROPER GROUNDING PROTECTION IS REQUIRED: The installation instructions require that the integrity of the protective earth must be ensured and that the equipment shall be connected to the protective earth connection at all times.

The CDM-625A is designed for connection to a power system that has separate ground, line and neutral conductors. The equipment is not designed for connection to a power system that has no direct connection to ground. It is therefore imperative during installation, configuration, and operation for you to ensure that the unit has been properly grounded using the ground stud provided on the rear panel of the unit.

- In Finland: "Laitte on liitettävä suojamaadoituskoskettimilla varustettuun pistorasiaan."
- In Norway: "Apparatet må tilkoples jordet stikkontakt."
- In Sweden: "Apparaten skall anslutas till jordat uttag."

Electrical Installation

The unit is rated for a nominal operating range of 100-240 volts AC; for the appropriately equipped DC option, nominal operating range is 43-60 volts DC. The unit has a maximum power consumption of 300 watts.

The installation and connection to the line supply must be made in compliance to local or national wiring codes and regulations.

The CDM-625A is shipped with a line inlet cable suitable for use in the country of operation. If it is necessary to replace this cable, ensure the replacement has an equivalent specification.

Examples of acceptable ratings for the cable include HAR, BASEC and HOXXX-X.

Examples of acceptable connector ratings include VDE, NF-USE, UL, CSA, OVE, CEBEC, NEMKO, DEMKO, BS1636A, BSI, SETI, IMQ, KEMA-KEUR and SEV.

Battery



WARNING! THE MODEM CONTAINS A LITHIUM BATTERY. DANGER OF EXPLOSION EXISTS IF THE BATTERY IS INCORRECTLY REPLACED. REPLACE ONLY WITH THE SAME OR EQUIVALENT TYPE RECOMMENDED BY THE MANUFACTURER. DISPOSE OF USED BATTERIES IN ACCORDANCE WITH LOCAL AND NATIONAL REGULATIONS.

Fuses



CAUTION – FOR CONTINUED OPERATOR SAFETY, ALWAYS REPLACE THE FUSES WITH THE CORRECT TYPE AND RATING.

The CDM-625A is fitted with two fuses:

- For AC operation, the unit requires two *common* 4 Amp/250 volts 20mm x 5mm Slow-blow fuses that are contained within a fuse holder that is press-fit into the body of the IEC power inlet module (on the rear panel of the unit).
- For DC operation, the unit requires two *different* fuses that are contained within the individual screw-in receptacles below the terminal block (on the rear panel of the unit).

These DC fuse requirements are as follows:

- Modem Operation – 3 Amp/250 volts 20mm x 5mm Slow-blow fuse.
- BUC Operation – 6.3 Amp/250 volts 20mm x 5mm Slow-blow fuse.

Operating Environment



CAUTION – DO NOT OPERATE THE UNIT IN ANY OF THESE EXTREME OPERATING CONDITIONS:

- **AMBIENT TEMPERATURES LESS THAN 0°C (32°F) OR MORE THAN 50°C (122°F). (MAXIMUM STORAGE TEMPERATURE ALLOWED IS -25°C (-13°F) TO 85°C (185°F)).**
- **PRECIPITATION, CONDENSATION, OR HUMID ATMOSPHERES OF MORE THAN 95% RELATIVE HUMIDITY.**
- **UNPRESSURIZED ALTITUDES OF MORE THAN 2000 METRES (6561.7 FEET).**
- **EXCESSIVE DUST.**
- **FLAMMABLE GASES.**
- **CORROSIVE OR EXPLOSIVE ATMOSPHERES.**

European Union Radio Equipment and Telecommunications Terminal Equipment (R&TTE) Directive (1999/5/EC) and EN 301 489-1

Independent testing verifies that the unit complies with the European Union R&TTE Directive, its reference to EN 301 489-1 (*Electromagnetic compatibility and Radio spectrum Matters [ERM]; ElectroMagnetic Compatibility [EMC] standard for radio equipment and services, Part 1: Common technical requirements*), and the Declarations of Conformity for the applicable directives, standards, and practices that follow:

European Union Electromagnetic Compatibility (EMC) Directive (2004/108/EC)

- **Emissions: EN 55022 Class B** – Limits and Methods of Measurement of Radio Interference Characteristics of Information Technology Equipment.
- **Immunity: EN 55024** – Information Technology Equipment: Immunity Characteristics, Limits, and Methods of Measurement.
- **EN 61000-3-2** – Harmonic Currents Emission
- **EN 61000-3-3** – Voltage Fluctuations and Flicker.
- **Federal Communications Commission Federal Code of Regulation FCC Part 15, Subpart B.**



TO ENSURE THAT THE UNIT COMPLIES WITH THESE STANDARDS, OBEY THESE INSTRUCTIONS:





- Use coaxial cable that is of good quality (e.g., RG58/U (50Ω) or RG59/U (75Ω)) for connections to the IF Tx and Rx (transmit and receive) BNC female connectors.
- Use Type 'D' connectors that have back-shells with continuous metallic shielding.

Type 'D' cabling must have a continuous outer shield (either foil or braid, or both). The shield must be bonded to the back-shell.

- Operate the unit with its cover on at all times.

European Union Low Voltage Directive (LVD) (2006/95/EC)

Symbol	Description
<HAR>	Type of power cord required for use in the European Community.
	CAUTION: Double-pole/Neutral Fusing ACHTUNG: Zweipolige bzw. Neutralleiter-Sicherung

International Symbols			
Symbol	Definition	Symbol	Definition
	Alternating Current		Protective Earth
	Fuse		Chassis Ground



For additional symbols, refer to **Warnings, Cautions and Notes** listed earlier in this Preface.

European Union RoHS Directive (2002/95/EC)

This unit satisfies (with exemptions) the requirements specified in the European Union Directive on the Restriction of Hazardous Substances in Electrical and Electronic Equipment (EU RoHS, Directive 2002/95/EC).

European Union Telecommunications Terminal Equipment Directive (91/263/EEC)

In accordance with the European Union Telecommunications Terminal Equipment Directive 91/263/EEC, do not directly connect the unit to the Public Telecommunications Network.

CE Mark

Comtech EF Data declares that the unit meets the necessary requirements for the CE Mark.

Product Support

For all product support, please call:

+1.240.243.1880

+1.866.472.3963 (toll free USA)

Comtech EF Data Headquarters

<http://www.comtechefdata.com>

Comtech EF Data Corp.

2114 West 7th Street

Tempe, Arizona USA 85281

+1.480.333.2200

Warranty Policy

Comtech EF Data products are warranted against defects in material and workmanship for a specific period from the date of shipment, and this period varies by product. In most cases, the warranty period is two years. During the warranty period, Comtech EF Data will, at its option, repair or replace products that prove to be defective. Repairs are warranted for the remainder of the original warranty or a 90 day extended warranty, whichever is longer. Contact Comtech EF Data for the warranty period specific to the product purchased.

For equipment under warranty, the owner is responsible for freight to Comtech EF Data and all related customs, taxes, tariffs, insurance, etc. Comtech EF Data is responsible for the freight charges only for return of the equipment from the factory to the owner. Comtech EF Data will return the equipment by the same method (i.e., Air, Express, Surface) as the equipment was sent to Comtech EF Data.

All equipment returned for warranty repair must have a valid RMA number issued prior to return and be marked clearly on the return packaging. Comtech EF Data strongly recommends all equipment be returned in its original packaging.

Comtech EF Data Corporation's obligations under this warranty are limited to repair or replacement of failed parts, and the return shipment to the buyer of the repaired or replaced parts.

Limitations of Warranty

The warranty does not apply to any part of a product that has been installed, altered, repaired, or misused in any way that, in the opinion of Comtech EF Data Corporation, would affect the reliability or detracts from the performance of any part of the product, or is damaged as the result of use in a way or with equipment that had not been previously approved by Comtech EF Data Corporation.

The warranty does not apply to any product or parts thereof where the serial number or the serial number of any of its parts has been altered, defaced, or removed.

The warranty does not cover damage or loss incurred in transportation of the product.

The warranty does not cover replacement or repair necessitated by loss or damage from any cause beyond the control of Comtech EF Data Corporation, such as lightning or other natural and weather related events or wartime environments.

The warranty does not cover any labor involved in the removal and or reinstallation of warranted equipment or parts on site, or any labor required to diagnose the necessity for repair or replacement.

The warranty excludes any responsibility by Comtech EF Data Corporation for incidental or consequential damages arising from the use of the equipment or products, or for any inability to use them either separate from or in combination with any other equipment or products.

A fixed charge established for each product will be imposed for all equipment returned for warranty repair where Comtech EF Data Corporation cannot identify the cause of the reported failure.

Exclusive Remedies

Comtech EF Data Corporation's warranty, as stated is in lieu of all other warranties, expressed, implied, or statutory, including those of merchantability and fitness for a particular purpose. The buyer shall pass on to any purchaser, lessee, or other user of Comtech EF Data Corporation's products, the aforementioned warranty, and shall indemnify and hold harmless Comtech EF Data Corporation from any claims or liability of such purchaser, lessee, or user based upon allegations that the buyer, its agents, or employees have made additional warranties or representations as to product preference or use.

The remedies provided herein are the buyer's sole and exclusive remedies. Comtech EF Data shall not be liable for any direct, indirect, special, incidental, or consequential damages, whether based on contract, tort, or any other legal theory.

Chapter 1. INTRODUCTION

1.1 Overview



Figure 1-1. CDM-625A Advanced Satellite Modem

The CDM-625A Advanced Satellite Modem (**Figure 1-1**) is intended for both closed network and legacy Intelsat applications. It serves as the replacement for the CDM-625. It is 100% backwards compatible with the CDM-625, but incorporates new features and expansion capability.

- It is compact – 1RU high and 17.6 inches deep – and consumes only 48 watts (typical).
- It features front panel LED Indicators, a keypad, and a Vacuum Fluorescent Display (VFD) for local configuration and monitoring and control (M&C). It also can be fully remote-controlled through its serial remote control or Ethernet-based HTTP (Web Server), SNMP or Telnet Command Line interfaces.

Compared with the CDM-625, additional front panel LEDs are incorporated that permit a clearer visual indication of the status of the unit.

- It provides a full range of built-in (i.e., no plug-in cards required) traffic data interface types, including EIA-530/422, all G.703 types, Quad E1 Drop and Insert, HSSI, ASI, and 10/100 Ethernet.
- Its IF frequency range simultaneously covers 50-180 MHz and 950-2250 MHz. The extension to 2250 MHz is to address the needs of future high-throughput satellites (HTS).
- It supports an entirely new family of waveforms – VersaFEC-2®.
- It provides Viterbi, Sequential, concatenated Reed-Solomon (RS), Trellis Coded Modulation (TCM), Turbo Product Coding (TPC), Low-density Parity Check Coding (LDPC), VersaFEC® (short-block, low latency LDPC) , and VersaFEC-2® (VFEC-2) as Forward Error Correction (FEC) options.

- It offers variable data rates, from 18 kbps to 25 Mbps, in BPSK, QPSK, Offset QPSK (OQPSK), 8PSK, 8-QAM, 16-QAM, 8-ARY (VFEC-2), 16-ARY (VFEC-2), and 32-ARY (VFEC-2) modes.
- It supports a complete range of transmit filter options (spectrum shaping). Transmit alphas of 0.05, 0.10, 0.15, 0.20, 0.25 and 0.35 are included, which in turn permits you to reduce channel spacing as transmit alpha (and hence occupied bandwidth) reduces, providing potentially significant gains in transponder bandwidth efficiency.



See Appendix S. TRANSMIT SPECTRUM FILTERING OPTIONS for important information about these new options.

- Its demod design incorporates fast acquisition, optimal composite power handling, and an integrated adaptive equalizer.
- It includes VersaFEC and VersaFEC-2 Adaptive Coding and Modulation in the base hardware to increase capacity on IP links.
- It includes DoubleTalk[®] Carrier-in-Carrier[®] in the base hardware, and no longer requires a separate plug-in card. (However, FAST codes are still required to activate this option.)
- It can be equipped with an optional IP Packet Processor card that, in addition to providing Layer 3 functionality, incorporates a number of key features for Wide Area Network (WAN) bandwidth optimization: very low overhead Streamline Encapsulation (SLE), Header and Payload Compression, Advanced Quality of Service (QoS), and Advanced Encryption Standard (AES) Encryption.
- IEEE-1588v2 Precision Timing Protocol (PTP) and Jumbo Frame Support are available options.
- It features an internal expansion slot that is available for future FEC options, etc. The new base hardware includes sufficient FPGA and memory resources to permit Comtech EF Data to continue to update the capability of the modem as new technologies emerge.
- A specialized version of the CDM-625A – the CDMER-625A – is also available. In addition to the features listed previously, this Environmentally Resistant (ER) version of the CDM-625A offers added protection in more aggressive operating environments that have a higher concentration of dust, sand and salt. The ER version also provides an extended operating temperature range of 0° to 60° C.

The ER version uses an application of Urethane Conformal Coating (CC) and critical interface protective covers for enhanced protection against dust, sand, and salt. Special protective Conformal Coating and protective covers are used and have been designed to ensure that the CDMER-625A meets MIL-STD-810G requirements including Method 510 Procedure I (Blowing Dust), Method 510 Procedure II (Blowing Sand), and Method 509 (Salt Fog). Both the CC and protective connector covers are fabricated using non-nutrient fungal growth materials.

The ER version is not designed to be used in an uncontrolled environment or outdoor application.

1.2 Functional Description

The CDM-625A has two fundamentally different types of interface - IF and data:

- The IF interface provides a bidirectional link with the satellite via the uplink and downlink equipment.
- The data interface is a bidirectional path that connects with the customer's equipment (assumed to be the DTE) and the modem (assumed to be the DCE).

Transmit data is received by the terrestrial interface where line receivers convert the clock and data signals to CMOS levels for further processing. A small FIFO follows the terrestrial interface to facilitate the various clocking and framing options. If framing is enabled, the transmit clock and data output from the FIFO pass through the framer, where the overhead data (IDR, IBS, D&I or EDMAC) is added to the main data; otherwise, the clock and data are passed directly to the Forward Error Correction encoder.

In the FEC encoder, the data is differentially encoded, scrambled, and then convolutionally or block encoded. Following the encoder, the data is fed to the transmit digital filters, which perform spectral shaping on the data signals. The resultant in-phase (I) and quadrature (Q) signals are then fed to the BPSK, QPSK/OQPSK, 8PSK, 8-QAM, 16-QAM, 8-ARY, 16-ARY, and 32-ARY modulator.

The carrier is generated by a frequency synthesizer, and the I and Q signals directly modulate this carrier. For L-Band applications, the directly modulated signal comprises the main output. For IF applications (50–180 MHz), the L-Band signal is mixed down and filtered to produce the desired output. The Rx-IF signal at L-Band is processed by a dual IF superheterodyne receiver.

For IF applications (50–180 MHz), the signal is first mixed up to the first IF frequency. The second conversion is a complex mix, resulting in the signal once more being split into in-phase (I) and a quadrature (Q) components, producing an output at near-zero frequency. An AGC circuit maintains the desired signal level constant over a broad range. Following this, the I and Q signals are sampled by high-speed (flash) A/D converters. All processing beyond this conversion is purely digital, performing the functions of Nyquist filtering, carrier recovery, and symbol timing recovery. The resultant demodulated signal is fed, in soft decision form, to the selected FEC decoder, which can be Viterbi, Sequential, TCM, Reed-Solomon, TPC, LDPC, VersaFEC, or VersaFEC-2.

After decoding, the recovered clock and data pass to the de-framer (if IBS, IDR, D&I or EDMAC framing is enabled), where the overhead information is removed. Following this, the data passes to the Plesiochronous/Doppler buffer, which has a programmable size, or may be bypassed. From here, the receive clock and data signals are routed to the terrestrial interface, and are passed to the externally connected DTE equipment.

1.3 Features

1.3.1 Physical Description

The CDM-625A is constructed as a 1RU-high rack-mounting chassis, which can be free-standing if desired. Handles at the front ease placement into and removal from a rack.

The CDM-625A modem chassis assembly (CEFD P/N PL-0021325 Standard AC Chassis or CEFD P/N PL-0021327 Optional DC Chassis) is physically comprised of two main card assemblies:

- **Baseband Framing Card (CEFD P/N PL-0021331 or PL-0021534).** This first card includes all of the interface circuits, the framer/de-framer, plesiochronous/Doppler buffer, Reed Solomon outer codec, HDLC framer, Ethernet switch, and the main microcontroller.
- **Modem Card (CEFD P/N PL-0021330).** This second card is the modem itself. It performs all signal processing functions of modulation, demodulation, and primary Forward Error Correction.

1.3.2 Modem Compatibility

The CDM-625A is fully backwards-compatible with the Comtech EF Data CDM-625, CDM-500, CDM-550, and CDM-550T modems. As an Open Network Modem, the CDM-625A is fully compatible with modems from other manufacturers that are compliant with the IESS-308/309/310/314 specifications. Note, however, that IESS-315 (VSAT Turbo) defines closed network operation, and this therefore requires modems from the *same manufacturer* at both ends of the link.

The unit is also fully backwards-compatible with the CDM-600 and CDM-600L modems (With the exception of a lower data rate range of 18 kbps). The modem includes software emulation of CDM-600 and CDM-600L.

1.3.3 Verification

The CDM-625A includes many test modes and loopbacks for rapid verification of the correct functioning of the unit. Of particular note is the IF loopback, which permits you to perform a quick diagnostic test without having to disturb external cabling. During the loopback, all of the receive configuration parameters are temporarily changed to match those of the transmit side, and an internal RF switch connects the modulator output to the demodulator input. When normal operation is again selected, all of the previous values are restored.

1.3.4 Updating Modem Firmware



Chapter 4. UPDATING FIRMWARE

The CDM-625A stores its firmware internally in flash memory, which simplifies the firmware updating process without having to open the modem. Firmware downloads are available via the

Internet from Comtech EF Data's Web site, via e-mail, or on CD, and can be transferred from an external client PC once connectivity has been established with the modem.

1.3.5 Standard Data Interfaces



Chapter 3. REAR PANEL CONNECTORS AND PINOUTS

The CDM-625A includes a universal data interface that eliminates the need to exchange interface cards for different applications. The interfaces offered, as standard, include:

- RS-422 (EIA530) DCE (at rates up to 14 Mbps)
- X.21 DTE and DCE (at rates up to 2.048 Mbps)
- V.35 DCE (at rates up to 14 Mbps)
- G.703 E1, balanced and unbalanced
- G.703 T1, balanced
- G.703 E2, unbalanced
- G.703 T2, balanced and unbalanced
- Quad E1 Drop and Insert (QDI) – up to 4 balanced E1ports
- Serial LVDS (at rates up to 25 Mbps)
- HSSI (at rates up to 25 Mbps)
- ASI
- Four-port Ethernet 10/100 BaseT switch for IP bridging and routing
- Dual Audio, 600Ω (produces a single 64 kbps data stream with either IBS or EDMAC framing)

1.3.6 Optional Hardware and Accessories

Table 1-1 identifies the available hardware options and accessories that can be factory-installed at the time of ordering or user-installed in the field. Refer to the specified manual section for further information or details. Contact Comtech EF Data Product Support to purchase any of these products.

Table 1-1. CDM-625A Optional Hardware and Accessories

Feature	CEFD P/N	Description	Sect.
VersaFEC-2	PL-0021334	VersaFEC-2 Option Card	M.13.3
	KT-0020932	VersaFEC-2 Field Upgrade Kit	
LDPC/TPC	KT-0000093	Combination Low-density Parity Check / TPC Codec daughter card providing data rates up to 25 Mbps and a full range of code rates/modulation	B.7
IP Packet Processor	KT-0000176	IP Packet Processor daughter card with Fan	L.1.1
	KT-0021771	IP Packet Processor Kit for AC units (includes 120W Power Supply)	
	KT-0021773	IP Packet Processor Kit for DC units (includes 120W Power Supply).	
Rack Installation	KT/6228-2	Rear Rack-Mount Kit – 4” Bracket	2.2.1
	KT/6228-3	Rear Rack-Mount Kit – 10” Bracket	
Data Interface	PL-0000307	CiC-60 (HSSI) Interface Adapter Module	3.2.2.1.1
	CA-0000163	Quad E1 Adapter Y-Cable (for 2 E1 Ports: D-Type 9-pin Male to 2X D-Type 15-pin Female)	3.2.2.2.3.1
	CA-0000164	Quad E1 Adapter Y-Cable (for 2 E1 Ports: D-Type-9-pin Male to 2X RJ-48)	3.2.2.2.3.2
	KT-0000122	Quad E1 Balanced/Unbalanced Adapter Kit / Y-Cable, 6”	3.2.2.2.3.3
	KT-0020570	Quad E1 Balanced/Unbalanced Adapter Kit / Y-Cable, 3 ft	
	CA/WR12685-1	VB.35 to EIA-530 Adapter Cable: 25-pin D-Type Male to 37-pin D-Type Female, 8” (RTS/CTS Control)	N/A
AC Power	KT-0020703	AC to 24V DC Conversion Kit	3.3.2
	KT-0020775	AC to 48V DC Conversion Kit	
	KT-0000282	AC Primary Power Supply: 100-240 VAC (65W Power Supply) w/req'd cables	
	KT-0020769	AC Primary Power Supply: 100-240 VAC (175W Power Supply) w/req'd cables	
	PS-0000075	AC 65W Power Supply	
	PS-0020524	AC 120W Power Supply	
	CA/17725	AC Power Cord, Standard (IEC-60320 Type C13) – USA	
	CA/90025-5FT	AC Power Jumper Cord, Standard (IEC-60320 Type C13)	
	KT/11633-1	AC Power Cord Retainer Kit (for any AC Cord)	
AC Power (cont.)	CA/17850	AC Power Cord – European / French	3.3.2
	PP-0000097	AC Power Cord – Japanese	
	PP-0020556	AC Power Cord – India	
	CA/PWR83221	AC Power Cord – United Kingdom	
	WI/86516035-AUS	AC Power Cord – Australia	
DC Power	PL-0021327	Modem Chassis – DC	3.3.3
	KT-0020683	DC to AC Conversion Kit for CDM-625A Base Modem	
	KT-0020777	DC to AC Conversion Kit for CDM-625A with IP Packet Processor	
	KT-0020692	DC Primary Power Supply: -48 VDC, w/req'd cables	
	PS-0020519	DC 48V 120W Power Supply	
	PS-0020504	DC 24V 120W Power Supply	
	CA-0000455	DC Pigtail Adapter	
	CA/WR10327-1	DC Power Cord – 48VDC	
BUC Power Supplies	KT/9640-3	BUC Power Supply: 24 VDC 90W (50° C) (100-240 VAC Input)	N/A
	KT-0000029	BUC Power Supply: 48 VDC 150W (50° C) (100-240 VAC Input)	
	KT-0000185	BUC Power Supply: 24 VDC 90W (50° C) (-48 VDC Input)	
	KT-0000186	BUC Power Supply: 48 VDC 150W (50° C) (-48 VDC Input)	

1.3.7 Fully Accessible System Topology (FAST)



Chapter 5. FAST ACTIVATION PROCEDURE

The CDM-625A Advanced Satellite Modem incorporates a number of optional features. In order to permit a lower initial cost, you may purchase the unit enabled with only the desired features.

If you wish to upgrade the functionality of a unit at a later date, Comtech EF Data provides **Fully Accessible System Topology (FAST)**, which permits the purchase and activation of options through special authorization codes. You may contact Comtech EF Data Product Support to purchase these unique, register-specific **Fast Access Codes**, and then load these codes into the unit using either the front panel keypad or the CDM-625A HTTP (Web Server) Interface.

FAST Accessible Options: **Table 1-2** shows the FAST and FAST-accessible hardware options available for the CDM-625A. The base CDM-625A unit is equipped with Viterbi and Reed-Solomon codecs. It offers BPSK, QPSK, and OQPSK modulation types, and data rates up to 5.0 Mbps, with all interface types. While it is limited to Closed Network operation, it also includes EDMAC and AUPC.

Table 1-2. CDM-625A FAST and FAST-accessible Hardware Options

Option	Description and Comments	Installation Method
IF band	50-180 MHz	BASE UNIT
	950-2250 MHz (L-Band)	FAST
Forward Error Correction	Viterbi, Sequential and concatenated Reed-Solomon	BASE UNIT
	LDPC/TPC Codec daughter card	HARDWARE
	VersaFEC Codec	FAST
	VersaFEC-2 Codec	HARDWARE
Data Rate (base function)	Data rate 18 kbps to 5.0 Mbps	FAST
	Data rate 18 kbps to 10.0 Mbps	FAST
	Data rate 18 kbps to 15.0 Mbps	FAST
	Data rate 18 kbps to 20.0 Mbps	FAST
	Data rate 18 kbps to 25.0 Mbps	FAST
Data Rate (LDPC/TPC function)	Data rate 18 kbps to 5.0 Mbps	BASE UNIT
	Data rate 18 kbps to 10.0 Mbps	FAST
	Data rate 18 kbps to 15.0 Mbps	FAST
	Data rate 18 kbps to 20.0 Mbps	FAST
	Data rate 18 kbps to 25.0 Mbps	FAST
Modulation	BPSK, QPSK, OQPSK	BASE UNIT
	8PSK, 8-QAM, 8-ARY	FAST
	16-QAM, 16-ARY	FAST
	32-ARY	FAST
Open Network	All IDR/IBS Open Network features	FAST
Drop and Insert	T1/E1 D&I (single port)	FAST
	Quad E1 Drop and Insert	FAST

Option	Description and Comments	Installation Method	
DoubleTalk Carrier-in-Carrier	Data rate 18 kbps to 512 kbps	FAST	
	Data rate 18 kbps to 1 Mbps	FAST	
	Data rate 18 kbps to 2.5 Mbps	FAST	
	Data rate 18 kbps to 5.0 Mbps	FAST	
	Data rate 18 kbps to 10.0 Mbps	FAST	
	Data rate 18 kbps to 15.0 Mbps	FAST	
	Data rate 18 kbps to 20.0 Mbps	FAST	
	Data rate 18 kbps to 25.0 Mbps	FAST	
VersaFEC Constant Coding and Modulation (CCM)	Data rate 18 kbps to 1.1 Mbps	FAST	
	Data rate 18 kbps to 2.5 Mbps	FAST	
	Data rate 18 kbps to 5.0 Mbps	FAST	
	Data rate 18 kbps to 16.0 Mbps	FAST	
VersaFEC Adaptive Coding and Modulation (ACM)	Symbol rate 37 ksps to 300 ksps	FAST	
	Symbol rate 37 ksps to 1200 ksps	FAST	
	Symbol rate 37 ksps to 4100 ksps	FAST	
VersaFEC-2 Constant Coding and Modulation (CCM)	Data rate 18 kbps to 5 Mbps	FAST	
	Data rate 18 kbps to 10 Mbps	FAST	
	Data rate 18 kbps to 15 Mbps	FAST	
	Data rate 18 kbps to 20 Mbps	FAST	
	Data rate 18 kbps to 25 Mbps	FAST	
VersaFEC-2 Adaptive Coding and Modulation (ACM)	Symbol rate 37 ksps to 1200 ksps	FAST	
	Symbol rate 37 ksps to 2000 ksps	FAST	
	Symbol rate 37 ksps to 4100 ksps	FAST	
	Symbol rate 37 ksps to 8000 ksps	FAST	
	Symbol rate 37 ksps to 12500 ksps	FAST	
G.703 Clock Extension	G.703 Clock Extension	FAST	
Carrier ID	Carrier ID	FAST	
Advanced Network Timing (ANT)	IEEE-1588v2 Precision Timing Protocol (PTP)	FAST	
Main Power Supplies	100-240 VAC Nominal, 90-264 VAC Maximum	HARDWARE	
	43-60 VDC Nominal, 36-60 VDC Maximum	HARDWARE	
BUC Power Supplies	24V, 100W	HARDWARE	
	48V, 150W @ 50° C (180W@ 35° C)	HARDWARE	
IP Packet Processor	Card	IP Packet Processor daughter card	HARDWARE
	Payload Compression	Data rate up to 5 Mbps or Symbol rate up to 2000 ksps (ACM)	FAST
		Data rate up to 10 Mbps or Symbol rate up to 4100 ksps (ACM)	FAST
		Data rate up to 15 Mbps or Symbol rate up to 5000 ksps (ACM)	FAST
		Data rate up to 20 Mbps or Symbol rate up to 12500 ksps (ACM)	FAST
		Data rate up to 25 Mbps or Symbol rate up to 12500 ksps (ACM)	FAST
	Header Compression	Data rate up to 5 Mbps or Symbol rate up to 2000 ksps (ACM)	FAST
		Data rate up to 10 Mbps or Symbol rate up to 4100 ksps (ACM)	FAST
		Data rate up to 15 Mbps or Symbol rate up to 5000 ksps (ACM)	FAST
		Data rate up to 20 Mbps or Symbol rate up to 12500 ksps (ACM)	FAST
		Data rate up to 25 Mbps or Symbol rate up to 12500 ksps (ACM)	FAST
	Advanced QoS	Advanced QoS	FAST
	AES Encryption	Tx Packet Encryption / Rx Packet Decryption	FAST

1.3.8 Supporting Hardware and Software

Redundancy Support: Comtech EF Data provides redundant operations support to the CDM-625A as follows:

- For 1:1 redundancy applications, via its low-cost external CRS-170A L-Band and CRS-180 70/140 MHz IF 1:1 Redundancy Switches.
- For M:N redundancy (hub) applications, via its external CRS-300 1:10 Redundancy Switch or the CRS-500 M:N Redundancy System.

Transceiver Support: The CDM-625A is a companion product for Comtech EF Data's CSAT-5060 and KST-2000A/B RF Transceivers. The modem incorporates a Frequency Shift-keying (FSK) serial link that can be activated on the Rx-IF port for the purpose of communicating with a transceiver, if connected. In this manner, you may configure, monitor and control the transceiver using either the CDM-625A's front panel display and keypad or any of its remote control interfaces. The EDMAC channel may also be used to convey M&C data to a transceiver at the distant end of a satellite link, if it is connected to a CDM-625A.

BUC Support: The CDM-625A incorporates an FSK serial link that can be activated on the Tx-IF port for the purpose of communicating with an FSK-capable "smart" BUC. This link is designed to be compatible with the Global VSAT Forum/ND SatCom specification. In this manner, you may configure, monitor and control the BUC using either the CDM-625A's front panel display and keypad or any of its remote control interfaces.

Additionally, Comtech EF Data provides for an "Advanced FSK" for use with its LPOD BUCs, re-using the existing FSK channel to pass additional "proprietary" commands to expand front panel user control. The EDMAC channel can be used to convey M&C interface to a BUC at the distant end of a satellite link, if it is connected to a CDM-625A.

1.3.9 Physical Features

1.3.9.1 Dimensional Envelope

All dimensions are in inches. Dimensions shown in parentheses are in metric units (mm).

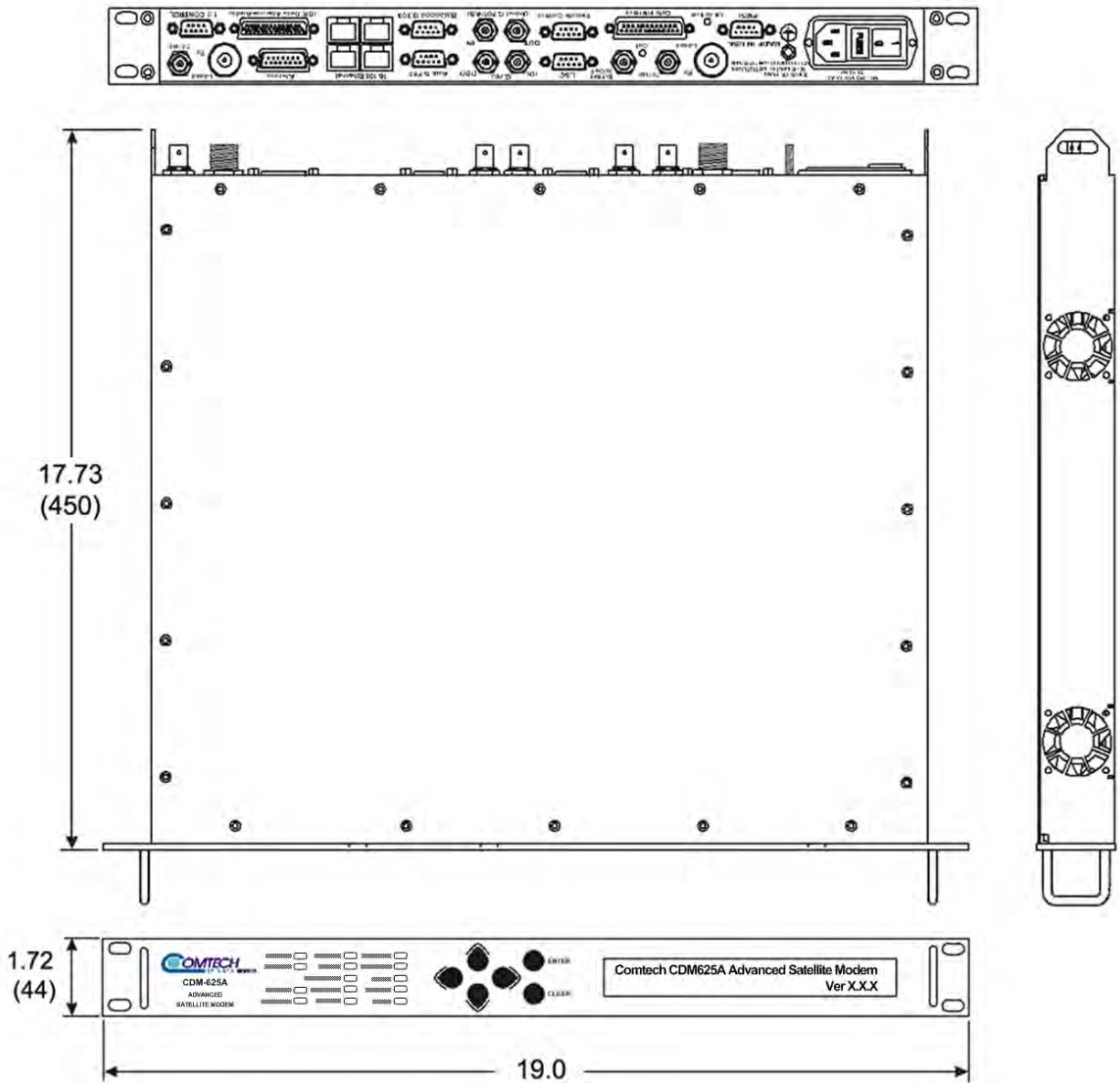
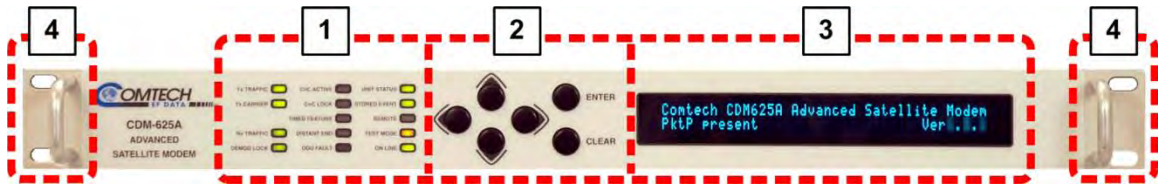

Figure 1-2. CDM-625A Dimensional Envelope

1.3.9.2 Front Panel Features



- Chapter 2. INSTALLATION
- Chapter 6. FRONT PANEL OPERATION



Feature	Description	Function	Sect.
1	LED Indicators	The LEDs indicate, in a summary fashion, the status of the modem.	6.1.1
2	Keypad	The keypad comprises six individual keyswitches. The keys have a positive 'click' action that provides tactile feedback. Enter data via the keypad. Data, prompts, and messages are displayed on the VFD.	6.1.2
3	Vacuum Fluorescent Display (VFD)	The VFD is an active display showing two lines of 40 characters each. It produces a blue light with adjustable brightness. Nested menus display all available options and prompt you to carry out a req'd action.	6.1.3
4	Rack Handles	These handles ease placement into and removal from a rack.	2.2

Figure 1-3. CDM-625A Front Panel Features

1.3.9.3 Rear Panel Features



Chapter 3. REAR PANEL CONNECTORS AND PINOUTS

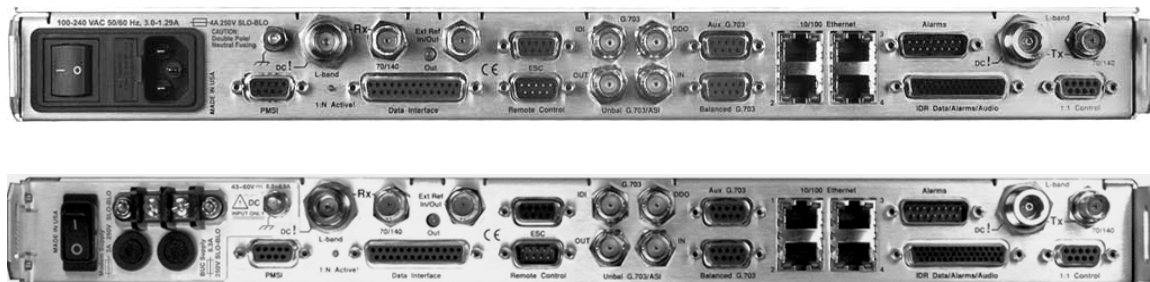

(TOP) Standard AC Chassis (CEFD P/N PL-0021325)
(BOTTOM) Optional 48V DC Chassis (CEFD P/N PL-0021327)

Figure 1-4. CDM-625A Rear Panel View

Figure 1-4 shows the rear panel of the modem. External cables are attached to connectors on the rear panel of the CDM-625A. They comprise:

Connection Group (Chapter Sect.)	Name	Connector Type	Function	
IF (Sect. 3.2.1)	Rx	BNC female (70/140MHz band)	IF Input	
		Type 'N' female (L-Band)		
	Tx	BNC female (70/140MHz band)		IF Output
		Type 'N' female (L-Band)		
Terrestrial Data (Sect. 3.2.2)	Data Interface	25-pin Type 'D' female	Serial synchronous data input/output	
	G.703 Data	Balanced G.703	9-pin Type 'D' female	G.703, D&I or D&I++; Quad E1 Ports 1 & 2
		Auxiliary G.703	9-pin Type 'D' female	Quad E1 Ports 3 & 4
		Unbalanced Out	BNC female	Receive G.703 (IDO); ASI
		Unbalanced In	BNC female	Transmit G.703 (DDI); ASI
		IDI	BNC female	Insert Data In / Sub-rate Auxiliary Tx G.703 In
		DDO	BNC female	Drop Data Output / Sub-rate Auxiliary Rx G.703 Out
	10/100 Ethernet	(4X) RJ-45 female	10/100 BaseT management and data	
	IDR Data/Alarms/Audio	44-pin High Density Type 'D' female	Intelsat Open Network auxiliary signals	
	ESC	9-pin Type 'D' female	ESC input/output (RS232/485)	
Utility (Sect. 3.2.3)	Remote Control	9-pin Type 'D' male	Serial Remote Interface (RS232/485)	
	Alarms	15-pin Type 'D' male	Form C Alarms (relay closures)	
	PMSI	9-pin Type 'D' female	Pre-Mapped Symbol Interface (CnC)	
	1:1 Control	9-pin Type 'D' female	Connection to External 1:1 Controller	
	External Reference	BNC female	Input/output	
Ground / Power (Sect 3.3)	Ground	#10-32 stud – See Sect. 3.3.1	Common Chassis Ground	
	AC Power (Standard)	See Sect. 3.3.2	Chassis power	
	DC Power (Optional)	See Sect. 3.3.3	Chassis power	



The European EMC Directive 2004/108/EEC (EN 55022, EN 50024) requires using properly shielded cables for DATA I/O. These cables must be double-shielded from end-to-end, ensuring a continuous ground shield.

1.4 Summary of Specifications

1.4.1 Modulator

Modulation	BPSK, QPSK, OQPSK, 8PSK, 8-QAM and 16-QAM
Symbol rate range	18 ksp/s to 12.5 Msps
Data rate range	18 kbps - 25 Mbps. See Section 1.4.7
Operating frequency	50 - 180 MHz (BNC connector) AND 950 - 2350 MHz (Type 'N' connector), 100 Hz resolution Stability ± 0.06 ppm ($\pm 6 \times 10^{-8}$) 0° to 50°C (32° to 122°F), when using internal reference
Operating modes	<ul style="list-style-type: none"> • Open Network, per Intelsat IESS-308/309/310/314 (IDR, IBS/SMS) • E1/T1 Drop and Insert • Transparent, Closed Network, IESS-315 (VSAT Turbo) • Proprietary EDMAC framed mode: <ul style="list-style-type: none"> • 5% overhead – EDMAC (data rates < 2.048 Mbps all modes except BPSK Turbo, Rate 21/44 QPSK Turbo) • 1.6% overhead - EDMAC-2 (rates >2.048 Mbps and all Rate 21/44, 5/16 Turbo) • EDMAC-3 – for SNMP Proxy – same as EDMAC • R-S Outer Codec • Turbo Product Codec - 2nd Generation (optional plug-in module) • LDPC Codec (optional plug-in module – includes all 2nd Generation TPC modes) • VersaFEC[®] Codec (short-block, low latency and ultra-low-latency LDPC) • VersaFEC-2[®] Codec (optional plug-in module, long-block, short-block) • VersaFEC[®] Adaptive Coding and Modulation – IP interface only – maximum symbol rate = 4.1 Msps • VersaFEC-2[®] Adaptive Coding and Modulation – IP interface only – maximum symbol rate = 12.5 Msps • Automatic Uplink Power Control (AUPC) mode • High Rate ESC, Enhanced ESC (ESC++) • Enhanced Drop & Insert (D&I++) • Quad E1 Drop & Insert (QDI) - concatenates time slots from up to four E1 G.703 streams, Framed QDI • DoubleTalk[®] Carrier-in-Carrier[®] mode • Carrier-in-Carrier Automatic Power Control (CnC-APC)
FEC	<p>None: Uncoded BPSK/QPSK/OQPSK Viterbi: k=7, per IESS-308/309 BPSK: Rate 1/2 QPSK/OQPSK: Rate 1/2, Rate 3/4 and Rate 7/8 16-QAM: Rate 3/4 and Rate 7/8 (Viterbi plus Reed-Solomon only)</p> <p>Sequential: BPSK: Rate 1/2 QPSK/OQPSK: Rate 1/2, Rate 3/4 and Rate 7/8</p> <p>Reed-Solomon (Open Network): IDR modes: 225/205 for T1 219/201 for E1 and IESS-310 mode, 194/178 for T2 and E2</p> <p>IBS modes: 126/112 and 219/201 for IESS-310 mode</p> <p>Reed-Solomon (Closed Network): 220,200 outer code (transparent mode) 225,205 outer code (transparent mode, EF Data compatible, V.35 scrambling) 126,112 outer code (transparent mode, IBS parameters, D&I++ mode) 219,201 outer code (transparent mode, IESS-310 parameters) 200,180 outer code (EDMAC modes) Interleaver depth = 4 or 8 (depending on mode)</p> <p>8PSK/TCM Rate 2/3 (Trellis): Per IESS-310 Turbo Product Codec, 2nd Generation (Optional plug-in card, includes LDPC modes): Rate 5/16 (2 dimensional) and Rate 21/44 (3-dimensional) BPSK Rate 21/44 QPSK/OQPSK (aka 1/2) - 3 dimensional Rate 3/4 QPSK/OQPSK/8PSK/8-QAM/16-QAM - 2 dimensional Rate 7/8 QPSK/OQPSK/8PSK/8-QAM/16-QAM - 2 dimensional Rate 0.95 QPSK/OQPSK/8PSK/8-QAM/- 2 dimensional TPC (exact Code Rate is actually 17/18, or 0.944)</p>

<p>FEC (cont.)</p>	<p>Low Density Parity Check (LDPC) Codec (Optional plug-in card): Rate 1/2 BPSK/QPSK/OQPSK Rate 2/3 QPSK/OQPSK/8PSK/8-QAM Rate 3/4 QPSK/OQPSK/8PSK/8-QAM/16-QAM VersaFEC Codec (Optional plug-in card – short-block, low latency LDPC): Rate 0.488 BPSK (also 0.493 BPSK Ultra-Low-Latency) Rate 0.533, 0.631, 0.706, 0.803 QPSK (0.493, 0.654, 0.734 Ultra-Low-Latency) Rate 0.642, 0.711, 0.780 8-QAM (also 0.576 8-QAM Extended CCM) Rate 0.731, 0.780, 0.829, 0.853 16-QAM (also 0.644 16-QAM Extended CCM) VersaFEC-2 Long-Block Codec (Optional plug-in card – low latency LDPC): Rate 0.489 BPSK Rate 0.489, 0.537, 0.586, 0.611, 0.635, 0.660, 0.684, 0.733 QPSK Rate 0.521, 0.537, 0.562, 0.586, 0.611, 0.635, 0.660, 0.684, 0.708, 0.733 8-ARY Rate 0.586, 0.611, 0.635, 0.660, 0.684, 0.708, 0.733, 0.757, 0.782 16-ARY Rate 0.660, 0.684, 0.708, 0.733, 0.757, 0.782, 0.801, 0.831, 0.855, 0.879 32-ARY VersaFEC-2 Short-Block Codec (Optional plug-in card – low latency LDPC): Rate 0.489 BPSK Rate 0.489, 0.537, 0.586, 0.611, 0.635, 0.660, 0.684, 0.733 QPSK Rate 0.521, 0.537, 0.562, 0.586, 0.611, 0.635, 0.660, 0.684, 0.708, 0.733 8-ARY Rate 0.586, 0.611, 0.635, 0.660, 0.684, 0.708, 0.733, 0.757, 0.782 16-ARY Rate 0.660, 0.684, 0.708, 0.733, 0.757, 0.782, 0.801, 0.831 32-ARY</p>										
<p>Transmit filtering</p>	<p>Root-Raised Cosine, alpha = 0.05, 0.10, 0.15, 0.20, 0.25, and 0.35 – front panel/software selectable See graphs of output spectrum provided at the end of this section</p>										
<p>Scrambling</p>	<p>IDR Mode, no RS, - per ITU V.35 (Intelsat variant) IBS mode, no RS - per IESS-309, externally frame synchronized Transparent Closed Network mode, no RS or Turbo coding - per ITU V.35 (Intelsat variant) EDMAC mode, no RS coding - externally frame synchronized - proprietary Turbo Product Code/LDPC/VersaFEC modes - externally frame synchronized - proprietary All RS modes - externally frame synchronized per IESS-308/309/310 All VersaFEC®, VersaFEC-2® modes use IESS-315/V.35 All DoubleTalk® Carrier-in-Carrier® modes, regardless of FEC type, use IESS-315/V.35</p>										
<p>External Reference</p>	<p>As an input: 1, 2, 5 or 10MHz -6dBm to +10dBm (nominal 50/75 Ω, BNC female connector) As an output: 10MHz, 2.7 volts peak-to-peak ±0.4 volts, low impedance output (The Ext. reference phase locks Tx and Rx synthesizers, and all baseband clock generation)</p>										
<p>Harmonics/spurious</p>	<p>Better than -60 dBC/4 kHz (typically <-65 dBC/4kHz) 950-2250 MHz band: measured F₀ ±500 MHz 50-180 MHz band: measured from 1 to 500 MHz</p>										
<p>Transmit on/off ratio</p>	<p>-60 dBC minimum</p>										
<p>Output phase noise</p>	<p>< 0.48^{rms} double sided, 100 Hz to 1MHz (minimum of 16 dB better overall than the INTELSAT IESS-308/309 requirement)</p> <table border="1" data-bbox="444 1287 755 1419"> <thead> <tr> <th>dB/Hz</th> <th>Frequency Offset</th> </tr> </thead> <tbody> <tr> <td>-63.0</td> <td>100 Hz</td> </tr> <tr> <td>-73.0</td> <td>1 kHz</td> </tr> <tr> <td>-83.0</td> <td>10 kHz</td> </tr> <tr> <td>-93.0</td> <td>100 kHz</td> </tr> </tbody> </table> <p>Fundamental AC line spurious is -42 dBc or lower The sum of all other single sideband spurious, from 0 to 0.75 x symbol rate, is -48 dBc or lower</p>	dB/Hz	Frequency Offset	-63.0	100 Hz	-73.0	1 kHz	-83.0	10 kHz	-93.0	100 kHz
dB/Hz	Frequency Offset										
-63.0	100 Hz										
-73.0	1 kHz										
-83.0	10 kHz										
-93.0	100 kHz										
<p>Output power</p>	<p>950-2250 MHz band: 0 to -40 dBm, 0.1 dB steps - manual mode. See AUPC section also 50-180 MHz band: 0 to -25 dBm, 0.1 dB steps - manual mode. See AUPC section also</p>										
<p>Power accuracy</p>	<p>950-2250 MHz band: ±0.7 dB over frequency, data rate, modulation type and temperature range 15° to 35°C ±1.0 dB over frequency, data rate, modulation type and temperature range 0° to 50°C 'ER' Version: ±0.8 dB over frequency, data rate, modulation type and temperature range 15° to 35°C ±1.1 dB over frequency, data rate, modulation type and temperature range 0° to 50°C</p> <p>50-180 MHz band: ±0.5 dB over frequency, data rate, modulation type and temperature range 15° to 35°C ±0.8 dB over frequency, data rate, modulation type and temperature range 0° to 50°C 'ER' Version: ±0.6 dB over frequency, data rate, modulation type and temperature range 15° to 35°C ±0.9 dB over frequency, data rate, modulation type and temperature range 0° to 50°C</p>										

Output impedance	<p>950-1950 MHz band: 50Ω, 19 dB minimum return loss (21 dB typical) 1950-2250 MHz band: 17dB minimum 50-180 MHz band: 50Ω, or 75Ω 16 dB minimum return loss (18 dB typical)</p>												
Output connector	<p>950-2250 MHz band: Type N female 50-180 MHz band: BNC female</p>												
Clocking options	<p>Internal, ±0.06 ppm (SCT) External, locking over a ±100 ppm range (TT) Loop timing (Rx satellite clock) - supports asymmetric operation - Rx and Tx data rates need not be identical External Clock G.703 Clock Extension mode – internal ST clock can be slaved to an external T1 or E1 G.703 signal, and a G.703 timing signal re-constituted at the distant end of the link, regardless of the actual link data rate</p>												
External TX Carrier Off	By TTL 'low' signal or external contact closure - hardware function automatically over-rides processor												
BUC Reference (10 MHz): Phase Noise	<p>On center conductor of L-Band output connector; 10.0 MHz ± 0.06 ppm (internal reference selected) 0.0 dBm, ± 3 dB; programmable ON/OFF Source: either Internal Modem Reference or External Reference (10 MHz)</p> <table border="1"> <thead> <tr> <th>dB/Hz</th> <th>Frequency Offset</th> </tr> </thead> <tbody> <tr> <td>-105</td> <td>10 Hz</td> </tr> <tr> <td>-125</td> <td>100 Hz</td> </tr> <tr> <td>-138</td> <td>1 kHz</td> </tr> <tr> <td>-148</td> <td>10 kHz</td> </tr> <tr> <td>-150</td> <td>100 kHz</td> </tr> </tbody> </table>	dB/Hz	Frequency Offset	-105	10 Hz	-125	100 Hz	-138	1 kHz	-148	10 kHz	-150	100 kHz
dB/Hz	Frequency Offset												
-105	10 Hz												
-125	100 Hz												
-138	1 kHz												
-148	10 kHz												
-150	100 kHz												
BUC Supply Voltage	<ul style="list-style-type: none"> Standard unit has no BUC supply. Optional BUC Supply: <ul style="list-style-type: none"> 24VDC, 4.17 Amps maximum, 100W 48VDC, 3.125 Amps maximum, 150W @ 50° C (180 watts @ 30° C) Supplied through Tx IF center conductor and selectable ON/OFF via M&C control. 												
BUC Current Monitor	Min/Max programmable current alarm thresholds.												
Tx Carrier ON Delay	Selectable feature power on to allow internal ovenized reference to stabilize before turning on Tx carrier. Intelligent algorithm minimizes delay time based on internal temperature at power-up.												
BUC Monitoring	Power level, temperature, power class, PLL lock. Uses ND Satcom/Global VSAT Forum specification for FSK control and monitoring.												

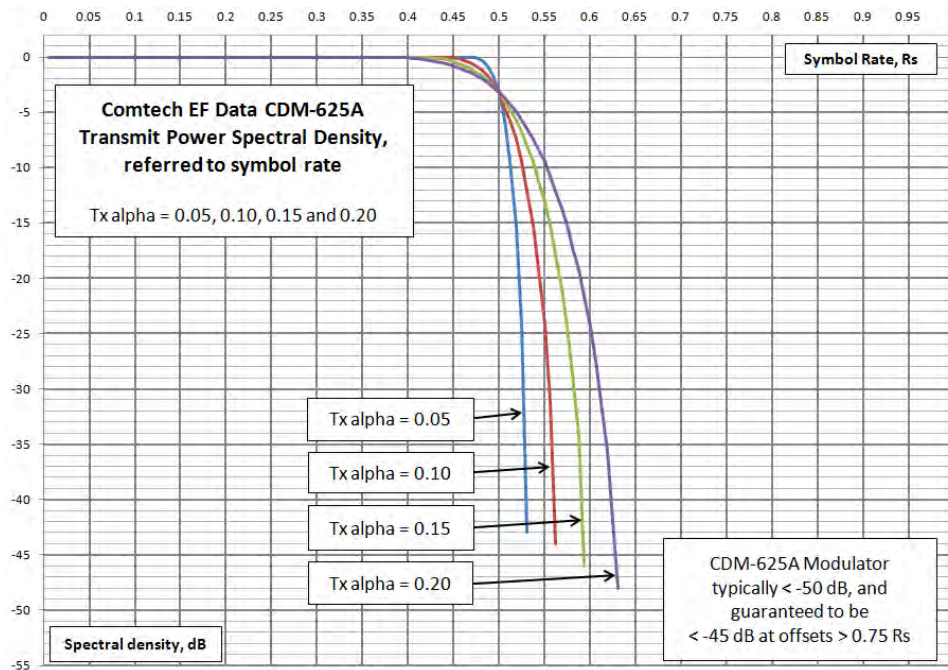

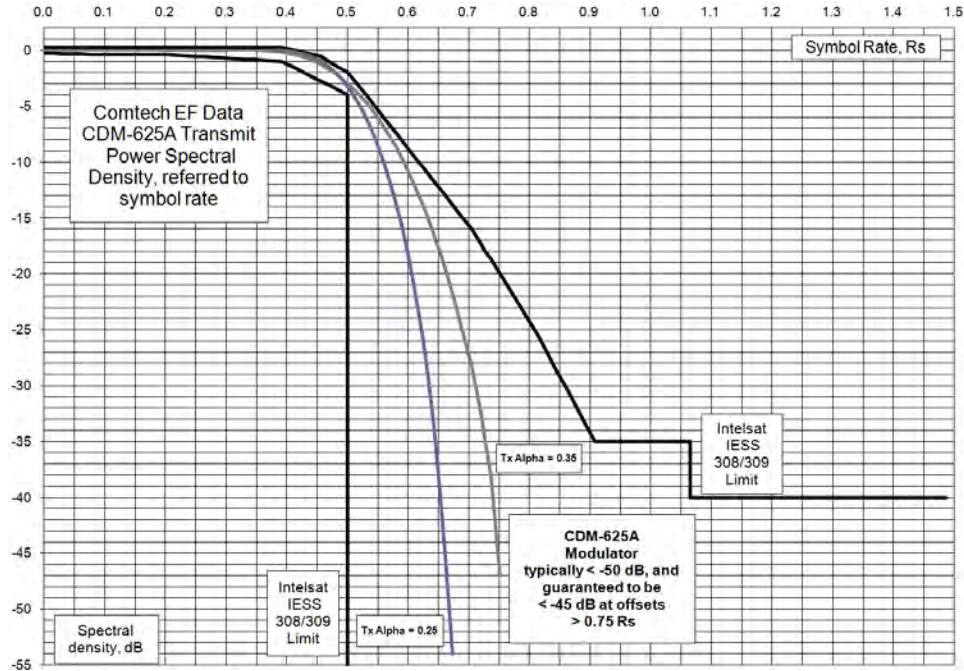

1.4.2 Demodulator

Note: Data rate range, operating modes, descrambling, input impedance/return loss etc, as per **Sect. 1.4.1 Modulator**.

Input power range, desired carrier	<p>950-2250 MHz band: $-130 + 10_{\log}(\text{symbol rate})$ to $-80 + 10_{\log}(\text{symbol rate})$ dBm</p> <p>50-180 MHz band: $-105 + 10_{\log}(\text{symbol rate})$ to $-70 + 10_{\log}(\text{symbol rate})$ dBm</p>
Maximum Composite Operating Level	<p>950-2250 MHz band: $102 - 10_{\log}(\text{symbol rate, desired carrier})$ dBC, +10 dBm max, with the additional requirement that within ± 10 MHz of the desired carrier, composite power is $\leq +30$ dBC.</p> <p>50-180 MHz band: $94 - 10_{\log}(\text{symbol rate, desired carrier})$ dBC, +10 dBm max, with the additional requirement that within ± 10 MHz of the desired carrier, composite power is $\leq +30$ dBC</p>
Absolute Maximum, No Damage	+20 dBm
FEC	<p>Viterbi: 3 bit soft decision Sequential: 2 bit soft decision Trellis: Per IESS-310 Reed-Solomon(Open Network): Per IESS-308/309/310 Reed-Solomon(Closed Network): Proprietary Turbo Product Codec: 6 bit soft decision, proprietary LDPC: 5 bit soft decision, proprietary VersaFEC: 6 bit soft decision, proprietary VersaFEC-2: 8 bit soft decision, proprietary</p>
Adaptive Equalizer	5-tap design, selectable on/off
Acquisition range	<p>Programmable in 1kHz increments, and subject to the following:</p> <p>Below 64 ksymbols/sec: ± 1 to $\pm(R_s/2)$ kHz, where R_s = symbol rate in ksymbols/sec</p> <p>Between 64 and 389 ksymbols/sec: ± 1 up to a maximum of ± 32kHz</p> <p>Above 389 ksymbols/sec: ± 1 to $\pm(0.1R_s)$ kHz, up to a maximum of ± 300 kHz</p>
Acquisition time	<p>Highly dependent on data rate, FEC rate, and demodulator acquisition range.</p> <p>Examples: 120 ms average at 64 kbps, R1/2 QPSK, ± 10 kHz acquisition sweep range, 6dB Eb/No</p> <p>2 s average at 18 kbps, R1/2 QPSK, ± 10 kHz, 6dB Eb/No</p> <p>Note: The use of Reed-Solomon, TPC, LDPC, VersaFEC increases acquisition time, due to the additional time taken for these decoders to declare synchronization.</p>
Clock tracking range	± 100 ppm min
Clocking modes	Full range of clocking options supported – see plesiochronous/Doppler buffer section

LNB 10 MHz Reference	On center conductor of L-Band input connector, selectable ON/OFF. Level: -3dBm ± 3 dB. Source: either Internal modem reference or External reference Performance: For phase noise, refer to L-Band modulator 10 MHz. Frequency stability same as the modulator 10 MHz reference.
LNB Voltage	On center conductor of L-Band input connector, selectable ON/OFF, 13, 18 volts per DiSeq 4.2 and 24VDC at 500 mA maximum.
LNB Current Alarm	Programmable Min/Max current alarms.
Plesiochronous/ Doppler Buffer	Selectable size of 64 to 262,144 bits, in 16-bit steps (With added limitations for G.704 frame boundaries). Size selection is displayed in bytes and milliseconds. Supports asymmetric operation - when buffer is clocked from Tx clock, Rx and Tx rates do not need to be identical.
Monitor Functions	Eb/No estimate: 2 to 10 dB with ±0.3 dB accuracy 0 to 16 dB with ±0.5 dB accuracy Corrected Bit Error Rate, 1E-3 to 1E-10 Frequency offset, ±32 kHz range, (or 200 kHz range, depending on band and symbol rate) 100 Hz resolution Buffer fill state, in percent Receive signal level: 950-2250 MHz band accuracy: ±3 dB 50-180 MHz band accuracy: ±2 dB Receive signal level – ‘ER’ VERSION: 950-2250 MHz band accuracy: ±4 dB 50-180 MHz band accuracy: ±3 dB



BER Performance on CDMER-625A Version units may degrade 0.1 to 0.2 dB from the specifications that follow, when operated under extreme conditions.

VITERBI BER performance (met in the presence of two adjacent carriers, each 7 dB higher than the desired carrier)	For BER=10 ^{-x}	Rate – Guaranteed Eb/No (typical value in parentheses)		
		Rate 1/2 (B, Q, OQ)	Rate 3/4 (Q, OQ)	Rate 7/8 (Q, OQ)
	BER=10 ⁻⁵ BER=10 ⁻⁶ BER=10 ⁻⁷	5.4 dB (4.9 dB) 6.0 dB (5.5 dB) 6.7 dB (6.2 dB)	6.8 dB (6.3 dB) 7.4 dB (6.9 dB) 8.2 dB (7.7 dB)	7.7 dB (7.2 dB) 8.4 dB (7.9 dB) 9.0 dB (8.6 dB)
VITERBI and RS 220,200 or 200,180 Outer Code BER (With two adjacent carriers, each 7 dB higher than the desired carrier)	BER=10 ⁻⁵ BER=10 ⁻⁶ BER=10 ⁻⁷	Rate 1/2 (B, Q, OQ) 4.3 dB (4.0 dB) 4.4 dB (4.1 dB) 4.5 dB (4.2 dB)	Rate 3/4 (Q, OQ) 5.6 dB (4.7 dB) 5.8 dB (4.8 dB) 6.0 dB (5.2 dB)	Rate 7/8 (Q, OQ) 6.5 dB (6.0 dB) 6.7 dB (6.2 dB) 6.9 dB (6.5 dB)
8PSK/TCM CODEC BER (With two adjacent carriers, each 7 dB higher than the desired carrier)	BER=10 ⁻⁵ BER=10 ⁻⁷ BER=10 ⁻⁸	Rate 2/3 8PSK/TCM 7.9 dB (7.2 dB) 9.5 dB (8.7 dB) 10.4 dB (9.5 dB)	Rate 2/3 8PSK/TCM w/concatenated RS 6.3 dB (5.4 dB) 6.7 dB (5.8 dB) 6.9 dB (6.0 dB)	
16-QAM VITERBI/ 220,200 RS BER (With two adjacent carriers, each 7 dB higher than the desired carrier)	BER=10 ⁻⁶ BER=10 ⁻⁸	16-QAM Rate 3/4 Viterbi/RS 8.1 dB (7.5 dB) 8.6 dB (8.0 dB)	16-QAM Rate 7/8 Viterbi/RS 9.5 dB (9.0 dB) 10.1 dB (9.5 dB)	Attention: For 126,112 Reed-Solomon add 0.2 dB to these figures
SEQUENTIAL at 64 kbps BER performance (met in the presence of two adjacent carriers, each 7 dB higher than the desired carrier)	BER=10 ⁻⁴ BER=10 ⁻⁶ BER=10 ⁻⁸	Rate 1/2 (B, Q, OQ) 4.4 dB (4.0 dB) 5.1 dB (4.6 dB) 5.7 dB (5.2 dB)	Rate 3/4 (Q, OQ) 5.2 dB (4.7 dB) 5.8 dB (5.4 dB) 6.4 dB (6.0 dB)	Rate 7/8 (Q, OQ) 6.2 dB (5.7 dB) 7.0 dB (6.6 dB) 7.9 dB (7.4 dB)
SEQUENTIAL at 2048 kbps BER performance (met in the presence of two adjacent carriers, each 7 dB higher than the desired carrier)	BER=10 ⁻⁴ BER=10 ⁻⁶ BER=10 ⁻⁸	Rate 1/2 (Q, OQ) 5.0 dB (4.6 dB) 5.8 dB (5.4 dB) 6.7 dB (6.3 dB)	Rate 3/4 (Q, OQ) 5.6 dB (5.2 dB) 6.4 dB (6.0 dB) 7.3 dB (6.8 dB)	Rate 7/8 (Q, OQ) 6.5 dB (6.0 dB) 7.6 dB (7.2 dB) 8.7 dB (8.2 dB)
SEQUENTIAL and RS 220,200 Outer Code at 512 kbps BER performance (With two adjacent carriers, each 7 dB higher than the desired carrier)	BER=10 ⁻⁴ BER=10 ⁻⁶ BER=10 ⁻⁸	Rate 1/2 (B, Q, OQ) 4.5 dB (4.1 dB) 4.7 dB (4.3 dB) 4.9 dB (4.6 dB)	Rate 3/4 (Q, OQ) 5.0 dB (4.6 dB) 5.2 dB (4.8 dB) 5.4 dB (5.0 dB)	Rate 7/8 (Q, OQ) 5.9 dB (5.5 dB) 6.1 dB (5.7 dB) 6.3 dB (5.9 dB)

TURBO PRODUCT CODEC BER	For BER=10 ^{-x}	Rate – Guaranteed Eb/No (typical value in parentheses)		
		Rate 21/44 (B, Q, OQ)*	Rate 5/16 (B)	
Rate 21/44 B/Q/OQPSK Rate 5/16 BPSK (With two adjacent carriers, each 7 dB higher than the desired carrier)	BER=10 ⁻⁶ BER=10 ⁻⁷ BER=10 ⁻⁸	3.1 dB (2.9 dB) 3.3 dB (3.1 dB) 3.5 dB (3.3 dB) * See Notes 1 and 2	2.7 dB (2.5dB) 2.9 dB (2.7dB) 3.1 dB (2.9dB)	
TURBO PRODUCT CODEC BER Rate 3/4 QPSK Rate 3/4 8PSK/8-QAM Rate 3/4 16-QAM (With two adjacent carriers, each 7 dB higher than the desired carrier)	BER=10 ⁻⁶ BER=10 ⁻⁷ BER=10 ⁻⁸	Rate 3/4 (Q, OQ) 3.8dB (3.4dB) 4.1dB (3.7dB) 4.4dB (4.0dB)	Rate 3/4 (8PSK, 8-QAM) 6.4 dB (6.0 dB) 6.7 dB (6.3 dB) 7.1 dB (6.7 dB)	Rate 3/4 (16-QAM) 7.8 dB (7.4 dB) 8.1 dB (7.7 dB) 8.5 dB (8.2 dB)
TURBO PRODUCT CODEC BER Rate 7/8 QPSK Rate 7/8 8PSK/8-QAM Rate 7/8 16-QAM (With two adjacent carriers, each 7 dB higher than the desired carrier)	BER=10 ⁻⁵ BER=10 ⁻⁸	Rate – Guaranteed Eb/No (typical value in parentheses) Rate 7/8 (Q, OQ) 4.3 dB (4.0 dB) 4.5 dB (4.2 dB)	Rate 7/8 (8PSK, 8-QAM) 7.0 dB (6.7 dB) 7.2 dB (6.8 dB)	Rate 7/8 (16-QAM) 8.1 dB (7.7 dB) 8.4 dB (8.1 dB)
TURBO PRODUCT CODEC BER Rate 0.95 QPSK Rate 0.95 8PSK/8-QAM (With two adjacent carriers, each 7 dB higher than the desired carrier)	BER=10 ⁻⁶ BER=10 ⁻⁷ BER=10 ⁻⁸	Rate 0.95 (Q, OQ) 6.4 dB (6.0 dB) 6.7 dB (6.3 dB) 6.9 dB (6.5 dB)	Rate 0.95 (8PSK, 8-QAM) 9.6 dB (9.2 dB) 10.1 dB (9.7 dB) 10.6 dB (10.2 dB)	
LDPC CODEC BER Rate 1/2 B/Q/OQPSK Rate 2/3 Q/OQPSK Rate 1/2 Q/OQPSK (With two adjacent carriers, each 7 dB higher than the desired carrier)	BER=10 ⁻⁵ BER=10 ⁻⁹	Rate 1/2 LDPC BPSK/QPSK/OQPSK* 2.0 dB (1.7 dB) 2.3 dB (2.0 dB) * See Note 2	Rate 2/3 LDPC QPSK/OQPSK 2.3 dB (2.0 dB) 2.7 dB (2.3 dB)	QPSK/OQPSK Rate 3/4 LDPC 3.0 dB (2.6 dB) 3.3 dB (3.0 dB)
LDPC CODEC BER Rate 2/3 8PSK Rate 3/4 8PSK (With two adjacent carriers, each 7 dB higher than the desired carrier)	BER=10 ⁻⁵ BER=10 ⁻⁹	Rate – Guaranteed Eb/No (typical value in parentheses) 8PSK Rate 2/3 LDPC --- 5.7 dB (5.2 dB)	8PSK Rate 3/4 LDPC 5.6 dB (5.2 dB) 6.0 dB (5.6 dB)	
LDPC CODEC BER Rate 2/3 8-QAM Rate 3/4 8-QAM (With two adjacent carriers, each 7 dB higher than the desired carrier)	BER=10 ⁻⁵ BER=10 ⁻⁹	Rate 2/3 LDPC 8-QAM 4.6 dB (4.2 dB) 5.0 dB (4.6 dB)	Rate 3/4 LDPC 8-QAM 5.6 dB (5.2 dB) 6.0 dB (5.6 dB)	
LDPC CODEC BER Rate 3/4 16-QAM (With two adjacent carriers, each 7 dB higher than the desired carrier)	BER=10 ⁻⁵ BER=10 ⁻⁹	Rate 3/4 LDPC 16-QAM 6.8 dB (6.2 dB) 7.1 dB (6.8 dB)		
VersaFEC CODEC BER BPSK (With two adjacent carriers, each 7 dB higher than the desired carrier)	BER=10 ⁻⁵ BER=10 ⁻⁸	Rate 0.488 2.4 dB (2.1 dB) 2.7 dB (2.4 dB)		

VersaFEC CODEC BER QPSK (With two adjacent carriers, each 7 dB higher than the desired carrier)	For BER=10 ^{-x}	Rate – Guaranteed Eb/No (typical value in parentheses)			
	BER=10 ⁻⁵ BER=10 ⁻⁸	Rate 0.533 QPSK 2.3 dB (2.0 dB) 2.5 dB (2.2 dB)	Rate 0.631 QPSK 2.8 dB (2.5 dB) 3.0 dB (2.7 dB)	Rate 0.706 QPSK 3.3 dB (3.0 dB) 3.7 dB (3.4 dB)	Rate 0.803 QPSK 3.8 dB (3.5 dB) 4.1 dB (3.8 dB)
VersaFEC CODEC BER 8-QAM (With two adjacent carriers, each 7 dB higher than the desired carrier)	BER=10 ⁻⁵ BER=10 ⁻⁸	Rate 0.642 8-QAM 4.6 dB (4.3 dB) 4.9 dB (4.6 dB)	Rate 0.711 8-QAM 5.2 dB (4.9 dB) 5.5 dB (5.2 dB)	Rate 0.780 8-QAM 5.6 dB (5.3 dB) 6.0 dB (5.7 dB)	
VersaFEC CODEC BER 16-QAM (With two adjacent carriers, each 7 dB higher than the desired carrier)	BER=10 ⁻⁵ BER=10 ⁻⁸	Rate 0.731 16-QAM 6.6 dB (6.3 dB) 6.8 dB (6.5 dB)	Rate 0.780 16-QAM 7.1 dB (6.8 dB) 7.4 dB (7.1 dB)	Rate 0.829 16-QAM 7.7 dB (7.4 dB) 8.0 dB (7.7 dB)	Rate 0.853 16-QAM 8.1 dB (7.8 dB) 8.4 dB (8.1 dB)
VersaFEC CODEC – Extended CCM (ECCM) BER (With two adjacent carriers, each 7 dB higher than the desired carrier)	BER=10 ⁻⁵ BER=10 ⁻⁸	Rate 0.576 8-QAM 4.5 dB (4.2 dB) 4.9 dB (4.6 dB)	Rate 0.644 16-QAM 6.4 dB (6.1 dB) 6.9 dB (6.6 dB)		
VersaFEC-2 Long Block CODEC BER BPSK (With two adjacent carriers, each 7 dB higher than the desired carrier)	BER=10 ⁻⁴ BER=10 ⁻⁸	Rate 0.489 BPSK 1.8 dB (1.5 dB) 2.1 dB (1.8 dB)			
VersaFEC-2 Long Block CODEC BER QPSK (With two adjacent carriers, each 7 dB higher than the desired carrier)	BER=10 ⁻⁴ BER=10 ⁻⁸	Rate 0.489 QPSK 1.7 dB (1.4 dB) 1.9 dB (1.6 dB)	Rate 0.537 QPSK 1.8 dB (1.5 dB) 2.0 dB (1.7 dB)	Rate 0.586 QPSK 2.0 dB (1.7 dB) 2.2 dB (1.9 dB)	Rate 0.611 QPSK 2.1 dB (1.8 dB) 2.2 dB (1.9 dB)
	BER=10 ⁻⁴ BER=10 ⁻⁸	Rate 0.635 QPSK 2.3 dB (2.0 dB) 2.5 dB (2.2 dB)	Rate 0.660 QPSK 2.4 dB (2.1 dB) 2.6 dB (2.3 dB)	Rate 0.684 QPSK 2.4 dB (2.1 dB) 2.6 dB (2.3 dB)	Rate 0.733 QPSK 2.8 dB (2.5 dB) 3.0 dB (2.7 dB)
VersaFEC-2 Long Block CODEC BER 8-ARY (With two adjacent carriers, each 7 dB higher than the desired carrier)	BER=10 ⁻⁴ BER=10 ⁻⁸	Rate 0.521 8-ARY 3.2 dB (2.9 dB) 3.5 dB (3.2 dB)	Rate 0.537 8-ARY 3.2 dB (2.9 dB) 3.6 dB (3.3 dB)	Rate 0.562 8-ARY 3.3 dB (3.0 dB) 3.6 dB (3.6 dB)	Rate 0.586 8-ARY 3.3 dB (3.0 dB) 3.6 dB (3.6 dB)
	BER=10 ⁻⁴ BER=10 ⁻⁸	Rate 0.611 8-ARY 3.4 dB (3.1 dB) 3.7 dB (3.4 dB)	Rate 0.635 8-ARY 3.5 dB (3.2 dB) 3.7 dB (3.4 dB)	Rate 0.660 8-ARY 3.7 dB (3.4 dB) 3.8 dB (3.5 dB)	Rate 0.684 8-ARY 3.9 dB (3.6 dB) 4.1 dB (3.8 dB)
	BER=10 ⁻⁴ BER=10 ⁻⁸	Rate 0.708 8-ARY 4.0 dB (3.7 dB) 4.2 dB (3.9 dB)	Rate 0.733 8-ARY 4.3 dB (4.0 dB) 4.4 dB (4.1 dB)		
VersaFEC-2 Long Block CODEC BER 16-ARY (With two adjacent carriers, each 7 dB higher than the desired carrier)	BER=10 ⁻⁴ BER=10 ⁻⁸	Rate 0.586 16-ARY 4.4 dB (4.1 dB) 4.7 dB (4.4 dB)	Rate 0.611 16-ARY 4.7 dB (4.4 dB) 5.0 dB (4.7 dB)	Rate 0.635 16-ARY 4.9 dB (4.6 dB) 5.2 dB (4.9 dB)	Rate 0.660 16-ARY 5.1 dB (4.8 dB) 5.3 dB (5.0 dB)
	BER=10 ⁻⁴ BER=10 ⁻⁸	Rate 0.684 16-ARY 5.3 dB (5.0 dB) 5.5 dB (5.2 dB)	Rate 0.708 16-ARY 5.6 dB (5.3 dB) 5.8 dB (5.5 dB)	Rate 0.733 16-ARY 5.9 dB (5.6 dB) 6.1 dB (5.8 dB)	Rate 0.757 16-ARY 6.2 dB (5.9 dB) 6.4 dB (6.1 dB)
	BER=10 ⁻⁴ BER=10 ⁻⁸	Rate 0.782 16-ARY 6.5 dB (6.2 dB) 6.7 dB (6.4 dB)			
VersaFEC-2 Long Block CODEC BER 32-ARY (With two adjacent carriers, each 7 dB higher than the desired carrier)	BER=10 ⁻⁴ BER=10 ⁻⁸	Rate 0.660 32-ARY 6.8 dB (6.5 dB) 7.1 dB (6.8 dB)	Rate 0.684 32-ARY 7.2 dB (6.9 dB) 7.5 dB (7.2 dB)	Rate 0.708 32-ARY 7.4 dB (7.1 dB) 7.7 dB (7.4 dB)	Rate 0.733 32-ARY 7.7 dB (7.4 dB) 8.0 dB (7.7 dB)
	BER=10 ⁻⁴ BER=10 ⁻⁸	Rate 0.757 32-ARY 8.0 dB (7.7 dB) 8.2 dB (7.9 dB)	Rate 0.782 32-ARY 8.4 dB (8.1 dB) 8.6 dB (8.3 dB)	Rate 0.801 32-ARY 8.8 dB (8.5 dB) 9.0 dB (8.7 dB)	Rate 0.831 32-ARY 9.1 dB (8.8 dB) 9.3 dB (9.0 dB)
	BER=10 ⁻⁴ BER=10 ⁻⁸	Rate 0.855 32-ARY 9.8 dB (9.5 dB) 10.0 dB (9.7 dB)	Rate 0.879 32-ARY 10.4 dB (10.1 dB) 10.6 dB (10.3 dB)		

VersaFEC-2 Short Block CODEC BER BPSK (With two adjacent carriers, each 7 dB higher than the desired carrier)	For BER=10 ^{-x}	Rate – Guaranteed Eb/No (typical value in parentheses)			
	BER=10 ⁻⁴ BER=10 ⁻⁸	Rate 0.489 BPSK 2.6 dB (2.3 dB) 3.2 dB (2.9 dB)			
VersaFEC-2 Short Block CODEC BER QPSK (With two adjacent carriers, each 7 dB higher than the desired carrier)	BER=10 ⁻⁴ BER=10 ⁻⁸	Rate 0.489 QPSK 2.3 dB (1.4 dB) 2.7 dB (1.6 dB)	Rate 0.537 QPSK 2.4 dB (2.1 dB) 2.0 dB (1.7 dB)	Rate 0.586 QPSK 2.5 dB (2.2 dB) 3.0 dB (2.7 dB)	Rate 0.611 QPSK 2.6 dB (2.3 dB) 3.1 dB (2.8 dB)
	BER=10 ⁻⁴ BER=10 ⁻⁸	Rate 0.635 QPSK 2.8 dB (2.5 dB) 3.2 dB (2.9 dB)	Rate 0.660 QPSK 2.9 dB (2.6 dB) 3.3 dB (3.0 dB)	Rate 0.684 QPSK 3.0 dB (2.7 dB) 3.4 dB (3.1 dB)	Rate 0.733 QPSK 3.4 dB (3.1 dB) 3.8 dB (3.5 dB)
VersaFEC-2 Short Block CODEC BER 8-ARY (With two adjacent carriers, each 7 dB higher than the desired carrier)	BER=10 ⁻⁴ BER=10 ⁻⁸	Rate 0.521 8-ARY 3.5 dB (3.2 dB) 4.0 dB (3.7 dB)	Rate 0.537 8-ARY 3.5 dB (3.2 dB) 4.1 dB (3.8 dB)	Rate 0.562 8-ARY 3.6 dB (3.6 dB) 4.2 dB (3.9 dB)	Rate 0.586 8-ARY 3.7 dB (3.4 dB) 4.2 dB (3.9 dB)
	BER=10 ⁻⁴ BER=10 ⁻⁸	Rate 0.611 8-ARY 3.9 dB (3.6 dB) 4.3 dB (4.0 dB)	Rate 0.635 8-ARY 3.9 dB (3.6 dB) 4.4 dB (4.1 dB)	Rate 0.660 8-ARY 4.1 dB (3.8 dB) 4.5 dB (4.2 dB)	Rate 0.684 8-ARY 4.4 dB (4.1 dB) 4.7 dB (4.4 dB)
	BER=10 ⁻⁴ BER=10 ⁻⁸	Rate 0.708 8-ARY 4.5 dB (4.2 dB) 4.8 dB (4.5 dB)	Rate 0.733 8-ARY 4.8 dB (4.5 dB) 5.2 dB (4.9 dB)		
VersaFEC-2 Short Block CODEC BER 16-ARY (With two adjacent carriers, each 7 dB higher than the desired carrier)	BER=10 ⁻⁴ BER=10 ⁻⁸	Rate 0.586 16-ARY 4.8 dB (4.5 dB) 5.3 dB (5.0 dB)	Rate 0.611 16-ARY 5.0 dB (4.7 dB) 5.4 dB (5.1 dB)	Rate 0.635 16-ARY 5.3 dB (5.0 dB) 5.6 dB (5.3 dB)	Rate 0.660 16-ARY 5.5 dB (5.2 dB) 5.8 dB (5.5 dB)
	BER=10 ⁻⁴ BER=10 ⁻⁸	Rate 0.684 16-ARY 5.7 dB (5.4 dB) 6.2 dB (5.9 dB)	Rate 0.708 16-ARY 6.1 dB (5.8 dB) 6.5 dB (6.2 dB)	Rate 0.733 16-ARY 6.2 dB (5.9 dB) 6.6 dB (6.3 dB)	Rate 0.757 16-ARY 6.7 dB (6.4 dB) 7.1 dB (6.8 dB)
	BER=10 ⁻⁴ BER=10 ⁻⁸	Rate 0.782 16-ARY 7.0 dB (6.7 dB) 7.5 dB (7.2 dB)			
VersaFEC-2 Short Block CODEC BER 32-ARY (With two adjacent carriers, each 7 dB higher than the desired carrier)	BER=10 ⁻⁴ BER=10 ⁻⁸	Rate 0.660 32-ARY 7.3 dB (7.0 dB) 7.9 dB (7.6 dB)	Rate 0.684 32-ARY 7.5 dB (7.2 dB) 8.1 dB (7.8 dB)	Rate 0.708 32-ARY 7.7 dB (7.4 dB) 8.2 dB (7.9 dB)	Rate 0.733 32-ARY 8.2 dB (7.9 dB) 8.7 dB (8.4 dB)
	BER=10 ⁻⁴ BER=10 ⁻⁸	Rate 0.757 32-ARY 8.4 dB (8.1 dB) 8.9 dB (8.6 dB)	Rate 0.782 32-ARY 8.7 dB (8.4 dB) 9.2 dB (8.9 dB)	Rate 0.801 32-ARY 9.1 dB (8.8 dB) 9.5 dB (9.2 dB)	Rate 0.831 32-ARY 9.5 dB (9.2 dB) 9.9 dB (9.6 dB)
Ultra-Low-Latency (ULL) CODEC BER (With two adjacent carriers, each 7 dB higher than the desired carrier)	BER=10 ⁻⁵ BER=10 ⁻⁸	Rate 0.493 BPSK 3.1 dB (2.8 dB) 3.7 dB (3.4 dB)	Rate 0.493 QPSK 3.1 dB (2.8 dB) 3.7 dB (3.4 dB)	Rate 0.654 QPSK 3.6 dB (3.3 dB) 4.2 dB (3.9 dB)	Rate 0.734 QPSK 4.1 dB (3.8 dB) 4.7 dB (4.4 dB)

Notes:

- 1) Rate 21/44 QPSK is shown as Rate 1/2 on the Front Panel display, etc.
- 2) The demod acquisition and tracking threshold for OQPSK is approx 1 dB worse than the QPSK case in this mode.

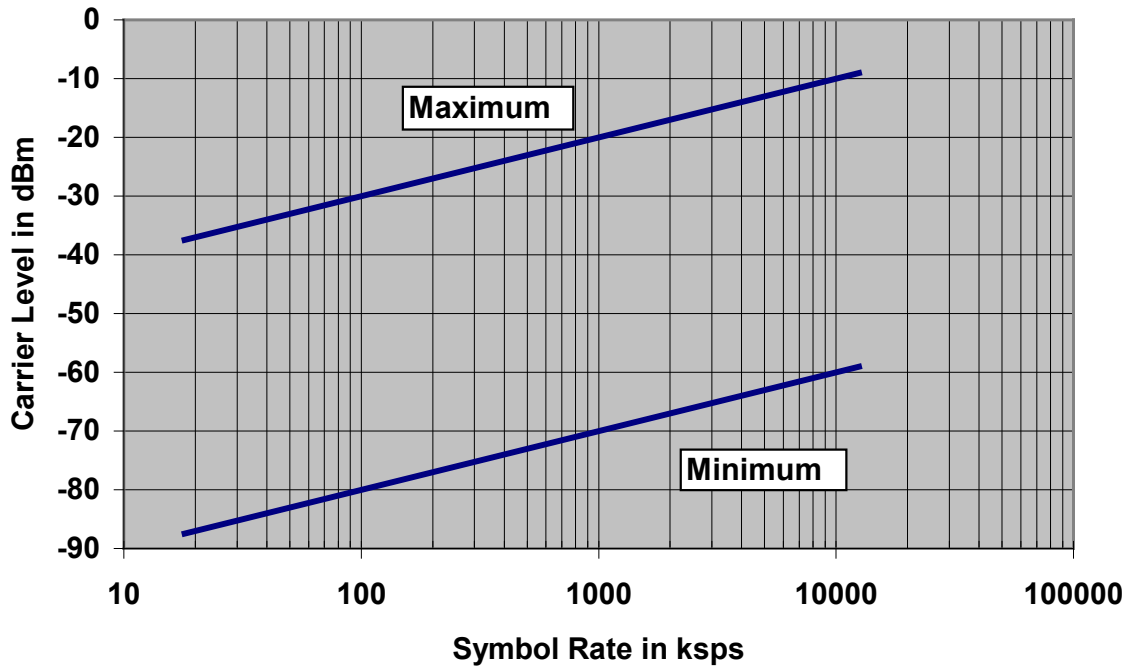

Figure 1-5. Rx Carrier Level vs. Symbol Rate – L-Band (950-2250 MHz)

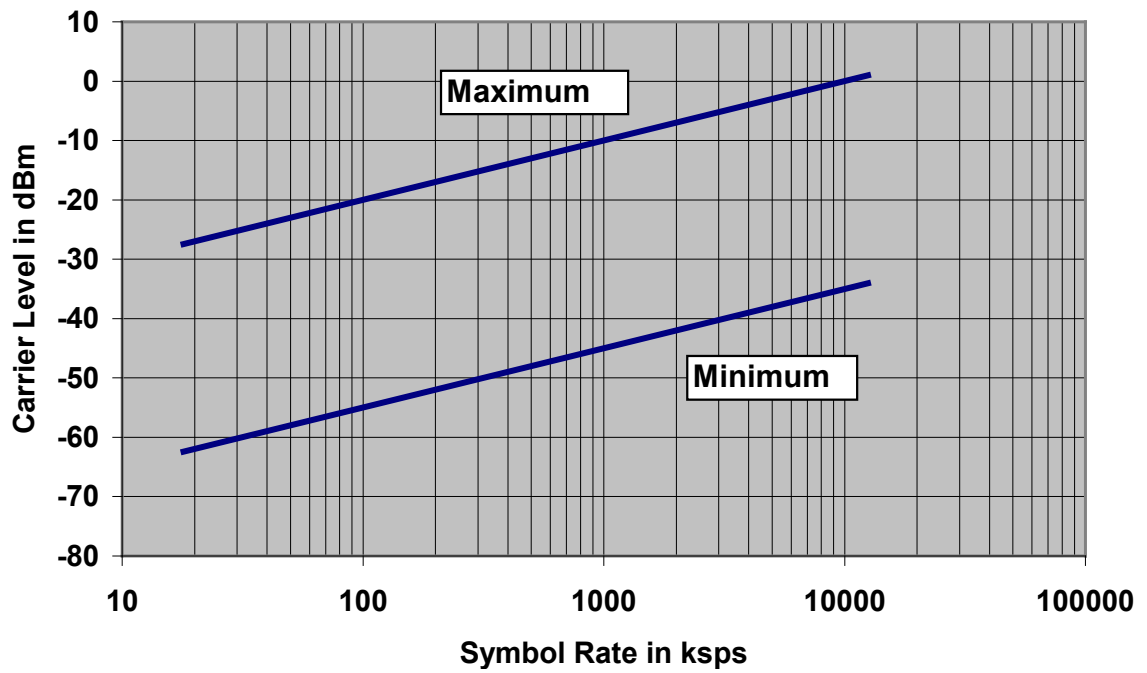

Figure 1-6. Rx Carrier Level vs. Symbol Rate – IF Band (50-180 MHz)

1.4.3 Data Interfaces

Primary Data (4 selectable modes)	RS-422/EIA-530 DCE (Rates up to 14 Mbps) (also supports X.21 DCE & DTE up to 2.048 Mbps and 8k ESC orderwire for IDR) V.35 DCE (Rates up to 14 Mbps) LVDS serial (Rates up to 25 Mbps) HSSI serial (Rates up to 25 Mbps)	25-pin D-sub (female)
G.703 (Tx In, Drop Out, Insert In, Rx Out)	1.544 Mbps T1 (Balanced 100 Ω) 6.312 Mbps T2 (unbalanced 75 Ω or balanced 110 Ω) 2.048 Mbps E1 (unbalanced 75 Ω or balanced 120 Ω) 8.448 Mbps E2 (unbalanced 75 Ω) Note: All Drop and Insert modes are a FAST option.	9-pin D-sub (female) or BNC (female)
ASI	Uses G.703 (Tx In, Rx Out) ports	BNC (female)
Auxiliary G.703 (used for Quad D&I modes)	Two additional 2.048 Mbps E1 ports (balanced 120 Ω) Note: All Drop and Insert modes are a FAST option.	9-pin D-sub (female)
External Reference In/Out	As an input: 1, 2, 5 or 10MHz -6dBm to +10dBm (nominal 50/75 Ω) As an output: 10MHz, 2.7 volts peak-to-peak +/- 0.4 volts, low impedance output	BNC (female)
Overhead Data IDR BWA Inputs/Outputs ADPCM Audio Interface	RS-422 octet clocks for IDR ESC & IBS RS-422 IDR 64 kbps ESC data & clock IDR BWA Inputs/4 backward alarm Form C relay outputs 2 audio channels, each occupying 32 kbps bandwidth as part of IDR overhead or as a 64 kbps primary data rate option. 600 Ω balanced – 0 dBm0 nominal, -6 to +8 dB, 2 dB steps	44-pin High-density D-sub (male)
Modem Alarms	Relay outputs (Tx, Rx & unit faults) Demodulator I & Q test outputs (constellation) Demodulator Rx Signal Level output (0 to 2.5 volts) External carrier off input	15-pin D-sub (male)
ESC (Overhead)	Standard IBS ESC interfaces RS-232/485 High Rate ESC data RS-232/485 ESC++ data	9-pin D-sub (female)
Remote Control	RS-232 or RS-485 modem control and monitoring	9-pin D-sub (male)
PMSI Interface	Pre-mapped Symbol interface (used by DoubleTalk Carrier-in-Carrier function)	9-pin D-sub (female)
1:1 Control	Control interface for CRS170A/CRS180 1:1 Redundancy unit	9-pin D-sub (male)
Ethernet	4 ports of 10/100 BaseT auto-sensing full/half duplex Ethernet	RJ-45

1.4.4 Automatic Uplink Power Control (AUPC)

Operating Mode	Requires Closed Network Framed mode (EDMAC, D&I++, Enhanced D&I, or ESC++) for transport of Eb/No information from remote modem (EDMAC can be enabled or disabled)
Target Eb/No range	0 to 14.9 dB at remote demod (default is 4.0 dB)
Max AUPC range	0 to 9 dB (default is 3 dB)
Monitor functions	Remote demod Eb/No Tx power level increase (front panel or via remote control interface)

1.4.5 DoubleTalk® Carrier- in-Carrier® (CnC)

Operating Mode	Requires the two links to share a common carrier frequency (Outbound and Inbound symbol rates do not have to be equal)
Power Spectral Density Ratio and CnC Ratio	<p>BSPK/QPSK/8PSK/8-QAM: -7 dB to +11 dB (ratio of power spectral density, outbound interferer to desired inbound)</p> <p>16-QAM: -7 dB to +7 dB (ratio of power spectral density, outbound interferer to desired inbound)</p> <p>Note: With asymmetric carriers, the absolute power ratio (or CnC ratio) would be different, depending on the ratio of the symbol rates.</p> <p>Example: Outbound interferer = 1 Msymbols/sec Desired Inbound = 500 ksymbols/sec Ratio of power spectral density = +7 dB Absolute power ratio (CnC Ratio) = +7dB + (10 log Outbound/desired symbol rate) = +10 dB</p>
Maximum Symbol Rate Ratio	3:1 (TX:RX or RX:TX)
Inbound/Outbound frequency uncertainty	<p>Within the normal acquisition range of the demod, as follows:</p> <p>Below 64 ksymbols/sec: ±1 to ±(Rs/2) kHz, where Rs = symbol rate in ksymbols/sec</p> <p>Between 64 and 389 ksymbols/sec: ±1 up to a maximum of ±32kHz</p> <p>Above 389 ksymbols/sec: ±1 to ±(0.1Rs) kHz, up to a maximum of ±200 kHz</p>
Delay range	0-330 ms
Eb/No Degradation (equal Inbound/Outbound power spectral density)	<p>BPSK = 0.3dB QPSK = 0.3dB OQPSK = 0.3dB 8PSK = 0.5dB 8-QAM = 0.4dB 16-QAM = 0.6dB</p> <p>For +10 dB power spectral density ratio (outbound interferer 10 dB higher than desired inbound) add an additional 0.3 dB</p>
Monitor Functions	<p>Delay, in milliseconds</p> <p>Frequency offset (between outbound interferer and desired inbound). 100 Hz resolution</p> <p>CnC Power Ratio, in 0.1 dB (ratio of absolute power, outbound interferer to desired inbound)</p> <p>Power Spectral Density Ratio, in 0.1 dB</p>
CnC Monitor Accuracy	±0.2 dB for symmetric symbol rate

1.4.6 Framing Summary

Framing Mode	Overhead added	Available data rates and format	Overhead components	Additional Reed-Solomon Overhead	Scrambling (see Note 1)
Transparent	None	All rates and formats	None	200/220 225/205 219/201 126/112	Basic ITU V.35 (Intelsat)
EDMAC	To 2 Mbps: 5% Above 2 Mbps: 1.6% (see Note 2)	All rates and formats	Remote control link between modems' processor plus AUPC	200/180	Proprietary scrambler
EDMAC-2	1.6%	All rates and formats	Remote control link between modems' processor plus AUPC	200/180	Proprietary scrambler
EDMAC-3	To 2 Mbps: 5% Above 2 Mbps: 1.6%	All rates and formats	Remote control link between modems' processor plus AUPC	200/180	Proprietary scrambler
IDR	Fixed 96 kHz	T1, E1, T2 and E2; all formats	EIA-422 ESC (8 kbps) EIA-422 ESC (64 kbps or 2 audio links) 4 BW alarms	T1 = 225/205 E1 = 219/201 and IESS-310 mode T2/E2 = 194/178	Basic ITU V.35 (Intelsat)
IBS	1/15 of front panel data rate	64 to 2048 kbps only; all formats	EIA-232 Earth station link at 1/480 th of primary data rate. One BW alarm	126/112 219/201 for IESS-310 mode	IESS-309 scrambler
D&I	1/15 of front panel data rate Terrestrial is T1 or E1	Specific multiples of 64 kbps only	EIA-232 Earth station link at 1/480 th of primary data rate One BW alarm	126/112 219/201 for IESS-310 mode	IESS-309 scrambler
D&I++	1/45 of front panel data rate Terrestrial is T1 or E1	Any multiple of 64 kbps, up to n = 31	Same as EDMAC, plus EIA-232 Earth station link at 1/576 th of primary data rate	126/112	Basic ITU V.35 (Intelsat)
ESC++	Variable: between 11.76% at 64 kbps to 1.58% above 7 Mbps	All rates and formats	EIA-232 Earth station link at variable rate, plus AUPC	126/112	Basic ITU V.35 (Intelsat)
QDI	0.78% (129/128) of front panel data rate	n x 64 kbps, up to n = 128 using a max of 4 balanced G.703 E1 D&I interfaces	None	220/200 225/205 219/201	Basic ITU V.35 (Intelsat)
Framed QDI	Concatenation of QDI and EDMAC-2	n x 64 kbps, up to n = 128 using a max of 4 balanced G.703 E1 D&I interfaces	None	200/180	Basic ITU V.35 (Intelsat)

Notes:

- 1) Reed-Solomon is Off.
- 2) % for Rates 5/16 or 21/44 BPSK Turbo, Rate 1/2 QPSK/OQPSK Turbo, and all rates > 2 Mbps.

1.4.7 Data Rate Ranges

UNFRAMED (NO REED SOLOMON)	Lower Limit (kbps)	Upper Limit (kbps)
No FEC, BPSK	18.0	12500
No FEC, O/QPSK	36.0	25000.0
VITERBI, BPSK, 1/2	18.0	6250.0
VITERBI, O/QPSK, 1/2	18.0	12500.0
VITERBI, O/QPSK, 3/4	27.0	18750.0
VITERBI, O/QPSK, 7/8	31.5	21875.0
SEQUENTIAL, BPSK, 1/2	18.0	1024.0
SEQUENTIAL, O/QPSK, 1/2	18.0	2048.0
SEQUENTIAL, O/QPSK, 3/4	27.0	2048.0
SEQUENTIAL, O/QPSK, 7/8	31.5	2048.0
TRELLIS, 8PSK, 2/3	36.0	25000.0
TPC, BPSK, 5/16	18.0	3906.2
TPC, BPSK, 21/44 (aka 1/2)	18.0	5965.9
TPC, O/QPSK, 21/44 (aka 1/2)	18.0	11931.8
TPC, O/QPSK, 3/4	27.0	18750.0
TPC, O/QPSK, 17/18 (aka 0.95)	34.2	23611.1
TPC, O/QPSK, 7/8	31.5	21875.0
TPC, 8PSK/8-QAM, 3/4	40.5	25000.0
TPC, 8PSK/8-QAM, 17/18 (aka 0.95)	52.0	25000.0
TPC, 8PSK/8-QAM, 7/8	48.0	25000.0
TPC, 16-QAM, 3/4	54.0	25000.0
TPC, 16-QAM, 7/8	63.0	25000.0
LDPC, BPSK, 1/2	18.0	6250.0
LDPC, O/QPSK, 1/2	18.0	12500.0
LDPC, O/QPSK, 3/4	27.0	18750.0
LDPC, O/QPSK, 2/3	24.0	16666.6
LDPC, 8PSK/8-QAM, 3/4	40.5	25000.0
LDPC, 8PSK/8-QAM, 2/3	36.0	25000.0
LDPC, 16-QAM, 3/4	54.0	25000.0

UNFRAMED (ANY REED SOLOMON)	Lower Limit (kbps)	Upper Limit (kbps)
VITERBI, BPSK, 1/2	18.0	5555.0
VITERBI, O/QPSK, 1/2	18.0	11111.0
VITERBI, O/QPSK, 3/4	27.0	16666.6
VITERBI, O/QPSK, 7/8	31.5	19444.0
SEQUENTIAL, BPSK, 1/2	18.0	1024.0
SEQUENTIAL, O/QPSK, 1/2	18.0	2048.0
SEQUENTIAL, O/QPSK, 3/4	29.0	2048.0
SEQUENTIAL, O/QPSK, 7/8	31.5	2048.0
TRELLIS, 8PSK, 2/3	36.0	22222.0
VIT 16-QAM, 3/4	54.0	22222.0
VIT 16-QAM, 7/8	63.0	22222.0

EDMAC, EDMAC-2, or EDMAC-3 (NO REED SOLOMON)	Lower Limit (kbps)	Upper Limit (kbps)
No FEC, BPSK	18.0	12295.0
No FEC, O/QPSK	35.5	24590.1
VITERBI, BPSK, 1/2	18.0	6147.5
VITERBI, O/QPSK, 1/2	18.0	12295.0
VITERBI, O/QPSK, 3/4	26.6	18442.6
VITERBI, O/QPSK, 7/8	31.0	21516.3
SEQUENTIAL, BPSK, 1/2	18.0	1024.0
SEQUENTIAL, O/QPSK, 1/2	18.0	2048.0
SEQUENTIAL, O/QPSK, 3/4	26.6	2048.0
SEQUENTIAL, O/QPSK, 7/8	31.0	2048.0
TRELLIS, 8PSK, 2/3	35.5	24590.1
TPC, BPSK, 5/16	18.0	3842.2
TPC, BPSK, 21/44 (aka 1/2)	18.0	5868.1
TPC, O/QPSK, 21/44 (aka 1/2)	18.0	11736.2
TPC, O/QPSK, 3/4	26.6	18442.6
TPC, O/QPSK, 17/18 (aka 0.95)	33.5	23224.0
TPC, O/QPSK, 7/8	31.0	21516.3
TPC, 8PSK/8-QAM, 3/4	39.9	24590.1
TPC, 8PSK/8-QAM, 17/18 (aka 0.95)	50.2	24590.1
TPC, 8PSK/8-QAM, 7/8	46.5	24590.1
TPC, 16-QAM, 3/4	53.2	24590.1
TPC, 16-QAM, 7/8	62.0	24590.1
LDPC, BPSK, 1/2	18.0	6147.5
LDPC, O/QPSK, 1/2	18.0	12295.0
LDPC, O/QPSK, 3/4	26.6	18442.6
LDPC, O/QPSK, 2/3	23.7	16393.4
LDPC, 8PSK/8-QAM, 3/4	39.9	24590.1
LDPC, 8PSK/8-QAM, 2/3	35.5	24590.1
LDPC, 16-QAM, 3/4	53.2	24590.1

EDMAC, EDMAC-2, or EDMAC-3 (ANY REED SOLOMON)	Lower Limit (kbps)	Upper Limit (kbps)
VITERBI, BPSK, 1/2	18.0	5532.7
VITERBI, O/QPSK, 1/2	18.0	11065.5
VITERBI, O/QPSK, 3/4	24.0	16598.3
VITERBI, O/QPSK, 7/8	27.9	19364.7
SEQUENTIAL, BPSK, 1/2	18.0	1024.0
SEQUENTIAL, O/QPSK, 1/2	18.0	2048.0
SEQUENTIAL, O/QPSK, 3/4	24.0	2048.0
SEQUENTIAL, O/QPSK, 7/8	27.9	2048.0
TRELLIS, 8PSK, 2/3	31.9	22131.1
VIT 16-QAM, 3/4	47.9	22131.1
VIT 16-QAM, 7/8	55.8	22131.1

IBS (NO REED SOLOMON)	Lower Limit (kbps)	Upper Limit (kbps)
No FEC, BPSK	64.0	8448.0
No FEC, O/QPSK	64.0	8448.0
VITERBI, BPSK, 1/2	64.0	5859.3
VITERBI, O/QPSK, 1/2	64.0	8448.0
VITERBI, O/QPSK, 3/4	64.0	8448.0
VITERBI, O/QPSK, 7/8	64.0	8448.0
SEQUENTIAL, BPSK, 1/2	64.0	1024.0
SEQUENTIAL, O/QPSK, 1/2	64.0	2048.0
SEQUENTIAL, O/QPSK, 3/4	64.0	2048.0
SEQUENTIAL, O/QPSK, 7/8	64.0	2048.0
TRELLIS, 8PSK, 2/3	64.0	8448.0
TPC, BPSK, 5/16	64.0	3662.1
TPC, BPSK, 21/44 (aka 1/2)	64.0	5593.0
TPC, O/QPSK, 21/44 (aka 1/2)	64.0	8448.0
TPC, O/QPSK, 3/4	64.0	8448.0
TPC, O/QPSK, 17/18 (aka 0.95)	64.0	8448.0
TPC, O/QPSK, 7/8	64.0	8448.0
TPC, 8PSK/8-QAM, 3/4	64.0	8448.0
TPC, 8PSK/8-QAM, 17/18 (aka 0.95)	64.0	8448.0
TPC, 8PSK/8-QAM, 7/8	64.0	8448.0
TPC, 16-QAM, 3/4	64.0	8448.0
TPC, 16-QAM, 7/8	64.0	8448.0
LDPC, BPSK, 1/2	64.0	5859.3
LDPC, O/QPSK, 1/2	64.0	8448.0
LDPC, O/QPSK, 3/4	64.0	8448.0
LDPC, O/QPSK, 2/3	64.0	8448.0
LDPC, 8PSK/8-QAM, 3/4	64.0	8448.0
LDPC, 8PSK/8-QAM, 2/3	64.0	8448.0
LDPC, 16-QAM, 3/4	64.0	8448.0

IBS (ANY REED SOLOMON)	Lower Limit (kbps)	Upper Limit (kbps)
VITERBI, BPSK, 1/2	64.0	5208.0
VITERBI, O/QPSK, 1/2	64.0	8448.0
VITERBI, O/QPSK, 3/4	64.0	8448.0
VITERBI, O/QPSK, 7/8	64.0	8448.0
SEQUENTIAL, BPSK, 1/2	64.0	1024.0
SEQUENTIAL, O/QPSK, 1/2	64.0	2048.0
SEQUENTIAL, O/QPSK, 3/4	64.0	2048.0
SEQUENTIAL, O/QPSK, 7/8	64.0	2048.0
TRELLIS, 8PSK, 2/3	64.0	8448.0
VIT 16-QAM, 3/4	64.0	8448.0
VIT 16-QAM, 7/8	64.0	8448.0

ESC++ (NO REED SOLOMON)	Lower Limit (kbps)	Upper Limit (kbps)
No FEC, BPSK	64.0	12304.6
No FEC, O/QPSK	64.0	24609.3
VITERBI, BPSK, 1/2	64.0	5921.0
VITERBI, O/QPSK, 1/2	64.0	12304.6
VITERBI, O/QPSK, 3/4	64.0	18457.0
VITERBI, O/QPSK, 7/8	64.0	21533.2
SEQUENTIAL, BPSK, 1/2	64.0	1024.0
SEQUENTIAL, O/QPSK, 1/2	64.0	2048.0
SEQUENTIAL, O/QPSK, 3/4	64.0	2048.0
SEQUENTIAL, O/QPSK, 7/8	64.0	2048.0
TRELLIS, 8PSK, 2/3	64.0	24609.3
TPC, BPSK, 5/16	64.0	3700.6
TPC, BPSK, 21/44 (aka 1/2)	64.0	5651.9
TPC, O/QPSK, 21/44 (aka 1/2)	64.0	11745.3
TPC, O/QPSK, 3/4	64.0	18457.0
TPC, O/QPSK, 17/18 (aka 0.95)	64.0	23242.1
TPC, O/QPSK, 7/8	64.0	21533.2
TPC, 8PSK/8-QAM, 3/4	64.0	24609.3
TPC, 8PSK/8-QAM 17/18 (aka 0.95)	64.0	24609.3
TPC, 8PSK/8-QAM, 7/8	64.0	24609.3
TPC, 16-QAM, 3/4	64.0	24609.3
TPC, 16-QAM, 7/8	64.0	24609.3
LDPC, BPSK, 1/2	64.0	5921.0
LDPC, O/QPSK, 1/2	64.0	12304.6
LDPC, O/QPSK, 3/4	64.0	18457.0
LDPC, O/QPSK, 2/3	64.0	16406.2
LDPC, 8PSK/8-QAM, 3/4	64.0	24609.3
LDPC, 8PSK/8-QAM, 2/3	64.0	24609.3
LDPC, 16-QAM, 3/4	64.0	24609.3

ESC++ (ANY REED SOLOMON)	Lower Limit (kbps)	Upper Limit (kbps)
VITERBI, BPSK, 1/2	64.0	5263.1
VITERBI, O/QPSK, 1/2	64.0	10937.5
VITERBI, O/QPSK, 3/4	64.0	16406.2
VITERBI, O/QPSK, 7/8	64.0	19140.6
SEQUENTIAL, BPSK, 1/2	64.0	1024.0
SEQUENTIAL, O/QPSK, 1/2	64.0	2048.0
SEQUENTIAL, O/QPSK, 3/4	64.0	2048.0
SEQUENTIAL, O/QPSK, 7/8	64.0	2048.0
TRELLIS, 8PSK, 2/3	64.0	21875.0
VITERBI, 16-QAM, 3/4	64.0	21875.0
VITERBI, 16-QAM, 7/8	64.0	21875.0

VersaFEC (ANY MODE)	Lower Limit (kbps)	Upper Limit (kbps)
VersaFEC BPSK Rate 0.488	18.0	5700.0
VersaFEC QPSK Rate 0.533	20.0	10000.0
VersaFEC QPSK Rate 0.631	23.0	10000.0
VersaFEC QPSK Rate 0.706	26.0	10000.0
VersaFEC QPSK Rate 0.803	28.0	12000.0
VersaFEC 8-QAM Rate 0.576 (ECCM)	32.0	11000.0
VersaFEC 8-QAM Rate 0.642	35.0	12000.0
VersaFEC 8-QAM Rate 0.711	39.0	12000.0
VersaFEC 8-QAM Rate 0.780	43.0	12000.0
VersaFEC 16-QAM Rate 0.644 (ECCM)	47.0	11000.0
VersaFEC 16-QAM Rate 0.731	53.0	12000.0
VersaFEC 16-QAM Rate 0.780	57.0	14000.0
VersaFEC 16-QAM Rate 0.829	60.0	14000.0
VersaFEC 16-QAM Rate 0.853	62.0	16000.0
ULL BPSK Rate 0.493	18.0	5700.0
ULL QPSK Rate 0.493	18.0	6000.0
ULL QPSK Rate 0.654	24.0	9000.0
ULL QPSK Rate 0.734	27.0	9000.0

VersaFEC Adaptive Coding and Modulation (ACM): See Sect. 1.4.8.1 Specifications

VersaFEC-2 Adaptive Coding and Modulation (ACM): See Sect. 1.4.8.2 Specifications

1.4.8 VersaFEC Adaptive Coding and Modulation (ACM)

1.4.8.1 VersaFEC ACM

System type	Adaptive Coding and Modulation, using BPSK, QPSK, 8-QAM , 16-QAM and VersaFEC short-block LDPC coding – a total of 12 ModCods					
Symbol Rate Range	37 ksps to 4100 ksps					
Interface	10/100 Base T Ethernet, with auto-negotiated Congestion Control					
Remote SNR reporting	Automatically reported from remote modem – built in function at the physical layer – requires no additional overhead					
Max span of data rate	7:1 over range of adaptation					
Switch point (decreasing SNR)	Corresponds to SNR (Eb/No) that gives BER = 5×10^{-8}					
Switch point hysteresis	0.3 dB					
Max fading rate	Approximately 1 dB/second (higher if Target Eb/No margin > 1 dB)					
Max ModCod update rate	1 update every 2 seconds					
Configurable parameters	Minimum and Maximum ModCod (ModCods 00-11) Remote Demod Unlock Action: Maintain current ModCod Go to minimum ModCod Target Eb/No margin (0 to 4.5 dB, 0.5 dB steps)					
System latency	54 milliseconds maximum (for a system operating at 100 ksps, and assuming a WAN buffer of 20 milliseconds, not including satellite path)					
Monitored parameters	Tx and Rx ModCods Local and Remote SNR (-3.0 dB to +22.0dB, 0.1dB resolution, +/- 0.5 dB accuracy) Config and monitor menus displaying data rate, modulation and code rate update dynamically with ModCod					
ModCod	Modulation	Code Rate	Spectral efficiency, bps/Hz	Typical Eb/No, for BER = 5×10^{-8} (dB)	Min. Data Rate, ACM Mode (kbps)	Max. Data Rate, ACM Mode (Mbps)
00	BPSK	0.488	0.49	2.4	18.1	2.00
01	QPSK	0.533	1.07	2.2	39.6	4.38
02	QPSK	0.631	1.26	2.7	46.7	5.16
03	QPSK	0.706	1.41	3.4	52.2	5.78
04	QPSK	0.803	1.61	3.8	59.6	6.60
05	8-QAM	0.642	1.93	4.6	71.5	7.91
06	8-QAM	0.711	2.13	5.2	78.8	8.73
07	8-QAM	0.780	2.34	5.6	86.6	9.59
08	16-QAM	0.731	2.93	6.5	108.5	12.01
09	16-QAM	0.780	3.12	7.1	115.5	12.79
10	16-QAM	0.829	3.32	7.7	122.8	13.61
11	16-QAM	0.853	3.41	8.1	126.2	14.00

1.4.8.2 VersaFEC-2 ACM

System type	Adaptive Coding and Modulation, using BPSK, QPSK, 8-ARY, 16-ARY, 32-ARY and VersaFEC-2 Short-block and Long Block LDPC coding - total of 74 ModCods
Symbol Rate Range	37 ksps to 12.5 Msps (Long)
Interface	10/100 Base T Ethernet, with auto-negotiated Congestion Control
Remote SNR reporting	Automatically reported from remote modem – built in function at the physical layer – requires no additional overhead
Max span of data rate	9:1 over range of adaptation
Switch point (decreasing SNR)	Corresponds to SNR (Es/No) that gives BER = 1×10^{-8} (margin set to 0 dB)
Switch point hysteresis	0.3 dB
Max fading rate	Approximately 1 dB/second (higher if Target Eb/No margin > 1 dB)
Max ModCod update rate	1 update every 1.7 seconds
Configurable parameters	<ul style="list-style-type: none"> • Maximum ModCod (ModCod00 through ModCod37, Long Block) • Maximum ModCod (ModCod00 through ModCod35, Short Block) • Remote Demod Unlock Action: Go to minimum ModCod • Target SNR margin (0 to 4.5 dB, 0.5 dB steps)
System latency @ 100 ksps	Long Block - 205 milliseconds max (not including WAN buffer, or satellite path) Short Block – 40.4 milliseconds max (not including WAN buffer, or satellite path)
Monitored parameters	<ul style="list-style-type: none"> • Tx and Rx ModCods • Local and Remote SNR (-3.0 dB to +22.0dB, 0.1dB resolution, +/- 0.5 dB accuracy) • Config and monitor menus displaying data rate, modulation and code rate update dynamically with ModCod
List of ModCods	See Tables 1-3 and 1-4

Table 1-3. The VersaFEC-2 ModCod Set – Long Block

ModCod	Modulation	Code Rate	Spectral efficiency, bps/Hz	Block size, bits	Typical * Es/No (SNR), for BER = 1×10^{-8} (dB)	Latency at 128 kbps (ms)	Min. Data Rate, CCM Mode (kbps)	Max. Data Rate, CCM Mode (Mbps)	Min Sym Rate, ACM Mode (ksps)	Max Sym Rate, ACM Mode (Mpsps)
00	BPSK	0.489	0.489	4800	-1.3	79	18.0	6.1	37	12.5
01	QPSK	0.489	0.977	9600	1.5	153	18.0	12.2	37	12.5
02	QPSK	0.537	1.075	10560	2.0	170	19.3	13.4	37	12.5
03	QPSK	0.586	1.173	11520	2.6	185	21.1	14.7	37	12.5
04	QPSK	0.611	1.221	12000	2.8	193	22.0	15.3	37	12.5
05	QPSK	0.635	1.270	12480	3.2	200	22.9	15.9	37	12.5
06	QPSK	0.660	1.319	12960	3.5	208	23.7	16.5	37	12.5
07	QPSK	0.684	1.368	13440	3.7	215	24.6	17.1	37	12.5
08	QPSK	0.733	1.466	14400	4.4	231	26.4	18.3	37	12.5
09	8-ARY	0.521	1.564	15360	5.1	246	28.1	19.5	37	12.5
10	8-ARY	0.537	1.612	15840	5.4	254	29.0	20.2	37	12.5
11	8-ARY	0.562	1.686	16560	5.6	265	30.3	21.1	37	12.5
12	8-ARY	0.586	1.759	17280	5.8	276	31.7	22.0	37	12.5
13	8-ARY	0.611	1.832	18000	6.0	287	33.0	22.9	37	12.5
14	8-ARY	0.635	1.906	18720	6.2	299	34.3	23.8	37	12.5
15	8-ARY	0.660	1.979	19440	6.5	311	35.6	24.7	37	12.5
16	8-ARY	0.684	2.052	20160	6.9	322	36.9	25.0	37	12.2
17	8-ARY	0.708	2.125	20880	7.2	333	38.3	25.0	37	11.8
18	8-ARY	0.733	2.199	21600	7.5	345	39.6	25.0	37	11.4
19	16-ARY	0.586	2.345	23040	8.1	368	42.2	25.0	37	10.7
20	16-ARY	0.611	2.443	24000	8.6	383	44.0	25.0	37	10.2
21	16-ARY	0.635	2.541	24960	8.9	398	45.7	25.0	37	9.8
22	16-ARY	0.660	2.638	25920	9.2	413	47.5	25.0	37	9.5
23	16-ARY	0.684	2.736	26880	9.6	429	49.3	25.0	37	9.1
24	16-ARY	0.708	2.834	27840	10.0	444	51.0	25.0	37	8.8
25	16-ARY	0.733	2.932	28800	10.5	459	52.8	25.0	37	8.5
26	16-ARY	0.757	3.029	29760	10.9	474	54.5	25.0	37	8.3
27	16-ARY	0.782	3.127	30720	11.4	489	56.3	25.0	37	8.0
28	32-ARY	0.660	3.298	32400	12.0	517	59.4	25.0	37	7.6
29	32-ARY	0.684	3.420	33600	12.5	535	61.6	25.0	37	7.3
30	32-ARY	0.708	3.542	34800	12.9	554	63.8	25.0	37	7.1
31	32-ARY	0.733	3.664	36000	13.3	573	66.0	25.0	37	6.8
32	32-ARY	0.757	3.787	37200	13.7	592	68.2	25.0	37	6.6
33	32-ARY	0.782	3.909	38400	14.2	610	70.4	25.0	37	6.4
34	32-ARY	0.801	4.007	39360	14.7	625	72.1	25.0	37	6.2
35	32-ARY	0.831	4.153	40800	15.2	648	74.8	25.0	37	6.0
36	32-ARY	0.855	4.275	42000	16.0	667	77.0	25.0	37	5.8
37	32-ARY	0.879	4.397	43200	16.7	685	79.2	25.0	37	5.7

Table 1-4. The VersaFEC-2 ModCod Set – Short Block

ModCod	Modulation	Code Rate	Spectral efficiency, bps/Hz	Block size, bits	Typical * Es/No (SNR), for BER = 1×10^{-8} (dB)	Latency at 128 kbps (ms)	Min. Data Rate, CCM Mode (kbps)	Max. Data Rate, CCM Mode (Mbps)	Min Sym Rate, ACM Mode (ksps)	Max Sym Rate, ACM Mode (Mpsps)
00	BPSK	0.489	0.489	800	-0.2	16	18.0	2.0	37	1
01	QPSK	0.489	0.977	1600	2.3	30	18.0	2.0	37	1
02	QPSK	0.537	1.075	1760	2.8	33	19.3	2.0	37	1
03	QPSK	0.586	1.173	1920	3.4	36	21.1	2.0	37	1
04	QPSK	0.611	1.221	2000	3.7	37	22.0	2.0	37	1
05	QPSK	0.635	1.270	2080	3.9	38	22.9	2.0	37	1
06	QPSK	0.660	1.319	2160	4.2	39	23.7	2.0	37	1
07	QPSK	0.684	1.368	2240	4.5	41	24.6	2.0	37	1
08	QPSK	0.733	1.466	2400	5.2	43	26.4	2.0	37	1
09	8-ARY	0.521	1.564	2560	5.6	46	28.1	2.0	37	1
10	8-ARY	0.537	1.612	2640	5.9	47	29.0	2.0	37	1
11	8-ARY	0.562	1.686	2760	6.2	49	30.3	2.0	37	1
12	8-ARY	0.586	1.759	2880	6.4	51	31.7	2.0	37	1
13	8-ARY	0.611	1.832	3000	6.6	53	33.0	2.0	37	1
14	8-ARY	0.635	1.906	3120	6.9	55	34.3	2.0	37	1
15	8-ARY	0.660	1.979	3240	7.2	57	35.6	2.0	37	1
16	8-ARY	0.684	2.052	3360	7.5	59	36.9	2.0	37	1
17	8-ARY	0.708	2.125	3480	7.8	61	38.3	2.0	37	1
18	8-ARY	0.733	2.199	3600	8.3	63	39.6	2.0	37	1
19	16-ARY	0.586	2.345	3840	8.7	67	42.2	2.0	37	1
20	16-ARY	0.611	2.443	4000	9.0	70	44.0	2.0	37	1
21	16-ARY	0.635	2.541	4160	9.3	73	45.7	2.0	37	1
22	16-ARY	0.660	2.638	4320	9.7	76	47.5	2.0	37	1
23	16-ARY	0.684	2.736	4480	10.3	79	49.3	2.0	37	1
24	16-ARY	0.708	2.834	4640	10.7	82	51.0	2.0	37	1
25	16-ARY	0.733	2.932	4800	11.0	85	52.8	2.0	37	1
26	16-ARY	0.757	3.029	4960	11.6	88	54.5	2.0	37	1
27	16-ARY	0.782	3.127	5120	12.2	91	56.3	2.0	37	1
28	32-ARY	0.660	3.298	5400	12.8	93	59.4	2.0	37	1
29	32-ARY	0.684	3.420	5600	13.1	96	61.6	2.0	37	1
30	32-ARY	0.708	3.542	5800	13.4	99	63.8	2.0	37	1
31	32-ARY	0.733	3.664	6000	14.0	102	66.0	2.0	37	1
32	32-ARY	0.757	3.787	6200	14.4	105	68.2	2.0	37	1
33	32-ARY	0.782	3.909	6400	14.8	109	70.4	2.0	37	1
34	32-ARY	0.801	4.007	6560	15.2	112	72.1	2.0	37	1
35	32-ARY	0.831	4.153	6800	15.8	117	74.8	2.0	37	1

1.4.9 Miscellaneous

Front Panel	Tactile keypad, 6 keys (up, down, left, right, ENTER, CLEAR) Vacuum Fluorescent Display (blue) – two lines @ 40 characters/line
Loopbacks	Internal IF loopback, RF loopback, digital loopback, and inward/outward loopback
Fault relays	Hardware fault, Rx and Tx Traffic Alarms, Open Network Backward Alarms Type: Form C Contacts. Rating: Up to ±50 volts, maximum 0.5 Amp
M&C Interface	EIA-232 and EIA-485 (addressable multidrop, 2-wire or 4-wire) or Ethernet (10/100 BaseT)
M&C Software	Serial comms, SNMP, Telnet, HTTP (Web Server)
Firmware update	FTP protocol via Ethernet port
Dimensions	1RU high, 17.65 inches (448 mm) deep
Weight	10.5 lbs (4.8 kg) maximum (All option cards and 48V BUC supply installed)
AC consumption	48 watts (typical, TPC/LDPC Codec module installed), 68 watts (maximum) 280 watts (typical, TPC/LDPC Codec module and 48 volt BUC supply installed, 300 watts (max)
AC operating voltage	100-240 VAC Nominal - autosensing 90-264 VAC Maximum
DC consumption (option)	As above (AC consumption)
DC operating voltage	20-60 VDC Nominal 36-60 VDC Maximum
Operating temperature	32° -122°F (0°-50°C) 'ER' VERSION: 32°-140°F (0°-60°C)

1.4.10 Approvals

"CE" as follows:	EN 55022 Class B (Emissions)	EN 61000-3-2	EN 61000-4-6
	EN 50082-1 (Immunity)	EN 61000-3-3	EN 61000-4-8
FCC	EN 60950-1 (Safety)	EN 61000-4-2	EN 61000-4-9
		EN 61000-4-4	EN 61000-4-11
		EN 61000-4-5	EN 61000-4-13
Federal Communications Commission Federal Code of Regulation FCC Part 15, Subpart B.			

Chapter 2. INSTALLATION

2.1 Unpack and Inspect the Shipment

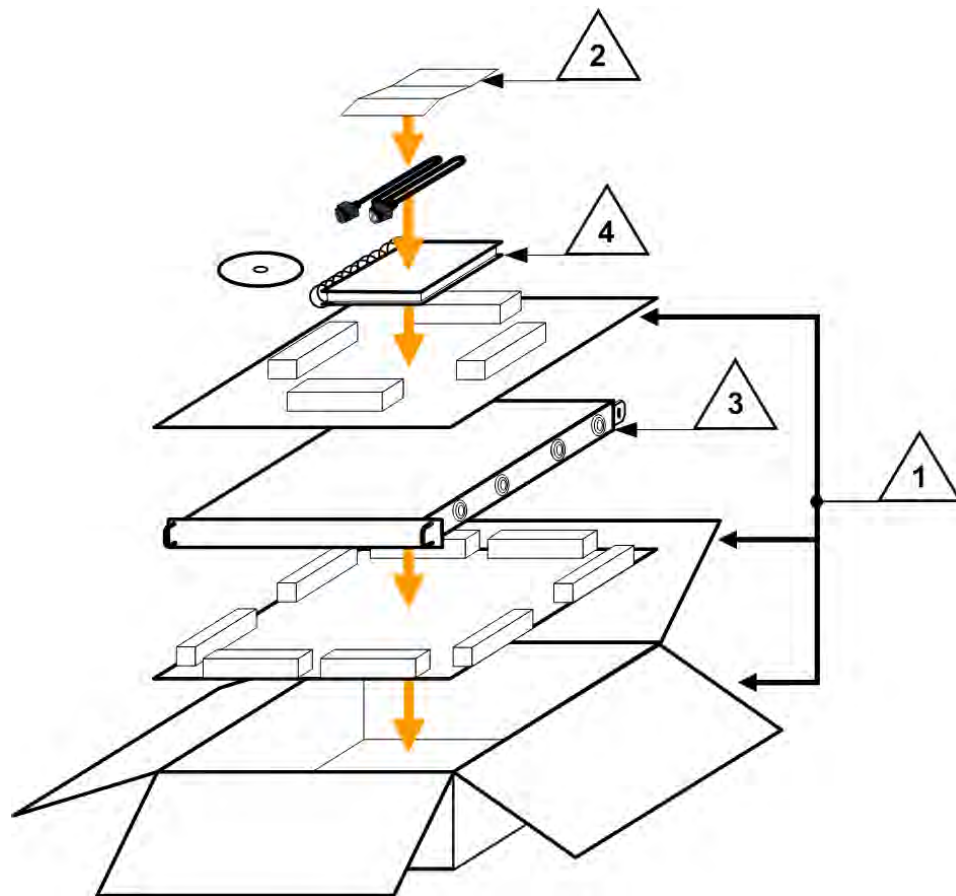

Figure 2-1. Unpack and Inspect the Shipment

The CDM-625A Advanced Satellite Modem, its optional Installation and Operation Manual (otherwise available online at <http://www.comtechefdata.com>), and its power cord were packaged and shipped in a reusable cardboard carton containing protective foam spacing.



CAUTION – THIS EQUIPMENT CONTAINS PARTS AND ASSEMBLIES SENSITIVE TO DAMAGE BY ELECTROSTATIC DISCHARGE (ESD). USE ESD PRECAUTIONARY PROCEDURES WHEN HANDLING THE EQUIPMENT.



Once opened, inspect the shipment:

Step	Task
1	Keep all shipping materials.
2	Check the packing list to make sure the shipment is complete.
3	Inspect the equipment for damage. If damage exists, immediately contact the carrier and Comtech EF Data to submit a damage report.
4	Read the manual.

2.2 Install the Modem Into a Rack Enclosure

Mount the modem into its assigned position in the rack enclosure (**Figure 2-2**). Use, as required:

- A standard rack-mounted shelf;
- User-supplied screws to secure the front panel to the rack enclosure threaded front mounting rails;
- Comtech EF Data's optional KT/6228 (4") or KT/6228 (10") Rear-Mounting Support Brackets Kit (**Figure 2-3**).



CAUTION – When mounting the modem into a rack enclosure:

- **PROPER GROUNDING PROTECTION IS REQUIRED.** The equipment must be connected to the protective earth connection at all times. It is therefore imperative that the modem is properly grounded, using the ground stud provided on the modem rear panel, during installation, configuration, and operation.
 - In Finland: "Laitte on liitettävä suojavaadoituskoskettimilla varustettuun pistorasiaan."
 - In Norway: "Apparatet må tilkoples jordet stikkontakt."
 - In Sweden: "Apparaten skall anslutas till jordat uttag."
- **PROPER AIR VENTILATION IS REQUIRED.** In a rack system where there is high heat discharge, provide forced-air cooling with top- or bottom-mounted fans or blowers.
 - Make sure there is adequate clearance inside the enclosure, especially at the side for air ventilation.
 - Air temperature inside the rack enclosure should **never** exceed 50°C (122°F).

For information about custom rack enclosures, contact Comtech EF Data Product Support.

- The CDM-625A CANNOT have rack slides mounted to the sides of the chassis. Cooling fans and exhaust vents are provided here – air flow must not be impeded. Comtech EF Data recommends that an alternate method of support is provided within the rack, such as standard rack shelves or the optional Rear-Mounting Support Bracket Kit. If there is any doubt, contact Comtech EF Data Product Support.

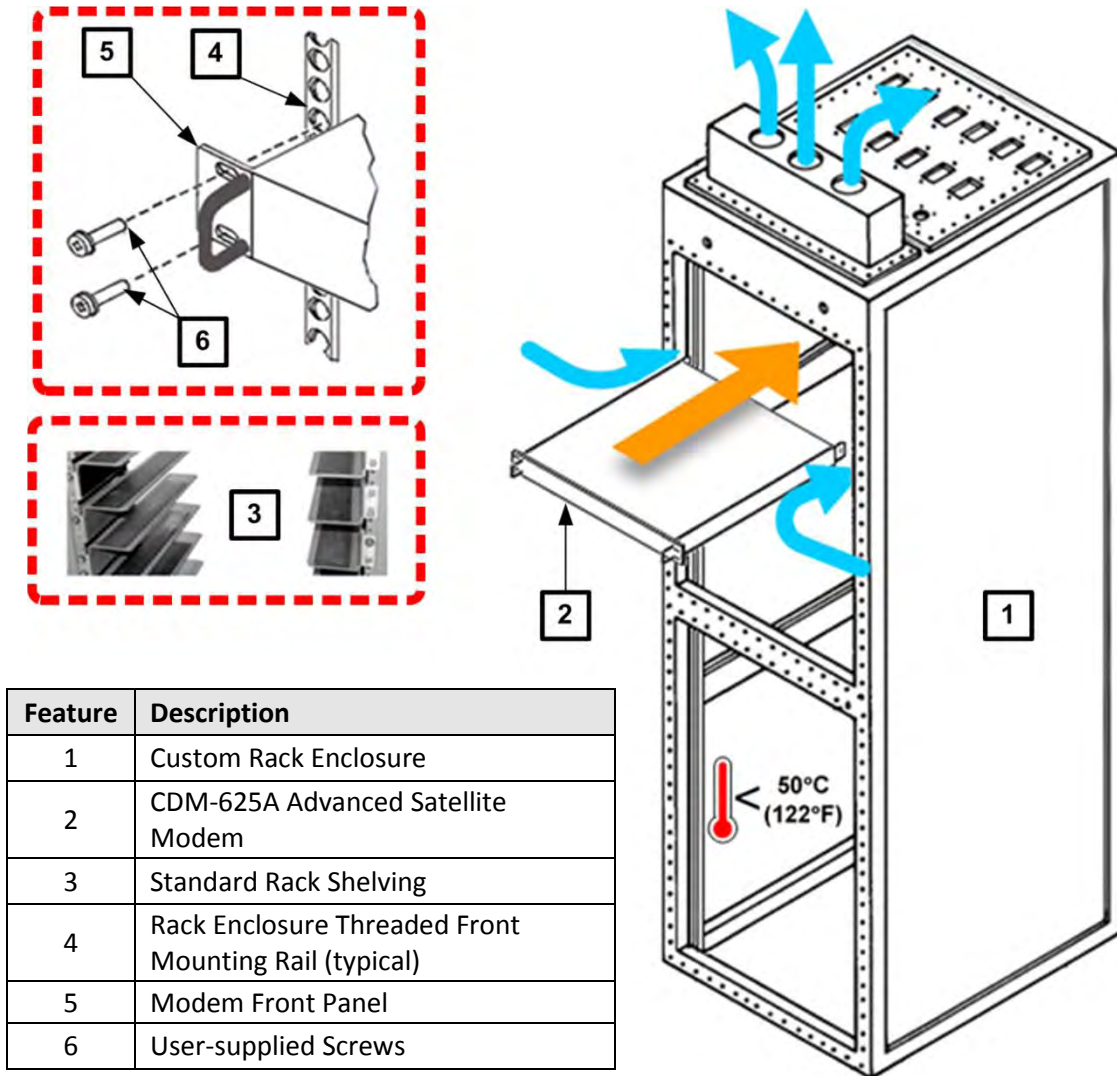
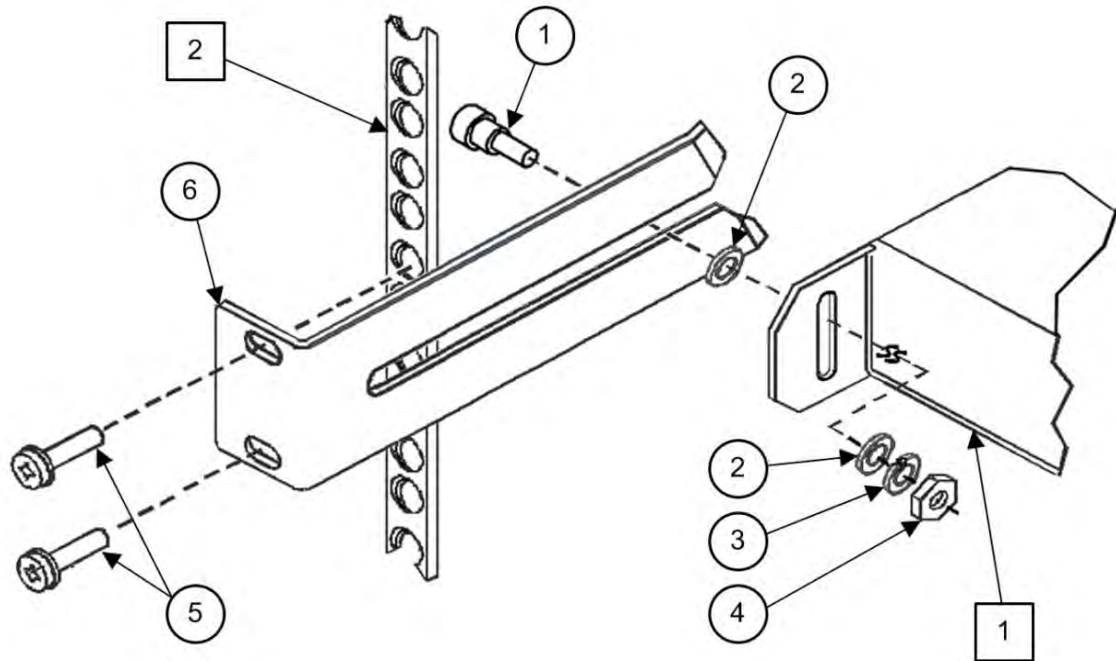

Figure 2-2. Install the modem Into a Rack Enclosure

2.2.1 Install the Optional Rear-Mounting Support Brackets Kits



Feature	Description
1	Back of modem
2	Rack Enclosure Threaded Rear Mounting Rail (typical)

Item	Kit / Quantity		CEFD P/N	Description
	KT/6228-2	KT/6228-3		
1	2	2	HW/10-32SHLDR	Shoulder Screw, #10
2	4	4	HW/10-32FLT	Flat Washer, #10
3	2	2	HW/10-32SPLIT	Lock Washer, #10
4	2	2	HW/10-32HEXNUT	Hex Nut, #10
5	4	4	HW/10-32x1/2RK	Bolt, #10, Rear Support Bracket
6	2	-	FP/6138-2	Bracket, Rear Support - 4"
	-	2	FP/6138-3	Bracket, Rear Support - 10"

Figure 2-3. Install the Optional Rear-Mounting Support Brackets Kit

Tools needed to install the optional KT/6228 (4") or KT/6228 (10") Rear-Mounting Support Brackets Kit:

- A medium Phillips™ screwdriver
- A 5/32-inch SAE Allen™ Wrench
- An adjustable Crescent™ wrench.

To install the optional KT/6228 (4”) or KT/6228 (10”) Rear-Mounting Support Brackets Kit, do these steps:

Step	Task
1	Use the #10 flat washers, #10 split washers, and #10 hex nut to secure the #10 shoulder screws to the modem chassis through the rear right and left side mounting slots as shown.
2	Use the #10 rack bracket bolts to install the rear support brackets onto the rack enclosure threaded rear mounting rails.
3	Mount the modem into the rack enclosure. Ensure that the shoulders of the #10 shoulder screws properly engage into the rear support bracket slots.

2.3 Configure the Modem



Chapter 6. FRONT PANEL OPERATION

The modem is shipped with a default 64 kbps, QPSK, Rate 1/2 configuration. There are no internal jumpers to configure, no interface cards to install, and no other options to install. Configuration is carried out entirely via the modem’s installed firmware – use the front panel keypad and display to configure the modem locally.



The auto-sensing AC power supply does not require any adjustments. Simply plug in the supplied line cord, and turn on the rear panel switch.

2.4 Verify Modem Operation



Chapter 6. FRONT PANEL OPERATION – Sect. 6.2.2 SELECT: Test Menu Branch

You may use the modem’s test functions to quickly verify proper operation of the modem, without the need for externally connected equipment. Use the front panel keypad and, from the top level menu, select **TEST: Mode → IF↓ (IF LOOP)**. The demod should synchronize, and the Rx TRAFFIC LED should illuminate GREEN. If the modem does not pass this test, contact Comtech EF Data Product Support for further assistance.

2.5 Connect the External Cables



Chapter 3. REAR PANEL CONNECTORS AND PINOUTS

Once you verify correct operation via the Internal IF Loop test, use the front panel keypad to finalize your configuration as needed. Connect all external cables. If difficulties occur, contact Comtech EF Data Product Support for further assistance.

Chapter 3. REAR PANEL CONNECTORS AND PINOUTS

3.1 Cabling Connection Types

The CDM-625A Advanced Satellite Modem uses a number of different cables. Each cable type is typically dedicated to a specific mode of operation types – see **Section 3.2**.



- 1) Not all of these operational interface types may be available.
- 2) The European EMC Directive (EN55022, EN50082-1) requires using properly shielded cables for DATA I/O. These cables must be double-shielded from end-to-end, ensuring a continuous ground shield.

3.1.1 Coaxial Cable Connections





Coupling Type	Connector Type	
	Plug	Jack
Bayonet (Type 'BNC' shown)		
Threaded (Type 'N' shown)		

Figure 3-1. Coaxial Connector Examples

The types of coaxial cables used by Comtech EF Data are 'BNC', 'TNC', 'N', 'F', and 'SMA'. Coaxial cables (plugs) and their mating connectors (jacks/sockets) are available in two coupling styles: **Bayonet** or **Threaded**.

- **Bayonet Coupling Style:** The jack has a pair of guideposts that accommodate the plug's lockdown slots. This lockdown design provides secure assembly without over-tightening the connection.

- **Threaded Coupling Style:** The jack features external threads. The plug shell features internal threads, and has either a knurled outer surface to permit hand-tightening of the connection, or hex flats to accommodate torqued installation.

Connection Instructions:

- **Bayonet Coupling Connections:** Use the plug slots to guide, then slide the plug onto the jack posts. Then, turn the plug clockwise until the jack posts are fully seated within the plug slot.
- **Threaded Coupling Connections:** Engage the plug onto the jack threads, and then turn the plug clockwise until it is fully threaded onto the jack. Do not over-tighten the connection.

3.1.1.1 Type 'BNC'

BNC connectors feature a **Bayonet Coupling** design.



3.1.1.2 Type 'TNC'

TNC connectors feature a **Threaded Coupling** design similar to Type 'N', Type 'F,' and Type 'SMA' connectors.



3.1.1.3 Type 'N'

Type 'N' connectors feature a **Threaded Coupling** design similar to Type 'TNC', Type 'F', and Type 'SMA' connectors.



3.1.1.4 Type 'F'

Type 'F' connectors feature a **Threaded Coupling** design similar to Type 'TNC', Type 'N', and Type 'SMA' connectors.



3.1.1.5 Type 'SMA' (Subminiature Version 'A')

Type 'SMA' connectors feature a **Threaded Coupling** design similar to Type 'TNC', Type 'N', and Type 'F' connectors.

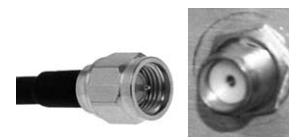

3.1.2 D-Subminiature Cable Connections



Type 'D' Connection Type	Example
<p style="text-align: center;">Chassis Receptacles: Female (TOP) Male (BOTTOM)</p>	
<p style="text-align: center;">Type 'D' Cable with Jack Screws (female shown)</p>	

Figure 3-2. D-Subminiature Connector Examples

D-Subminiature connectors are also called **Type 'D'** or **'D-Sub'** connectors. The connector pair features multiple rows of pins (male side) coupled to mating sockets (female side). The cable plug and chassis receptacle each feature a D-shaped profile that interlock to ensure proper pin orientation and connector seating.

Either chassis receptacle gender features two jack nuts for secure assembly of the cable plug to the chassis receptacle.

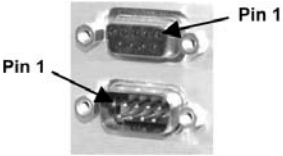
Whether its gender is male or female, the cable plug features two jack screws for secure connection to the jack nuts provided on the mating chassis receptacle. The jack screws may be hand tightened or tightened with a standard flat-blade screwdriver.

Connection Instructions: Orient the plug to the receptacle in the proper position. Press firmly into place. Use the jack screws to secure the plug to the receptacle jack nuts. Do not over-tighten.

About connector pinout tables: Figure 3-2 identifies the Pin 1 location for either gender connector. Unless noted otherwise, the connector pinout tables provided in this manual arrange/order information (i.e., the Pin # column/row) based on this orientation.

3.1.3 RJ-45, RJ-48 Cable Connections

The plug for an RJ-45 or RJ-48 cable features a flexible tab. The RJ-45 or RJ-48 jack features a mating slot. This design configuration assures proper installation and pin orientation.

Connection Instructions: Press down the tab on the cable plug, and then insert the plug into the RJ-4x jack. The connection is complete when the tab 'clicks' into position inside the jack.



3.2 CDM-625A Cabling Connections

The rear panel connectors provide all necessary external connections between the unit and other equipment.

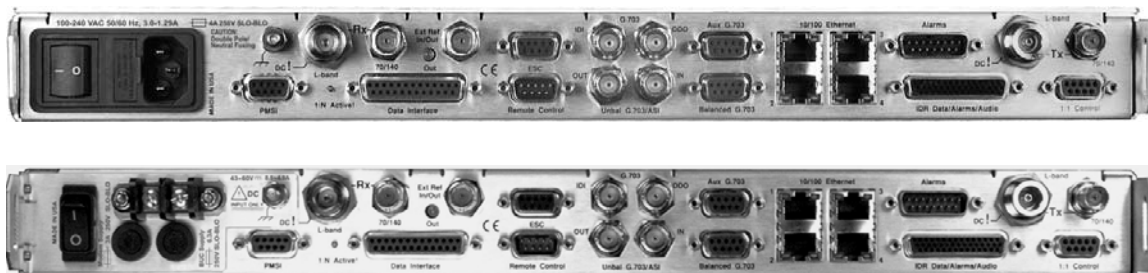

(TOP) Standard AC Chassis (CEFD P/N PL-0021325)
(BOTTOM) Optional 48V DC Chassis (CEFD P/N PL-0021327)

Connector Group (Sect)	Name	Connector Type	Function	
IF Sect. 3.2.1	Rx	BNC female (70/140MHz band)	IF Input	
		Type 'N' female (L-Band)		
	Tx	BNC female (70/140MHz band)	IF Output	
		Type 'N' female (L-Band)		
Terrestrial Data Sect. 3.2.2	Data Interface	25-pin Type 'D' female	Serial synchronous data input/output	
	G.703 Data	Balanced G.703	9-pin Type 'D' female	G.703, D&I or D&I++; Quad E1 Ports 1 & 2
		Auxiliary G.703	9-pin Type 'D' female	Quad E1 Ports 3 & 4
		Unbalanced Out	BNC female	Receive G.703 (IDO); ASI
		Unbalanced In	BNC female	Transmit G.703 (DDI);ASI
		IDI	BNC female	Insert Data In / Sub-rate Auxiliary Tx G.703 In
	DDO	BNC female	Drop Data Output / Sub-rate Auxiliary Rx G.703 Out	
	10/100 Ethernet	(4X) RJ-45 female	10/100 Base-T management and data	
	IDR Data/Alarms/Audio	44-pin High Density Type 'D' female	Intelsat Open Network auxiliary signals	
ESC	9-pin Type 'D' female	ESC Input/output (EIA-232/485)		
Utility Sect. 3.2.3	Remote Control	9-pin Type 'D' male	Serial Remote Interface (EIA-232/485)	
	Alarms	15-pin Type 'D' male	Form C Alarms (relay closures)	
	PMSI	9-pin Type 'D' female	Pre-Mapped Symbol Interface (CnC)	
	1:1 Control	9-pin Type 'D' female	Connection to External 1:1 Controller	
	External Reference	BNC female	Input/output	

Figure 3-3. CDM-625A Rear Panel View

3.2.1 IF Connection Group



WARNING! THERE MAY BE DC VOLTAGES, UP TO A MAXIMUM OF 48 VOLTS, PRESENT ON THE TYPE 'N' RX AND TX IF CONNECTORS.

3.2.1.1 Rx IF Connectors

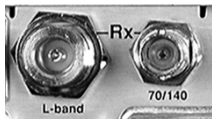

Connector Type	Description	Direction
Type 'N'	Rx IF signal, L- band	In
BNC	Rx IF signal, 70/140 MHz band	

3.2.1.2 Tx IF Connectors

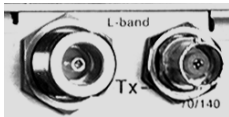

Connector Type	Description	Direction
Type 'N'	Tx IF signal, L- band	Out
BNC	Tx IF signal, 70/140 MHz band	

3.2.2 Terrestrial Data Connection Group

3.2.2.1 Data Interface (DB-25F)

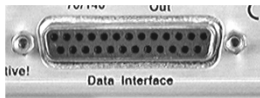

The Data Interface connector is a 25-pin, Type ‘D’ female interface that conducts data input and output signals to and from the modem, and connects to customer’s terrestrial equipment, breakout panel, or protection switch.

Table 3-1. Data Interface Connector Pinouts

(R>L) Pin #	Generic Signal Description	Direction	EIA-422 EIA 530	V.35	HSSI	LVDS	Circuit #
13	Clear to Send B *	Modem to DTE	CS B	–	–	–	106
25	(NOTE 2)						
12	Internal Transmit Clock B	Modem to DTE	ST B	SCT B	ST B	ST B	114
24	Transmit Clock A	DTE to Modem	TT A	SCTE A	TT A	TT A	113
11	Transmit Clock B	DTE to Modem	TT B	SCTE B	TT B	TT B	113
23	(NOTE 2)						
10	Receiver Ready B	Modem to DTE	RR B	–	CA B	RR B	109
22	Data Set Ready B (NOTE 2)	Modem to DTE	DM B	–	–	–	–
9	Receive Clock B	Modem to DTE	RT B	SCR B	RT B	RT B	115
21	(NOTE 2)						
8	Receiver Ready A	Modem to DTE	RR A	RLSD	CA A	RR A	109
20	(NOTE 2)						
7	Signal Ground	–	SG	SG	SG	SG	102
19	Request to Send B *	DTE to Modem	RS B	–	TA B	–	105
6	Data Set Ready A (NOTE 2)	Modem to DTE	DM A	DSR	–	–	–
18	(NOTE 2)						
5	Clear to Send A *	Modem to DTE	CS A	CTS	–	–	106
17	Receive Clock A	Modem to DTE	RT A	SCR A	RT A	RT A	115
4	Request to Send A *	DTE to Modem	RS A	RTS	TA A	–	105
16	Receive Data B	Modem to DTE	RD B	RD B	RD B	RD B	104
3	Receive Data A	Modem to DTE	RD A	RD A	RD A	RD A	104
15	Internal Transmit Clock A	Modem to DTE	ST A	SCT A	ST A	ST A	114
2	Transmit Data A	DTE to Modem	SD A	SD A	SD A	SD A	103
14	Transmit Data B	DTE to Modem	SD B	SD B	SD B	SD B	103
1	Shield	–	Shield	FG	Shield	Shield	101

Notes:

- 1) When the rear-panel LED marked “1:N Active!” is **OFF**, all of the signals shown above are available and functional. In addition, pins not shown are not connected, and therefore no damage will occur if other signals are connected to the additional pins.

- 2) When the rear-panel LED marked “1:N Active!” is **ON**, the signals shown highlighted are no longer available. Furthermore, pins 6, 18, 20, 21, 22, 23 and 25 are reserved for use by the 1:N system. **DO NOT** connect signals to any of these pins in this mode. Certain pins have DC voltages present that may damage equipment other than a Comtech EF Data redundancy switch.
- 3) For X.21 operation, use the EIA-422 pins, but ignore Receive Clock if the Modem is DTE, and ignore Transmit clocks if the Modem is DCE.
- 4) For IDR operation using G.703, this primary interface becomes the 8 kbps EIA-422 overhead channel.

3.2.2.1.1 HSSI Operation via the CIC-60 Interface Adapter Module

For HSSI operation (Tx, Rx, or both), the optional CIC-60 Interface Adapter Module (**Figure 3-4**) may be purchased from Comtech EF Data to adapt the Data Interface 25-pin Type ‘D’ female connection to a standard 50-pin Type ‘HD’ HSSI (SCSI-II) female connection.

See **Table 3-2** for the pinouts for the HSSI/EIA-613 side of the CIC-60 Adapter Module.



The modem must first be configured for the appropriate HSSI operation, via the CDM-625A Front Panel, before using this adapter:

**SELECT: Configure → Mode →
(Select HSSI for both Tx Mode / Interface and Rx Mode / Interface)**



Chapter 6. FRONT PANEL OPERATION

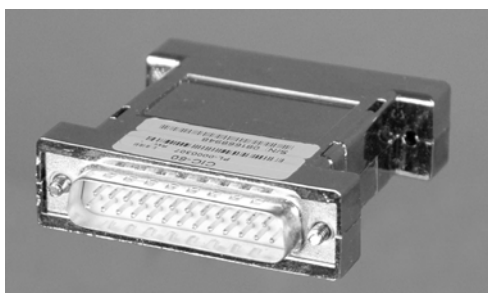

**CIC-60 Interface Adapter Module
(Modem Interface Side)**

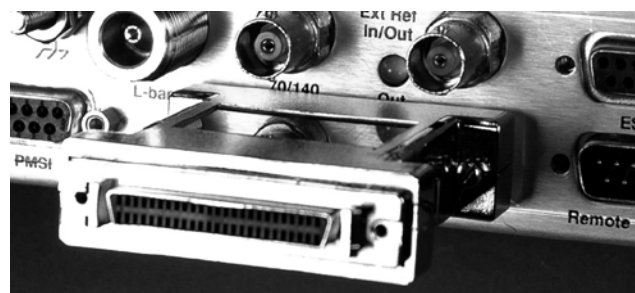

**CIC-60 Interface Adapter Module
(Installed, HSSI Interface Side Shown)**

Figure 3-4. CIC-60 Interface Adapter Module (CEFD P/N PL-0000307)

Table 3-2. CIC-60 Module Connector Pinouts – HSSI/EIA-613 Side

Table ordered by Signal Function					
Signal Function	Pin # (+, -)	HSSI Signal	EIA-613 Circuit	Circuit Direction	Comment
Signal Ground	1, 26	SG	102		Ground
Receive Timing	2, 27	RT	115	From DCE	
DCE Available	3, 28	CA	107	From DCE	
Receive Data	4, 29	RD	104	From DCE	
Loopback circuit C	5, 30	LC	undefined	From DCE	Not used
Send Timing	6, 31	ST	114	From DCE	
Signal Ground	7, 32	SG	102		Ground
DTE Available	8, 33	TA	108/2	to DCE	
Terminal Timing	9, 34	TT	113	to DCE	
Loopback circuit A	10, 35	LA	143	to DCE	Not used
Send Data	11, 36	SD	103	to DCE	
Loopback Circuit B	12, 37	LB	144	to DCE	Not used
Signal Ground	13, 38	SG	102		Ground
Not used	14, 39		undefined		Not used
TX DVALID	15, 40		undefined		Not used
Reserved (to DCE)	16, 41				Not used
Reserved (to DCE)	17, 42				Not used
Reserved (to DCE)	18, 43				Not used
Signal Ground	19, 44	SG	102		Ground
	20		undefined		Not used
	45		undefined		Not used
	21		undefined		Not used
Reserved (to DTE)	46				Not used
	22, 47		undefined	from DCE	Not used
	23, 48		undefined	from DCE	Not used
Test Mode	24, 49	TM	142	from DCE	Not used
Signal Ground	25, 50	SG	102		Ground

3.2.2.2 G.703 Connectors

3.2.2.2.1 Balanced G.703 (DB-9F)



The Balanced G.703 connector is a 9-pin Type 'D' female connector. It is used for single port G.703, D&I or D&I++. When used with Quad E1 operations, this connector serves Ports 1 and 2 of the Quad E1 interface.

Table 3-3. Balanced G.703 Connector Pinouts

(R>L) Pin #	Signal Function Serial G.703	Signal Function D&I or D&I++	Signal Function Quad D&I
5	Tx in (+)	DDI (+)	Port 1 Tx In (+)
9	Tx in (-)	DDI (-)	Port 1 Tx In (-)
4	-	DDO (-)	Port 1 Rx Out (-)
8	-	DDO (+)	Port 1 Rx Out (+)
3	GND	GND	GND
7	-	IDI (+)	Port 2 Tx In (+)
2	-	IDI (-)	Port 2 Tx In (-)
6	Rx Out (+)	IDO (+)	Port 2 Rx Out (+)
1	Rx Out (-)	IDO (-)	Port 2 Rx Out (-)

3.2.2.2.2 Aux G.703 (DB-9F)



The Auxiliary G.703 connector is a 9-pin Type 'D' female connector. When used with Quad E1 operations, this connector serves Ports 3 and 4 of the Quad E1 interface.

Table 3-4. Auxiliary G.703 Connector Pinouts

(R>L) Pin #	Signal Function Serial G.703	Signal Function Quad D&I
5	Tx in (+)	Port 3 Tx in (+)
9	Tx in (-)	Port 3 Tx in (-)
4	-	Port 3 Rx Out (+)
8	-	Port 3 Rx Out (-)
3	GND	GND
7	-	Port 4 Tx in (+)
2	-	Port 4 Tx in (-)
6	Rx Out (+)	Port 4 Rx Out (+)
1	Rx Out (-)	Port 4 Rx Out (-)

3.2.2.2.3 Quad E1 Operation via the Balanced G.703 / Aux G.703 Connectors



Each adapter cable option provides for two of the four ports of the Quad E1 interface. If all four ports of Quad E1 are needed, the user will need to obtain a quantity of (2X) of any adapter option.

For Quad E1 operation, optional Comtech EF Data cabling accessories may be purchased from Comtech EF Data to adapt the Balanced G.703 or Auxiliary G.703 connectors as follows:

Figure	CEFD Part No.	Converts (1) 9-pin Type 'D' Connector (DB-9F) to:
3-5	CA-0000163	(2) DB-15F connections – see Table 3-5 for the connector pinout
3-6	CA-0000164	(2) RJ-48 F connections – see Table 3-6 for the connector pinout
3-7	KT-0000122 or KT-0020570	(2) BNC 75Ω BNC-F connections – see Table 3-7 for the connector pinout

3.2.2.2.3.1 CA-0000163 Adapter Cable

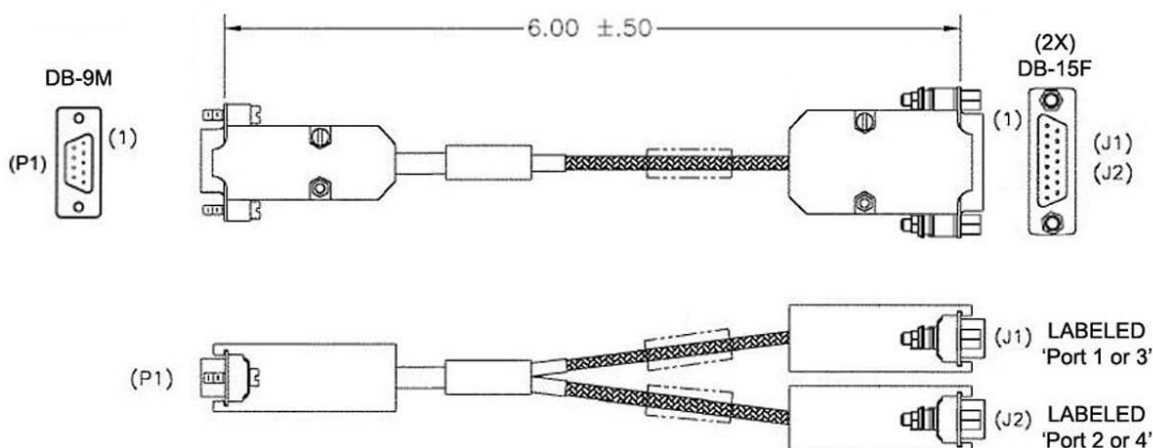

Figure 3-5. CA-0000163 Adapter Cable (DB-9M → (2X) DB-15F)

Table 3-5. CA-0000163 Connector Pinouts

Table ordered by Signal Function				
Signal Function	Connector			Twisted Pair
	P1	J1	J2	
Port 1 or 3 Tx In (+)	5	9	—	X
Port 1 or 3 Tx In (–)	9	1	—	
Port 1 or 3 Rx In (+)	4	11	—	X
Port 1 or 3 Rx In (–)	8	3	—	
Port 2 or 4 Tx In (+)	7	—	9	X
Port 2 or 4 Tx In (–)	2	—	1	
Port 2 or 4 Rx In (+)	6	—	11	X
Port 2 or 4 Rx In (–)	1	—	3	
GND	3	2	2	—

3.2.2.2.3.2 CA-0000164 Adapter Cable

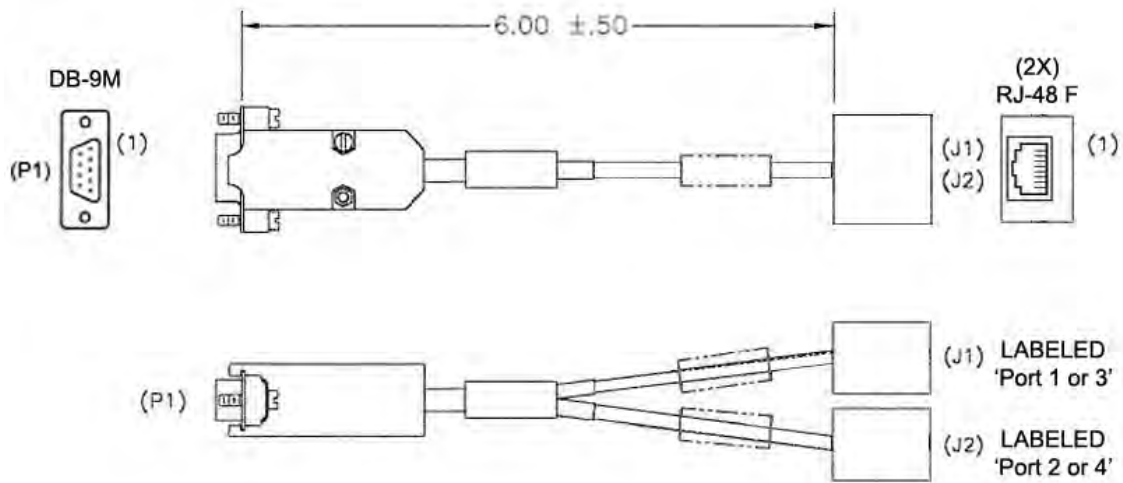
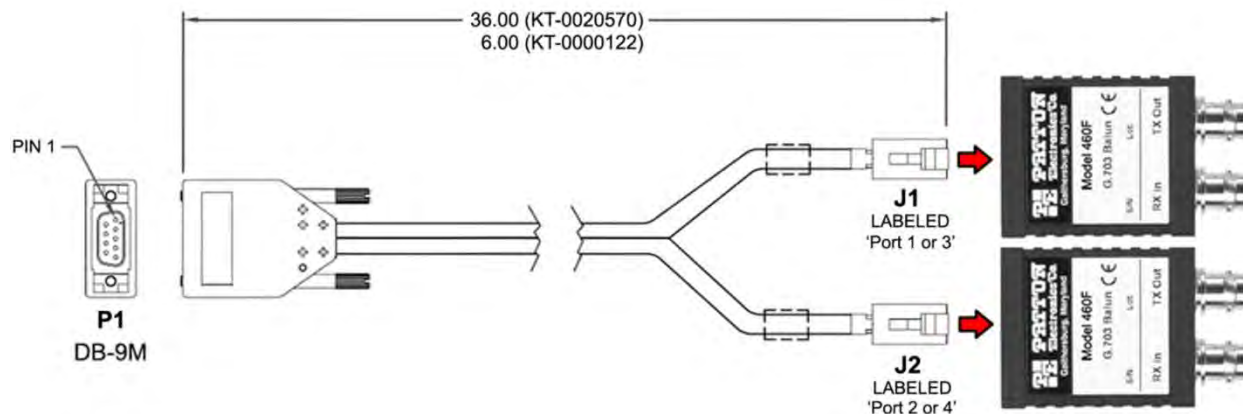

Figure 3-6. CA-0000164 Adapter Cable (DB-9M → (2X) RJ-48F)

Table 3-6. CA-0000164 Connector Pinouts

Table ordered by Signal Function				
Signal Function	Connector			Twisted Pair
	P1	J1	J2	
Port 1 or 3 Tx In (+)	5	1	—	X
Port 1 or 3 Tx In (-)	9	2	—	
Port 1 or 3 Rx In (+)	4	4	—	X
Port 1 or 3 Rx In (-)	8	5	—	
Port 2 or 4 Tx In (+)	7	—	1	X
Port 2 or 4 Tx In (-)	2	—	2	
Port 2 or 4 Rx In (+)	6	—	4	X
Port 2 or 4 Rx In (-)	1	—	5	
GND	3	3	3	—

3.2.2.2.3.3 KT-0000122/KT-0020570 Quad E1 Balanced/Unbalanced Adapter Cable Kits



Quad E1 Balanced/Unbalanced Adapter Kits			
Kit / Quantity		CEFD Part No.	Description
KT-0000122	KT-0020570		
1	—	CA-0000347	Y-Cable Assembly, 6", DB-9M → 2X RJ-48 Male (See Table 3-7)
—	1	CA-0020710	Y-Cable Assembly, 3", DB-9M → 2X RJ-48 Male (See Table 3-7)
2	2	502-0532-001	Bolun Adapter, 2X RJ-48 Female → 2X BNC 75Ω Female

Figure 3-7. Quad E1 Balanced/Unbalanced Adapter Cable Kits

Table 3-7. CA-0000347/CA-0020710 Connector Pinouts

P1 PINOUT (Table ordered by Signal Function)					J1/J2 TYPICAL WIRE CHART	
Signal Function	Connector			Twisted Pair	PIN	WIRE COLOR
	P1	J1	J2			
Port 1 or 3 Tx In (+)	5	1	—	X	1	WHITE / ORANGE STRIPE
Port 1 or 3 Tx In (-)	9	2	—		2	ORANGE
Port 1 or 3 Rx In (+)	4	4	—	X	3	WHITE / GREEN STRIPE
Port 1 or 3 Rx In (-)	8	5	—		4	BLUE
Port 2 or 4 Tx In (+)	7	—	1	X	5	WHITE / BLUE STRIPE
Port 2 or 4 Tx In (-)	2	—	2		6	GREEN
Port 2 or 4 Rx In (+)	6	—	4	X	7	WHITE / BROWN STRIPE
Port 2 or 4 Rx In (-)	1	—	5		8	BROWN
GND	3	3	3	—		

3.2.2.2.4 Unbal G.703 / ASI – Out (IDO), In (DDI)



Connector Type	Description	Direction
BNC	G.703 Unbalanced Rx (IDO) / ASI	Out
	G.703 Unbalanced Tx (DDI) / ASI	In

3.2.2.2.5 G.703 IDI (Insert Data In), DDO (Drop Data Out)



Connector Type	Description	Direction
BNC	IDI (Insert Data Input)	In
	DDO (Drop Data Output)	Out

3.2.2.3 Quad 10/100 Ethernet (RJ-45)

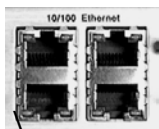

These are four standard RJ-45 female connectors, operating at 10/100 Mbps, half and full duplex, auto-negotiating.

3.2.2.4 IDR Data / Alarms / Audio (HD-44F)



The IDR Data/Alarms/Audio interface is a 44-pin, high-density Type 'D' female connector.

Table 3-8. IDR Data/Alarms/Audio Connector Pinouts

(R>L) Bottom Row Pin #	Description	(R>L) Center Row Pin #	Description	(R>L) Top Row Pin #	Description
		30	EIA-422 Rx ESC Data B Out	15	Ground
44	EIA-422 Rx ESC Data A Out	29	EIA-422 Rx ESC Clock A Out	14	EIA-422 Rx ESC Clock B Out
43	EIA-422 Rx Octet B Out	28	TBD EIA-422 B Out	13	EIA-422 Rx Octet A Out
42	TBD EIA-422 A Out	27	EIA-422 Tx ESC Clock B Out	12	EIA-422 Tx ESC Clock A Out
41	Audio In 1 (+)	26	Audio Out 1 (+)	11	Audio In 1 (-)
40	Audio Out 1 (-)	25	Audio In 2 (-)	10	Audio In 2 (+)
39	Audio Out 2 (+)	24	BWA1 In	9	Audio Out 2 (-)
38	BWA2 In	23	BWA4 In	8	BWA3 In
37		22	EIA-422 Tx Octet A Out	7	EIA-422 Tx Octet B Out
36	EIA-422 Tx ESC Data B In	21	TBD EIA-422 B In	6	EIA-422 Tx ESC Data A In
35	TBD EIA-422 A In	20	BWA1 Out Common	5	No Connect
34	BWA1 Out Normally Open	19	BWA2 Out Common	4	BWA1 Out Normally Closed
33	BWA2 Out Normally Open	18	BWA3 Out Common	3	BWA2 Out Normally Closed
32	BWA3 Out Normally Open	17	BWA4 Out Common	2	BWA3 Out Normally Closed
31	BWA4 Out Normally Open	16	No Connect	1	BWA4 Out Normally Closed

3.2.2.5 ESC (DB-9F)



The ESC (Engineering Service Channel) port is a 9-pin Type 'D' female connector.

Table 3-9. ESC Connector Pinouts

(R>L) Pin #	Asynchronous	Synchronous
5	—	EIA-232 Tx Clock Out
9	EIA-485 Rx Data A Out	—
4	—	EIA-232 Rx Clock Out
8	EIA-485 Rx Data B Out	—
3	EIA-232 Tx Data In	EIA-232 Tx Data In
7	EIA-485 Tx Data A In	—
2	EIA-232 Rx Data Out	EIA-232 Rx Data Out
6	EIA-485 Tx Data B In	—
1	Ground	Ground

3.2.3 Utility Connections Group

3.2.3.1 Remote Control (DB-9M)



The Remote Control interface is a 9-pin Type 'D' male connector. It is intended for connection to an M&C computer or terminal device, and is user selectable for either EIA-232 or EIA-485.

Table 3-10. Remote Control Connector Pinouts

(L>R) Pin #	Description	Direction
1	Ground	—
6	EIA-485 Receive Data 'B' *	In
2	EIA-232 Transmit Data	Out
7	EIA-485 Receive Data 'A' *	In
3	EIA-232 Receive Data	In
8	EIA-485 Transmit Data 'B' *	Out
4	Reserved – Do Not Use	—
9	EIA-485 Transmit Data 'A' *	Out
5	Ground	—

*Use for EIA-485 2-wire operation

3.2.3.2 Alarms (DB-15M)

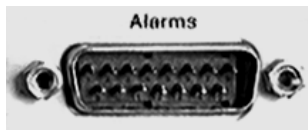

Unit alarms are provided on this 15-pin Type 'D' male connector.

Table 3-11. Alarm Interface Connector Pinouts

(L>R) Pin #	Name	Signal Function
1	GND	Ground
9	EXT-OFF	EXT Carrier OFF
2	AGC	AGC Voltage (Rx signal level, 0 to 10 Volts)
10	N/A	Spare (No connection)
3	RX-Q	Rx Q Channel (Constellation Monitor)
11	RX-I	RX I Channel (Constellation Monitor)
4	UNIT-COM	Unit Fault
12	UNIT-NO	Unit Fault (Energized, No Fault)
5	UNIT-NC	Unit Fault (De-energized, No Fault)
13	TX-COM	Tx Traffic
6	TX-NO	Tx Traffic (Energized, No Fault)
14	TX-NC	Tx Traffic (De-energized, No Fault)
7	RX-COM	Rx Traffic
15	RX-NO	Rx Traffic (Energized, No Fault)
8	RX-NC	Rx Traffic (De-energized, No Fault)

3.2.3.3 PMSI Connector (DB-9F)



The PMSI (**Pre-Mapped Symbol interface**) is a 9-pin Type 'D' female connector. The PMSI is an EIA-485 multidrop bus system, used in tandem with Carrier-in-Carrier (CnC), where one device transmits, and all other devices on the multidrop bus are configured to receive.

Table 3-12. PMSI (Pre-Mapped Symbol Interface) Connector Pinouts

(R>L) Pin #	Description	Direction
5	PMSI MSB – EIA-485 (+)	In/Out
9	PMSI MSB – EIA-485 (-)	In/Out
4	PMSI LSB – EIA-485 (+)	In/Out
8	PMSI LSB – EIA-485 (-)	In/Out
3	PMSI symbol clock – EIA-485 (+)	In/Out
7	PMSI symbol clock – EIA-485 (-)	In/Out
2	Spare (No connection)	—
6	Spare (No connection)	—
1	Ground	—

3.2.3.4 1:1 Control (DB-9F)



The 1:1 Control connector is intended only for connection to a CRS-170A or CRS-180 Redundancy Switch.



The 1:1 Control connector is a 9-pin Type 'D' female connector.

Table 3-13. 1:1 Control Interface Connector Pinouts

(R>L) Pin #	Description	Direction
5	Ground	—
9	Fused +12 volt Out	Out
4	Redundancy In 2	In
8	Redundancy Out 2	Out
3	Redundancy In 1	In
7	Redundancy Out 1	Out
2	Receive Serial Data – Auxiliary Channel	In
6	Transmit Serial Data – Auxiliary Channel	Out
1	Ground	—

3.2.3.5 Ext Ref In/Out

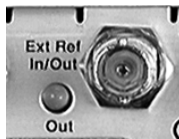

Connector Type	Description	Direction
BNC	External Reference	In/Out

3.3 CDM-625A Ground and Power Connections

3.3.1 Chassis Ground Interface



CAUTION – PROPER GROUNDING PROTECTION IS REQUIRED. The equipment must be connected to the protective earth connection at all times. It is therefore imperative that the unit is properly grounded, using the ground stud provided on the unit rear panel, during installation, configuration, and operation.



(TOP) Standard AC Chassis (CEFD P/N PL-0021325)
(BOTTOM) Optional 48V DC Chassis (CEFD P/N PL-0021327)

Figure 3-8. CDM-625A Chassis Ground Interface

Use the #10-32 stud, located adjacent to the power interface, for connecting a common chassis ground among equipment.



The AC power interface provides the safety ground.

3.3.2 Standard 100V/240V Alternating Current (AC) Power Interface



Feature	Description
1	On / Off Switch
2	Press-fit Fuse Holder
3	IEC-60320 Type C14 Three-prong Connector

AC Power Specifications	
Input Power	48 watts (typical with TPC/LDPC Codec module installed), 68 watts (max)
	280 watts (typical with TPC/LDPC Codec module and 48 volt BUC supply installed), 300 watts (max)
Input Voltage	100V to 240V AC, +6%/-10%, autosensing (total absolute max. range is 90V to 264V AC)
Connection Type	IEC-60320 Type C13/C14
Fuse Protection	Line and neutral fusing (2X) 5mm x 20mm Slow-blow type fuses: T4A (250V AC operation)

Figure 3-9. CDM-625A Standard AC Chassis (CEFD P/N PL/12587-1)

3.3.2.1 AC Operation – CDM-625A Accessories

Contact Comtech EF Data Product Support to purchase any of these available accessories:

CEFD P/N	Description
KT-0020703	AC to 24V DC Conversion Kit
KT-0020775	AC to 48V DC Conversion Kit
KT-0000282	AC Primary Power Supply: 100-240 VAC (65W Power Supply) w/required cables
KT-0020701	AC Primary Power Supply: 100-240 VAC (120W Power Supply) w/required cables
PS-0000075	AC 65W Power Supply
PS-0020524	AC 120W Power Supply
CA/17725	AC Power Cord, Standard (IEC-60320 Type C13) – USA
CA/90025-5FT	AC Power Jumper Cord, Standard (IEC-60320 Type C13)
KT/11633-1	AC Power Cord Retainer Kit (for any AC Cord)
CA/17850	AC Power Cord – European / French
PP-0000097	AC Power Cord – Japanese
PP-0020556	AC Power Cord – India

3.3.2.2 AC Operation – Apply Power



Figure 3-10. Apply AC Power to the CDM-625A

To apply AC power to the CDM-625A (Figure 3-10), do these steps:

- First, plug the provided AC power cord female end into the unit.
- Then, plug the AC power cord male end into the user-supplied power source.
- Finally, switch the unit ON.

3.3.2.3 AC Operation – Replace the Fuses

For AC operation the CDM-625A uses two *common* 5mm x 20mm Slow-blow fuses – one each for line and neutral connections. The fuses are contained within a fuse holder that is press-fit into the body of the IEC power module (located on the rear panel, **Figure 3-11**).

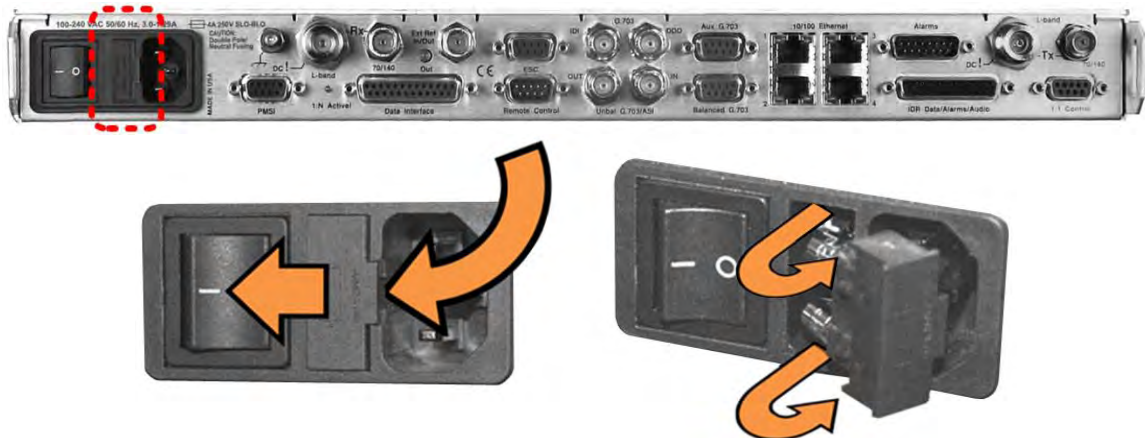

Figure 3-11. Replace the CDM-625A AC Fuses



WARNING! DISCONNECT THE POWER SUPPLY BEFORE PROCEEDING!

To replace the fuse(s), do these steps:

- First, unseat the fuse holder from the IEC power module.

- Use the slot to pry the holder outward from the IEC power module.
- Pull the holder straight out, and then swing the holder away from the module.
- Then, remove and replace the T4A (4 Amp) fuses as needed.



CAUTION – FOR CONTINUED OPERATOR SAFETY, ALWAYS REPLACE THE FUSES WITH THE CORRECT TYPE AND RATING.

- Finally, reseal the fuse holder in the IEC power module.

3.3.3 Optional 48V Direct Current (DC) Power Interface

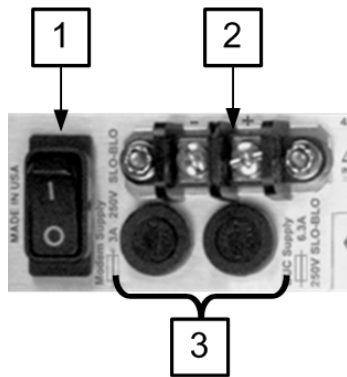

Feature	Description
1	On / Off Switch
2	Power Terminal Block
3	Screw-in Fuse Holders / Receptacles

DC Power Specifications	
Input Power	48 watts (typical with TPC/LDPC Codec installed), 68 watts (max)
	280 watts (typical TPC/LDPC Codec and 48 volt BUC supply installed), 300 watts (max)
Input Voltage	43 – 60 VDC Nominal 36 – 60 VDC Maximum
Connector Type	Terminal Block
Fuse Protection	(2X) 5mm x 20mm Slow-blow type fuses: Modem Fuse: 3Amp/250Volts BUC Fuse: 6.3 Amp/250 Volts

Figure 3-12. CDM-625A Optional DC Chassis (CEFD P/N PL-0021327)

3.3.3.1 Optional DC Operation – CDM-625A Accessories

Contact Comtech EF Data Product Support to purchase any of these available accessories:

CEFD P/N	Description
KT-0020683	DC to AC Conversion Kit for CDM-625A Base Modem
KT-0020777	DC to AC Conversion Kit for CDM-625A with IP Packet Processor
KT-0020692	DC Primary Power Supply: -48 VDC, w/required cables
PS-0020519	DC 48V 120W Power Supply
PS-0020504	DC 24V 120W Power Supply
CA-0000455	DC Pigtail Adapter

3.3.3.2 Optional DC Operation – Apply Power

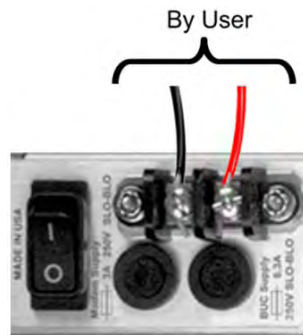

Figure 3-13. Apply Power to the CDM-625A Optional DC Chassis

To apply DC power to the CDM-625A, do these steps:

- First, connect the user-supplied (+) and (-) DC power leads to their respective terminals. *Number 18 AWG minimum wires are recommended.*
- Then, connect the user-supplied DC power leads to the power source.
- Finally, switch the unit ON.

3.3.3.3 Optional DC Operation – Replace the Fuses

For DC operation the CDM-625A requires two *different* fuses that are contained within the individual screw-in receptacles below the terminal block (located on the rear panel, **Figure 3-14**).



Figure 3-14. Replace the CDM-625A Optional DC Chassis Fuses



WARNING! DISCONNECT THE POWER SUPPLY BEFORE PROCEEDING!

To replace the fuses, do these steps:

- First, unscrew either fuse holder from its receptacle. Then, remove and replace the modem and/or the BUC fuse(s):
 - Use T3A (3 Amp) 250V fuses for modem operation (left-hand receptacle).
 - Use T6.3A (6.3 Amp) 250V fuses when a Block Upconverter (BUC) is installed (right-hand receptacle).



CAUTION – FOR CONTINUED OPERATOR SAFETY, ALWAYS REPLACE THE FUSES WITH THE CORRECT TYPE AND RATING.

- Screw either fuse holder back into its receptacle.

Chapter 4. UPDATING FIRMWARE

4.1 Update Firmware via the Internet



BE SURE TO OPERATE THE CDM-625A WITH ITS LATEST AVAILABLE FIRMWARE.

The CDM-625A Advanced Satellite Modem is factory-shipped with its latest version of operating firmware. If a firmware update is needed, once Ethernet connectivity has been established with the unit, you can download the update archive file from the Comtech EF Data Web site (www.comtechefdata.com), or obtain it through e-mail from Comtech EF Data Product Support.

You can perform the CDM-625A Firmware Update without opening the unit as follows:

- Connect the rear panel serial “Remote Control” port or “10/100 Ethernet” port to a serial or Ethernet port of the User PC.
- Download the firmware update archive file via the Internet to the User PC.
- Use File Transfer Protocol (FTP) to transfer the extracted firmware update files from the User PC to the unit.

4.2 About Firmware Files, Naming, Versions, and Archive Formats

Comtech EF Data’s Web site catalogues its firmware update files by product type (e.g., modem, converter, etc.) and specific model/optional configuration. For example, the base modem bulk firmware download hyperlink appears as **F0020731*_V###** (where ‘###’ indicates the firmware version number, and ‘*’ is the revision letter of that version).

In addition to this base modem bulk firmware archive file, downloads are available for the CDM-625A’s optional IP Packet Processor Module, available with or without AES Encryption. This module requires separate firmware update.

Firmware updates are available from Comtech EF Data per the following table:

Label	EXE/ZIP Filename	Contains Image File (where ‘*’ is the revision letter and ‘###’ or ‘#.#.#’ is the version number)
F0020731*_V###	FW-0020731*	FW-0020731*_CDM625A_#.#.#.bin Base modem firmware
F0000342*_V###	FW-0000342*	FW-0000342*-#.#.#.bin IP Packet Processor Module option <u>without</u> AES Encryption.
CONTACT CEFD PRODUCT SUPPORT		FW-0000438*-#.#.#.bin IP Packet Processor Module option <u>with</u> AES Encryption.



Only firmware for the CDM-625A base modem and IP Packet Processor Module without AES Encryption is available for download from the CEFD Web site. Contact Comtech EF Data Product Support to obtain the firmware update for the CDM-625A IP Packet Processor Module with AES Encryption.

The firmware download files are available from Comtech EF Data in two archive file formats: ***.exe** (self extracting) and ***.zip** (compressed). Some firewalls will not allow the downloading of *.exe files; in this case, download the *.zip file instead. If applicable, one version prior to the current release is also available for download.



For additional help with "zipped" file types, refer to the help files provided with the "PKZIP for Windows", "WinZip", or "ZipCentral" file archiving programs. "PKZIP for Command-line" is not supported due to file naming conventions.

To verify the correct firmware number, see Step 1(D) in **Sect. 4.3.1 Getting Started: Prepare for the Firmware Download**.

4.3 Ethernet FTP Upload Procedure

4.3.1 Getting Started: Prepare for the Firmware Download

- 1) First, identify the CDM-625A firmware (number/revision letter/version number) and the assigned Ethernet Traffic/Management IP Address.

User-supplied items needed:

- A Microsoft Windows-based PC, equipped with available serial and Ethernet ports; a compatible Web browser (e.g., Internet Explorer); and a terminal emulator program (e.g., Tera Term or HyperTerminal).
 - A 9-pin serial cable and a standard CAT5 Ethernet cable to connect the CDM-625A to the User PC.
- A. Use the 9-pin serial cable to connect the CDM-625A 'Remote Control' port to a serial port on the User PC. Use an Ethernet hub, switch, or a direct CAT5 Ethernet cable connection to connect a CDM-625A "10/100 Ethernet" port to the User PC.

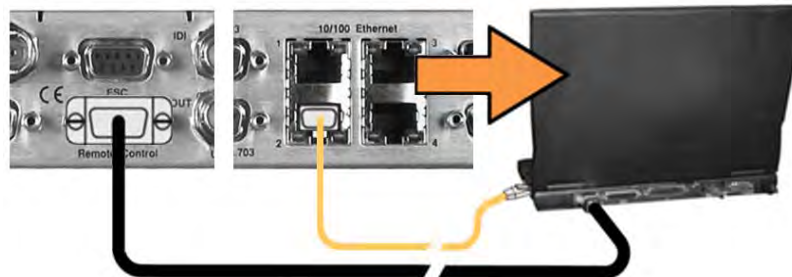

- B. **On the PC:** Open the terminal emulator program.



Refer to your terminal emulator program HELP feature or user guide for operating and configuration instructions.

Configure the utility program serial port communication and terminal display operation:

- 38400 bps (Baud Rate)
- 8 Data Bits
- 1 Stop Bit
- Parity=NO
- Port Flow Control=NONE
- Display New line Rx/Tx: CR
- Local Echo=ON

- C. **On the CDM-625A:** Turn on/connect the power source:

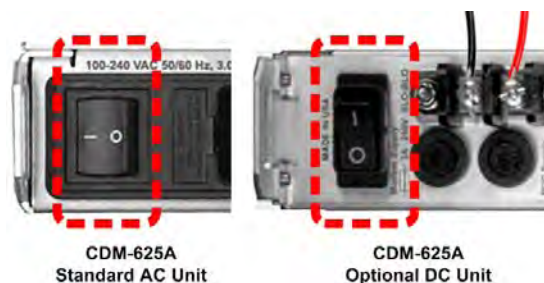

- D. Identify the firmware information and Ethernet Traffic/Management IP Address using one of the following methods:

Using the modem front panel menus:

- **Firmware Info** – Use the **SELECT: UTILITIES → Firmware → Base-modem → Image#1 or Image#2** menu branches, as shown in this example:

```
Image #X Bulk:          DD/MM/YY
FW-0020731X          #.#.# (◀▶)
```

- **Ethernet IP Address** – Use the **CONFIG: IP → Addresses** menu branch, as shown in this example:

```
Ethernet IP Address/Range:
192.168.001.002/24      (◀▶◆)
```

Using the CDM-625A HTTP Interface (via the User PC Web Browser) – this assumes that you have already noted the Traffic/Management IP Address, which was previously required to open the CDM-625A HTTP Interface:

- **Firmware Info** – Use the ‘Admin | Firmware | Base Modem’ and, if needed, the ‘Admin | Firmware | Packet Processor’ pages, as shown here:

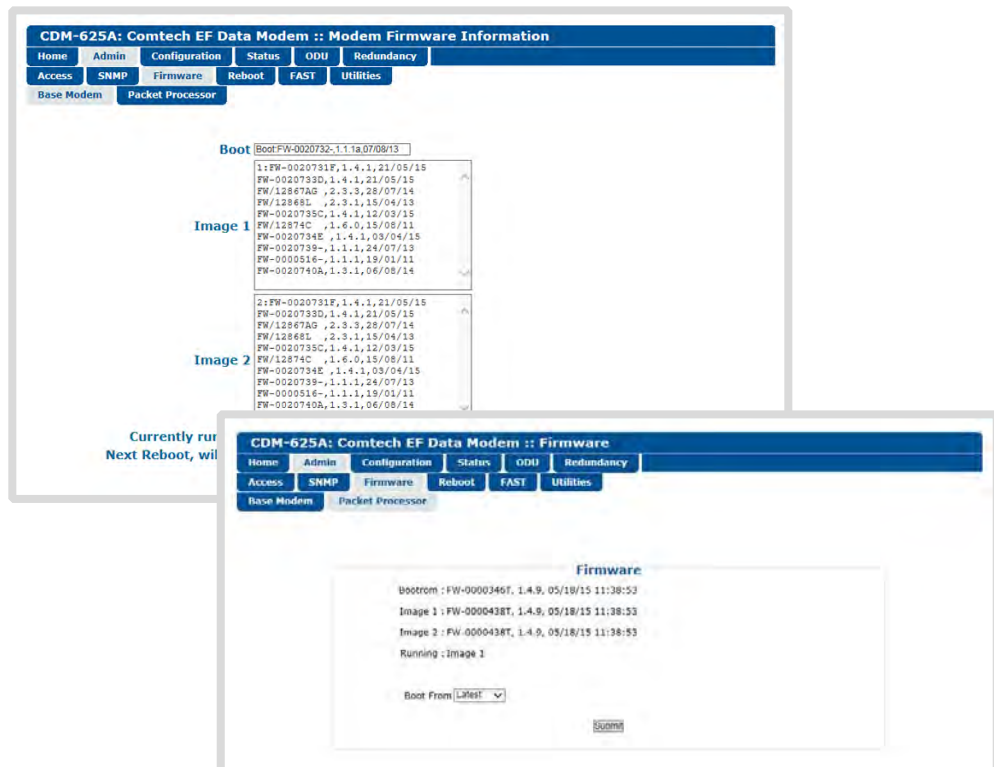

Using the CDM-625A Serial Remote Interface (via the User PC / terminal emulator program):

- **Firmware Info** – Use the **<0/SWR?** (condensed) or **<0/FRW?** (detailed) remote query.
- **Ethernet Traffic/Management IP Address** – Use the **<0/IPA?** remote query.

2) Next, create a temporary folder (subdirectory) on the User PC for the firmware archive download.



- These examples use drive letter "c:". You may use any valid, writable drive letter.
- Typical for all tasks: Type the command without quotes, and then press Enter to execute.

There are several ways to create a temporary folder on a Windows-based PC:

A. Use the Windows Desktop to create and rename the temporary folder.

- Right-click anywhere on the desktop to open the popup submenu, and then select **New > Folder** to create a temporary folder on the desktop.
- Right-click on the new folder and then select "**Rename**" from the popup submenu. Rename this folder to "**temp**" or some other convenient, unused name.



B. Use Windows Explorer to create and rename the temporary folder.

- Select **File > New > Folder** to create a temporary folder. This creates the new folder in the active folder.
- Right-click the "**New Folder**" folder name, and then rename this folder to "**temp**" or some other convenient, unused name:

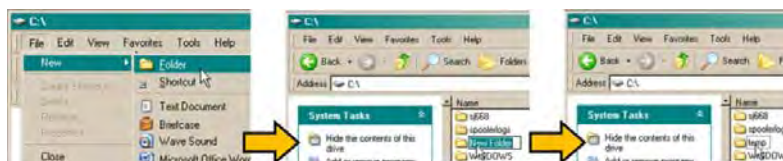

C. Use the 'Run' and 'Browse' windows to create and rename the temporary folder.

- Select **[Start]** on the Windows taskbar, and then click the **Run...** icon. This opens the 'Run' window.
- Click **[Browse]** in the 'Run' window. This opens the 'Browse' window.
- Click the **Create New Folder** icon in the 'Browse' window. This creates the new folder.
- Right-click the "New Folder" folder name, and then rename this folder to "temp" or some other convenient, unused name:

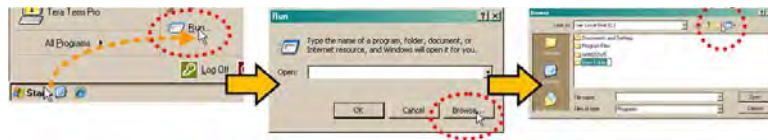

D. Use Windows Command-line to create the temporary folder.

- First, click **[Start]** on the Windows taskbar, and then click the **Run...** icon (or, depending on Windows OS versions prior to Windows 95, click the **MS-DOS Prompt** icon from the **Main Menu**).
- Next, open a **Command-line window...**
 - For Windows 95 or Windows 98, type "command" (or, for any Windows OS versions later than Windows 98, type "cmd" or "command"):



- Alternately, from **[Start]**, select **All Programs > Accessories > Command Prompt**.
- Finally, from the Command-line prompt (c:\>), type "mkdir temp" or "md temp" (**mkdir** and **md** stand for **make directory**), and then click **[OK]**:

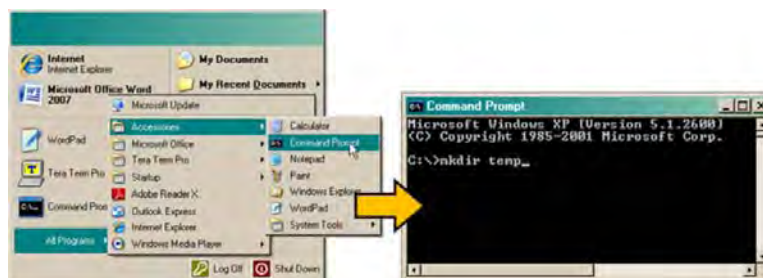

There should now be a "temp" folder created and available for placement of the firmware file download.

4.3.2 Download and Extract the Firmware Update

- 1) First, download the firmware update file from the Comtech EF Data Web site:
 - A. Go online to www.comtechefdata.com.
 - B. On the **Main** page – under Support Information or the Support tab, select the **Software Downloads** hyperlink.
 - C. On the **Software Downloads** page – click **Download Flash and Software Update Files**.
 - D. On the **Flash & Software Update Files** page – select the **(Select a Product Line) Satellite Modems** hyperlink.
 - E. On the Satellite Modems product page – select the **CDM-625A** product hyperlink.
 - F. Select the appropriate firmware archive EXE or ZIP file download hyperlink (i.e., the CDM-625A Base Modem or the CDM-625A with IP Packet Processor without AES Encryption; otherwise, contact Comtech EF Data Product Support to obtain the firmware download for the IP Packet Processor with AES Encryption).



Sect. 4.2 About Firmware Files, Naming, Versions, and Archive Formats

- G. Download the archive file to the temporary folder.
 - Once the EXE or ZIP hyperlink is selected, the ‘**File Download**’ window opens and prompts selection of **[Open]** or **[Save]**:
 - Click **[Open]** to turn over file extraction to the user-supplied utility program. Be sure to extract the firmware files to the “**temp**” folder created earlier.
 - Click **[Save]** to open the ‘**Save As**’ window. Be sure to select and **[Save]** the archive *.exe or *.zip file to the “**temp**” folder created earlier.
 - Otherwise, click **[Cancel]** to quit and exit the file download process.



- 2) Next, extract the firmware files from the archive file.
 - (If not already done with **File Download > [Open]**) Extract the firmware files from the downloaded *.exe or *.zip archive file with the user-supplied utility program:
 - Double-click on the archive file name, and then follow the prompts provided by the user-supplied utility program.

For the Base Modem update, a minimum of two files should be extracted:

- **FW-0020731*_CDM-625A_#.#.#.bin** – The base modem bulk image file (where ‘*’ is the revision letter).
- **CDM625A_ReleaseNotes_v#.#.#.pdf** (or a variation of this filename, where “###” is the firmware version).

For the IP Packet Processor update, a minimum of two files should be extracted:

- **Without AES – FW-0000342*.bin** (where ‘*’ is the revision letter) – or –
- **With AES – FW-000438x.bin** (where ‘*’ is the revision letter).
- **FW0000342*_CDM625A_ReleaseNotes_V#.#.#.pdf** (or a variation of this filename, where “#.#.#” is the firmware version).

3) Confirm availability of the firmware files in the temporary folder.

There are several ways you may view the contents of the temporary folder on a Windows-based PC:

A. From the Windows Desktop:

- Double-left-click the “**temp**” folder saved to the Windows Desktop.
- Use Windows Explorer to locate, and then double-left-click the “**temp**” folder.
- Use the Browse window ([**Start**] > ...**Run** > [**Browse**]) to locate, and then double-click the “c:\temp” folder.

B. Using Command-line:

- Type “**cd c:\temp**” at the Command-line prompt to change to the temporary directory created earlier using Command-line.
- Type “**dir**” to list the files extracted to the temporary directory from the downloaded archive file.

You have successfully downloaded the firmware files and they are now available for FTP transfer to the CDM-625A.

4.3.3 Perform the Ethernet FTP Upload Procedure



You may proceed with the firmware update procedure assuming that:

- Your CDM-625A is connected to a user-supplied, Windows-based PC, and:
 - Your PC serial port is connected to the CDM-625A “Remote Control” port with a standard user serial cable.
 - Your PC Ethernet port is connected to a CDM-625A “10/100 Ethernet” port with a user-supplied hub, switch, or direct Ethernet cable connection.
 - Your PC is running a terminal emulation program (for operation of the CDM-625A Serial Interface) and a compatible Web browser (for operation of the CDM-625A HTTP Interface).
- Your CDM-625A firmware and Ethernet Traffic/Management IP Address has been noted using either the CDM-625A Serial Interface or the CDM-625A HTTP Interface ‘Admin | Firmware | Base Modem’ and ‘Configuration | LAN | IP’ pages, respectively.
- The latest firmware files have been downloaded or otherwise received from Comtech EF Data and are available on the User PC in an accessible temporary folder.

1) Send a “ping” command to confirm proper connection and communication between the User PC and the CDM-625A:

- **Use Command-line:** Type “ping xxx.xxx.xxx.xxx” at the Command-line prompt (where ‘xxx.xxx.xxx.xxx’ is the unit Ethernet Traffic/Management IP Address).
- You may alternately use the CDM-625A HTTP Interface ‘Admin | Utilities’ page, as shown in this example:



For either method, the response should confirm whether the unit is properly connected and communicating.

2) Use Command-line to transfer (FTP) the files from the User PC to the CDM-625A:

- A. Type "**ftp xxx.xxx.xxx.xxx**" (where '**xxx.xxx.xxx.xxx**' is the CDM-625A Ethernet Traffic/Management IP Address).
- B. If the optional IP Packet Processor is **installed and enabled**, enter the User Name and Password when prompted. The default User Name and Password is "**comtech**". Otherwise, press **ENTER**.
- C. Type "**bin**" at the **ftp>** prompt to set the binary transfer mode.
- D. Type "**prompt**" and then "**hash**" at the **ftp>** prompt to facilitate the file upload.
- E. To begin the file transfer, at the **ftp>** prompt:
 - If the IP Packet Processor is not installed or is installed but disabled:

Type "**put FW-0020731*_CDM-625A_#.#.#.bin bulk:**" (where '*' is the revision letter and #.#.# is the version number) to begin the file transfers – the destination "**bulk:**" must be all lower case.
 - If the IP Packet Processor is installed and enabled:

Type "**put FW-0020731*_CDM-625A_#.#.#.bin**" (make sure you do **not** type the destination "**bulk:**" as is done for the Base Modem w/o IP Packet Processor upload option).
- F. For either option, it may take up to several minutes transfer the file. Once the file transfers, Command-line displays the upload result, similar to:
- G.

```
200 Port command okay
150 Opening data connection.
226 File received OK - XXXXXXXX bytes in XX.XXX sec
ftp: XXXXXXXX bytes sent in XX.XXSeconds XXX.XXXKbytes/sec.
```



In the event you receive the "Connection closed by remote host." message, wait another minute before continuing. The firmware upload sometimes takes longer than the FTP client allows.

- H. As the upgrade process continues, the modem front panel displays:

```
Programming bulk flash - (Block ID)...
Please wait...
```

The process sequences through several blocks – this may take several minutes. Once the update process is complete, the modem front panel displays:

```
Bulk FTP done. Press CLEAR.
```

Press the front panel **CLEAR** key as prompted.

- I. Type **"bye"** at the **>ftp** prompt to terminate the FTP session, and then close the Command-line window.
- 3) Use the modem front panel menus, the CDM-625A HTTP Interface **'Admin | Firmware | Base Modem'** page, or issue the Serial Remote Interface **<0/SWR?** or **<0/FRW?** query, as shown previously, to verify that the PC-to-Modem FTP file transfer was successful.



If you are a Base Modem user, the CDM-625A is now operating with its latest firmware and you may skip to Step 6. However, if you are running a CDM-625A with the optional IP Packet Processor installed, do NOT reboot at this time – once you have uploaded the base modem firmware you must proceed to the next step (Step 4) to upload the IP Packet Processor firmware.

- 4) **To upload the IP Packet Processor firmware** – Use Command-line to initiate the FTP session with the modem.
 - A. Type **"ftp xxx.xxx.xxx.xxx"** (where **"xxx.xxx.xxx.xxx"** is the CDM-625A Traffic/Management IP Address).
 - B. Enter the **Admin User Name** and **Password** to complete login.
 - C. Type **"bin"** at the **>ftp** prompt to set the binary transfer mode.
 - D. Type **"prompt"**, and then type **"hash"** at the **>ftp** prompt to facilitate the file upload.
 - E. Type **"put FW-#####X.bin"** (where **'#####'** is the pertinent image FW file number – **0000342** or **0000438** – and **'*'** is the revision letter) to begin the file upload.

It may take several minutes to transfer and write the files to flash memory. The PC should report that the upload result similar to the example shown in Step 2.

- F. The modem front panel should now display the IP Packet Processor firmware update process:

```
Packet Processor upgrading Bootrom  
Please wait...
```

```
Packet Processor upgrading Image  
Please wait...
```

Once the update is complete, the modem front panel will display:

```
Packet Processor upgrade complete  
Press CLEAR to continue.
```

Press the front panel **CLEAR** key as prompted.

- G. Type "bye" to terminate the FTP session, and then close the Command-line window.
- 5) Use the modem front panel menus, the CDM-625A HTTP Interface 'Admin | Firmware | Packet Processor' page, or issue the Serial Remote Interface <0/SWR? or <0/FRW? query as shown previously, to verify that the PC-to-Modem IP Packet Processor firmware FTP file transfer was successful.
- 6) Use the modem front panel menus, or the CDM-625A HTTP Interface 'Admin | Firmware | Base Modem' or, as needed, 'Admin | Firmware | Packet Processor' page to select the desired firmware image to boot from:

A. Using the modem front panel menus:

- First, to select the desired Boot Image, make sure that you are operating in **LOCAL** mode (**CONFIG: Remote → Local**).
- Then, go to the **SELECT: Utilities → Firmware → Base-modem → Select** menu branch and use the **▲ ▼** arrow keys to select the **Next Reboot Image** as **1** or **2**.
- Press **ENTER** when done.

B. Using the CDM-625A HTTP Interface: Typical for either 'Admin | Firmware' page, use the drop-down list to select **Image#1** or **Image#2**. Click [**Submit**] to save.

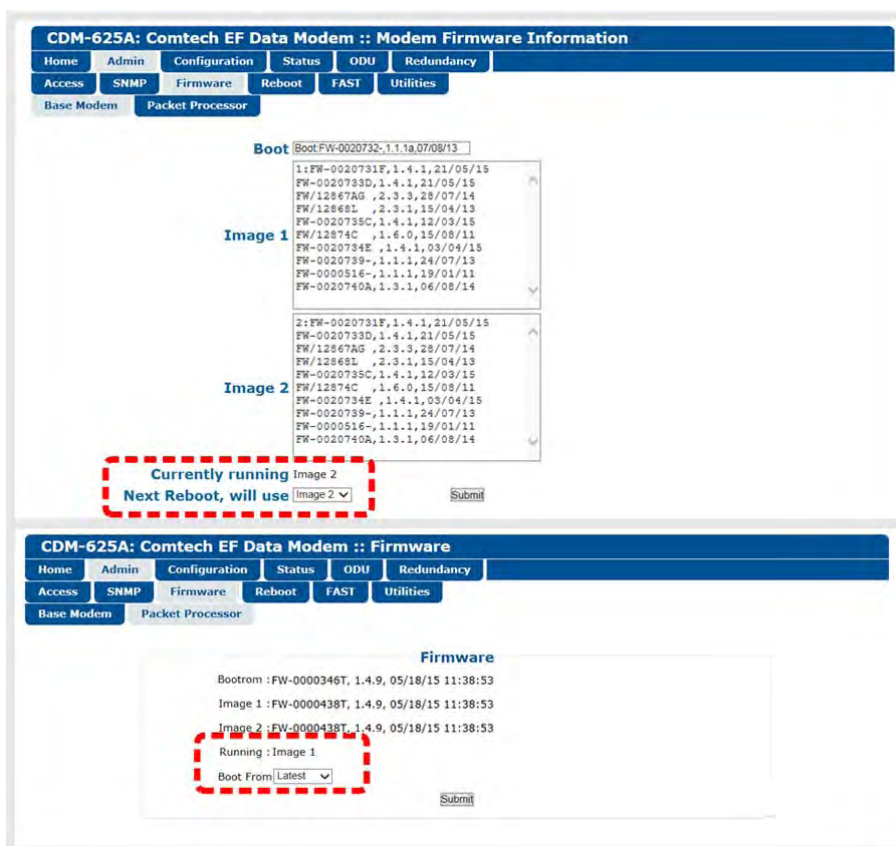

- 7) Reboot the CDM-625A. You may perform a 'soft reboot' or a 'hard reboot' as follows:
- Using the CDM-625A HTTP Interface '**Admin | Reboot**' page, click [**Reboot Now**]. Both the web page and the modem front panel will display "**Rebooting, Please wait...**"
 - From CDM-625A rear panel, turn off or otherwise disconnect, and then turn on/reconnect the power source to execute reboot of the modem.

The system reboot is complete once the modem front panel displays the top-level "splash" screen:

```
Comtech CDM625A Advanced Satellite Modem
PktP, VFEC-2 present                Ver1.4.1
```

You will need to log in to a new Web session at this time. The CDM-625A HTTP Interface '**Home**' page will serve to verify that the new firmware version is active, as shown in this example:

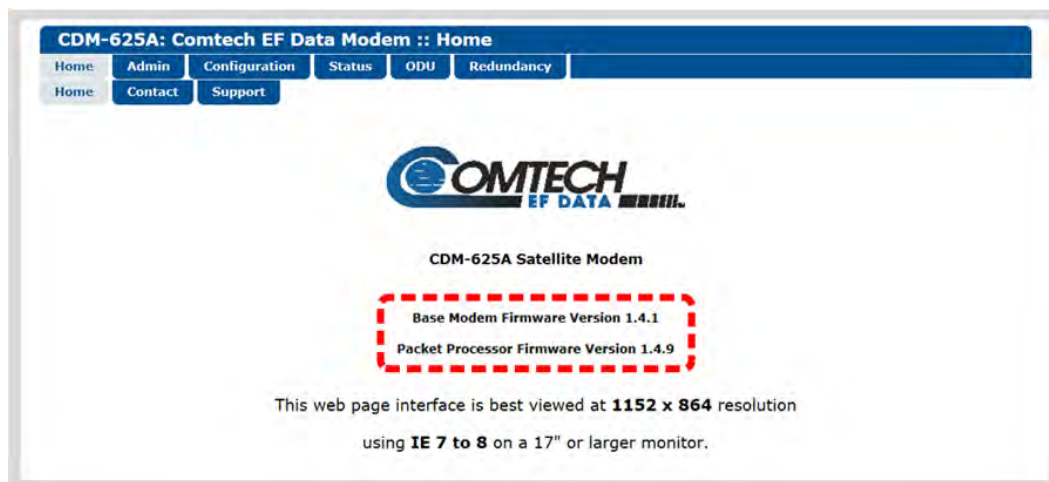

The CDM-625A is now operating with its latest firmware. The firmware update process is now complete.

Chapter 5. FAST ACTIVATION PROCEDURE

5.1 Overview

The CDM-625A Advanced Satellite Modem incorporates a number of optional features. In order to permit a lower initial cost, you may purchase the unit enabled with only the desired features.

If you wish to upgrade the functionality of a unit at a later date, Comtech EF Data provides **Fully Accessible System Topology (FAST)**, which permits the purchase and activation of options through special authorization codes. You may contact Comtech EF Data Product Support to purchase these unique, register-specific **Fast Access Codes**, and then load these codes into the unit using either the front panel keypad or the CDM-625A HTTP (Web Server) Interface.



See **Table 1-2 in Chapter 1. INTRODUCTION** or **Sect. 6.2.8.1.1 in Chapter 6. FRONT PANEL OPERATION** for listings of the available FAST and FAST-accessible hardware options.

FAST System Theory: FAST facilitates on-site upgrade of the operating feature set without removing a unit from the setup. FAST technology allows you to order a unit precisely tailored for the initial application. When your service requirements change, you can upgrade the topology of the unit to meet these requirements within minutes. This accelerated upgrade is possible because of FAST's extensive use of the programmable logic devices incorporated into Comtech EF Data products.

FAST Implementation: Comtech EF Data implements the FAST system in the modem at the factory. All FAST options are available through the basic platform unit at the time of order – FAST allows immediate activation of available options, after confirmation by Comtech EF Data, through the CDM-625A HTTP (Web Server) Interface.

FAST Accessible Options: You may order hardware options for installation either at the factory, or you can install and activate them on-site. The FAST Access Code that you purchase from Comtech EF Data enables configuration of the available hardware. The base CDM-625A unit is equipped with Viterbi and Reed-Solomon codecs. It offers BPSK, QPSK, and OQPSK modulation types, and data rates up to 5.0 Mbps, with all interface types. While it is limited to Closed Network operation, it also includes EDMAC and AUPC.

5.2 FAST Activation Procedure

5.2.1 FAST Activation Using the CDM-625A Front Panel



See Chapter 6. FRONT PANEL OPERATION for complete information about using this interface.

- 1) Before you contact Comtech EF Data Product Support to order FAST feature upgrades, you must retrieve the modem's motherboard serial number:

- A. From the front panel main menu, **SELECT: FAST**, and then press **ENTER**.

```
SELECT: Configuration Test Monitor
Info Store/Ld Utility ODU FAST (◀ ▶)
```

- B. The modem's 9-digit "Baseboard S/N" is displayed on the bottom line, to the left, as shown in this example:

```
FAST: Options Demo-Mode CnC
Baseboard S/N 123456789 HW Rev1.X Audio
```

- C. Write down the Serial Number: _____

- 2) View the currently installed FAST features:

- A. From the front panel main menu (shown in Step 1A), use the ◀▶ arrow keys to select the **FAST** menu branch, and then press **ENTER**. Then, use the ◀▶ arrow keys to select **Options** (shown in Step 1B). Press **ENTER** once more.

- B. From the **SELECT: FAST → OPTIONS** submenu:

```
FAST options: View Options
Set Register1 Set Register2 (◀ ▶ ⚡)
```

Use the ◀▶ arrow keys to select **View Options**, and then press **ENTER**.

- C. Use the ▲▼ arrow keys to scroll through the list of available FAST options. Options are identified as "Installed" or "Not Installed" as shown in this example:

```
FAST: View options: 01 (⚡)
Base 5 Mbps data rate installed
```

Any option identified as "Not Installed" may be purchased as a FAST upgrade.

- 3) Contact Comtech EF Data Product Support to order features:
 - A. Provide the unit Serial Number to the Product Support representative.
 - B. Identify and purchase the desired FAST option(s).
 - C. Obtain the invoice, the **register-specific** 20-digit FAST Access Code(s), and the FAST option activation instructions.



When a FAST Access Code is obtained from Comtech EF Data, it will be for a specific option register. The FAST options are linked to two option registers:

- **Register1 is for Data Rate, L-Band, and Framing options.**
- **Register2 is for Modulation type and Packet Processor options.**

- 4) Activate your purchased FAST features.
 - A. You must make sure you are active in the proper register.

From the **SELECT: FAST → OPTIONS** submenu, use the ◀▶ arrow keys to select **Set Register1** or **Set Register2**. Press **ENTER**.

```
FAST options:      View Options
Set Register1     Set Register2      (◀▶◆)
```

- B. Use the ▲▼◀▶ arrow keys to **carefully** enter each digit for your register-specific 20-character FAST Access Code. Press **ENTER** when done.

```
FAST: Set register#: Enter code below
88888888888888888888 then [ENTER] (◀▶◆)
```

The modem responds with “**Configured Successfully**” if the **FAST** upgrade is accepted; the modem then resets to its newly-incorporated default configuration.

However, if an invalid code is entered, the following message displays:

```
Failed to configure. Re-enter code.
88888888888888888888 then [ENTER] (◀▶◆)
```

Repeat the FAST Access Code entry procedure. Should the code entry error persist, contact Comtech EF Data Product Support for further assistance.

5.2.2 FAST Activation Using the CDM-625A HTTP (Web Server) Interface



See Chapter 7. ETHERNET-BASED REMOTE PRODUCT MANAGEMENT for complete information about using this interface.

CDM-625A: Comtech EF Data Modem :: FAST

Home Admin Configuration Status ODU Redundancy
Access SNMP Firmware Reboot FAST Utilities

FAST code

Register 1
Register 2

Demo Time Remaining: 30 days 0 hours 0 minutes
(Please reboot the modem after enabling the demo mode.)
Demo Mode

Equipment ID

Modem model number:	CDM-625A
Data Rate:	up to 25Mbps
TPC/LDPC data rate:	up to 25Mbps
CnC data rate:	up to 25Mbps
VersaFEC CCM data rate:	up to 16Mbps
VersaFEC ACM symbol rate:	up to 4100ksps
VersaFEC-2 CCM data rate:	up to 25Mbps
VersaFEC-2 ACM symbol rate:	up to 12500ksps
Installed Options	Options - Not Installed
VersaFEC-2 card Packet Processor card Audio chips Frequency: 70/140MHZ & L-band Modulation: BPSK, (O) QPSK, 8-ARY, 16-ARY, 32-ARY Framing: Standard, EDMACs & open netwtk D&I - four port (QDI) G.703 clock extension Header Compression: 25Mbps/12500ksps (ACM) Payload Compression: 25Mbps/12500ksps (ACM) Advanced QoS AES Encryption Advanced Network Timing Carrier ID CnC Activation	TPC/LDPC codec External 20dB Attenuator Time based CnC

Figure 5-1. CDM-625A HTTP Interface – ‘Admin | FAST’ page

Use the CDM-625A HTTP (Web Server) Interface ‘Admin | FAST’ page (Figure 5-1) for complete management of FAST Features. This page provides scrollable list boxes that display the availability and activation status for all FAST options. FAST code entry/option activation control is also provided.

- 1) Before you contact Comtech EF Data Product Support to order FAST feature upgrades, you must retrieve the modem’s motherboard serial number. Use the front panel **SELECT: FAST** menu, as explained in **Sect. 5.2.1 Step 1**, to obtain and record the modem’s motherboard serial number.

Write down the Serial Number: _____

- 2) View the currently installed FAST features: Use the '**Admin | FAST**' page (**Figure 5-1**) to view the currently installed features. Any options that appear in the scrollable **Options – Not Installed** list box may be purchased as a FAST upgrade.
- 3) Contact Comtech EF Data Product Support to order features:
 - A. Provide the unit Serial Number to the Product Support representative.
 - B. Identify and purchase the desired FAST option(s).
 - C. Obtain the invoice, the **register-specific** 20-digit FAST Access Code(s), and the FAST option activation instructions.



When a FAST Access Code is obtained from Comtech EF Data, it will be for a specific option register. The FAST options are linked to two option registers:

- **Register1 is for Data Rate, L-Band, and Framing options.**
- **Register2 is for Modulation type and Packet Processor options.**

- 4) Activate your purchased FAST features.
 - A. In the **FAST code** section of the '**Admin | FAST**' page, *carefully* enter the **register-specific** 20-character FAST Access Code into its designated text box (**Register 1** or **Register 2**) (each FAST Access Code is submitted separately). Click [**Submit**].
 - B. The message "**Configured Successfully**" appears at the top of the **FAST code** section if the **FAST** upgrade is accepted; the modem then resets to its newly-incorporated default configuration.

However, if an invalid code is entered, either of the following messages may appear instead:

FAST code has invalid format.
It is 20-digit and consists of only 0-9 and A-F.

FAST code is not correct.

Repeat the FAST Access Code entry procedure. Should the code entry error persist, contact Comtech EF Data Product Support for further assistance.

Notes:

Chapter 6. FRONT PANEL OPERATION

6.1 Overview

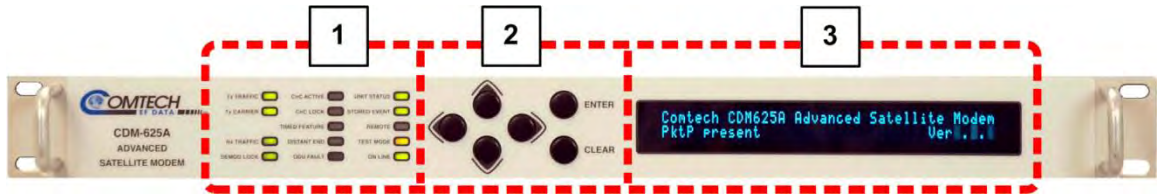

Feature	Description	Function	See Chapter Section...
1	LED Indicators	The LEDs indicate, in a summary fashion, the status of the modem.	6.1.1
2	Keypad	The keypad comprises six individual keyswitches. The keys have a positive 'click' action that provides tactile feedback. ENTER data via the keypad. Data, prompts, and messages are displayed on the VFD.	6.1.2
3	Vacuum Fluorescent Display (VFD)	The VFD is an active display showing two lines of 40 characters each. It produces a blue light with adjustable brightness. Nested menus (Figure 6-2) display all available options and prompt you to carry out a required action.	6.1.3

Figure 6-1. CDM-625A Front Panel Features

6.1.1 LED Indicators

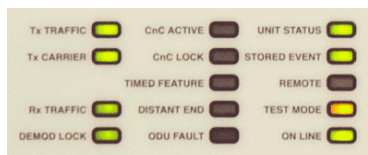

In general, the Alarm relay state reflects the state of the Front Panel LEDs. For example, if the Unit Status LED is red, the Unit Alarm relay is active, etc. The sole exception is the Transmit Traffic relay – it does not reflect the state of the Tx carrier; it activates only if a Transmit Traffic Fault exists.

The front panel LED indicators function as follows:

LED	State	Function
Tx (Transmit) TRAFFIC	Green	No Tx Traffic faults
	Off	A Tx Traffic fault exists (this is independent of the Transmit Carrier state – see TX Carrier LED)
Tx (Transmit) Carrier	Green	Tx Carrier is ON (reflects the true state of the Tx carrier, regardless of Tx Traffic state)
	Off	Tx Carrier is OFF
Rx (Receive) TRAFFIC	Green	No Rx Traffic faults (Demod/FEC decoder are locked, valid frame sync, if applicable, and no other Rx traffic alarms)
	Off	An Rx Traffic fault exists (frame sync alarm, etc - the demod may still be OK – see Demod Lock LED)
DEMOD LOCK	Green	The demodulator and FEC decoder are locked
	Off	The demodulator and/or FEC decoder are not locked
CnC ACTIVE	Green	CnC Mode is active
	Off	CnC Mode is not active
CnC LOCK	Green	CnC Mode is active and the CnC algorithm has converged and locked
	Off	If CnC Mode is active, the CnC algorithm has not converged and locked
TIMED FEATURE	Green	Demo Mode is active or Time Limited CnC is active with > 15 days left before expiration or Fractional CnC is active, but unit is offline
	Red	Time Limited CnC or Fractional CnC allowed time has expired
	Orange	Fractional CnC is active, unit is online with < 15 days left before expiration
	Off	No time limited feature enabled. (will also turn off after Demo Mode time has expired)
DISTANT END	Green	CnC-APC or IP-ACM or V2-ACM or EDMAC mode is active, and distant-end demod is locked
	Orange	CnC-APC or IP-ACM or V2-ACM or EDMAC mode is active, and distant-end demod is not locked
	Off	CnC-APC or IP-ACM or V2-ACM or EDMAC is active, and local demod is unlocked

LED	State	Function
ODU FAULT	Red	BUC or LNB or CSAT or KST fault detected
	Flashing	Communication fault with BUC or CSAT or KST
	Off	BUC or LNB or CSAT or KST no fault detected
UNIT STATUS	Green	No Unit Faults or Traffic Faults
	Orange	No Unit Faults, but a Traffic Fault exists
	Red	A Unit Fault exists (Example: PSU fault)
STORED EVENT	Orange	There is a Stored Event in the log, which can be viewed from the front panel, or retrieved via the remote control interface
	Off	There are no Stored Events
REMOTE	Orange	The Unit is in Remote Mode – local monitoring is possible, but no local control
	Off	The Unit is in Local Mode – remote monitoring is possible, but no remote control
TEST MODE	Orange	A Test Mode is selected (Example: IF Loopback)
	Off	There is no Test Mode currently selected
ONLINE	Green	The Unit is Online and carrying traffic
	Off	The Unit is Offline (Standby) – forced by externally connected 1:1 or 1:N redundancy system

6.1.2 Keypad



The keypad has an auto-repeat feature. When you hold down a key for more than one second, the key action repeats, automatically, at the rate of 15 keystrokes per second. This is particularly useful when editing numeric field with many digits, such as frequency or data rate.

The keypad functions as follows:

Key	Description
ENTER	Use this key to display the nested menu for a selected function, or to execute (save) a configuration change.
CLEAR	Use this key to back out of a selection or to cancel a configuration change that has not been executed using ENTER . Press CLEAR to return to the previous menu screen.
◀ ▶ (Left, Right)	Use these keys to navigate between available selections, or to move the cursor position, on any menu screen.
▲ ▼ (Up, Down)	Use these keys primarily to change the alphanumeric selection (i.e., numbers for configuration data, letters for text strings) at the current cursor position, or to scroll through pre-defined parameter settings that may be provided at the current cursor position.

6.1.3 Vacuum Fluorescent Display (VFD)



The CDM-625A features a Vacuum Fluorescent Display (VFD). The VFD is an active display showing two lines of 40 characters each. It produces a blue light with adjustable brightness. Compared to a Liquid Crystal Display (LCD), the VFD provides superior viewing characteristics and does not suffer problems of viewing angle or contrast.

On most menu screens, you will observe a flashing solid block cursor, which blinks at a once-per-second rate. This indicates the currently selected menu item, digit, or field. Where this solid block cursor would obscure the item being edited (e.g., a numeric field) the cursor automatically changes to an underline cursor.

6.1.3.1 Screen Saver

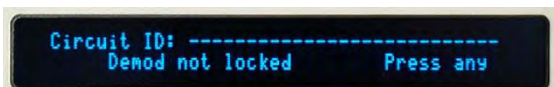

If the operating unit is left displaying the same screen for weeks at a time, the VFD could become burnt with this image. To prevent such

burn-in, a screen saver feature activates after one hour. The screen saver messages loop from right to left across the screen. The top line of the display shows the user-editable Circuit ID; the bottom line shows the current status of the modem followed by the message 'Press **any key...**' as shown here. *Press any key to restore the previous screen.*

6.1.3.2 Opening Screen

The front panel displays provide the means to fully monitor and control modem operation. Once you turn on the power, you will see the **read-only** opening screen:

```
Comtech CDM625A Advanced Satellite Modem
Ver1.4.1
```

This screen identifies the modem model, its installed firmware version, and information about installed hardware options. From any other nested menu, press **CLEAR** repeatedly to access this screen.

6.1.3.2.1 Feature Availability/Operation Indicators via the Opening Screen

```
Comtech CDM625A Advanced Satellite Modem
TPC, PktP, VFEC-2 present Ver1.4.1
```

- **TPC/LDPC** – The screen displays **TPC** when you install this hardware option.



- **Sect. 7.6 Turbo Product Codec (Hardware Option)**
- **Sect. 7.7 TPC and Low Density Parity Check (LDPC) coding**

- **IP Packet Processor Card** – The screen displays **PktP** when you install this hardware option.



Appendix L. IP PACKET PROCESSOR OPTION

- **VersaFEC-2** – The screen displays **VFEC-2** when you install this hardware option.



Appendix M. ADAPTIVE CODING and MODULATION (ACM) OPTION

- **CDM-600/600L Emulation Indication** – The CDM-625A serves as a ‘drop-in’ replacement product for CDM-600 and CDM-600L modems. Comtech EF Data provides an emulation mode to accomplish this design intent. You may configure this mode via the front panel (**SELECT: Utility→Em**) or by remote control (remote command **EMU=**).

When you select emulation, the CDM-625A opening screen displays this mode of operation, as this example shows:

```
Comtech CDM625A      emulating a CDM-600
TPC, PktP present    Ver2.2.6
```

Note that, while emulating a CDM-600 or CDM-600L modem, the I/O responses (including that of remote query **EID?**) replicate those of the emulated modem; further, the firmware version number displayed on the opening screen, and the response from remote query **SWR?** reflects that of the emulated modem’s firmware version number.

- **Warm-up Delay Mode counter** – When you select the warm-up delay mode, the modem turns the carrier *off* during the warm-up time, and the bottom line of the screen displays the countdown message:

```
Comtech CDM625A      emulating a CDM-600
High-Stability Ref  warming up:  009 sec
```

6.2 SELECT: (Main) Menu

```
SELECT: Configuration Test Monitor
Info Store/Ld Utility ODU FAST (◀ ▶)
```

Figure 6-2 shows the hierarchal structure of the CDM-625A principle menu tree from the **SELECT:** menu on down.

Press **ENTER** or **CLEAR** to immediately access the **SELECT:** menu screen from the opening screen. From any nested menu, press **CLEAR** repeatedly until this screen reappears.

The table that follows identifies each menu branch available from the **SELECT:** menu and its content section in this chapter. Functionality of each menu sub branch is further explained in the subsequent chapter sections.

Menu Branch	Sect.	Function
Configuration	6.2.1	Use to fully configure the modem.
Test	6.2.2	Use to configure the modem into one of several Test modes, and to configure/monitor the BER Tester.
Monitor	6.2.3	Use to monitor the current status of the modem and to view the log of stored events for the modem.
Info	6.2.4	(Information) Use to view information on the modem without having to access the Configuration screens.
Store/Ld	6.2.5	(Store/Load) Use to store and retrieve up to 10 different modem configurations.
Utility	6.2.6	Use to configure various operational functions – e.g., setting the Real-Time Clock, adjusting the VFD brightness, etc.
ODU	6.2.7	(Outdoor Unit) <i>Depending on 70/140 MHz or L-Band operation:</i> Use to monitor and control a standalone or redundant Comtech EF Data RF Transceiver (CSAT-5060 or KST-2000A/B) or LPOD BUC, if connected. See Chapter 10. CDM-625A ODU (TRANSCEIVER, BUC, LNB) OPERATION for full details.
FAST	6.2.8	(Fully Accessible System Topology) Use to configure available options – e.g., extended data rates, interfaces, etc. Contact Comtech EF Data Product Support for details. See Chapter 5. FAST ACTIVATION PROCEDURE for additional information.



The actual selections displayed in the submenus may vary according to which FAST options have been activated and enabled. Where a FAST option affects a menu, this displays in the descriptive text.

Use the ◀▶ arrow keys to select a menu branch from this top-level **SELECT:** menu. Press **ENTER** to continue.

 = Icon indicates menu appearance, and availability of nested menus, when Carrier-in-Carrier (CnC) is active

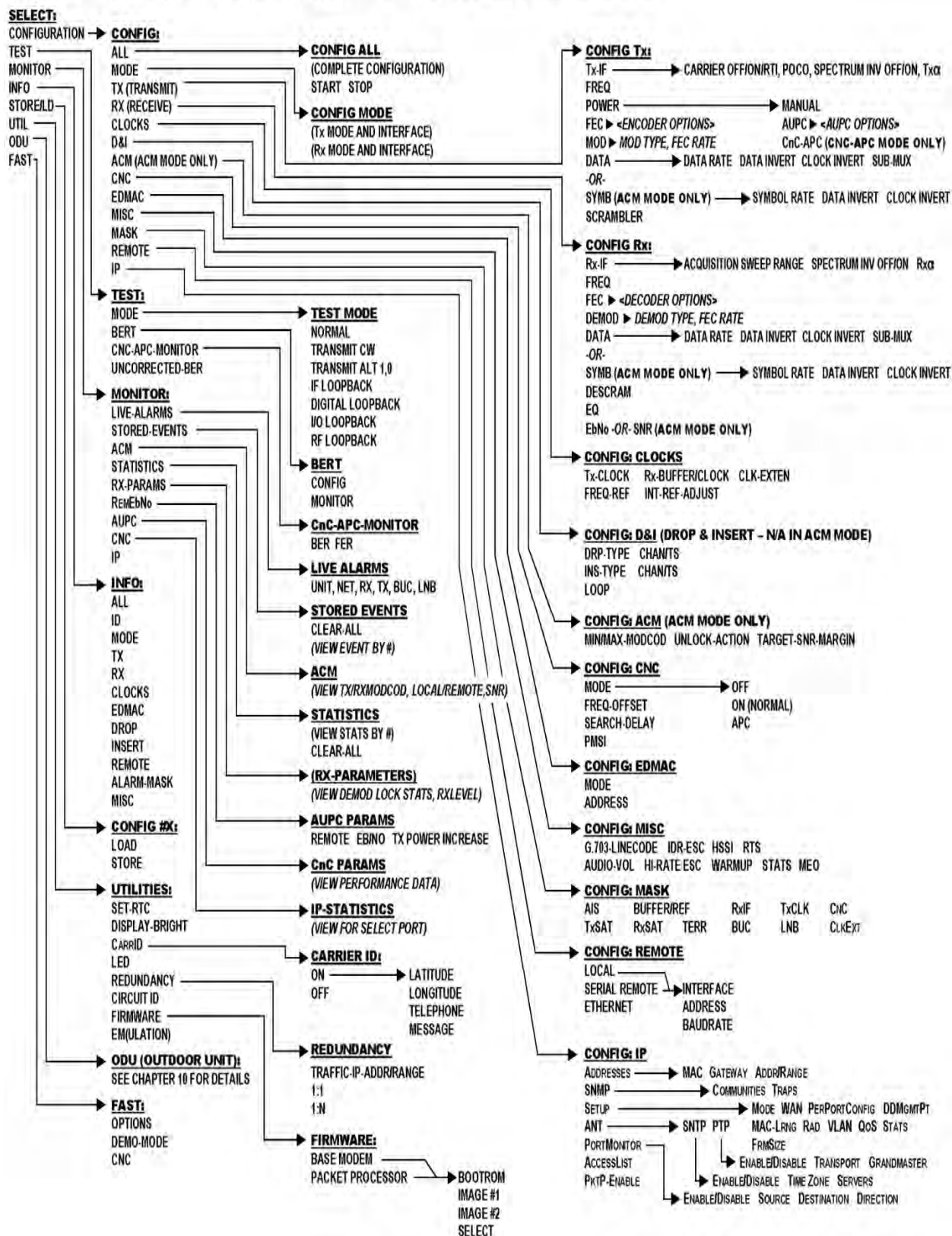

Figure 6-2. CDM-625A Principle Menu Tree (FW Ver. 1.4.1)

6.2.1 SELECT: CONFIG (Configuration) Menu Branch

```
CONFIG: All Mode Tx Rx Clocks D&I/ACM
CnC EDMAC Misc Mask Remote IP (◀ ▶)
```

Use the ◀▶ arrow keys to select a submenu. Press **ENTER**. Valid selections are:

Submenu	Sect.	Function
All	6.2.1.1	This submenu is highly recommended for new users, as it leads you through the complete modem configuration process on a step-by-step basis.
Mode	6.2.1.2	Use to select Frame Type and Data Format for Tx and Rx.
Tx	6.2.1.3	(Transmit) Use to define the Tx configuration of the unit. These menu submenu branches would be used if you wished to change, for example, just the Tx Frequency.
Rx	6.2.1.4	(Receive) Use to define Rx configuration of the unit. These menu submenu branches would be used if you wished to change, for example, just the Rx data rate.
Clocks	6.2.1.5	Use to select Tx-Clocking, Rx-Buffer/Clock, or External Reference.
D&I	6.2.1.6	Use to select (Quad) Drop & Insert options (NOT AVAILABLE IN ACM MODE).
ACM	0	(VersaFEC® Adaptive Coding and Modulation) Use to configure ACM operating parameters. (AVAILABLE, IN PLACE OF D&I SUBMENU, ONLY IN ACM MODE).
CnC	0	(DoubleTalk Carrier-in-Carrier) Use to select DoubleTalk Carrier-in-Carrier (CnC) options.
EDMAC	0	Use to select EDMAC options.
Misc	6.2.1.10	(Miscellaneous) Use to select, view, or change various other parameters.
Mask	6.2.1.10.9	Use to activate or MASK an alarm condition.
Remote	6.2.1.12	(Remote Control) Use to define whether the unit is being controlled locally, remotely, or via IP, and to configure the serial Remote Control parameters: baud rate, I/O format, address.
IP	6.2.1.13	Use to configure various IP parameters, including IP address, gateway, MAC addresses, VLAN, and QoS.



You may always view the front panel operations and monitor the modem over the remote control bus (i.e., queries only); however, only one method of remote access may control the modem at any given time:

- You must be in **Local Mode** to make configuration parameter changes from the front panel. **Remote Mode** is required when using **Serial-based remote M&C**.
- You must be in **Ethernet Mode** when using **Ethernet-based remote M&C over IP**.

6.2.1.1 CONFIG: All

All = Stop
(Stop, Start)

Use this menu to configure the unit on a step-by-step basis. Every available configuration menu displays in succession.

First, use the ▲ ▼ arrow keys to select **Stop** or **Start**. Press **ENTER** to execute.

Then:

- Use the ◀ ▶ arrow keys to select, and the ▲ ▼ arrow keys to edit, configuration parameters as needed.
- Press **ENTER** to continue through all the configurations.
- Press **CLEAR** to discontinue.

Configuration Notes:

6.2.1.2 CONFIG: Mode



MODE is a key parameter when configuring the modem. To simplify the menu selections, you must first determine the INTERFACE and FRAMING type for both Transmit and Receive. Once these have been selected, you are presented only with menu selections that are applicable to those particular modes. For example:

- When you select a G.703 interface, the data rate menu is restricted to only the appropriate G.703 rates.
- When you select an IDR framing mode, the data rate selections are limited to only those rates specified by IESS-308.

```
Mode : Tx=RS422 :NONE   Rx=RS422 :None
      (422 ,V35 ,G703s ,Audio ,LVDS ,HSSI ,IP ,ASI)
```

This screen example depicts an **Interface Type** menu screen. You may select **Interface Type** and **Framing** for both **Tx** and **Rx** from this menu. Use the ◀▶ arrow keys to select the parameter to edit. The bottom line indicates the available options for the active parameter. Not all options are always available – they depend on other settings or on the modem’s activated **FAST** options.

The first parameter is the **Interface Type**. Available options are:

- | | | |
|-----------------------|-----------------------|---------|
| ▶ IP | ▶ RS422 | ▶ V.35 |
| ▶ ASI | ▶ G.703x: | ▶ Audio |
| ▶ IP-ACM | • G.703B (Balanced) | ▶ LVDS |
| ▶ V2-ACM (VersaFEC-2) | • G.703U (Unbalanced) | ▶ HSSI |

Use the ▲▼ arrow keys to scroll through the available options. Press **ENTER**.

If the cursor is on the second parameter – the **Framing Type** – the display appears as shown:

```
Mode : Tx=RS422 :NONE   Rx=RS422 :None
      (None IBS IDR D&Is EDMACs ESV++)
```

Interface Notes:

- 1) The **IP-ACM** and **V2-ACM** mode choices limit available framing types to **NONE** or **EDMAC**.



Appendix M. ADAPTIVE CODING AND MODULATION (ACM)

- 2) The list of available Interface Types includes **Audio** when a unit ships with the *Two Channel Audio Drop Hardware Option* installed. The **Audio** mode choice permits you to carry 2 x 32 kbps ADPCM audio as the primary data. This mode restricts the available framing types to **IBS** or **EDMAC** (see the selection table and the explanations on the next page).

Use the ▲▼ arrow keys to scroll through the available options. Press **ENTER**.

Available Framing Types are:

FRAMING TYPE	COMMENTS
▶ None	---
▶ IBS (FAST option)	---
▶ IDR (FAST option)	---
▶ D&Is (Drop & Insert) (FAST option) <i>which includes:</i>	
• D&I (FAST option)	The D&I (Drop and Insert) multiplexer works in conjunction with the G.703 interfaces to enable the modem to transmit or receive fractional parts of a T1 or E1 data stream.
• D&I++ (FAST option)	D&I++ is a Comtech EF Data proprietary framing – it is a closed-network frame structure similar to D&I, but which permits AUPC and EDMAC. See Appendix E. CLOCK MODES and DROP & INSERT (D&I) for further information.
• QDI (Quad Drop & Insert) (FAST option)	QDI is a variant of D&I that allows use of up to four E1 terrestrial ports.
• Framed QDI (FAST option)	Framed QDI is a concatenation of QDI and EDMAC framing.
• D&I Enhanced	Available in E1-CCS; this allows enabling of ESC, and then AUPC.
▶ EDMACs <i>which include:</i>	
• EDMAC	EDMAC is a Comtech EF Data proprietary framing. It is backwards compatible with the CDM-500, CDM-550, CDM-550T, CDM-600 and CDM-600L. The framing permits bi-directional passing of M&C and AUPC (Automatic Uplink Power Control) data between local and distant-end units.
• EDMAC-2 (as in the CDM-570)	EDMAC-2 is a reduced overhead version of EDMAC, and is not completely backwards compatible with the modems listed above, but is in some modes (e.g., in Turbo BPSK modes and at rates above 2.048 Mbps). See Appendix H. EDMAC CHANNEL for further information.
• EDMAC-3	EDMAC-3 uses the same overhead as EDMAC framing, but the EDMAC channel operates at 1/3 the rate of original EDMAC. Most of the overhead is dedicated to carrying the remote modem's complete status information (including AUPC) to the near-end modem very quickly. Tailored to SNMP proxy applications. See Appendix H. EDMAC CHANNEL for further information.
▶ ESC++	ESC++ is Comtech EF Data proprietary framing – it is a closed-network frame structure that permits AUPC, EDMAC and ESC. See Appendix J. ESC++ for further information.

6.2.1.3 CONFIG: Tx

```
Tx-IF Freq Power FEC Mod Data Scrambler  
(Data 00192.000kbps, 00131.657ksps) (◀ ▶)
```

On the top line – Use the ◀▶ arrow keys to select a parameter. Press ENTER.

On the bottom line – *Read-only* Data and Symbol rate information is provided.



When Sub-Mux is ON, Composite Rate information replaces the Data Rate information on the bottom line of this display.

6.2.1.3.1 CONFIG: Tx → Tx-IF

```
Tx: Carrier=On (Off,On,RTI) POCO=Off  
SpectrumInvert=Off Txα=.35 (.05-.35) (◀ ▶ ⚡)
```

Use the ◀▶ arrow keys to select a parameter. Press ENTER.

- **Carrier** – Use the ▲▼ arrow keys to select a parameter. Press ENTER.



USE THE RTI FEATURE WITH EXTREME CARE! RTI (RECEIVE/TRANSMIT INHIBIT), when selected, prevents transmission of the Tx carrier until the demodulator is locked. To avoid shutdown of the Tx Carrier when the demodulator loses lock for a very short duration, before the transmit carrier is inhibited the demodulator must be unlocked continuously for the selected time period (1, 2, 4, 7, or 10 seconds).

Enabling RTI does not affect the Internal IF Loopback feature. However, be aware that, if an External IF Loopback is attempted (i.e., connecting an external cable from the Tx IF output to the Rx IF input), this will not work! (The Tx carrier cannot turn on until the demod is locked – the demod cannot lock because the Tx output is off. The net result is that the demod will not lock and the Tx carrier will not turn on.)

- **POCO (Power-On Carrier-Off)** – When enabled (selected as **ON**), this feature overrides the Tx setting to **OFF** in the event of a power-cycle of the modem. **Use with caution.**



SPECTRUM INVERT should normally be in the OFF position. For all FEC types except BPSK, when Spectrum Invert is in the ON position the transmit spectrum is inverted (which is the same as reversing the direction of phase rotation in the modulator). In BPSK, the time-order of bits out of the FEC encoder is reversed to make the modem compatible with certain other manufacturer modems.

- **Tx α (Tx Alpha Filter Rolloff Factor)** – Use the **▲▼** arrow keys to select the **Tx α** . Press **ENTER**. Valid settings are:

Tx α (Tx Alpha rollout Factor) (%)	Default
0.05, 0.10, 0.15, 0.25	0.35



The Rx α of the corresponding receiver must match the Tx α – see Sect. 6.2.1.4.1 for details. To summarize:

- Set Rx α = 0.35 if Tx α \geq 0.25;
- Set Rx α = 0.12 if Tx α \leq 0.20.

6.2.1.3.2 CONFIG: Tx \rightarrow Freq (Frequency)

```
Tx-IF Frequency:    0050.0000 MHz      ( ◀ ▶ ◆ )
```

To edit the Tx-IF Frequency, use the **◀▶** arrow keys to select a digit, and then use the **▲▼** arrow keys to change that digit. Press **ENTER**. Valid settings are:

IF Frequency	Range	Step Size (Increment)
70/140 MHz	50-180 MHz	100 Hz
L-Band (FAST Option)	950-2250 MHz	100 Hz

When you use the ODU menus to configure a BUC lockout frequency, this screen displays a second line of information:

```
Tx-IF Frequency:    1750.0000 MHz
(LO:12500 MHz  Sat:14250.0000 MHz) ( ◀ ▶ ◆ )
```

As you edit the IF frequency, the Satellite frequency updates accordingly.



Satellite frequency = LO \pm IF frequency, where the sign \pm is determined by the LO mix parameter:

- High-sided mix [-] (includes a spectral inversion);
- Low-sided mix [+].

6.2.1.3.3 CONFIG: Tx → Power

```
Output Power: Mode= Manual (Manual,AUPC)
Level= -20.0 dBm (◀ ▶ ⬆)
```

Use the ◀▶ arrow keys to select the Output Power **Mode** (top line) or to edit the Output Power **Level** (bottom line). Press **ENTER**.

On the top line – Use the ▲▼ arrow keys to set the Output Power Mode as **MANUAL** or **AUPC** (see the next section for selection conditions).

On the bottom line – Edit the Output Power Level by using the ◀▶ arrow keys to select a digit. Then, use the ▲▼ arrow keys to change that digit. Valid settings are:

Tx Frequency	Minimum Output Power Level	Maximum Output Power Level
70/140 MHz (50-180 MHz)	0 dBm	-25 dBm
L-Band (FAST Option) (950-2250 MHz)	0 dBm	-45 dBm

6.2.1.3.3.1 CONFIG: Tx → Power → Mode → AUPC



Appendix C. AUTOMATIC UPLINK POWER CONTROL (AUPC)

You may select the **AUPC** Output Power Mode only when the Tx framing is **EDMAC**, **D&I++**, **ESC++** or **D&I**. Note that you do not require a framed mode when in IP-ACM or V2-ACM mode. Otherwise, if you attempt to select the Output Power Mode as **AUPC**, the modem blocks this selection and displays this message on the bottom line:

```
Output Power: Mode= AUPC (Manual,AUPC)
! AUPC needs supporting framing mode !
```

Once you select an appropriate framing type, the bottom line appears as follows:

```
Output Power: Mode= AUPC (Manual,AUPC)
Target-EbNo-Range Alarm-Action (◀ ▶ ⬆)
```

However, with **CONFIG: Mode** set to IP-ACM or V2-ACM mode, the bottom line appears as follows:

```
Output Power: Mode= AUPC (Manual, AUPC)
Mode/range Alarm Action (◀ ▶ ⬆)
```

Use the ◀▶ arrow keys to select **Target-EbNo-Range** or **Mode/range** (when in IP-ACM or V2-ACM mode), or **Alarm Action**. Press **ENTER**.

CONFIG: Tx → Power → Mode → AUPC → Target-EbNo-Range

```
Minimum EbNo of Remote Modem = 5.0dB
Max Permitted Power Increase = 9dB ( ◀ ▶ ◆ )
```

On the top line – Edit the Target Eb/No of the remote modem by using the ◀▶ arrow keys to select a digit. Then, use the ▲▼ arrow keys to change that digit. Press **ENTER**. Valid settings are:

Upper Limit	Default
14.9 dB	3.0 dB

On the bottom line – Edit the maximum permitted increase in power level when in AUPC Mode by using the ◀▶ arrow keys to select a digit. Then, use the ▲▼ arrow keys to change that digit. Press **ENTER**. Valid settings are:

Upper Limit	Upper Limit When CnC is ON	Default
9 dB	6 dB	3 dB

CONFIG: Tx → Power → Mode → AUPC → Alarm-Action

```
Max Tx Pwr Action= None (None, Tx-Alm)
Rem Demod Unlock Act= Nom-Pwr (Nom,Max)
```

On the top line – Configure the action that occurs if the **AUPC** causes the maximum output power level to be reached. Use the ▲▼ arrow keys to select **None** or **Tx Alarm**. Press **ENTER**.

On the bottom line – Configure the action that occurs if the remote demod is unlocked. Use the ▲▼ arrow keys to select **Nom-Pwr** or **Max-Pwr**. Press **ENTER**.

Note that:

Setting	Function
Nom-Pwr (Nominal Power)	The output level reverts to the nominal power level set under Manual .
Max-Pwr (Maximum Power)	The output level changes to the maximum permitted.

When in IP-ACM or V2-ACM mode:

CONFIG: Tx → Power → Mode → AUPC → Mode/range

```
AUPC-ACM Mode:Normal (Normal,+/-Track)
Max Permitted Power Increase:3.0 dB ( ◀ ▶ ◆ )
```

In all cases except when MEO (Medium Earth Orbit) is enabled, the mode is fixed at **Normal**. On the bottom line, use the ▲▼ arrow keys to select the maximum permitted power increase:

Lower Limit	Upper Limit	Step size (Increment)
0.0 dB	6.0 dB	0.1 dB

CONFIG: Tx → Power → Mode → AUPC → Alarm-Action (IP-ACM or V2-ACM Mode)

```
Tx-Alarm: Max Power (MaxPwr,MinMCod,None)
Rem Demod Unlock Act=NomPwr (Nom,Max,Hold)
```

On the top line – Use the ▲▼ arrow keys to select the alarm action that occurs if the **AUPC** causes the maximum output power level to be reached. Valid settings are:

Setting	Alarm Function
MaxPwr	(Maximum Power) Generates alarm when maximum power is reached.
MinMCod	(Minimum ModCod) Generates alarm if minimum ModCod is reached.
None	Generates no alarm.

On the bottom line – Use the ▲▼ arrow keys to select the action that occurs if the remote demodulator is unlocked. Use the ▲▼ arrow keys to select a parameter. Valid settings are:

Setting	Function
Nom	(Nominal Power) The output level reverts to the nominal power level set under Manual .
Max	(Maximum Power)The output level changes to the permitted maximum.
Hold	The output level is maintained at the value just before the remote demod lost lock.

CONFIG: Tx → Power → Mode → CnC-APC Mode



Appendix F. Double Talk Carrier-in-Carrier Option

When you select CnC Automatic Power Control (CnC-APC) mode, this menu appears as shown:

```
Output Power Mode = CnC-Auto-Power-Control
Level=-25.0dBm MaxPwrIncrease=2.5dB (◀ ▶ ⬆)
```

On the bottom line – Edit the power output level and the maximum permitted increase in power level when in APC Mode. Use the ◀▶ arrow keys to select a digit, and then use the ▲▼ arrow keys to change that digit. Press **ENTER**.

Note that, when APC is in an active state, the power level values display in the bottom left as 'AUTO'.

6.2.1.3.4 CONFIG: Tx → FEC

```
Enc=Vit (Vit,Seq,TCM,TPC,LDPC,VFEC,ULL)
Reed-Solomon=On (Off, On) (◀▶◆)
```

Use the ◀▶ arrow keys to select **Encoder** or **Reed-Solomon** (or **Diff Encoder** – see Note 1 below). Press **ENTER**.

On the top line – Use the ▲▼ arrow keys to select an available Encoder option (shown in parentheses). Press **ENTER**. Valid selections are:

- ▶ **None** (i.e., uncoded)
- ▶ **TCM** (Trellis Coded Modulation)
8-PSK Rate 2/3 only (**FAST option**)
- ▶ **VFEC** (VersaFEC)
- ▶ **ULL** (VersaFEC Ultra-Low Latency)
- ▶ **Vit** (Viterbi)
- ▶ **TPC** (Turbo Product Codec)
(**Hardware option**)
- ▶ **VF2L** (VersaFEC-2 Long Block)
- ▶ **Seq** (Sequential)
- ▶ **LDPC** (Low Density Parity
Check) (**Hardware option**)
- ▶ **VF2S** (VersaFEC-2 Short Block)



- 1) **When you select None as the Encoder setting, the bottom line of the display changes from Reed-Solomon to Diff Encoder (Differential Encoding).**
- 2) **The TPC (Turbo) and LDPC encoding selections appear only when you install the TPC/LDPC hardware option.**

On the bottom line – When **Reed-Solomon** is selectable, use the ▲▼ arrow keys to select **On** or **Off**. Press **ENTER**.

CONFIG: Tx → FEC → Reed-Solomon On

```
Reed-Solomon Encoding =Standard(126/112)
(Standard(126/110), IESS-310(219/201)) (◆)
```

Use the ▲▼ arrow keys to select one of the listed parameters. Press **ENTER**.

With this display active, depending on the Framing mode, valid selections are:

- ▶ **IESS-310, open or closed network** 219/201
- ▶ **IBS or D&I** 126/112
- ▶ **EDMAC or EDMAC2, closed network** 200/180
- ▶ **IDR, open network** 225/205, 219/201 or 194/178
- ▶ **ESC++ or D&I++, closed network** 126/112
- ▶ **Unframed closed network:**
 - **Comtech standard** 220/200
 - **Legacy EF Data** 225/205, with V.35 scrambling

Otherwise, when **Diff Encoder** is selectable on the bottom line:

CONFIG: Tx → FEC → Diff Encoder On

```
Enc=None (Vit, Seq, TCM, TPC, LDPC, VFEC, ULL)
Diff Encoder=On (Off, On) (◀ ▶ ◆)
```

Use the ▲ ▼ arrow keys to select the Diff Encoder as **On** or **Off**. Press **ENTER**:



When you select Differential Encoding=OFF, there is no way for the modem to resolve the phase ambiguities associated with PSK modulations. For BPSK there is a 50% chance that the polarity of the data will be correct. In QPSK there is a 25% chance that the data will be correct.

6.2.1.3.5 CONFIG: Tx → Mod (Modulation)

```
Mod=QPSK (B, Q, OQ, 8PSK, 16Q, 8QAM)
FEC Rate=1/2 (1/2, 3/4, 7/8) (◀ ▶ ◆)
```

Use the ◀ ▶ arrow keys to select the **Mod** (modulation type) (top line) or the **FEC Rate** (bottom line). Press **ENTER**. Then, use the ▲ ▼ arrow keys to change that parameter selection. The Encoder type dictates the Modulation Type and FEC rate selections:

Encoder Type	Modulation Type	FEC Rate Choice
No Encoder	BPSK	Fixed at 1/1
	QPSK, OQPSK	Fixed at 1/1
Non-Turbo Encoder	BPSK	Fixed at 1/2
	TCM 8-PSK (FAST option)	Fixed at 2/3
	QPSK, OQPSK	1/2, 3/4, 7/8
	16-QAM (Vit+RS only)	3/4, 7/8
TPC (with TPC/LDPC hardware option installed)	BPSK	5/16, 21/44
	QPSK, OQPSK	1/2 (aka 21/44), 3/4, 7/8, 0.95
	8-PSK (FAST option)	3/4, 7/8, 0.95
	16-QAM (FAST option)	3/4, 7/8
LDPC (with TPC/LDPC hardware option installed)	BPSK	Fixed at 1/2
	QPSK, OQPSK	1/2, 2/3, 3/4
	8-PSK, 8-QAM (FAST)	2/3, 3/4
	16-QAM (FAST option)	Fixed at 3/4
VFEC	BPSK	Fixed at 0.488
	QPSK	0.533, 0.631, 0.706, 0.803
	8-QAM (FAST option)	0.576, 0.642, 0.711, 0.780
	16-QAM (FAST option)	0.644, 0.731, 0.780, 0.829, 0.853
ULL (VersaFEC Ultra-Low Latency)	BPSK	Fixed at 0.493
	QPSK	0.493, 0.654, 0.734

Encoder Type	Modulation Type	FEC Rate Choice
VF2L (VersaFEC-2 Long Block) or VF2S (VersaFEC-2 Short Block)	BPSK	Fixed at 0.489
	QPSK	0.489, 0.537, 0.586, 0.611, 0.635, 0.660, 0.684, 0.733
	8-ARY	0.521, 0.537, 0.562, 0.586, 0.611, 0.635, 0.770, 0.684, 0.708, 0.733
	16-ARY	0.586, 0.611, 0.635, 0.660, 0.684, 0.708, 0.733, 0.757, 0.782
	32-ARY	0.660, 0.684, 0.708, 0.733, 0.757, 0.782, 0.801, 0.831, 0.855, 0.879

When you install the TPC/LDPC hardware option and you select **TPC** from the **CONFIG: Tx > FEC** submenu, the options appear as shown:

```
Mod=QPSK (B,Q OQ,8PSK,16Q,8QAM)
FEC Rate=1/2 (1/2,3/4,7/8,0.95) (< > ◆)
```

When you select **VFEC** from the **CONFIG: Tx > FEC** submenu, the options appear as shown:

```
Mod=BPSK (B,Q,8QAM,16QAM) (< > ◆)
FEC Rate=0.488 (Fixed)
```

When you select **ULL** from the **CONFIG: Tx > FEC** submenu, the options appear as shown:

```
Mod=BPSK (B,Q) (< > ◆)
FEC Rate=0.493 (Fixed)
```

When you select **VF2S** or **VF2L** from the **CONFIG: Tx > FEC** submenu, the options appear as shown:

```
Mod=BPSK (B,Q,8/16/32-ARY) (< > ◆)
FEC Rate=0.489 (Fixed)
```

6.2.1.3.6 CONFIG: Tx → Data

```
Tx Data Rate      Tx Sub-Mux
( ◀ ▶ )
```

Use the ◀▶ arrow keys to select **Tx Data Rate** or **Tx Sub-Mux**. Press **ENTER**.

When **Tx Sub-Mux** is **ON**, this menu provides *read-only* IP Info Rate information on the bottom line:

```
Tx Data Rate      Tx Sub-Mux
(IP Info Rate: 01200.340 kbps)
( ◀ ▶ )
```

CONFIG: Tx → Tx Data → Tx Data Rate

```
Tx Data Rate = 01544.000 kbps
Data Invert=Off  Clock Invert=Off  ( ◀ ▶ ◆ )
```

Use the top line to edit the Tx Data Rate. Use the bottom line to configure the Data Inversion or the Clock Inversion features, which provide compatibility with certain older equipment.

On the top line – Edit the **Tx Data Rate** by using the ◀▶ arrow keys to select the digit to edit, and then using the ▲▼ arrow keys to change that digit. Press **ENTER**.

The range for the Tx Data Rate is from 18 kbps to 25 Mbps. The actual minimum and maximum data rates depend on Framing mode, Interface type, Modulation type and FEC Code Rate. When you change any of the higher-priority parameters – causing the data rate to become invalid – the **Data Rate** adjusts automatically. The installed **FAST option(s)** also dictate the upper range of data rate.

When configuring for D&I or IDR framing or for G.703 interface type, the ▲▼ arrow keys scroll through only the available data rates. When you edit the data rate to 1920 kbps while in D&I framing, a message informs you that E1 Fixed Channel Mode is implemented.

When using G.703, three auxiliary rates are available: 512, 1024 and 2048 kbps. This availability is indicated when the word **AUX** appears to the right of the decimal place (e.g., 00512 . **AUX** kbps).



In Chapter 3. REAR PANEL CONNECTOR PINOUTS – See Sect. 3.3.2.5 G.703 IDI (Insert Data In), DDO (Drop Data Out)

Note that these data rates are *read-only* in QDI (Quad D&I) mode! The data rate is the sum of the tributary rates for all ports.

On the bottom line – You may set either **Data Invert** or **Clock Invert** operation by using the ▲▼ arrow keys to select **On** or **Off**. Press **ENTER**.

CONFIG: Tx → Tx Data → Tx Sub-Mux

```
Tx Sub-Mux = Off (Off, On)
Ratio = 1/9 (IP/Synchronous) (◀ ▶ ⬆)
```

Use the ▲▼ arrow keys to select the desired ratio. Press ENTER. There are a total of 34 ratio selections available:

```
▶ 1/59  ▶ 1/39  ▶ 1/19  ▶ 1/9   ▶ 1/8   ▶ 1/7   ▶ 1/6   ▶ 1/5   ▶ 1/4
▶ 2/7   ▶ 1/3   ▶ 2/5   ▶ 3/7   ▶ 1/2   ▶ 3/5   ▶ 2/3   ▶ 3/4   ▶ 4/5
▶ 1/1   ▶ 5/4   ▶ 4/3   ▶ 3/2   ▶ 5/3   ▶ 2/1   ▶ 7/3   ▶ 5/2   ▶ 3/1
▶ 7/2   ▶ 4/1   ▶ 5/1   ▶ 6/1   ▶ 7/1   ▶ 8/1   ▶ 9/1
```

6.2.1.3.7 CONFIG: Tx → Symb (IP-ACM or V2-ACM Modes Only)



Appendix M. ADAPTIVE CODING AND MODULATION (ACM)



VersaFEC ACM or VerseFEC-2 ACM modes require the appropriate FAST codes for the maximum operating symbol rate.

```
TxSymbolRate = 01000.000 kbps (ACM Mode)
Data Invert=Off Clock Invert=Off (◀ ▶ ⬆)
```

It is important that you understand that the use of **IP-ACM** or **V2-ACM** modes represent fundamental departures from the way you would typically configure the modem. When either ACM mode is active, the **CONFIG: Tx** menu changes the **Data** option to **Symb**.

Use the ◀▶ arrow keys to select **TxSymbolRate**, **Data Invert**, or **Clock Invert**. Press ENTER.

On the top line – Edit the Tx Symbol Rate by using the ◀▶ arrow keys to select the digit to edit. Then, use the ▲▼ arrow keys to change that digit. Press ENTER.

On the bottom line – Set the **Data Invert** or **Clock Invert** operations by using the ▲▼ arrow keys to select either as **On** or **Off**. Press ENTER.

6.2.1.3.8 CONFIG: Tx → Scrambler

```
Tx Scrambler = IESS (Normal, IESS, Off)
IESS-315 v.35 Scrambler (⬆)
```

Use the ▲▼ arrow keys to select **Normal**, **IESS**, or **Off**. Press ENTER.

The modem automatically selects the actual scrambler used for **Normal**, depending on the exact operating mode:

- If framing = IBS/D&I, the IESS-309 scrambler is used.
- If Reed-Solomon is on but IBS/D&I is off, its frame synchronous scrambler is used per IESS-310, App. H. An exception to this is legacy EF Data Reed-Solomon, which uses a proprietary modified V.35 scrambler instead.
- If framing = EDMAC/2/3 and Reed-Solomon is **OFF**, its frame synchronous scrambler is used.
- If configured for TPC (Turbo) encoding and all of the above settings are off, the TPC frame scrambler is used except for 8-QAM. For CDM-570 compatibility, TPC with 8-QAM uses the V.35 scrambler.
- ITU V.35 scrambler (Intelsat variant) is the default scrambler when all of the above settings are **OFF**.

When you select **IESS**, the default ITU V.35 scrambler specified in IESS-315 takes priority over all “normal” scramblers and is used instead. Therefore, for many operating modes, the two scrambler selections are redundant.

When using TPC and Carrier-in-Carrier simultaneously, the IESS-315 (V.35) scrambler is the only permitted choice.

6.2.1.4 CONFIG: Rx

```
RxIF Freq FEC Demod Data Descram Eq EbNo
(Data 02048.000kbps,02184.533ksps) ( ◀ ▶ ⬢ )
```

On the top line – Use the ◀▶ arrow keys to select a parameter. Press ENTER.

On the bottom line – *Read-only* Data/Symbol rate information is provided.



- 1) When CONFIG: Mode = IP-ACM or V2-ACM, EbNo on the top line of this display is replaced by SNR.
- 2) When Sub-Mux is ON, the Data Rate information on the bottom line of this display is replaced by Composite Rate information.

6.2.1.4.1 CONFIG: Rx → Rx-IF

```
Rx: Acquisition Sweep Range = +/- 032 kHz
SpectrumInvert=Off Rxα=.35 (.35, .12) ( ◀ ▶ ⬢ )
```

Use the ◀▶ arrow keys to select a parameter. Press ENTER.

- **Acquisition Sweep Range** – The **Acquisition Sweep Range** value determines the amount of frequency uncertainty the demodulator will sweep over in order to find and lock to an incoming carrier. When operating at low bit rates, large values of sweep range (compared to the data rate) cause excessively long acquisition times.

For example, when you select ± 32 kHz with a data rate of 2.4 kbps, BPSK will result in an average acquisition time of around 3 minutes.

The Rx symbol rate determines the Sweep Range limits:

Rx Symbol Rate	Sweep Range Limit
± 1 to symbol rate / 2 (ksps)	18-64 kbps
± 1 to 32 kHz	64-389 ksps
± 1 to (10% of symbol rate)	389-3000 ksps
± 1 to 300 kHz	>3000 ksps

Use the ▲▼ arrow keys to edit the setting in 10 kHz increments. Press ENTER.

- **Spectrum Invert** – Use the ▲▼ arrow keys to set **Spectrum Invert** as **Off** or **On**. Press ENTER.



SPECTRUM INVERT should normally be in the OFF position. Rx spectrum is inverted in the ON position (which is the same as reversing the direction of phase rotation in the demodulator). When in BPSK mode, note that the

demodulator automatically synchronizes to either the normal time-ordering of bits FEC codeword pairs, or the inverted ordering used by certain other manufacturers.

- **Rx α (Rx Alpha Filter Rolloff Factor)** – Use the **▲▼** arrow keys to select the **Tx α** . Press **ENTER**. Valid settings are:

Rx α (Rx Alpha rollout Factor) (%)	Default
0.12	0.35



- Select **Rx α = 0.35** if the **Tx α** of the signal being received is **0.25** or **0.35**.
- Select **Rx α = 0.12** if the **Tx α** of the signal being received is **0.20**, **0.15**, **0.10**, or **0.05**.

6.2.1.4.2 CONFIG: Rx → Freq (Frequency)

Rx-IF Frequency: 0050.0000 MHz (◀ ▶ ⬆)

Edit the Rx-IF Frequency by using the **◀▶** arrow keys to select a digit, and then using the **▲▼** arrow keys to change that digit. Press **ENTER**. Valid settings are:

IF Frequency	Range	Step Size (Increment)
70/140 MHz	50-180 MHz	100 Hz
L-Band (FAST Option)	950-2250 MHz	100 Hz

When you use the ODU menus to configure an LNB lockout frequency, this screen displays a second line of information (this example uses low-sided mix):

Rx-IF Frequency: 1200.0000 MHz
(LO:12500 MHz Sat:13700.0000 MHz) (◀ ▶ ⬆)

The Satellite frequency updates accordingly as you edit the IF frequency.



Satellite frequency = LO ± IF frequency, where the sign is determined by the LO mix parameter:

- **High-sided mix [-] (includes a spectral inversion);**
- **Low-sided mix [+].**

6.2.1.4.3 CONFIG: Rx → FEC

```
Dec=Vit (Vit,Seq,TCM,TPC,LDPC,VFEC,ULL)
Reed-Solomon=Off (Off,On) (◀▶◆)
```

Use the ◀▶ arrow keys to select **Dec** (Decoder) or **Reed-Solomon** (or **Diff Encoder** – see **Note 1** below). Press **ENTER**.

On the top line – Use the ▲▼ arrow keys to select an available Decoder option (shown in parentheses). Press **ENTER**. Valid selections are:

- | | | |
|---|--|--|
| ▶ None (i.e., uncoded) | ▶ Vit (Viterbi) | ▶ Seq (Sequential) |
| ▶ TCM (Trellis Coded Modulation)
8-PSK Rate 2/3 only (FAST option) | ▶ TPC (Turbo Product Codec)
(Hardware option) | ▶ LDPC (Low Density Parity
Check) (Hardware option) |
| ▶ VFEC (VersaFEC) | ▶ VF2L (VersaFEC-2 Long Block) | ▶ VF2S (VersaFEC-2 Short Block) |
| ▶ ULL (VersaFEC Ultra-Low Latency) | | |



- 1) When you select **None** as the Encoder setting, the bottom line of the display changes from **Reed-Solomon** to **Diff Encoder** (Differential Encoding).
- 2) The **TPC** (Turbo) and **LDPC** encoding selections appear only when you install the **TPC/LDPC hardware option**.

On the bottom line – When **Reed-Solomon** is present, use the ▲▼ arrow keys to select it as **On** or **Off**. Press **ENTER** to continue.

CONFIG: Rx → FEC → Reed-Solomon On

```
Reed-Solomon Decoding =IESS-310 (219/201)
(Standard (126/110), IESS-310 (219/201)) (◆)
```

Use the ▲▼ arrow keys to select an available parameter. Press **ENTER**. Depending on the Framing mode, valid selections are:

- ▶ **IESS-310, open or closed network** 219/201
- ▶ **IBS or D&I** 126/112
- ▶ **EDMAC or EDMAC2, closed network** 200/180
- ▶ **IDR, open network** 225/205, 219/201 or 194/178
- ▶ **ESC++ or D&I++, closed network** 126/112
- ▶ **Unframed closed network:**
 - **Comtech standard** 220/200
 - **Legacy EF Data** 225/205, with V.35 scrambling

Otherwise, when **Diff Encoder** is present, use the ▲▼ arrow keys to select it as **On** or **Off**. Press **ENTER** to continue.

CONFIG: Rx → FEC → Diff Encoder On



When you select Differential Decoding as OFF, there is no way for the modem to resolve the phase ambiguities associated with PSK modulations. For BPSK there is a 50% chance that the polarity of the data will be correct. In QPSK there is a 25% chance that the data will be correct.

```
Enc=None (None, Vit, Seq, TCM, TPC, LDPC, VFEC)
Diff Encoder=On (Off, On) (◀ ▶ ◆)
```

6.2.1.4.4 CONFIG: Rx → Demod (Demodulation)

```
Demod=QPSK (B, Q, OQ, 8PSK, 16QAM)
FEC Rate=1/2 (1/2, 3/4, 7/8) (◀ ▶ ◆)
```

Use the ◀▶ arrow keys to select **Demod** (top line) or **FEC Rate** (bottom line). Press **ENTER**. Then, for either, use the ▲▼ arrow keys to select the setting. The Decoder type selected dictates the FEC Rate selections:

Decoder Type	Modulation Type	FEC Rate Choice
No Encoder	BPSK	Fixed at 1/1
	QPSK, OQPSK	Fixed at 1/1
Non-Turbo Encoder	BPSK	Fixed at 1/2
	TCM 8-PSK (FAST option)	Fixed at 2/3
	QPSK, OQPSK	1/2, 3/4, 7/8
	16-QAM (Vit+RS only)	3/4, 7/8
TPC (with TPC/LDPC hardware option installed)	BPSK	5/16, 21/44
	QPSK, OQPSK	1/2 (aka 21/44), 3/4, 7/8, 0.95
	8-PSK (FAST option)	3/4, 7/8, 0.95
	16-QAM (FAST option)	3/4, 7/8
LDPC (with TPC/LDPC hardware option installed)	BPSK	Fixed at 1/2
	QPSK, OQPSK	1/2, 2/3, 3/4
	8-PSK, 8-QAM (FAST)	2/3, 3/4
	16-QAM (FAST option)	Fixed at 3/4
VFEC	BPSK	Fixed at 0.488
	QPSK	0.533, 0.631, 0.706, 0.803
	8-QAM (FAST option)	0.576, 0.642, 0.711, 0.780
	16-QAM (FAST option)	0.644, 0.731, 0.780, 0.829, 0.853
ULL (VersaFEC Ultra-Low Latency)	BPSK	Fixed at 0.493
	QPSK	0.493, 0.654, 0.734
VF2L (VersaFEC-2 Long Block) or VF2S (VersaFEC-2 Short Block)	BPSK	Fixed at 0.489
	QPSK	0.489, 0.537, 0.586, 0.611, 0.635, 0.660, 0.684, 0.733

Decoder Type	Modulation Type	FEC Rate Choice
VF2L or VF2S (cont.)	8-ARY	0.521, 0.537, 0.562, 0.586, 0.611, 0.635, 0.770, 0.684, 0.708, 0.733
	16-ARY	0.586, 0.611, 0.635, 0.660, 0.684, 0.708, 0.733, 0.757, 0.782
	32-ARY	0.660, 0.684, 0.708, 0.733, 0.757, 0.782, 0.801, 0.831, 0.855, 0.879

When you install the TPC/LDPC hardware option and are able to select **TPC** from the **CONFIG: Rx > FEC** submenu, the options appear as shown:

```
Demod=QPSK (B,Q OQ, 8PSK, 16Q, 8QAM)
FEC Rate=1/2 (1/2, 3/4, 7/8) (◀ ▶ ⬆)
```

When you select **VFEC** from the **CONFIG: Rx > FEC** submenu, the options appear as shown:

```
Demod=BPSK (B,Q, 8QAM, 16QAM) (◀ ▶ ⬆)
FEC Rate=0.488 (Fixed)
```

When you select **ULL** from the **CONFIG: Rx > FEC** submenu, the options appear as shown:

```
Demod=BPSK (B,Q) (◀ ▶ ⬆)
FEC Rate=0.493 (Fixed)
```

6.2.1.4.5 CONFIG: Rx → Data

```
Rx Data Rate Rx Sub-Mux (◀ ▶)
```

Use the ◀▶ arrow keys to select **Rx Data Rate** or **Rx Sub-Mux**. Press **ENTER**.

If **Rx Sub-Mux** is **ON**, this menu provides *read-only IP Info Rate* information on the bottom line, as shown:

```
Rx Data Rate Rx Sub-Mux
(IP Info Rate: 01200.340 kbps) (◀ ▶)
```

CONFIG: Rx → Data → Rx Data Rate

```
Rx Data Rate = 01544.000 kbps
Data Invert=Off Clock Invert=Off (◀ ▶ ⬆)
```

Use the top line to edit the **Rx Data Rate**. The bottom line permits selection of the Data Inversion or the Clock Inversion features (added for compatibility with certain older equipment).

On the top line – Edit the **Rx Data Rate** by using the ◀▶ arrow keys to select a digit, and then using the ▲▼ arrow keys to change that digit. Press **ENTER**.

The maximum limits for the Rx Data Rate are 18kbps to 25Mbps. The actual minimum and maximum data rates are dependent on Framing mode, Interface type, Modulation type and FEC Code Rate. When you change any of the higher-priority parameters – causing the data rate to become invalid – the **Data Rate** adjusts automatically. The installed **FAST option(s)** also dictate the upper range of data rate.

When configuring for D&I or IDR framing or for G.703 interface type, the ▲▼ arrow keys scroll through only the available data rates. When you edit the data rate to 1920 kbps while in D&I framing, a message appears to indicate that E1 Fixed Channel Mode is implemented.

When G.703 is used, three auxiliary rates – 512, 1024, and 2048 kbps – are available as indicated by the word **AUX** appearing to the right of the decimal place (**for example, 00512 .AUX kbps**).



AUX G.703 Data Rate Connectors Reference: Sect. 3.3.2.5 G.703 IDI (Insert Data In), DDO (Drop Data Out) Connectors in Chapter 3. REAR PANEL CONNECTORS AND PINOUTS.

Note that, in QDI (Quad D&I) mode, these data rates are **read-only** and data input is fixed at **OFF**. The data rate is the sum of the tributary rates for all ports.

On the bottom line – Set the **Data Invert** or **Clock Invert** operation as **On** or **Off** by using the ▲▼ arrow keys. Press **ENTER**.

CONFIG: Rx → Rx Data → Rx Sub-Mux

Rx Sub-Mux = Off (Off, On)
Ratio = 1/9 (IP/Synchronous) (◀ ▶ ◆)

Use the ▲▼ arrow keys to select the desired ratio. Press **ENTER**. Valid selections are:

▶ 1/59	▶ 1/39	▶ 1/19	▶ 1/9	▶ 1/8	▶ 1/7	▶ 1/6	▶ 1/5	▶ 1/4
▶ 2/7	▶ 1/3	▶ 2/5	▶ 3/7	▶ 1/2	▶ 3/5	▶ 2/3	▶ 3/4	▶ 4/5
▶ 1/1	▶ 5/4	▶ 4/3	▶ 3/2	▶ 5/3	▶ 2/1	▶ 7/3	▶ 5/2	▶ 3/1
▶ 7/2	▶ 4/1	▶ 5/1	▶ 6/1	▶ 7/1	▶ 8/1	▶ 9/1		

6.2.1.4.6 CONFIG: Rx → Symb (IP-ACM or V2-ACM Modes Only)



Appendix M. ADAPTIVE CODING AND MODULATION (ACM)



VersaFEC ACM or VersaFEC-2 ACM modes require the appropriate FAST codes for the maximum operating symbol rate.

```
RxSymbolRate = 01000.000 ksps (ACM Mode)
Data Invert=Off Clock Invert=Off (◀ ▶ ⚡)
```

When either ACM mode is active, the **CONFIG: Rx** menu changes the **Data** option to **Symb**.

On the top line – Edit the **Rx Symbol Rate** by using the ◀▶ arrow keys to select a digit, and then using the ▲▼ arrow keys to change that digit. Press **ENTER**. Note that asymmetric operation is supported – transmit and receive symbol rates do not have to be equal.

On the bottom line – Set the **Data Invert** or **Clock Invert** operation by using the ▲▼ arrow keys to select **On** or **Off**. Press **ENTER**.

6.2.1.4.7 CONFIG: Rx → Descram (Descrambler)

```
Rx Descrambler = IESS (Normal, IESS, Off)
IESS-315 V.35 Scrambler (⚡)
```

Use the ▲▼ arrow keys to select **Normal**, **IESS**, or **Off**. Press **ENTER**.

The modem automatically selects the actual scrambler used for **Normal**, depending on the exact operating mode:

- When framing = IBS/D&I, the IESS-309 scrambler is used.
- When Reed-Solomon is **ON** but IBS/D&I is **OFF**, its frame synchronous scrambler is used per IESS-310, App. H. An exception to this is legacy Comtech EF Data Reed-Solomon, which instead uses a proprietary modified V.35 scrambler.
- When framing = EDMAC/2/3 and Reed-Solomon is **OFF**, its frame synchronous scrambler is used.
- When configured for TPC (Turbo) encoding and all of the above settings are **OFF**, the TPC frame scrambler is used except for 8-QAM. For CDM-570 compatibility, TPC with 8-QAM uses the V.35 scrambler.
- ITU V.35 scrambler (Intelsat variant) is the default scrambler when all of the above settings are **OFF**.

When you select **IESS**, the default ITU V.35 scrambler specified in IESS-315 takes priority over all “normal” scramblers and is used instead. Therefore, for many operating modes, the two scrambler selections are redundant.

When using TPC and Carrier-in-Carrier simultaneously, the IESS-315 (V.35) scrambler is the only permitted choice.

6.2.1.4.8 CONFIG: Rx → Eq (Equalizer)

```
Rx Equalizer:
      Disabled  (Enable,Disable)  (◄)
```

Use the ▲▼ arrow keys to select **Enable** or **Disable**. Press **ENTER**. The integrated 5-tap adaptive equalizer can compensate for:

- Amplitude slope and variation over the symbol bandwidth.
- Non-linear group delay variation over the symbol bandwidth.

The Rx Equalizer is particularly useful at higher symbol rates (up to 12.5 Msymbols/second) in situations with long cable runs between equipment (downconverter and modem, for example).

The Eb/No estimate is performed after the adaptive equalizer block, which provides an easy way to determine if the equalizer is providing any benefit. If the equalizer is first turned off, the Eb/No may be viewed on the monitor screen. The equalizer is then turned on, and the Eb/No viewed on the monitor screen to determine any improvement.

6.2.1.4.9 CONFIG: Rx → EbNo

```
Receive EbNo Alarm Point = 02.0 dB
                                     (◀ ▶ ◄)
```

Edit the EbNo Alarm Point by using the ◀▶ arrow keys to select a digit, and then using the ▲▼ arrow keys to change that digit. The allowable range is from 00.1 to 16.0 dB. Press **ENTER**.



If the Rx Eb/No falls below this value and the fault is NOT masked, a receive traffic fault will be generated.

6.2.1.4.10 CONFIG: Rx → SNR (IP-ACM or V2-ACM Modes Only)

```
Receive SNR Alarm Point = 00.1 dB
                                     (◀ ▶ ◄)
```

When either ACM mode is active, the **CONFIG: Rx** menu changes the **EbNo** option to **SNR**.

Edit the SNR Alarm Point by using the ◀▶ arrow keys to select a digit, and then using the ▲▼ arrow keys to change that digit. The allowable range is from 00.1 to 16.0 dB. Press **ENTER**.



If the Rx SNR falls below this value and the fault is NOT masked, a receive traffic fault will be generated.

6.2.1.5 CONFIG: Clocks

```

Clocking:  TxClock    RxBuffer/Clock
Clock-Ext  Freq-Ref   Int-Ref-Adjust (◀ ▶)
    
```

Use the ◀▶ arrow keys to select a parameter. Press **ENTER**.

6.2.1.5.1 CONFIG: Clocks → Tx Clock

```

Transmit Clock = Internal (SCT)
(Int (SCT), TxTerr (TT), RxLoop, ETTSTRxS) (▲ ▼)
    
```

Use the ▲▼ arrow keys to select from the options shown in parentheses. Press **ENTER**.

Note that:

Setting	Function
Internal (SCT)	This is the required setting when the Tx interface type is Audio. Indicates that the unit will supply a clock to the DTE, which is derived from its internal high-stability source.
Tx-Terrestrial (TT)	This is the required setting when the modem's interface type is G.703. Indicates that the unit expects to receive a clock from the DTE, to which the unit can phase-lock its internal circuits. If no clock is detected the modem will substitute its internal clock and generate an alarm.
Rx-Loop-timed	Allows the modem's internal clock to be phase locked to the Rx buffer clock source. This output clock is Send Timing. Choosing Rx-Loop does not automatically select Rx-Sat as the buffer clock source. This allows for increased flexibility for modem clock selection. While you typically should select Rx-Sat, other selections are also available. Example: You have an available high stability 10 MHz clock source, but the end equipment only accepts a clock at the information data rate. Selecting Tx Clock = Rx-Loop and Rx Buffer Clock = EXT-REF provides receive timing and send timing to the end equipment that is sourced from the 10 MHz reference.
Ext-TT (ST = Rx Sat)	Only valid if: RS422, V.35, HSSI or LVDS, Tx and Rx data rates are equal, no RS, and no framing. This mode is available to permit a particular variation of Loop Timing. In this mode, transmit timing is taken from the TT pins, but ST is active and gives out a copy of the Rx Satellite Clock.



Appendix E. CLOCK MODES AND DROP & INSERT (D&I).

6.2.1.5.2 CONFIG: Clocks → Rx Buffer/Clock

```
Clk=Rx-Sat (Rx-Sat, TxTerr, Int (SCT), Ins)
Buffer-Size = 00016bytes (00002ms) CENTER
```

Use the ◀▶ arrow keys to set the **Rx Clock** (top line) or the **Buffer-Size** (bottom line).

On the top line – To set the **Rx Clock**, use the ▲▼ arrow keys to select a parameter. Press **ENTER**. Valid settings are:

Setting	Function
Rx-Sat	Sets the Receive buffer clock source to the satellite clock (the receive buffer is bypassed). Note: This will fix the buffer size to minimum.
Tx-Terr	In this timing mode, data is clocked out of the receive buffer using the external transmit clock.
Int(SCT)	Data is clocked out of the buffer using the same reference that drives the modem Internal(SCT).
Ins(ert)	Available only if Rx framing is D&I and Rx interface is G.703. Sets the buffer clock to the Insert stream.

On the bottom line – To set the **Buffer-Size**, use the ◀▶ arrow keys to select a digit, and then use the ▲▼ arrow keys to change that digit. Press **ENTER**.



Buffer Size indicates the size in bytes (and size in milliseconds) of the Plesiochronous / Doppler Buffer. The minimum buffer size and step size (increment) are usually the same, and are dictated by the following rules:

If Framing is D&I or D&I++:

If D&I Type is:	Step size (bytes)
E1 D&I @ 1920kbps	1024
T1-D4	24 x n or 3ms
T1-ESF	48 x n or 6ms
E1	32 x n or 4ms

Otherwise:

If data rate is:	Step size (bytes)
1544 kbps (T1)	1158
2048 kbps (E1)	1024
6312 kbps (T2)	1578
8448 kbps (E2)	528
Otherwise	2, with minimum size of 16 bytes

CONFIG: Clocks → Rx Buffer/Clock → CENTER

Selecting **CENTER** displays the following screen:

```
Press ENTER to CENTER the Buffer
otherwise, Press CLEAR
```

Press **ENTER** or **CLEAR** to return to the previous menu.

6.2.1.5.3 CONFIG: Clocks → Clk-Ext (G.703 Clock Extension)



Appendix E. CLOCK MODES AND DROP & INSERT (D&I).

```
G.703 Clock Extension:
      Mode      Interface      ( ◀ ▶ )
```

Use the ◀▶ arrow keys to select **Mode** or **Interface**. Press **ENTER**.

CONFIG: Clocks → Clk-Ext → Mode

```
G.703 Clock Extension Mode: RxEnable
      (None, TxLock, RxEnable)      ( ⬆ )
```

Use the ▲▼ arrow keys to select a parameter. Press **ENTER**. Valid settings are:

Setting	Function
None	All G.703 Clock extension modes are disabled.
TxLock	The CDM-625A (operating in a non-G.703 mode) locks its transmit clock timing to an externally presented G.703 reference signal.
RxEnable	The CDM-625A (operating in a non-G.703 mode) synthesizes a G.703 timing reference from the Rx satellite signal, regardless of its actual data rate.

CONFIG: Clocks → Clk-Ext → Interface

```
G.703 Clock Extension:
      Interface: T1      (T1, E1-B, E1-U)      ( ⬆ )
```

When you select **TxLock** as the mode, the transmit timing of the CDM-625A *locks* to the timing presented of the interface type selected here.

When you select **RxEnable** as the mode, the CDM-625A *generates* a timing signal of the interface type selected here.



The two interface types do not need to be the same for a particular link. For example, if it is required to generate an E1 reference signal at the remote site, but at the local end only a T1 reference signal is available, this is supported.

6.2.1.5.4 CONFIG: Clocks → Freq-Ref

```
Frequency Reference: Internal
(Internal (with O/P) , 1, 2, 5, 10MHz) (◄)
```

Use the ▲▼ arrow keys to select one of the two internal reference modes – **Internal** and **Internal (with Output)** – and then press **ENTER**.

Internal (with Output) mode uses the internal reference as an output on the rear panel **Ext Ref In/Out** BNC connector. This mode is useful if a user wishes to use a single frequency reference for both the modem and another piece of equipment in the system. When you select this mode, an amber LED adjacent to the connector illuminates to alert you that the connector, normally used as input, now has an output signal present.

6.2.1.5.5 CONFIG: Clocks → Int-Ref-Adjust

```
Internal Hi-Stability 10MHz Reference
Fine Adjust: +048 (+/-999) (◀ ▶ ◄)
```

Use this menu for very fine adjustment of the Internal 10MHz Reference. When you select the Internal 10 MHz Reference, the adjustment value is retained in EEPROM memory, and is therefore not lost when the NVRAM memory is cleared.

Use the ◀▶ arrow keys to select a digit, and then use the ▲▼ arrow keys to change that digit. Press **ENTER**.



Changes made to the adjust value occur immediately upon entry, not after Pressing the ENTER key.

6.2.1.6 CONFIG: D&I (Drop & Insert)



- Sect. 6.2.1.2 CONFIG: Mode
- Appendix E. CLOCK MODES AND DROP & INSERT (D&I).



- 1) Drop & Insert operation is a FAST option.
- 2) D&I (Drop & Insert) is not available when you select either ACM mode.

If you do not select D&I or D&I++ as the framing mode, the D&I menu branch displays as follows:

```
Drp-Type= N/A      Chan/TS      Loop=Y (Y/N)
Ins-Type= N/A      Chan/TS      ( ◀ ▶ ⚡ )
```

6.2.1.6.1 CONFIG: D&I (D&I, D&I++ One-Port Drop and Insert Framing Mode)

With D&I or D&I++ set as the framing mode, the D&I menu branch displays One-Port D&I operation as follows:

```
Drp-Type= T1-D4    Chan/TS      Loop=Y (Y/N)
Ins-Type= T1-D4    Chan/TS      ( ◀ ▶ ⚡ )
```

On the top line – Use the ◀▶ arrow keys to select the **Drp-Type** (Drop-Type); its **Chan/TS** (Channel Timeslot); or the **Loop**.

On the bottom line – Select the **Ins-Type** (Insert-Type) or its **Chan/TS** (Channel Timeslot).

For any of these selections, press **ENTER** to continue on to that selection's nested menu, and then use the ▲▼ arrow keys to individually edit those parameters.



When you select Quad Drop and Insert (QDI) or Framed QDI as the framing mode, the D&I menu branch appears as follows:

```
Quad D&I (QDI):    (E1's are synchronous)
Drop  Insert Sync/Async Clock Mode ( ◀ ▶ )
```

See Sect. 6.2.1.6.2 for instructions on using the QDI version of the CONFIG: D&I menu branch.

CONFIG: D&I → Drp-Type or Ins-Type



Appendix E.6 Frame Formats

The available Frame Format types for Drop or Insert are:

Frame Format (Type)	Description
T1-D4	T1 D4 Framing
T1-ESF	T1 Extended Super Frame Framing
E1-CCS	E1 Common Channel Signaling Framing
E1-CAS	R1 Channel Associated Signaling Framing

Use the ▲▼ arrow keys to select the desired Drop-Type or Insert-Type. Press **ENTER**.

CONFIG: D&I → (Drop or Insert) Chan/TS (Channel Timeslots)

```
Drp-Ch:  1
        TS: 01
```

```
Ins-Ch:  1
        TS: 01
```

Use the ▲▼ arrow keys to select the number of Drop or Insert Channel Timeslots, from **na** to **24**. Press **ENTER**.

The number of available Channel Timeslots depends on the data rate:

- If the data rate is 1920 kbps and the framing is D&I, then only the E1 formats are available and the **Chan/TS** menus are disabled. This is the 'Fixed Channel Mode' where all timeslots are allocated in order. D&I++ does not have 'Fixed Channel Mode'.
- If the framing is D&I and Drop/Insert Type is E1-CAS, Timeslot 16 is used solely for CAS signaling and therefore may not be allocated for traffic data.

CONFIG: D&I → Loop

Select **Loop** to tie **Drop Data Out (DDO)** to **Insert Data Input (IDI)** without having to externally connect cables to these ports. Use the ▲▼ arrow keys to select **Y(es)** or **N(o)** for the **Loop** feature.

6.2.1.6.2 CONFIG: Quad D&I (QDI) (QDI, Framed QDI Framing Mode)

With QDI or Framed QDI set as the framing mode, the D&I menu branch displays Quad D&I operation as follows:

```
Quad D&I (QDI):      (EIs are synchronous)
Drop   Insert   Sync/Asynch Clock Mode (◀ ▶)
```

Use the ◀▶ arrow keys to select **Drop**, **Insert**, or **Sync/Asynch Clock Mode**. Press **ENTER**.

CONFIG: Quad D&I (QDI) → Drop or Insert

```
QDI Port[ch]: Drop:      01536 kbps
 1[09] 2[15] 3[00] 4[00] (◀ ▶◆)
```

```
QDI Port[ch]: Insert:    01536 kbps
 1[09] 2[15] 3[00] 4[00] (◀ ▶◆)
```

The **Drop** or **Insert** submenus show information for all four ports of the Drop or Insert sides, and the cumulative Tx or Rx data rates.

Typical for either submenu, you may allocate no less than one channel and no more than 32 channels for each port. Use the ◀▶ arrow keys on the bottom line to select the port to edit, and then use the ▲▼ arrow keys to edit the number of channels for that port. The cumulative data rate calculates and displays on the top line as you edit the number of channels. Press **ENTER**.

Note that:

- If you select **32** channels for the active port, that port's operation is fixed to, and the nested timeslot menu instead reads, "**Fixed channel mode**" where all timeslots are allocated in order. Press **ENTER** or **CLEAR** to return to the previous menu.
- If you select **00** channels for the active port, the nested timeslot menu displays but is **disabled**. Press **ENTER** or **CLEAR** to return to the previous menu.

Otherwise, for a port where the channel is set from **01** to **31**, the nested menu appears as follows (where **Port#X** denotes the tributary port **Port#1** through **Port#4**):

```
QDI Drp-Ch:  1  2  3  4  5  6  7  8  >
Port#X TS: 01 02 03 04 11 12 13 14
```

```
QDI Ins-Ch: 24 25 26 27 28 29 30 31
Port#X TS: 07 17 04 23 05 14 10 08
```

Each display is limited to eight channels. The '>' character displays at the top line, right-hand side of the Drop or Insert screen to indicate that there are channels beyond Channel 8 available for selection, up to Channel **31** (as shown by the preceding examples). Use the ◀▶ arrow keys as necessary to scroll between these nested selections.

Once you select a channel, use the ▲▼ arrow keys on the bottom line to select a timeslot value, from **na** to **31**, for that channel. Press **ENTER**.

CONFIG: Quad D&I (QDI) → Sync/Asynch Clock Mode

```
E1 Clock Sync/Asynch Mode:
Synchronous (Sync/Asynch) (◄)
```

Use the ▲▼ arrow keys to select the operation as **Synchronous** or **Asynchronous**. Press **ENTER**.

6.2.1.7 CONFIG: ACM (Adaptive Coding and Modulation) (IP-ACM or V2-ACM Modes Only)



Appendix M. ADAPTIVE CODING AND MODULATION (ACM)

```
ACM Config: Min/Max-ModCod Unlock-Action  
Target-SNR-Margin (◀ ▶)
```

Use the ◀▶ arrow keys to select a parameter. Press ENTER.

6.2.1.7.1 CONFIG: ACM → Min/Max-ModCod

```
Min Modcod: 00 (B 0.488 0.488 bps/Hz)  
Max Modcod: 00 (B 0.488 0.488 bps/Hz)
```

Use the ◀▶ arrow keys to select the top line to set your Min(imum), or bottom line for your Max(imum), ModCod settings. For either setting, depending on your active ACM mode, use the ▲▼ arrow keys to define the range of ModCods over which the system will operate:

If using IP-ACM Mode:

- ModCod **00** is BPSK Rate 0.488 (0.49 bps/Hz);
- ModCod **11** is 16-QAM Rate 0.853 (3.41bps/Hz).

If using V2-ACM Mode:

- The *minimum* setting for **VF2S** (Short Block VersaFEC-2) and **VF2L** (Long Block VersaFEC-2) is **fixed** at ModCod **00** (BPSK Rate 0.489 (0.49 bps/Hz)).
- For **VF2S**, the *maximum* selectable ModCod **35** is 32-ARY Rate 0.831 (4.153 bps/Hz).
- For **VF2L**, the *maximum* selectable ModCod **37** is 32-ARY Rate 0.879 (4.397 bps/Hz).

Press ENTER.



If you wish to constrain the system to run at a fixed ModCod, set the Min and Max ModCod values to be equal.

The value of Max ModCod may be limited by other FAST codes installed. For example, suppose the 4100 kbps FAST option is activated and the symbol rate set to 4100 kbps, the theoretical maximum data rate would be 14 Mbps at ModCod 11. However, if CnC is being used, with a 10 Mbps FAST limit the ACM Max ModCod will be limited to ModCod 7, or 9.6 Mbps.

6.2.1.7.2 CONFIG: ACM → Unlock-Action

If using IP-ACM Mode:

```
When distant-end demod loses lock:  
Go to min Tx ModCod (Maintain,Min) (↕)
```

Use this submenu to establish the desired action when the remote demod loses lock. **This is important**, as the ACM system depends on the feedback of the SNR metric from the remote demod to determine the optimum ModCod. Use the ▲▼ arrow keys to select **Go to min Tx ModCod** (*recommended*) or **Maintain Tx ModCod**. Press ENTER.

If using V2-ACM Mode:

```
When distant-end demod loses lock:  
Go to Tx ModCod 0 (Fixed in VEFC-2)
```

This screen is *read-only*. Press ENTER or CLEAR to return to the previous menu.

6.2.1.7.3 CONFIG: ACM → Target-SNR-Margin

```
Target SNR Margin = 1.0 dB (0.0 - 4.5)  
                    (↕)
```

Use the ▲▼ arrow keys to select a margin value from **0.0** to **4.5** dB, in 0.5 dB increments. Press ENTER.



The ACM system is designed to switch based on thresholds that correspond to a BER of 5×10^{-8} for each ModCod. However, in order to prevent oscillation around two ModCods at this exact value, 0.3 dB of hysteresis has been added.

6.2.1.8 CONFIG: CnC



CnC operation requires that you purchase one of several available FAST options to provide capability to a maximum of 25Mbps.

- 1) **Appendix F. DoubleTalk Carrier-in-Carrier OPTION**
- 2) **For more information about purchasing FAST options:**
 - Sect. 6.2.8 SELECT: FAST menus
 - Sect. 1.3.10 Fully Accessible System Topology (FAST)
 - Chapter 5. FAST ACTIVATION PROCEDURE

```
Carrier in Carrier:  Mode      Freq-Offset
Search-Delay       PMSI-control    ( ◀ ▶ )
```

Use the ◀▶ arrow keys to select a parameter. Press ENTER.

6.2.1.8.1 CONFIG: CnC → Mode



See Sect. F.6 Carrier-in-Carrier Automatic Power Control (CnC-APC) for complete details about, and setup of, the CnC-APC feature.

```
CnC Mode: APC,Side-A,C-band (Off, On, APC)
Activate? N(Y,N) APC is not active ( ◀ ▶ ⬆ )
```

On the top line – Use the ▲▼ arrow keys to select the appropriate CnC operating mode. Valid selections are:

- Off
- On (normal)
- APC,Side A,C-band
- APC,Side A,X-band
- APC,Side A,Ku-band
- APC,Side A,Ka-band
- APC,Side B,C-band
- APC,Side B,X-band
- APC,Side B,Ku-band
- APC,Side B,Ka-band

6.2.1.8.2 CONFIG: CnC → CONFIG: CnC → Freq-Offset

```
CnC Frequency Offset:      (range 1-032)
                          +/-015 kHz    ( ◀ ▶ ⬆ )
```

Use this menu to set the maximum expected frequency offset between the outbound interferer and the desired inbound. It normally corresponds to the demod acquisition range.

Use the ▲▼ arrow keys to edit the CnC Frequency Offset value. Press ENTER. The upper limit of Frequency Offset is determined by the Rx symbol rate:

- **Below 64 ksymbols/sec:** ± 1 to $\pm(Rs/2)$ kHz, where:
$$Rs = \text{symbol rate in ksymbols/sec}$$
- **Between 64 and 389 ksymbols/sec:** ± 1 up to a maximum of ± 32 kHz
- **Above 389 ksymbols/sec:** ± 1 to $\pm (0.1Rs)$ kHz, up to a maximum of ± 200 kHz

This range is pre-calculated and displayed in parentheses for reference.

6.2.1.8.3 CONFIG: CnC → Search-Delay

```
CnC Search Delay:          (range 0-330ms)
  Min: 010 ms   Max: 290 ms   ( ◀ ▶ ↕ )
```

You may apply restrictions to the range of delay used by the search. This will reduce the time it takes for the CnC algorithm to converge

Edit the **Min** or **Max** delay by using the ◀▶ arrow keys to select a digit. Then, use the ▲▼ arrow keys to change that digit. Press **ENTER**.

During initial link testing, you should set **Min** delay to **240 ms** and **Max** delay to **300 ms**. Once CnC finds the exact delay, you can further reduce the values, but you must take care to allow sufficient range to accommodate changes in path delay due to Doppler.



When you are bench-testing CnC with two units in a back-to-back configuration, the minimum delay should be set to 0 ms, and the maximum to 20 ms. This takes into account the lack of satellite delay.

6.2.1.8.4 CONFIG: CnC → PMSI-Control

```
CnC PMSI Mode: Idle
                (Idle, Redundancy, Talk, Listen) (◀▶)
```

The **Pre-Mapped Symbol Interface (PMSI)** is an RS-485 multi-drop bus system where one device transmits and all other devices on the multi-drop bus are configured to receive. Its function, as associated with DoubleTalk Carrier-in-Carrier, permits the modulator in a selected unit to provide a direct copy of its output (the outbound interferer) to one or many other modems. The other modem(s) may then choose to take the PMSI signal and use it for its own CnC reference. This applies to 1:1 and 1:N systems, and to certain other configurations.

To use this mode of operation, you must connect the appropriate cable to the PMSI connector on the rear panel of each modem:

- **For 1:N multi-drop applications** – Use Comtech EF Data cable P/N CA-0000275;
- **For 1:1 applications** – Use Comtech EF Data cable P/N CA-0000276.

Contact Comtech EF Data Product Support for further details about either cable.

Use the ▲▼ arrow keys to select the desired PMSI control configuration. Press **ENTER**. Valid settings are:

Setting	Function
Idle	Select when CnC is not used.
Redundancy	Select when CnC is used in a 1:1 or 1:N redundancy applications.
Talk	Select when CnC is used in other configurations, or for manual testing (the modem will transmit a copy of its baseband modulated signal on the PMSI port).
Listen	Select when CnC is used in other configurations, or for manual testing (the modem will receive the PMSI signal, and lock its modulator to this, permitting CnC to use the other modem's reference outbound interferer).

6.2.1.9 CONFIG: EDMAC



Appendix H. EDMAC CHANNEL

Embedded **D**istant-end **M**onitor **A**nd **C**ontrol (**EDMAC**) is a Comtech-proprietary framing that permits communication access to the distant-end modem.

Without the proper active framing mode, the menu appears as follows:

```
EDMAC Mode= Idle    (Idle,Master,Slave)
                                     ( ◀ ▶ ◆ )
```

You must otherwise use the CONFIG: Mode menu to set framing for EDMAC, EDMAC-2, EDMAC-3, or D&I++.

With the proper active framing mode, the menu appears as follows:

```
EDMAC Mode= Master (Idle,Master,Slave)
EDMAC Address= 0020      ( ◀ ▶ ◆ )
```

Use the ▲ ▼ arrow keys to select the mode as **Idle**, **Master**, or **Slave**. Press **ENTER**.

If the mode is **Master** or **Slave**, the bottom line shows an address. To edit the address, use the ◀ ▶ arrow keys to select a digit, and then use the ▲ ▼ arrow keys to change that digit. Press **ENTER**.

Note that:

- An EDMAC Master is a modem that is local to the M&C computer, and which passes messages, via the overhead, to a distant-end modem. The Master address always ends in '0'.
- An EDMAC Slave is a modem that is not local to the M&C computer. It is at the 'distant-end' of a satellite link. The Slave EDMAC address always ends in '1'. When configured as a **Slave**, reconfiguration is expected to be via the EDMAC link, and is therefore not permitted via the front panel or via serial remote control.

6.2.1.10 CONFIG: Misc

```
Misc:  G.703-LineCode  IDR-ESC  HSSI  RTS
Audio-Vol HiRateESC WarmUp Stats MEO ( ◀ ▶ )
```

Use the ◀▶ arrow keys to select a parameter. Press **ENTER**.

6.2.1.10.1 CONFIG: Misc → G.703-LineCode (Ternary Code)



This menu is functional only when the Data Interface Type is G.703.

```
Tx G.703/DDO Code= AMI  (AMI ,B8ZS)
Rx G.703/IDI Code= AMI  (AMI ,B8ZS) ( ◀ ▶ ◆ )
```

The selections displayed here depend on the selected G.703 interface type. Use the ◀▶ arrow keys to select either the G.703 *Tx* or *Rx* Ternary Code, and then use the ▲▼ arrow keys to select the desired code. Press **ENTER**.

Valid selections are:

Setting	For:
HDB3	E1, E2 or sub-rate operation (European standard)
B8ZS	T1 and Unbalanced T2 operation
B6ZS	Balanced T2 operation
AMI	Alternate Mark Inversion operation (North American standard)

6.2.1.10.2 CONFIG: Misc → IDR-ESC



This menu is functional only when the Framing Mode is IDR.

```
IDR-ESC-Type Tx: 64k Data  (64kData ,Audio)
Rx: 64k Data  ( ◀ ▶ ◆ )
```

Use this menu to determine if the 64 kbps channel in the IDR Engineering Service Channel (ESC) overhead, normally reserved for the two 32 kbps ADPCM audio channels, should instead carry user data. The rear panel '**IDR Data/Alarms/Audio**' connector provides the appropriate EIA-422 interface for this option.

Use the ◀▶ arrow keys to select a parameter, and then use the ▲▼ arrow keys to select its setting. Press **ENTER**.

6.2.1.10.3 CONFIG: Misc → HSSI



This menu is functional only when the Data Interface Type is HSSI.

```
HSSI handshake control:          (2 options)
    TA-> CA loop                    (◄)
```

Use the ▲▼ arrow keys to select HSSI handshake control as TA -> CA loop, RR cntl CA, or TA cntl Tx. Press ENTER.

6.2.1.10.4 CONFIG: Misc → RTS



This menu is functional only when the Data Interface is set for RS-422 or V.35.

```
RTS/CTS operation:              (3 options)
    Loop, RTS controls Tx-out      (◄)
```

Use the ▲▼ arrow keys to set the RTS/CTS control. Press ENTER. Valid selections are:

Setting	Function
RTS/CTS Loop, No Action	RTS and CTS are looped so that CTS echoes the state of RTS, but RTS does not control the ON/OFF state of the carrier.
Loop, RTS controls Tx out	RTS and CTS are looped so that CTS echoes the state of RTS, and RTS controls the ON/OFF state of the carrier (i.e., the modem will not bring up its TX carrier until RTS is asserted).
RxEnable	RTS is ignored and CTS is asserted unconditionally.

6.2.1.10.5 CONFIG: Misc → Audio-Vol (ADPCM Audio Volumes)

```
ADPCM    Tx1 = +0 dB    Tx2 = -2 dB
Volumes: Rx1 = +2 dB    Rx2 = -4 dB  (◀ ▶ ◄)
```

Use this menu to adjust the gain (or volume) of the audio ESC circuits for both Transmit (Tx) and Receive (Rx). Use the ◀▶ arrow keys to select the volume to edit, and then use the ▲▼ arrow keys to change the value. The allowable range of the volumes is -6 dB to +8 dB, in 2 dB steps. Press ENTER.

6.2.1.10.6 CONFIG: Misc → HiRateESC

```
High-Rate-ESC=Off (Off,On)      RS-232
2400 baud      DataParityStop=8N1  ( ◀ ▶ ⬆ )
```

The ESC (Engineering Service Channel) is determined by the framing type (**IBS**, **D&I**, or **ESC++**) selected under **CONFIG: Mode**. The High Rate IBS (Engineering Service Channel) requires the Open Network **FAST** option. Both Tx and Rx Framing must be configured as **IBS** or **D&I** for this feature to be enabled. When enabled, the lower of the Tx or Rx primary data rate limits the maximum baud rate as follows:

Data Rate	Max ESC Baud Rate
64 kbps	2400
≥ 128 kbps	4800
≥ 256 kbps	9600
≥ 384 kbps	14400
≥ 512 kbps	19200
≥ 768 kbps	28800
≥ 1024 kbps	38400



Appendix P. OPEN NETWORK OPERATIONS

ESC++ is available as standard. Both Tx and Rx framing must be set to ESC++. When you enable ESC++, the lower of the Tx or Rx primary data rate limits the maximum baud rate as follows:

Data Rate	Max ESC++ Baud Rate
≥ 64 kbps	4800
≥ 128 kbps	9600
≥ 192 kbps	14400
≥ 256 kbps	19200
≥ 384 kbps	28800
≥ 512 kbps	38400



Appendix J. ESC++

Use the ◀▶ arrow keys to select a parameter to edit. Then, use the ▲▼ arrow keys to select its setting, and press **ENTER**. Valid selections are:

- High-Rate-Esc operation: **Off** or **ON**.
- **RS-232** or **RS-485**.
- *Baud rate* (range depends on other configuration parameters, previously noted).
- *Character format* (number of data bits, parity, number of stop bits): **8N1** (8-None-1), **7E2** (7-Even-2) or **7O2** (7-Odd-2).

6.2.1.10.7 CONFIG: Misc → Warm-Up

```
High-Stab Reference Warm-Up Delay:
Enabled (None, Enable) (◆)
```

The High-Stability Reference Module contains an oven for its crystal. During the short time it takes for the oven and crystal to come up to temperature, frequency accuracy is not guaranteed.

Use this menu to select a Warm-up Delay that executes upon power-up. This delay is calculated by the modem and is based on temperature and the amount of time the unit was turned off. This is much more important at L-Band (950-2250 MHz) than at 50-180 MHz, where the 10 MHz reference may also be used for RF conversion equipment.

Once this feature is enabled and the modem is powered up, a Warm-Up Delay Countdown is activated during which time the Tx is suppressed. This countdown displays in decremented fashion as shown in this example:

```
Comtech CDM-625A Advanced Satellite Modem
High-Stability Ref warming up: 045 sec
```

Press the **CLEAR** key to bypass this warm-up period as needed.

6.2.1.10.8 CONFIG: Misc → Stats (Statistics)

```
Link Statistics Logging Interval:
10 minutes (00 to 90) (◆)
```

The Logging Interval is the period over which performance statistics are to be measured. Use the **▲ ▼** arrow keys either to set this interval as **00** to disable the feature (i.e., no logging), or to select a logging interval, in 10-minute increments, from **10** through **90** minutes. Press **ENTER**.

Access the '**SELECT: Monitor → Statistics**' menu (Sect. 6.2.3.4) to view compiled Statistic logs.

6.2.1.10.9 CONFIG: Misc → MEO (Medium Earth Orbit)

```
MEO: Enable/Disable
(MEO requires ACM, PaP, and no Cnc)
```



MEO is non-functional when CnC is enabled.

CDM-625A Advanced Satellite Modems are configurable for continuous pairing as Primary and non-Primary Modems in an Antenna Handover System when the MEO (Medium Earth Orbit) feature is enabled.

Ethernet data traffic is transmitted and received via the Primary and Non-Primary CDM-625's four 10/100 Ethernet ports. The Antenna Handover signal received from the user-provided IF/RF switch determines which modem is the ONLINE or OFFLINE unit:

- The ONLINE unit transmits traffic only to the WAN side while, at the same time, the OFFLINE unit's Tx is muted.
- Both the ONLINE and OFFLINE units receive the satellite traffic, but only the ONLINE unit forwards traffic to the LAN side while the OFFLINE unit drops the packets.
- Any time a unit switches from the OFFLINE to ONLINE state, the traffic destined for the WAN is buffered, preconfigured in milliseconds (base modem → Antenna Handover delay).

Press **ENTER** to open the **Enable/Disable** menu.

CONFIG: Misc → MEO → Enable/Disable

```
MEO Features: Enabled (Enabled,Disabled)
                Antenna Handover (◀ ▶ ⬆)
```

On the top line, the ▲▼ arrow keys to select the MEO feature as **Enabled** or **Disabled**. Press **ENTER**. Once the MEO feature is **enabled**, you may now use the ◀▶ arrow keys to navigate to the bottom line. Select **Antenna Handover**, and then press **ENTER** to continue.

CONFIG: Misc → MEO → Enable/Disable → Antenna Handover

```
Antenna Handover: Enabled          DPD = 00
Mode = Manual      Port = 05501    (◀ ▶ ⬆)
```

Use the ◀▶ arrow keys to navigate to the proper line:

First, on the top line:

Use the ◀▶ arrow keys to select the Antenna Handover operational control and to set the DPD (Differential Path Delay) limit.

- To set the Antenna Handover operation, use the ▲▼ arrow keys to select operation as **Enabled** or **Disabled**.
- To set a value for the DPD limit for this unit, use the ▲▼ arrow keys to select a DPD value from **-30** to **(+)30**.

Then, on the bottom line:

Use the ◀▶ arrow keys to select the Antenna Handover switching mode and to assign the Communication Port Address.

- Use the ▲▼ arrow keys to set the Antenna Handover switching mode as **Manual** or **Auto**.
- Set the Communication Port Address for this unit by using the ◀▶ arrow keys to select a digit. Then, use the ▲▼ arrow keys to change that digit. The valid address range is from 01001 to 65535. Press **ENTER**.

Press **CLEAR** to return to the MEO Feature (Enable/Disable) menu.

6.2.1.11 CONFIG: Mask

These submenus allow you to selectively mask (ignore) or make active various alarms and traffic conditions that are monitored by the modem.

```
Alarm Masks: AIS Buffer/Ref RxIF TxClk  
CnC TxSat RxSat Terr BUC LNB ClkExt (◀▶)
```

Use the ◀▶ arrow keys to select a parameter. Press **ENTER**.

6.2.1.11.1 CONFIG: Mask → AIS

```
AIS: Tx-Terr-AIS = Masked (Active,Mask)  
Rx-Sat-AIS = Active (◀▶◆)
```

Use the ◀▶ arrow keys to select **Tx-Terr-AIS** or **Rx-Sat-AIS**, and then use the ▲▼ arrow keys to select either as **Active** or **Masked**. Press **ENTER**.

Note that:

- When you select **Tx-Terr-AIS** as **Active**, the modem generates a fault whenever the modulator senses that the 'all ones' condition is present in the terrestrial data.
- When you select **Rx-Sat-AIS** as **Active**, the modem generates a fault whenever the demodulator senses that the 'all ones' condition is present in the receive data.
- Typical for either, when you select **AIS** as **Masked**, the modem generates no alarms.

6.2.1.11.2 CONFIG: Mask → Buffer/Ref

```
Buffer Slip Alarm = Active (Active,Mask)  
Reference Alarms = Active (◀▶◆)
```

Use the ◀▶ arrow keys to select **Buffer Slip Alarm** or **Reference Alarms**. Then, typical for either choice, use the ▲▼ arrow keys to select **Active** or **Masked**.

When you select the Buffer Slip Alarm as **Active**, the modem generates a *Buffer Slip Rx Fault* whenever the Rx circuitry senses that the buffer is either underflowing or overflowing. Press **ENTER**.

6.2.1.11.3 CONFIG: Mask → RxIF

```
RxIF Alarms: AGC=Active (Active,Mask)
              EbNo=Masked (◀▶◆)
```

Use the ◀▶ arrow keys to select **AGC** or **EbNo**. Then, typical for either choice, use the ▲▼ arrow keys to select the alarms as **Active** or **Masked**. Press **ENTER**.

Note that:

- Selecting the AGC Rx IF Alarm as **Active** generates an **AGC fault** whenever the receive signal level exceeds –20 dBm (for the desired carrier).
- Selecting the EbNo Rx IF Alarm as **Active** generates an **Eb/No fault** whenever the demodulator sees the receive **Eb/No** fall below the pre-determined value.
- Typical for either, when you select **Masked**, the modem generates no alarms.

6.2.1.11.4 CONFIG: Mask → TxClk

```
Tx Clock Alarm: = Masked (Active,Masked)
                 (Valid in G.703 & Ext clock modes) (◆)
```

Use the ▲▼ arrow keys to select the Tx Clock Alarm as **Active** or **Masked**. Press **ENTER**.

Note that:

- When you select the Tx Clock Alarm as **Active**, the modem generates a Tx Traffic alarm if a G.703 interface is active and the input is lost or removed, or when you select another interface type where the Tx Clock mode is External and the clock is lost or removed.
- When you select the **Masked**, the modem generates no alarm.

6.2.1.11.5 CONFIG: Mask → CnC

```
CnC Lock Alarm: = Masked (Active,Masked)
                  (◆)
```

Use the ▲▼ arrow keys to select the CnC Lock Alarm as **Active** or **Masked**. Press **ENTER**.

6.2.1.11.6 CONFIG: Mask → TxSat (Satellite Tx Alarms)

```
Process Alarms from          (Off,H/W,S/W)
  BWA1=Off  BWA2=Off  BWA3=S/W  BWA4=H/W
```

To determine how to use the **Tx IDR** backward alarm inputs, you may disable the alarm (**Off**); otherwise, an active alarm may respond to a hardware input at P5A (**H/W**) or be software controlled by a receive fault on the modem (**S/W**).

Use the ◀▶ arrow keys to select which **Backward Alarm** to configure – **BWA1**, **BWA2**, **BWA3**, or **BWA4** – and then use the ▲▼ arrow keys to set that alarm as **Off**, **H/W**, or **S/W**. Press **ENTER**.

6.2.1.11.7 CONFIG: Mask → RxSat (Satellite Rx Alarms)

```
Process Alarms received from Satellite
  BWA1=N  BWA2=N  BWA3=N  BWA4=N      (Yes,No)
```

Use the ◀▶ arrow keys to select which **Rx IDR** backward alarms to monitor – **BWA1**, **BWA2**, **BWA3**, or **BWA4** – and then use the ▲▼ arrow keys to select **Yes** (to monitor) or **No** (to mask). Press **ENTER**.

6.2.1.11.8 CONFIG: Mask → Terr



These alarms are applicable only to D&I operation.

```
Terr-Alm: Tx= Active   (Active,Mask)
           Rx= Off     (Off,Enabled) (◀▶◆)
```

Use the ◀▶ arrow keys to select **Tx** or **Rx** and then, typical for either, use the ▲▼ arrow keys to set that alarm as **Active** or **Masked**. Press **ENTER**.

6.2.1.11.9 CONFIG: Mask → BUC



Chapter 10. CDM-625A ODU (TRANSCEIVER, BUC, LNB) OPERATION

```
BUC alarm = Active          (Active,Mask)
Attach to Tx alarm = No    (Yes,No) (◀▶◆)
```

When L-Band is in use, you may include a Block Up Converter (BUC) in the operating system. You may monitor and control a 'smart' BUC via the modem using FSK (**F**requency-**S**hift **K**eying

control). For a modem in a 1:1 redundancy setup, you must customize the fault indications for the physical setup.

6.2.1.11.10 CONFIG: Mask → LNB



Chapter 10. CDM-625A ODU (TRANSCEIVER, BUC, LNB) OPERATION

```
LNB alarm = Active          (Active,Mask)
Attach to Rx alarm = No    (Yes,No) (◀ ▶ ◆)
```

When L-Band is in use, you may include a Low-Noise Block Down Converter (LNB) in the operating system. You can use the modem only to monitor and control the power supply values. For a modem in a 1:1 redundancy setup, you must customize the fault indications for the physical setup.

6.2.1.11.11 CONFIG: Mask → ClkExt (G.703 Clock Extension Mask)

```
G.703 Clock Extension = Active
(Active, Masked)          (◆)
```

Use the ▲ ▼ arrow keys to select **Active** or **Masked**. Press **ENTER**.

When you select **Active**, the modem generates a **ClkExt** (Clock Extension) alarm if the G.703 Clock Extension mode is set to TxLock and the input is lost or removed from the G.703 interface.

6.2.1.12 CONFIG: Remote (Remote Control)

```
Remote Control=Local
                (Local,Serial remote,Ethernet)    (◆)
```

Use the ▲▼ arrow keys to select **Local**, **Serial remote**, or **Ethernet**. Press **ENTER**.

When you select **Local**, you are not permitted to reconfigure the modem via **Serial Remote** or **Ethernet**, although remote monitoring is permissible. When you select **Local** or **Serial Remote**, the modem displays a common submenu – proceed to the next section for details.

6.2.1.12.1 CONFIG: Remote → Local or Serial Remote Settings

```
Interface= RS-485-4W    (232,485-2,485-4)
Address= 0001          9600 baud    (◀▶◆)
```

When you select either **Local** or **Serial remote** control, use the ◀▶ arrow keys to select **Interface**, **Address**, or **Baudrate**. Then, use the ▲▼ arrow keys to edit the Interface type, Baudrate, and each digit of the Address.

Note that:

- Character format is not selectable and is fixed at 8-N-1.
- **For RS-485 (aka EIA-485)** – The permitted address range is from **0001** to **9999**. Address 0000 is reserved for universal addressing.
- **For RS-232 (aka EIA-232)** – The Address is fixed at 0000.

6.2.1.13 CONFIG: IP

```
IP Config:  Addresses  SNMP  Setup  ANT
PortMonitor AccessList  PktP-Enable(◀ ▶)
```

Use the ◀▶ arrow keys to select a parameter. **PktP-Enable** displays *only* when you install the optional IP Packet Processor card.

Press **ENTER** to continue.

6.2.1.13.1 CONFIG: IP → Addresses

```
IP Addresses:      MAC      Gateway
  Addr/Range                (◀ ▶)
```

Use the ◀▶ arrow keys to select **MAC**, **Gateway**, or **Addr/Range**. Press **ENTER**.

CONFIG: IP → Addresses → MAC

```
Ethernet MAC Address:
  00-06-B0-00-01-06      (read-only)
```

This screen displays the *read-only* unit MAC address.

Press **ENTER** or **CLEAR** to return to the previous menu.

CONFIG: IP → Addresses → Gateway

```
Ethernet IP Gateway:
  192.168.001.002      (◀ ▶ ◆)
```

Edit the IP Gateway Address for the Ethernet M&C port for this unit by using the ◀▶ arrow keys to select a digit. Then, use the ▲▼ arrow keys to change that digit. Press **ENTER**.

CONFIG: IP → Addresses → Address/Range

```
Ethernet IP Address/Range:
  192.168.001.002/24    (◀ ▶ ◆)
```

Configure the IP Address for the Ethernet M&C port for this unit by using the ◀▶ arrow keys to select a digit. Then, use the ▲▼ arrow keys to change that digit. Press **ENTER**.

6.2.1.13.2 CONFIG: IP → SNMP

```
SNMP:
  Communities      Traps      ( ◀ ▶ )
```

Use the ◀▶ arrow keys to select **Communities** or **Traps**. Press **ENTER**.

CONFIG: IP → SNMP → Communities

```
SNMP Communities:
  Read      Write      ( ◀ ▶ )
```

Use the ◀▶ arrow keys to select **Read** or **Write**. Press **ENTER**.

CONFIG: IP → SNMP → Communities → Read

```
SNMP Read Community:
Public                               (20 chars) ( ◀ ▶ ◆ )
```

Edit the SNMP Read Community string by using the ◀▶ arrow keys to select a character. Then, use the ▲▼ arrow keys to change that character, and press **ENTER**.



Only the first 20 characters on the bottom line are available.

All printable ASCII characters are available, except for the backslash (ASCII code 92) and tilde ~ (ASCII code 126). Press **ENTER** after composing the string. All trailing spaces are removed from the string upon entry.

CONFIG: IP → SNMP → Communities → Write

```
SNMP Write Community:
Private                               (20 chars) ( ◀ ▶ ◆ )
```

Edit the SNMP Write Community string by using the ◀▶ arrow keys to select a character. Then, use the ▲▼ arrow keys to change that character, and press **ENTER**.



Only the first 20 characters on the bottom line are available.

All printable ASCII characters are available except for the backslash (ASCII code 92) and tilde ~ (ASCII code 126). Press **ENTER** after composing the string. All trailing spaces are removed from the string upon entry.

CONFIG: IP → SNMP → Traps

```
Traps:      Community      Version
           IP-Addr#1      IP-Addr#2      ( ◀ ▶ )
```

Use the ◀▶ arrow keys to select a parameter. Press **ENTER**.

CONFIG: IP → SNMP → Traps → Community

```
SNMP Traps Community:
Comtech                (20 chars)  ( ◀ ▶ ◆ )
```

Edit the SNMP Traps Community string by using the ◀▶ arrow keys to select a character. Then, use the ▲▼ arrow keys to change that character, and press **ENTER**.



Only the first 20 characters on the bottom line are available.

All printable ASCII characters are available with the exception of the backslash (ASCII code 92) and tilde ~ (ASCII code 126). Press **ENTER** after composing the string. All trailing spaces are removed from the string upon entry.

CONFIG: IP → SNMP → Traps → Version

```
SNMP Traps Version:
SNMP-ver1      (ver1,ver2)      ( ◆ )
```

Use the ◀▶ arrow keys to select **SNMP-ver1** or **SNMP-ver2**. Press **ENTER**.

CONFIG: IP → SNMP → Traps → Address

```
Trap IP addr #1:
000.000.000.000      ( ◀ ▶ ◆ )
```

Edit the SNMP Trap Destination's IP Address by using the ◀▶ arrow keys to select a digit. Then, use the ▲▼ arrow keys to change that digit, and press **ENTER**.

You may disable SNMP Traps by setting both Trap IP Addresses as **000.000.000.000**.

6.2.1.13.3 CONFIG: IP → Setup

```
IP Setup: Mode WAN PerPortCnfg DDMgmtPt
MAC-Lrng Rad VLAN QoS Stats FrmSize (◀ ▶)
```

Use the ◀▶ arrow keys to select a parameter. Press **ENTER**.

6.2.1.13.3.1 CONFIG: IP → IP Setup: Mode

```
Working Mode: Router Point to Point
(ManagedSwitch,R-PtoP, R-MPHub,R-MPRm) (⬆ ⬇)
```

Use the ◀▶ arrow keys to select **ManagedSwitch**, **R-PtoP** (Router Point-to-Point), **R-MPHub** (Router Multipoint-to-Hub), or **R-MPRm** (Router Multipoint-to-Remote). Press **ENTER**.



If the optional IP Packet Processor card is either **not installed** or **installed but disabled**, the mode is “Fixed at Managed Switch Mode”.

6.2.1.13.3.2 CONFIG: IP → IP Setup: WAN

```
WAN:      Buffer Length = 240ms
Avg Buffer Fill State = 00% (⬆ ⬇)
```

On the top line – Use the ▲▼ arrow keys to edit the WAN Buffer Length. Press **ENTER**. Valid settings are:

Minimum	Maximum	Step Size (Increment)
20ms	400ms	20ms

Press **ENTER**. Packets are dropped when the buffer is exceeded.

On the bottom line (read-only) – The percentage of the Average WAN Buffer Fill State displays across a 4-second duration.



When you **install and enable** the optional IP Packet Processor card, the WAN submenu is non-functional and displays as follows:

```
WAN:      Buffer Length = N/A due to PktP
Avg Buffer Fill State = xx% (⬆ ⬇)
```

6.2.1.13.3.3 CONFIG: IP → Setup: PerPortCnfg

```
Per-Port-Config:
  Port1  Port2  Port3  Port4      ( ◀ ▶ )
```

Use the ◀▶ arrow keys to select **Port1** through **Port4**. Press **ENTER**.

CONFIG: IP → IP Setup: PerPortCnfg → Port#

Where # denotes the selected Port:

```
Port#:  Pause=Off      NegoSpeed:LinkDwn
Speed=Auto  (Auto,100F/H,10F/H)      ( ⬆ )
```

On the top line – Set Pause Frame Flow Control on a *per port* basis. Use the ▲▼ arrow keys to set this control as **On** or **Off** (default is **Off**). To turn Pause on for the active (selected) port, you must meet the following conditions:

- 1) Tx Data Rate or IP Info Rate (if Sub-Mux is on), or a data rate calculated based on ModCod00 from the Symbol Rate in ACM, must be at least 128 kbps.

-and-

- 2) WAN Buffer Length (see the important WAN Buffer Notes that follow).

This menu displays actual negotiated speed (**NegoSpeed:**) as a *read-only* status item.

On the bottom line – Use the ▲▼ arrow keys to select the desired speed setting. Valid settings are:

Setting	Function
Auto	Sets the port speed as Auto Negotiated. This allows the ports to negotiate speed and half/duplex operation.
100Full	Forces the Port to 100/Full.
100Half	Forces the Port to 100/Half.
10Full	Forces the Port to 10/Full.
10Half	Forces the port to 10/Half.



WAN Buffer Notes:

What is the WAN Buffer?

Wan Buffer is applicable when the optional IP Packet Processor is **not installed**. It is a special FIFO structure that exists between the IP Packet Processor’s packet encapsulator and the Modulator path.

When the rate at which packets received from the LAN side approaches the maximum rate the modem can handle, the FIFO acts as an elastic buffer that will store a packet, or packets, on a temporary basis. If the WAN Buffer capacity is exceeded, it will drop IP packets at exact packet boundaries. This causes the minimum impact to the IP link.

What does the WAN Buffer size mean?

The WAN Buffer is sized in milliseconds. It can range from a minimum of 20 ms to a maximum of 400 ms. The maximum number of bits the WAN Buffer can hold is given by:

$$\text{Size in bits} = \text{modem Tx bit rate} * \text{buffer size}$$

(where Tx bit rate is expressed in kbps, and buffer size is expressed in milliseconds)

For example, if Tx bit rate = 1000 kbps, and WAN Buffer size = 100 ms, size in bits = 100,000.

The corresponding size in bytes = 12.5 kbytes.

Therefore, in the example shown, the WAN Buffer can store just over 8 packets with a size of 1500 bytes.

Does the WAN Buffer size affect latency?

Yes and No:

- When **Yes** – When the LAN is over-driving the modulator (the rate at which packets are being received exceeds the capacity of the data rate set for the modulator) the WAN Buffer will constantly fill, and this will add latency, up to the maximum programmed size. If the LAN constantly over-drives the Modulator, packets will be dropped, and re-transmission will be required.
- When **No** – When the router or other device on the LAN side is effectively rate-limiting the flow of data to the modulator (to a value less than the Tx data rate of the Modulator), the WAN Buffer should not be filling, and will not add latency to the link. Momentary packet congestion may cause the WAN Buffer to fill (and hence increase latency on temporary basis) but as soon as the congestion clears the latency will return to near zero.

What about Pause Frames?

In cases where the router (or other attached device) does not have the capability to rate limit, Pause Frame Flow Control may be used to stop the WAN Buffer from dropping packets. In this case, if the WAN Buffer depth exceeds 80%, a Pause Frame will be sent back to the LAN to instruct the router (or other attached device) to stop sending data until the WAN Buffer depth has reduced.

This is particularly useful in the case where ACM is being used.

What is the recommended setting for the WAN Buffer size?

There are too many variables to provide an answer for all cases. We recommend starting with the default size, and then, based on the Tx bit rate of the modem and the rate coming in from the LAN side, adjusting the size until zero packet drops (or an acceptably low rate) is achieved for the type and packet size of traffic being transmitted.

The IP statistics screens on the Web and front panel screens can be used to look at the packets being received from the LAN versus the number of packets being sent over the satellite, which in turn should give guidance on how to adjust the rate limiting on the LAN side, or Tx data rate of the modulator.

What if you install the optional IP Packet Processor?

In this case, the encapsulation and buffering of packets is handled differently (through QoS, for example), and the WAN Buffer is not used.

Comtech EF Data highly recommends the use of the optional IP Packet Processor module, particularly for ACM operation.

6.2.1.13.3.4 CONFIG: IP → IP Setup: DDMgmtPt (Dedicated Management Port)

```
Dedicated Mgmt Port: Port1      (Dis,P1-P4)
Local-only: No (Yes,No)      (◀ ▶ ◆)
```

Use **Dedicated Management Port mode** in redundancy applications. When a redundant CDM-625A is *Offline* (Standby), **all four** of the offline modem's Ethernet ports are disabled unless you first configure one of the four ports as the "Dedicated Management Port".

Use the ◀▶ arrow keys to select between **Dedicated Mgmt Port** (on the top line) or **Local-only** (on the bottom line).

On the top line – Use the ▲▼ arrow keys to set the "Dedicated Management Port" as **Disabled**, **Port1**, **Port2**, **Port3**, or **Port4**.

On the bottom line – Use the ▲▼ arrow keys to set "Local-only" mode as **Yes** or **No**.

Local-only mode limits the modem management access only to the designated Dedicated Management (LAN) Port. It will not transmit any packets to the distant-end (remote) modem when the packets originate from this designated port.

Local-only mode:

- Allows the local modem management access through the assigned Dedicated Management Port.
- Does not allow the local modem management access through any other port that is not designated as a Dedicated Management Port.
- Does not allow management access to the distant-end modems from the local modem's assigned Dedicated Management Port.
- Does not allow management access to the local modem from any distant-end modem, whether or not that modem has an assigned Dedicated Management Port.

6.2.1.13.3.5 CONFIG: IP → IP Setup: MAC-Lrng (MAC Learning)



You must cycle unit power whenever enabling or disabling MAC Learning Mode.

```
MAC learning:
  Off (Off, On)      (◆)
```

MAC Learning is an Ethernet switch function that allows the LAN (user) side of the Ethernet ports to learn the MAC addresses of the equipment connected to those ports.

Use the ▲ ▼ arrow keys to select MAC Learning as **On** or **Off**:

- When you select **On** (*enabled*), the interface is in LAN-to-WAN learning mode, and the switch learns the connections based on source MAC addresses and ingress ports.

Learning applies only to the LAN (user) side of the Ethernet ports. There is no learning on the WAN (modem) side of the ports.

Once the switch learns the connections, it will not send any more packets destined to local node over WAN.

- When you select **Off** (*disabled*), the interface passes all packets from the LAN to the WAN.

Press **ENTER**, ***and then cycle the unit power.***

6.2.1.13.3.6 CONFIG: IP → IP Setup: Rad (Remote Authentication Dial In User Service)



- Chapter 7. ETHERNET-BASED REMOTE PRODUCT MANAGEMENT
- Chapter 8. SERIAL-BASED REMOTE PRODUCT MANAGEMENT
- Appendix T. CDM-625A RADIUS CLIENT



- 1) You must first set CONFIG: MODE to IP or IP-ACM in order to use this menu.
- 2) RADIUS operating parameters may be configured by the Administrator via the CDM-625A HTTP (Web Server) Interface Admin | Access page, or by issuing Telnet-restricted remote commands.

```
Radius: Disabled (Enabled, Disabled) (↕)
```

Use the ▲ ▼ arrow keys to select RADIUS as **Enabled** or **Disabled**. Press ENTER.

6.2.1.13.3.7 CONFIG: IP → IP Setup: VLAN



The CONFIG: IP → Setup → VLAN menu and its available submenus and operations described hereafter, are operational only when the IP Working Mode is set as ManagedSwitch mode (see Sect. 6.2.1.13.3).

```
VLAN: Disabled (Dis,Ena)   Mgmt-VLAN=0001  
PortMode      VLAN-Table   (◀ ▶ ↕)
```

VLAN Operation – Use the ◀ ▶ arrow keys to first select this operation parameter, and then use the ▲ ▼ arrow keys to set VLAN Operation as **Disabled** or **Enabled**.

Mgmt-VLAN – Configure a Management Port’s VLAN ID by using the ◀ ▶ arrow keys to select a digit, and then using the ▲ ▼ arrow keys to change that digit. The value range is from 1 to 4095.



Hold down the ▲ ▼ arrow keys to quickly scroll between 1 and 4095.

PortMode or **VLAN-Table** – Use the ◀ ▶ arrow keys to select either parameter from the VLAN submenu. Press ENTER.

CONFIG: IP → IP Setup: VLAN → PortMode

```
Port Mode:  
Port1  Port2  Port3  Port4   (◀ ▶)
```

Use the ◀ ▶ arrow keys to select **Port1**, **Port2**, **Port3** or **Port4**. Press ENTER.

CONFIG: IP → IP Setup: VLAN → PortMode → Port#

Where # denotes the selected Port:

```
Port #: Port Mode= Trunk
                PVID=N/A          (◀ ▶ ⬇)
```

Use the ◀▶ arrow keys to select the operation parameter. Then, use the ▲▼ arrow keys to select **Trunk** or **Access**:

- When you select **Trunk** as the Port Mode, VLAN ID (PVID) **does not apply**. On the bottom line of the display, the selected port's PVID will display as **PVID=N/A**.
- Otherwise, when you select **Access** as the Port Mode you must configure the VLAN IDs (PVIDs). Edit the PVID by using the ◀▶ arrow keys to select a digit. Then, use the ▲▼ arrow keys to change that digit, and then press **ENTER**. You may create a PVID in the range from 0001 to 4095. The default is 0001.



Hold down the ▲ ▼ arrow keys to quickly scroll between 0001 and 4095.

CONFIG: IP → IP Setup: VLAN → VLAN-Table

```
VLAN Table:
View/Edit/Delete  Add-Entry      (◀ ▶)
```

The VLAN table supports up to 32 entries. Use the ◀▶ arrow keys to select **View/Edit/Delete** or **Add-Entry**. Press **ENTER**.

CONFIG: IP → IP Setup: VLAN → VLAN-Table → View / Edit / Delete

```
VLAN ID:0001 P1:Filtered P2:Untagged
P3:Tagged P4:Untagged ACT=None (N,E,D)
```

Do these steps to view, edit, or delete existing VLAN IDs:

- *First*, use the ◀▶ arrow keys to select the desired parameter:
 - **VLAN ID** – Selects the tabulated VLAN ID. After selecting VLAN ID, use the ▲▼ arrow keys to scroll through the available VLAN IDs.
 - **ACT** – Choose an *action* to undertake for the selected VLAN ID – **NONE** (default), **Edit**, or **Del** (Delete).
 - **P1** (Port1) through **P4** (Port4) – With **ACT=Edit** active, you may update the selected port's behavior attributes, as assigned under the selected VLAN ID.

Your options are as follows:

- **View**, without changing, the behavior attributes assigned to each port under the selected VLAN ID: **ACT=NONE** (default).
- **Edit** the behavior attributes assigned to each port under the selected VLAN ID. Once the VLAN ID targeted for editing is selected, use the ◀▶ arrow keys to select the ACT parameter, and then use the ▲ ▼ arrow keys to select **ACT=Edit**.
- Next, to change the behavior attribute of a specific port as needed, use the ◀▶ arrow keys to select **P1, P2, P3, or P4**. Then, use the ▲ ▼ arrow keys to designate the attribute for that port as **Tagged** or **Filtered** for a Trunk port, or **Untagged** or **Filtered** for an Access port.



The “Untagged” option is available only when Port Mode has been set to Access for the selected port.

You may not designate the behavior attributes for all four ports as “Filtered” – is this is done, and you Presses ENTER to save this configuration change, an error message will display as follows:

```
ERROR: Entry with FILTERED on all ports
is not allowed.
```

Once the port attributes have been changed (with **ACT=Edit** active), press **ENTER** to save those changes. **ENTER** *must* be pressed to **save** the change. **CLEAR** will **discard** the change.

You must take into consideration, when editing VLAN table entries, the following rules:

- The modem cannot filter VLAN 1.
- All **Untagged/Tagged** packets arriving at the LAN port are tagged (four byte **VLAN** “frame” is added) with the configured **VLAN ID**.
- If the port is in **Port Mode**, any packet arriving from the WAN that matches this **PVID** will have the **VLAN** tag removed and passed out the Ethernet.
- If the port is in **Port Mode** and the packet does not match the **PVID**, the **VLAN** table must be checked to determine if the packet should pass. Packets leaving a port in Port Mode are always untagged.
- If the port behavior Port Mode attribute is set to Trunk, then the **VLAN** table is referenced to determine if the packet should pass. In this mode, packets will either be filtered (dropped) or passed “as is” with the VLAN header intact.

- **Delete** the selected **VLAN ID**. After targeting a **VLAN ID** for deletion, use the ◀▶ arrow keys to select the **ACT** parameter, and then use the ▲▼ arrow keys to select **ACT=Del**. Press **ENTER** to execute deletion of the selected VLAN ID.



You must take into consideration that, when deleting VLAN IDs, an entry associated with an enabled PVID cannot be deleted.

CONFIG: IP → IP Setup: VLAN → VLAN-Table → Add-Entry

```
VLAN ID:???? P1:Tagged P2:Tagged
P3:Tagged P4:Untagged ADD (◀▶◆)
```

Do these steps to add new entries to the VLAN table:

- *First*, use the ◀▶ arrow keys to select the **????** numerical string following the **VLAN ID:** parameter.
- *Then*, use the ▲▼ arrow keys to replace the string with a new VLAN ID.



Hold down the ▲▼ arrow keys to quickly scroll between 1 and 4095.

- *Next*, use the ◀▶ arrow keys to select the port (**P1/Port1** through **P4/Port4**), and then use the ▲▼ arrow keys to set the behavior attribute for that port as **Tagged**, **Filtered**, or **Untagged**.



The port attribute assignment restrictions explained previously apply.

- Once you assign the VLAN ID and the port behavior attributes, press **ENTER** to create the new entry. The modem then returns you to the previous menu.

Note that:

- When you attempt to add an entry that is named identically to an existing VLAN ID, you will see an error message:

```
ERROR: vid already exists in table
```

- When you attempt to add a new entry, and the VLAN table has already reached the 32 maximum allowable entries, you will see an error message:

```
Can not add new entry!
VLAN table is FULL!
```

You must follow these rules when creating or adding a VLAN table entry:

- The VLAN ID (0001-4095) must be unique – it cannot be a duplicate of any previously assigned VLAN ID, including PVIDs in the VLAN ID table.
- If a port is not in Trunk Mode (PortMode = Trunk), the behavior attribute for each port may be set as **Tagged** or **Filtered**.



For any VLAN ID (Trunk Mode) created, at a minimum, one port must be defined as ‘Tagged’.

You must follow these rules when assigning PVIDs:

- The PVID (0001-4095) must be unique – it cannot be a duplicate of any previously assigned VLAN ID, including PVID. The only exception to this rule is that the default value 0001 may be assigned as the PVID for all ports.
- If a port is in Access Mode (Port Mode = Access), the behavior attribute for each port may be set as **Untagged** or **Filtered**.
- PVIDs are automatically **ENTERed** into the VLAN ID Table when changed.
- When a new PVID entry is added to the VLAN ID Table, the “other” ports will default to **Filtered**.
- When a PVID is changed, the entry in the VLAN ID Table for that port will change to **Filtered**. If the rest of the ports are also **Filtered**, then *delete* that entry. If any other port has been marked **Tagged**, leave the entry in the table.

THESE EXAMPLES OF THE VLAN PORT CONFIGURATION AND ID TABLES ARE PROVIDED FOR USER REFERENCE:

VLAN Port Configuration		
Port	Port Mode	Native VLAN ID
1	Trunk	N/A
2	Trunk	N/A
3	Trunk	N/A
4	Access	3400

VLAN ID Table				
VLAN ID	Port 1	Port 2	Port 3	Port 4
344	Tagged	Filtered	Tagged	Filter
454	Filtered	Tagged	Tagged	Untagged (Access mode)
3400	Filter	Tagged	Filter	Untagged (Access mode)

6.2.1.13.3.8 CONFIG: IP → IP Setup: QoS (Quality of Service)



Appendix R. QUALITY OF SERVICE (QoS)

QoS functionality depends on whether the optional IP Packet Processor card is either a) **not installed** or **installed but disabled**, or b) **installed and enabled**.

```
QoS Mode: L2 QoS    L3 QoS
                ( ◀ ▶ )
```

Use the ◀▶ arrow keys to select the basic QoS setup as **L2 QoS** or **L3 QoS**:

- Select **L2 QoS** (Layer 2) when the optional IP Packet Processor card is either **not installed** or **installed but disabled**.
- Select **L3 QoS** (Layer 3) when the optional IP Packet Processor card is **installed and enabled**. L3 QoS is required to support IP Packet Processor Managed Switch Mode.

Press **ENTER** to continue.

CONFIG: IP → IP Setup: QoS →L2 QoS

```
L2 QoS=Off      (Off, VLAN, PT, VLAN&Port)
                ( ◀ ▶ ⬆ )
```

Use the ▲▼ arrow keys to set the L2 QoS operational priority. Press **ENTER**.

Valid selections are:

Setting	Function
Off	QoS disabled.
VLAN	(VLAN Priority only) QoS traffic prioritization is applied based on the priority bits in the LAN ingress packet's VLAN tag.
PT	(Port Priority only) QoS traffic prioritization is applied based on LAN ingress traffic port.
VLAN&Port	(VLAN and Port Priority) In this mode, if the LAN ingress packet contains a VLAN tag, it will then apply the VLAN Priority scheme; otherwise it applies the port-based priority scheme.

When you select **Port** (only) or **VLAN&Port**, the display updates to include **Port Priority** on the bottom line:

```
L2 QoS=Port only  (Off, VLAN, PT, VLAN&Port)
Port Priority: P1:1 P2:2 P3:1 P4:1 ( ◀ ▶ ⬆ )
```

Define Port Priority by using the ◀▶ arrow keys to select the port (**P1, P2, P3, or P4**), and then using the ▲▼ arrow keys to designate a priority from **1 to 4** (with Priority 4 being the highest).

CONFIG: IP → IP Setup: QoS →L3 QoS

When the optional IP Packet Processor card is either **not installed** or **installed but disabled**, and L3 QoS is selected, this menu is **disabled** and appears as follows:

```
L3 QoS=Off
(Fixed at Off) (◄)
```

Otherwise, when the optional IP Packet Processor card is **installed and enabled**, the L3 QoS menu appears as follows:

```
L3 QoS=Off
(Off,Max/Prio,MinMax,DiffServ) (◄)
```

Use the ▲▼ arrow keys to set the L3 QoS operational priority. Press **ENTER**.

Valid settings are:

Setting	Function
Off	QoS disabled.
Max/Prio	(Maximum priority only) Provides multi-level traffic prioritization with the ability to limit maximum traffic per priority class.
MinMax	(Minimum/Maximum priority) Provides a Committed Information Rate (CIR) to each user-defined class of traffic with the ability to allow a higher burstable rate depending on availability.
DiffServ	(DiffServ priority only) Industry-standard method of providing QoS, enabling seamless co-existence in networks that implement DiffServ.

6.2.1.13.3.9 CONFIG: IP → IP Setup: Stats

```
IPstats: Port x In Out (◄▶◄)
Unicasts: 00000003 00000023 Clr:N
```

This screen displays IP traffic statistics for both the **In (Ingress)** and **Out (Egress)** directions. Use the ◀▶ arrow keys to navigate to the proper line, in this order:

First, on the top line – Use the ▲▼ arrow keys to select the bottom-line *IP Stats Type* as **WAN, Ports 1 through 4, HDLC FPGA, or Management**. (“In” and “Out” are column labels for the bottom line parameters and are not selectable.)

Next, on the bottom line – Use the ▲▼ arrow keys to view the desired statistical parameter.

Available statistics are:

IP Stats Type (Use ▲ ▼ to select)	Available Statistics (Use ◀ ▶ to navigate to the bottom line, and then ▲ ▼ to display a desired statistic)		
• WAN	HDLC Frames In / Out		
	Tx Dropped		
	Rx CRC Error		
<ul style="list-style-type: none"> • Port 1 • Port 2 • Port 3 • Port 4 • HDLC FPGA • Management 	Unicasts	511 Octets	*Indicates In only **Indicates Out only
	Broadcasts	1023 Octets	
	Pause	Max Octets	
	Multicasts	Jabber*	
	FCS Error	Oversize*	
	Align Error*	Discards	
	Good Octets	Filtered*	
	Bad Octets*	Collisions**	
	Undersize	Multiple**	
	Fragments*	Single**	
	64 Octets	Deferred**	
	127 Octets	Late**	
255 Octets	Excessive**		

You may clear the IP Statistics accumulators by using the ◀ ▶ arrow keys to move the cursor to **Clr:N**; then, use the ▲ ▼ arrow keys to select **Clr:Y**. Press **ENTER**.

6.2.1.13.3.10 CONFIG: IP → IP Setup: FrmSize

```

2048 Ethernet Frame Size:
Enabled (Dis/Ena)          (◄)
    
```

Use the ▲ ▼ arrow keys to set 2048-byte Ethernet packet sizes as **Enabled** or **Disabled**. Press **ENTER**.

6.2.1.13.4 CONFIG: IP → ANT (Advanced Network Timing)

```
IP Protocols:      SNTP      PTP
                  (◀ ▶)
```

Use the ◀▶ arrow keys to select **SNTP** or **PTP**. Press **ENTER**.

6.2.1.13.4.1 CONFIG: IP → ANT → SNTP (Simple Network Time Protocol)

```
SNTP: Disabled      Time Zone=GMT
Servers: Primary Backup
                  (◀ ▶ ⬇)
```

You may use **Simple Network Time Protocol (SNTP)** to synchronize computer clocks throughout a computer network when the ultimate performance of the full NTP implementation (as per RFC-1305 (Requests for Comment No. 1305: Network Time Protocol, Version 3, Specification, Implementation and Analysis)) is not needed or justified.

Use the ◀▶ arrow keys to navigate between the top line or bottom line operands as needed.

On the top line, use the ◀▶ arrow keys to select **SNTP** or **Time Zone**:

For SNTP – Use the ▲▼ arrow keys to select **SNTP** as **Enabled** or **Disabled**.

- When **Enabled**, SNTP contacts the time server to update the Real-Time Clock (RTC) every hour.
- When **Disabled**, no such notifications take place.

For Time Zone – Use the ▲▼ arrow keys to set your desired time zone:

GMT	GMT+01:00	GMT+02:00	GMT+03:00	GMT+03:30	GMT+04:00
GMT+04:30	GMT+05:00	GMT+05:30	GMT+05:45	GMT+06:00	GMT+06:30
GMT+07:00	GMT+08:00	GMT+09:00	GMT+09:30	GMT+10:00	GMT+10:30
GMT+11:00	GMT+12:00	GMT+13:00	GMT+14:00	GMT-12:00	GMT-11:00
GMT-10:00	GMT-09:00	GMT-08:00	GMT-07:00	GMT-06:00	GMT-05:00
GMT-04:30	GMT-04:00	GMT-03:30	GMT-03:00	GMT-02:30	GMT-02:00
GMT-01:00					

On the bottom line, use the ◀▶ arrow keys to select the **Primary** or **Backup** Server submenu. Press **ENTER** to continue.

Where “##### Time Server” denotes “Primary Time Server” or “Backup Time Server”:

```
##### Time Server: 192.168.001.010
Last Update: Never
                  (◀ ▶ ⬇)
```

On the top line – To edit the selected Time Server’s IP Address, use the ◀▶ arrow keys to select a digit, and then use the ▲▼ arrow keys to change that digit.

On the bottom line – this *read-only* field displays the time and date that the selected server was last updated. The time displays military format (HH:MM:SS); the date displays **DAY-MONTH-YEAR** format in accordance with European convention. As the example shows, this line specifies “**Never**” if no update information exists.

6.2.1.13.4.2 CONFIG: IP → ANT → PTP (Precision Time Protocol)



Sect. K.7.3 Precision Time Protocol (PTP) (Appendix K. ETHERNET NETWORK CONFIGURATION)



All network devices between the Grandmaster and Slave devices must support PTP for sub-microsecond accuracy.

Precision Time Protocol (PTP) is a FAST-activated feature that synchronizes computer clocks throughout a computer network. On LANs, PTP achieves clock accuracy in the sub-microsecond range – much more accurate than what is attainable by NTP (Network Time Protocol) – and it is also used in network applications where GPS is either unaffordable or inaccessible.

```
PTP Feature = Enabled Transport=Multicast
PTP Grandmaster = LAN                (◀ ▶ ↕)
```

On the top line – Use the ◀▶ arrow keys to select **PTP** or **Transport**.

For PTP – Use the ▲▼ arrow keys to select **PTP** as **Enabled** or **Disabled**:

- When **Enabled**, PTP establishes independent Wireless Receiver/Transmitter (WRT) protocol segments – one for LAN, and one for WAN.
- When **Disabled**, by default the availability of the PTP protocol depends on the near-end (e.g., the RNC/BSC) and distant-end (e.g., the BTS) IEEE 1588v2 (PTP) capable network devices in the network.

For Transport – Use the ▲▼ arrow keys to select **Multicast** or **Unicast**. Press **ENT** to continue.

CONFIG: IP → ANT → PTP: Transport=Multicast

On the bottom line – Once you select **Multicast**, use the ◀▶ arrow keys to navigate to **PTP Grandmaster**. Then, use the ▲▼ arrow keys to select the **PTP Grandmaster** as **LAN** or **WAN**:

- The **LAN** port receives messages from the PTP master.
- The **WAN** port receives messages from the PTP master.

Press **ENTER**.

CONFIG: IP → ANT → PTP: Transport=Unicast

```
PTP Unicast Master = 192.012.002.021
Sync Rate = 1 Message every 2 seconds
```

Once you select **Unicast**, use the ◀▶ arrow keys to navigate between the top and bottom line.

On the top line – To edit the PTP Unicast Master IP Address, use the ◀▶ arrow keys to select a digit, and then use the ▲▼ arrow keys to change that digit. Press **ENTER**.

On the bottom line – Use the ▲▼ arrow keys to select the synchronization interval of packets per second for messages sent from the Master to the Slave. Available selections are:

- 1 message per second
- 4 messages per second
- 32 messages per second
- 1 message every 2 seconds
- 8 messages per second
- 64 messages per second
- 2 messages per second
- 16 messages per second



You may use Sync Rate only when the Grandmaster is LAN port and the Transport Mode is Unicast.

6.2.1.13.5 CONFIG: IP → PortMonitor

```
Port Monitor: Enabled          Source=Port 2
Destination=Port 3  Direction=Both  (◀▶)
```

Port monitoring allows a port's ingress and/or egress traffic to be mirrored on another port. This is useful for link monitoring or packet capturing without interrupting live traffic.

Use the ◀▶ arrow keys to move the cursor to the function; then, use the ▲▼ arrow keys to set the function parameter. Press **ENTER**.

Valid selections are:

Function	Setting
Port Monitor	Enabled or Disabled.
Source	WAN, Port 1, Port 2, Port 3, or Port 4.
Destination	Port 1, Port 2, Port 3, or Port 4. (You may not select the active "Source" Port.)
Direction	Ingress, Egress, or Both.

6.2.1.13.6 CONFIG: IP →AccessList



Use this menu to restore SNMP/HTTP access if your own IP Address is inadvertently excluded from the Host Access List while configuring the list through either the SNMP or Web Server (HTTP) interface.

The Host Access List allows you to define which remote clients can connect when the Access List is enabled. Each entry allows a user to specify an IP address and a subnet mask to define a unique class of machines that are allowed access.

Once you define and enable an access list via SNMP or the CDM-625A Web Server interface 'Admin | Access' page, functionality of this menu appears as follows:

```
Host Access List is Enabled
Disable the List: No (N,Y) (◆)
```

Use the ▲▼ arrow keys to select **N** (No) to *maintain* the active Host Access List, or **Y** to *disable* the list. Press **ENTER**.

Once you disable the list, this message appears whenever you select the **CONFIG: IP→AccessList** menu:

```
Host Access List is Disabled
Use HTTP or SNMP to configure the list.
```

6.2.1.13.7 CONFIG: IP → PktP-Enable



You may access this menu only when you have installed the optional IP Packet Processor card.

```
Packet Processor: Enabled (Ena, Dis) (◆)
(Modem will auto-reboot after change!)
```

Use the ▲▼ arrow keys to select the card as **Ena**(bled) or **Dis**(abled):

- The default mode is **Ena**(bled).
- When you **disable** the IP Packet Processor, the card and its accompanying functionality is completely bypassed and the modem reverts to its base modem Layer 2 switch functionality.

Press **ENTER**. The modem will automatically reboot after this configuration change.

6.2.2 SELECT: Test Menu Branch

```
TEST:  Mode  BERT          ( ◀ ▶ )
CnC-APC-Monitor  Uncorrected-BER
```

Use the ◀▶ arrow keys to select a test parameter. Press **ENTER**.

6.2.2.1 SELECT: TEST → Mode

```
Modem Test Mode = Normal      ( ▲ ▼ )
(NORM, Tx-CW, Tx-1/0, IF↓, RF↓, DIG↓, I/O↓)
```

Use the ▲▼ arrow keys to select **Normal** modem operation. Press **ENTER**. Otherwise, select a **Test Mode** from the parameters shown in the parentheses. Valid selections are:

Setting	Function
NORM	(Normal) This clears any test modes or loopbacks, and places the unit back into an operational state.
Tx-CW	(Transmit CW) Use this test mode to force the modulator to transmit a pure carrier (unmodulated).
Tx-Alt-1/0 (Tx-1/0)	(Transmit an alternating 1,0,1,0 pattern) Use this test mode to check the carrier suppression of the Modulator This mode forces the modulator to transmit a carrier modulated with an alternating 1,0,1,0 pattern, at the currently selected symbol rate; this causes two discrete spectral lines to appear, spaced at ± half the symbol rate, about the carrier frequency.
IF-LOOP (IF↓)	(IF Loopback) Use this test mode to invoke an internal IF loop. This is a particularly useful feature, as it permits you to perform a quick diagnostic test without having to disturb external cabling. Furthermore, all of the receive configuration parameters are temporarily changed to match those of the transmit side. All previous values are restored once Normal is again selected. See Figure 5-3 . Starting with Firmware Ver. 1.3.1, IF Loopback now works correctly when Carrier-in-Carrier is enabled.
RF-LOOP (RF↓)	(RF Loopback) Use this test mode to perform a satellite loopback. It is almost identical to the IF loop mode, except that all receive configuration parameters (except Rx Spectrum Invert) are temporarily changed to match those of the transmit side; however, no internal connection is made. All previous values are restored once Normal is again selected.
Dig-Loop (DIG↓)	(Digital Loopback) Use this test mode to invoke a digital loopback, which loops data at the output of the Reed-Solomon encoder on the transmit side and back into the Reed-Solomon decoder on the receive side. This tests the entire interface, transmit baseband circuits, FEC encoder, FEC decoder, and buffer. See Figure 5-3 .
I/O-Loop (IF↓)	(Inward/Outward Loopback) Use this test mode to invoke two distinct loopbacks. The first is the inward loop, which takes data being received from the satellite direction and passes it directly to the modulator. Simultaneously, the outward loop is invoked, whereby data being fed to the transmit data interface is routed directly back out of the receive data interface. See Figure 5-3 .

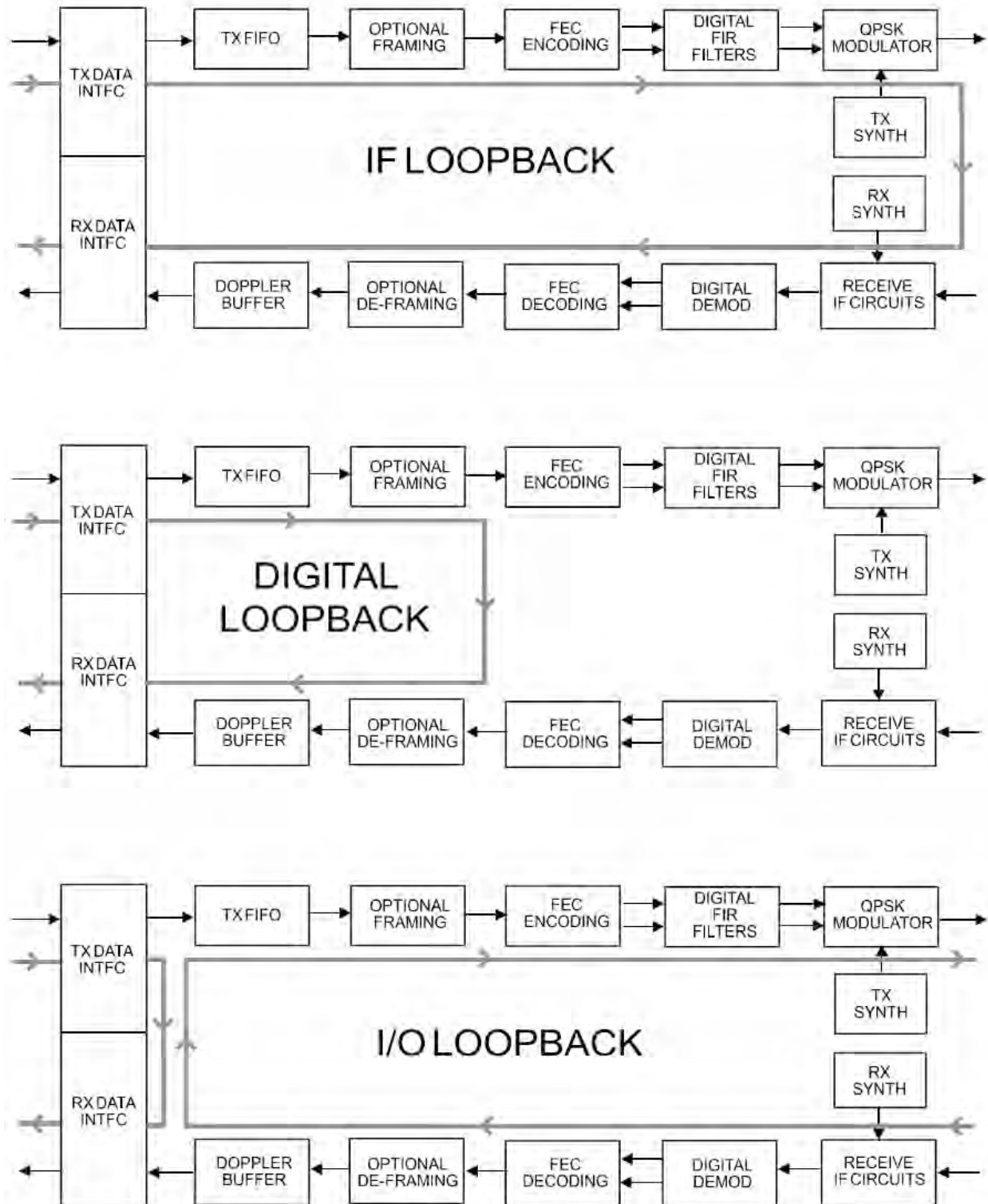

Figure 6-3. Loopback Modes

6.2.2.2 SELECT: TEST → BERT

```
BERT: Config Monitor
                                     ( ◀ ▶ )
```

Use the ◀▶ arrow keys to select **Config** or **Monitor**. Press **ENTER**.

6.2.2.2.1 SELECT: TEST → BERT → Config

```
BERT Tx:Off Pattern=2047 ErrIns=Off
Cnfg Rx:Off Pattern=2047          ( ◀ ▶ ⬇ )
```

Use the ◀▶ arrow keys to select a BERT configuration parameter, and then use the ▲▼ arrow keys to select a parameter setting.

Available settings are:

Option	Setting
Tx/Rx Options	Off or On
ErrIns Options	Off or 10E-3
Pattern Options	Space, Mark, 1:1, 1:2, 63, 511, 2047, 2047R, MIL188, 2 ¹⁵ -1, 2 ²⁰ -1, 2 ²³ -1

6.2.2.2.2 SELECT: TEST → BERT → Monitor

```
BERT Monitor: Errs=0000000 Sync: OK
                BER=0.0E-07 Restart
```

Press **ENTER** to restart the BERT Monitor.

6.2.2.3 SELECT: TEST → CnC-APC-Monitor

```
CNC-APC: BER=N/A Reset FER=N/A Reset
                                     ( ◀ ▶ )
```

The test results provided on this screen are:

Test	Description
BER	Bit Error Rate
FER	Frame Error Rate

To restart either Test, use the ◀▶ arrow keys to select (BER) **Reset** or (FER) **Reset**. Press **ENTER**.

Note that, when CnC-APC is **disabled**, this menu is *inaccessible* and displays the following message:

```
CnC-APC is disabled.          (◀ ▶)
```

6.2.2.4 SELECT: TEST → Uncorrected-BER

```
Uncorrected BER < 5.0E-6
```

In order for a valid test run, you must first configure the modem with Viterbi, VersaFEC CCM, or ULL (Ultra Low Latency) FEC. If the modem is not configured with the required FEC, this screen displays “N/A” in the place of a proper test value on the top line. A configuration advisory follows on the bottom line:

```
Uncorrected BER=N/A  
Requires Viterbi, VersaFEC CCM or ULL (◀ ▶)
```



- Sect. 6.2.1.3.4 CONFIG: Tx → FEC
- CONFIG: Rx → FEC

Additionally, if the demodulator is in unlocked state, this menu is inaccessible and displays the following message:

```
Demodulator is unlocked
```

6.2.3 SELECT: Monitor Menu Branch

```
Monitor: Live-Alarms Stored-Events ACM
Stats Rx-Params RemEbNo AUPC CnC IP (◀ ▶)
```

Use the ◀▶ arrow keys to select a parameter. Press **ENTER**.

6.2.3.1 Monitor: Live-Alarms

```
Live      Unit=None      Net=None
Alarms    Rx=Demod Lock   Tx=No Clock (◄)
```

```
Live      BUC=None
Alarms    LNB=None          (◄)
```

Six alarm types are available between two screens, as shown in the preceding examples. Use the ▲▼ arrow keys to navigate between these *read-only* pages. The **highest** priority alarm currently active for each of the alarm types is as follows:

Alarm Type		Description
Unit	PSU	Power supplies (+5V, +12V, -5V, +18V, -12V) are always monitored by an onboard supervisory IC.
	Tx and Rx Synth	The PLLs in the IF sections are monitored for an unlocked condition.
	Power Cal	Calibration data stored in EEPROM is checked at power-up to verify that the factory calibration has not been corrupted.
	FPGA	Downloads are verified to have been loaded successfully.
	Hi-Stab Freq Ref Module	No PLL Lock – This will suppress the Tx carrier.
Tx (Transmit)	No Clock	Clock activity from the Tx terrestrial source is checked if expected. The modem falls back to the internal SCT clock to drive the modulator if clock activity is absent.
	FIFO Slip	Alarm occurs when the terrestrial clock source differs from the programmed data rate, or may indicate a hardware failure.
	Tx AIS	Alarm Indication Signal (all 1's) is monitored at the Tx terrestrial input if present.
	AUPC Level	A Tx alarm occurs if the power increase limit has been reached when AUPC is enabled.
	Hi-Stab Freq Ref Activity Fault	Reference not present; unit falls back to its internal 10MHz.
	BUC summary alarm	May occur only if ABA is enabled.
	G.703 Loss of Signal	May only occur in Clock Extension Mode.
	PMSI Sym Clock Fail	In a CnC system where a 1:1 or 1:N redundancy switch is in use, this alarm indicates that the PMSI symbol clock is not being detected in the offline unit, suggesting a possible cable fault.

Alarm Type		Description
Rx (Receive)	Demod Lock	Indicates either the demodulator or the following FEC decoder cannot lock to the incoming signal.
	AGC Alarm	Indicates if the demod signal level is out of range.
	Frame Sync	Indicates that the de-framing unit (EDMAC, IBS or IDR) or Reed-Solomon outer decoder cannot synchronize to the data being sent to it by the demod and/or FEC decoder.
	CnC Lock	Indicates that the CnC cancellation algorithm has correctly converged and is successfully tracking.
	Buffer Slip	Occurs when Doppler or Plesiochronous effects cause the Rx data buffer to empty or fill completely, which results in a reset to 50%.
	Rx AIS	Alarm Indication Signal (all 1's) is monitored if present at the Rx satellite input.
	EbNo Alarm	Occurs when the monitored level drops below what was programmed via menus: Config, Rx, EbNo Alarm point.
	Buffer Clock	Indicates that the desired buffer reference is not present, causing the buffer to fall back on Rx satellite timing to clock its output.
Net (Unit Network)	Loss TxFrm	Loss of Tx frame occurs in Drop & Insert operation, when the incoming T1 or E1 frame cannot be found by the modem.
	BER >10E-3	This error rate monitor is enabled for IBS and IDR framing.
	Loss TxMul	Loss of Tx multiframe occurs in E1-CAS D&I operation, when the multiframe marker for CAS signaling data cannot be found.
	Tx Sig AIS	An AIS condition in the signaling positions of an incoming E1-CAS frame is monitored.
	Tx Terr RM	Indicates the presence of the Tx terrestrial remote alarm on the incoming T1 or E1 frame.
	IBS Rx Rem	Indicates the presence of the IBS satellite remote alarm (backward alarm) on the incoming IBS frame from the transmit side of the link.
	IDR Rx BW1-4	Multi-destination backward alarms are the corresponding satellite alarms used by the IDR frame structure.
	IDR Tx BW1-4	Backward alarms 1-4 indicate that the hardware inputs available on the back panel of the modem have triggered, resulting in the generation, by the modem's IDR framer, of a corresponding Tx backward alarm.
BUC		Chapter 10. CDM-625A ODU (TRANSCIVER, BUC, LNC) OPERATIONS
LNB		

6.2.3.2 Monitor: Stored Events

```
Stored Events: Clear-All: No (No, Yes)
#199 FT- Frame Sync 25/10/07 16:25:24
```

An example of a Stored Events screen is shown here. Use the ◀▶ arrow keys to select the '#' character on the bottom line, and then use the ▲▼ arrow keys to scroll up and down through the event log entries. Press **ENTER** or **CLEAR** to return to the previous menu.

The event log can store up to 255 events. When a fault condition occurs, it is time- and date-stamped and put into the log. Similarly, when the fault condition clears, this is also recorded.

The date displays **DAY-MONTH-YEAR** format in accordance with European convention.

Use the ◀▶ arrow keys to select **Clear-All**, and then use the ▲▼ arrow keys to select **Yes** or **No**. Press **ENTER**.

Upon selecting **Clear-All=Yes**, the event log clears and the modem returns you to the previous menu. However, if there already are faults present on the unit at this time, they are re-stamped and new log entries are generated.

6.2.3.3 Monitor: ACM

```
TxModCod=01 QPSK .533 RemoteSNR=04.2dB
RxModCod=02 QPSK .631 LocalSNR=03.5dB
```

This *read-only* screen displays the active **IP-ACM** or **V2-ACM** mode information as follows:

Setting	Function
TxModCod	Displays the Tx ModCod: 00-11 (VersaFEC); 00-35 (VersaFEC 2 Short Block (VF2S)); 00-37 (VersaFEC-2 Long Block (VF2L)).
RemoteSNR	Displays the SNR reported by the remote modem.
RxModCod	Displays the Rx ModCod: 00-11 (VersaFEC); 00-35 (VersaFEC 2 Short Block (VF2S)); 00-37 (VersaFEC-2 Long Block (VF2L)).
LocalSNR	Displays the SNR of the local unit.

When you attempt to access this display when the modem is not in IP-ACM or V2-ACM mode, the following message appears:

```
ACM Parameter is not available.
```

6.2.3.4 Monitor: Statistics

This display shows the statistics data that has been measured and recorded. To enable statistics logging, see **Sect. 6.2.1.10.8**. For statistics logging, you first define a measurement interval (see **CONFIG: Stats**).

The top line displays the statistics log entry number, followed by that log entry's statistical content. You may view up to 255 statistics log entries. Use the ▲▼ arrow keys to scroll backwards or forwards through the entries. **The bottom line** indicates the time and date of the entry shown in **DAY-MONTH-YEAR** format.

Press **ENTER** or **CLEAR** when done viewing to return to the previous menu, or use the ◀▶ arrow keys to select the **Clear-All** option. Then, at the prompt, use the ▲▼ arrow keys to select **Yes** or **No** and press **ENTER** to execute. The statistics buffer will be purged of all entries.

6.2.3.4.1 Monitor: Statistics Examples

In all modes except IP-ACM or V2-ACM:

```
Stats 114: 16.0,16.0,9.0,9.0,16.5,16.5
17/11/14 14:48:06 Clear-All: No (N/Y)
```

The modem calculates and then displays, on the top line from left to right, statistics data as follows:

- **(16.0,16.0)** First, the Eb/No is calculated: The *minimum* Eb/No value observed in the measurement interval is provided first, and then the *average* Eb/No observed value follows. The screen displays 16.0 only if the measured values are ≥ 16.0 dB.
- **(9.0,9.0)** Next, the Transmit Power Level Increase (TPLI) is calculated: The *maximum* TPLI observed in the measurement interval is provided first, and then the *average* TPLI observed value follows.
- **(16.5,16.5)** Finally, the Receive Signal Level (RSL) is calculated (note that both values are negative): The *minimum* value observed in the measurement interval is provided first, and then the *average* RSL observed value follows.



If the demod has lost lock during the measurement interval, the minimum Eb/No will show 'LOSS' rather than indicate a value – however, the average value (while the demod was locked) will still be calculated and shown.

If, on the other hand, the demodulator has been unlocked for the entire measurement interval, the average Eb/No will also show 'Loss' (i.e., the display shows 'Loss,Loss').

In addition, if AUPC is not enabled, the values of maximum and average TPLI will both show '0.0'.

Example 1:

08.0,13.5,2.5,1.8,30.0,25.1 means:

- (08.0) Minimum Eb/No observed in the measurement interval = 8.0 dB
- (13.5) Average Eb/No observed in the measurement interval = 13.5 dB
- (2.5) Maximum TPLI observed in the measurement interval = 2.5 dB
- (1.8) Average TPLI observed in the measurement interval = 1.8 dB
- (30.0) Minimum RSL is observed in the measurement interval = -30.0 dB
- (25.1) Average RSL is observed in the measurement interval = -25.1 dB

Example 2:

Loss,04.5,0.0,0.0,29.0,29.0 means:

- (Loss) There was a loss of demod lock during the measurement interval
- (04.5) Average Eb/No observed in the measurement interval = 4.5 dB
- (0.0) Maximum TPLI observed in the measurement interval = 0 dB
- (0.0) Average TPLI observed in the measurement interval = 0 dB (*which indicates no AUPC activity, or that AUPC is disabled.*)
- (29.0) Minimum RSL is observed in the measurement interval = -29.0 dB
- (29.0) Average RSL is observed in the measurement interval = -29.0 dB

The presentation of statistics information varies slightly when in IP-ACM or V2-ACM mode. **In IP-ACM Mode:**

```
Stats 115: 22.0,22.0,B,0,0,B,21.6,21.6  
17/11/14 12:15:26 Clear-All: No (N/Y)
```

The modem calculates and then displays, on the top line from left to right, statistics data as follows:

- **(22.0,22.0)** First, the SNR is calculated: The *minimum* SNR value observed during the measurement interval is provided first, and then the *average* SNR observed value follows. The screen displays 16.0 only if the measured values are ≥ 16.0 dB.
- **(B)** Next, the Rx ModCod that was current when the entry was logged.
- **(0)** Maximum Rx ModCod, in hex format, during the measurement interval.
- **(0)** Minimum Rx ModCod, in hex format, during the measurement interval.
- **(B)** Number of Rx ModCod changes, in hex format, during the measurement interval.
- **(21.6,21.6)** Finally, the Receive Signal Level (RSL) is calculated (note that both values are negative): The *minimum* value observed in the measurement interval is provided first, and then the *average* RSL observed value follows.

In V2-ACM Mode, the modem calculates and then displays, on the top line from left to right, statistics data as follows:

```
Stats 116: 22.0,22.0,37,37,21.9,21,6
17/11/14 11:18:44 Clear-All: No (N/Y)
```

The modem calculates and then displays, on the top line from left to right, statistics data as follows:

- **(22.0,22.0)** First, the SNR is calculated: The *minimum* SNR value observed in the measurement interval is provided first, and then the *average* SNR observed value follows. The screen displays 16.0 only if the measured values are ≥ 16.0 dB.
- **(37)** Maximum Rx ModCod, in decimal format, during the measurement interval.
- **(37)** Minimum Rx ModCod, in decimal format, during the measurement interval.
- **(22.6, 22.4) (21.6,21.6)** Finally, the Receive Signal Level (RSL) is calculated (note that both values are negative): The *minimum* value observed in the measurement interval is provided first, and then the *average* RSL observed value follows.

6.2.3.5 Monitor: Rx Parameters

```
Rx-Parameters: EbNo=11.4dB ΔF=+011.7kHz
BER=0.0E-9 Buffer=51% RxLevel=-43.5dBm
```

When in IP-ACM or V2-ACM mode:

```
Rx-Parameters: SNR=11.4dB ΔF=+011.7kHz
BER=0.0E-9 Buffer=51% RxLevel=-43.5dBm
```

If the demodulator is locked, then this screen displays the following:

Item	Description
Eb/No	This shows the value of Eb/No calculated by the demodulator. The value referred to here is the energy per information bit (Ebi), divided by the noise spectral density (No).
SNR	(This item replaces “Eb/No” when IP-ACM or V2-ACM mode is active) In ACM, SNR is the preferred metric. Remember that $SNR = Eb/No + 10_{\log}(\text{spectral efficiency})$
ΔF	The frequency offset of the received carrier, in kHz, in increments of 100 Hz.
BER	This is an estimate of the corrected BER.
Buffer	(Buffer fill state) This shows the fill state (in percent), of the receive Buffer. After a reset, it will read 50. A value <50% indicates that the buffer is emptying, and >50% indicates that it is filling.
Rx-Level	A dBm reading indicating the signal level of the desired receive carrier in increments of 0.5 dB

6.2.3.6 Monitor: RemoteEbNo

The appearance of this screen varies depending on the active mode of operation.

For example, when a valid mode of operation is active:

```
Remote EbNo=  Unlock
```

However, when an invalid mode of operation is active (e.g., Quad Drop & Insert):

```
Not applicable without EDMAC/EDMAC2/D&I/  
D&I++/ESC++/FrnQDI/EDMAC3/VFEC-2/IP-ACM
```

6.2.3.7 Monitor: AUPC-Parameters

The presentation of information varies slightly when in IP-ACM or V2-ACM mode.

For all modes except IP-ACM or V2-ACM:

```
AUPC-Params:  Remote EbNo=  6.8 dB  
                Transmit Power Increase= 1.2 dB
```

The top line displays the value of Remote Eb/No of the demodulator at the distant end of the satellite link. The Remote Eb/No displays **Unlock** if the remote Demod is unlocked.

The bottom line shows how much the AUPC system has increased the output power. If AUPC is not enabled, then the value of Tx Power Increase displays as 0.0 dB.

For IP-ACM or V2-ACM modes only:

```
For Eb/No info, see ACM Monitor menu  
                Transmit Power Increase= 1.2 dB
```

The top line message directs you to consult the **Monitor: ACM** menu for the Remote and Local SNR values that is available in place of Remote Eb/No data.

The bottom line shows how much the AUPC system has increased the output power. If AUPC is not enabled, then the value of Tx Power Increase displays as 0.0.

6.2.3.8 Monitor: CnC-Parameters

```
CnC-Params: PwrRatio=-04.1dB PSDR=+01.9dB  
Freq-offset=-123.4kHz Delay=123.4ms
```

When enabled and locked, the screen displays the CnC performance data. This *read-only* display updates once every second.

When CnC-APC is active, the **PwrRatio** and **PSDR** fields will display as 'AUTO'.

6.2.3.9 Monitor: IP Statistics

```
IPstats: Port x      In      Out      (◀ ▶ ⬆)
          Unicasts:  00000003  00000023  Clr:N
```

This screen is identical to and displays the same performance information as the screen shown in Sect. 6.2.1.13.3 CONFIG: IP → Setup → Stats.

6.2.4 SELECT: Info (Information) Menu Branch

```
Info: All ID Mode Tx Rx Clocks EDMAC
      Drop Insert Remote Alarm-Mask Misc
```

These *read-only* screens display the modem's current configuration information without risking inadvertent changes. Use the ◀▶ arrow keys to select a parameter. Press **ENTER**.

After viewing any Info screen except All – Press **ENTER** or **CLEAR** to return to the previous menu.



The display examples that follow are provided for reference only. The information displayed on these screens will differ depending on your modem's active configuration.

6.2.4.1 Info: All

```
All = Start
      (Stop, Start)           (◄◆)
```

Use this menu to scroll through and review configuration settings on a sequential basis. The configuration displays are *read-only* – **no editing is possible**.

To view the configurations – Use the ▲▼ arrow keys to select between **Stop** and **Start**. Press **ENTER** to continue through all the displays.

To discontinue viewing – Press **CLEAR**, use the ▲▼ arrow keys to select **Stop**. Press **ENTER**.

6.2.4.2 Info: ID

```
Modem Circuit ID:
----A TEST MESSAGE TO SHOW CIRCUIT ID---
```

This screen displays the 40-character, user-defined unit label, or Circuit ID string, that was created using the **Utility →Circuit-ID** menu. The Circuit ID also appears in the title bar of compatible web browsers for easy unit identification.

6.2.4.3 Info: Mode

```
Info: Mode: Tx= G.703B:D&I (B8ZS)
        Rx= G.703B:IBS (B8ZS)
```

This screen displays the active operating interface and framing modes that were selected using the **CONFIG: Tx →Mode** and **CONFIG: Rx →Mod** menus.

6.2.4.4 Info: Tx

```
Tx:On 0070.0000MHz PWR=-20.0 TSI=N
Vit+RS:220/200 00064.000 QPSK 7/8 Scrm
```

This screen displays the following information:

Item		Configuration Setting
Top line	Tx Carrier	On, Off, or RTI.
	Tx Frequency	xxxx.xxxx MHz.
	Power	Power Level (dBm).
	TSI	TSI = Tx Spectral Inversion, I=Inverted (on), N=Not inverted (off).
Bottom line	Encoder	FEC type: Viterbi, TCM, Vit+RS, TCM+RS, TPC, LDPC, VFEC, VF2L, VF2S, or None:DE-xxx (where DE-xxx is the Differential Encoder setting DE-Off or DE-On).
	Data Rate	xxxxx.xxx kbps (an asterisk * indicates that the data sense is inverted).
	Modulation	BPSK, QPSK, OQPSK, 8-PSK, 8-QAM, 16-QAM, 8-ARY, 16-ARY, 32-ARY.
	FEC Rate	1/2, 2/3, 3/4, 7/8, 0.95, 5/16, 21/44 or 1/1.
	Scrambler	Scrm, None, or IESS (Turbo Only).

6.2.4.5 Info: Rx

```
Rx:0070.0000MHz 02.0dB +-30 RSI=N
Vit+RS:126/112 01544.000 QPSK 1/2 Scrm
```

This screen displays the following information:

Item		Configuration Setting
Top line	Rx Frequency	xxxx.xxxx MHz.
	Eb/No	12.3 dB (Alarm Point).
	Sweep Range	Up to \pm 32 kHz.
	RSI	RSI = Rx Spectral Inversion, I=Inverted (on), N=Not inverted (off).
Bottom line	Decoder	FEC type: Viterbi, TCM, Vit+RS, TCM+RS, TPC, LDPC, VFEC, VF2L, VF2S, or None:DE-xxx (where DE-xxx is the Differential Encoder setting DE-Off or DE-On).
	Data Rate	xxxxx.xxx kbps (an asterisk * indicates that the data sense is inverted).
	Demodulation	BPSK, QPSK, OQPSK, 8-PSK, 8-QAM, 16-QAM, 8-ARY, 16-ARY, 32-ARY.
	FEC Rate	1/2, 2/3, 3/4, 7/8, 0.95, 5/16, 21/44 or 1/1.
	Descrambler	Scrm, None, or IESS (Turbo Only).

6.2.4.6 Info: Clocks

```
Clocks:Tx=Int(SCT) CEX=RxEnable E1-unbal  
Rx=Int(SCT) Buffer=00016bytes REF=Int10
```

This screen displays information for Tx Clock, G.703 Clock Extension, Rx Clock, Reference, and Buffer.

6.2.4.7 Info: EDMAC

```
EDMAC Function= On  
EDMAC Mode= Master      EDMAC Addr= 0020
```

This screen indicates whether or not EDMAC is enabled. When EDMAC is enabled, it displays the EDMAC Mode and Address.

6.2.4.8 Info: Drop

```
Drop Type=      CH:1  
E1-CCS         TS:01
```

This screen displays the Drop Type and channel allocations.



When in QDI (Quad Drop & Insert) Mode, this screen displays the same information as the CONFIG: D&I → Drop menu.

6.2.4.9 Info: Insert

```
Insert Type=    CH:1  
E1-CCS         TS:01
```

This screen displays the Insert Type and channel allocations. Press **ENTER** or **CLEAR** to return to the previous menu.



When in QDI (Quad Drop & Insert) Mode, this screen displays the same information as the CONFIG: D&I → Drop menu.

6.2.4.10 Info: Remote

```
Remote-Control= Local      Address= 0000
Interface= RS-232         9600 baud   8N1
```

This screen displays if the unit is in *Local*, *Remote* or *Ethernet (IP)* mode; the electrical interface type selected; the unit's address; and the active baud rate.

6.2.4.11 Info: Alarm-Mask

```
Alarms Masked: TxAIS  Terr REF  TxClk  BUC
CnC Buffer AGC RxAIS  Sat  EbNo  LNB  CEX
```

This screen displays *only* the alarm(s) that are currently **masked**. This example shows all available parameters as present and operational. For any alarm that is *not* masked, a blank space assumes that parameter's designated screen position.

6.2.4.12 Info: Misc

```
Miscellaneous: Normal
1:1 Switch=Not connected      Online
```

This screen displays the following information:

Display	Item	Configuration Setting
Top line	Operational Mode	Test Mode or Normal.
Bottom line	1:1 Switch Link Status	Connected or Not Connected.
	Redundancy Status	Offline or Online.

6.2.5 SELECT: Store/Ld (Store/Load) Menu Branch

```
Configuration #2: Load Store (◀▶◆)
AVAILABLE
```

You can store up to 10 modem configurations into an assigned “slot” – 0 through 9. If a configuration slot is available for storage, the bottom line notes the status of that slot as **AVAILABLE**. Otherwise, if the slot contains an existing configuration, the bottom line specifies its storage time in military format (HH:MM:SS); the date displays **DAY-MONTH-YEAR** format in accordance with European convention.

To load (recall) a configuration setting:

- *First*, use the ◀▶ arrow keys to move the cursor to the configuration slot number (Configuration #x) and then use the ▲▼ arrow keys to select a slot number from 0 to 9.
- *Next*, use the ◀▶ arrow keys to select **Load**, and Press **ENTER**. Modem operation then updates as per the configuration settings stored in this slot.

To store (save) a configuration setting:

- *First*, make any desired configuration changes to the modem.
- *Next*, use the ◀▶ arrow keys to move the cursor to the configuration slot number (Configuration #x) and then use the ▲▼ arrow keys to select a slot number from 0 to 9.
- *Finally*, use the ◀▶ arrow keys to select **Store**, and Press **ENTER**.

Once you store a modem configuration into the designated slot, the unit records the time and date and this information appears on the bottom line.

Store Override – When storing into a configuration slot that previously had information saved into the working memory, you must confirm the request as the unit will overwrite the existing information:

```
Configuration #2. Override? No (Y,N) (◆)
14:06:37 26/10/14
```

Use the ▲▼ arrow keys to select the Override choice (Y or N). Press **ENTER**.

6.2.6 SELECT: Utility Menu Branch

```
Utilities: Set-RTC Display-Bright CarrID  
LED Redundancy Circuit-ID Firmware Em
```

Use the ◀▶ arrow keys to select **Set-RTC**, **Display-Bright**, **CarrID**, **LED**, **Redundancy**, **Circuit-ID**, **Firmware**, or **Em**. Press **ENTER**.

6.2.6.1 Utilities: Set-RTC

```
Edit Real-Time Clock:  
Time: 12:01:02 Date:26/10/14 (◀▶◆)
```

To edit the time and date settings of the Real-Time Clock, use the ◀▶ arrow keys to select a digit, and then use the ▲▼ arrow keys to change that digit. Press **ENTER**.



The date displays in **DAY-MONTH-YEAR** format in accordance with European convention.

6.2.6.2 Utilities: Display-Bright

```
Edit Display Brightness:  
100% (◆)
```

Use the ▲▼ arrow keys to adjust the brightness level of the VFD (Vacuum Fluorescent Display). The selectable values are **25%**, **50%**, **75%** or **100%**. Press **ENTER**.

6.2.6.3 Utilities: CarrID



Appendix D. CARRIER ID (DVB-CID METACARRIER®)



BEFORE USING CARRIER ID, BE SURE TO USE THIS MENU TO FIRST CREATE A METACARRIER CUSTOM MESSAGE OF 24 CHARACTERS OR LESS.

```
CarrierID:Off (Off,On) For Tx≥128ksps (◀ ▶ ⬇)
```

Use the ▲▼ arrow keys to select the Carrier ID (MetaCarrier) function as **Off** or **On**. After selecting **On**, the appearance of this menu screen updates as follows:

```
CarrierID:On (Off,On) For Tx≥128ksps (◀ ▶ ⬇)
Latitude Longitude Telephone Message
```

Use the ◀▶ arrow keys to select a parameter. Press **ENTER**.

6.2.6.3.1 Utilities: CarrID → Latitude

```
CarrierID Latitude: 33°25.32'N (◀ ▶ ⬇)
```

Set the Carrier ID Latitudinal Coordinate by using the ◀▶ arrow keys to select an alphanumeric character space. Then, use the ▲▼ arrow keys to change that character. Press **ENTER**.

The unit limits the selection of available alphanumeric characters as follows:

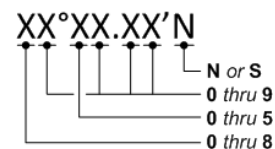

6.2.6.3.2 Utilities: CarrID → Longitude

```
CarrierID Longitude: 111°58.28'W (◀ ▶ ⬇)
```

Set the Carrier ID Longitudinal Coordinate by using the ◀▶ arrow keys to select an alphanumeric character space. Then, use the ▲▼ arrow keys to change that character. Press **ENTER**.

The unit limits the selection of available alphanumeric characters as follows:

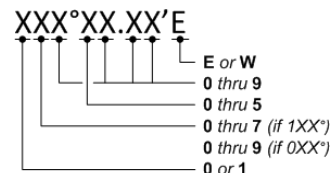

6.2.6.3.3 Utilities: CarrID → Telephone

```
CarrierID Telephone Number:      (◀ ▶ ⬆)
.....+15555555555      .....
```

Edit the Carrier ID unit Telephone Number on the bottom line, by using the ◀▶ arrow keys to select an alphanumeric character space. Then, use the ▲▼ arrow keys to change that character. Press **ENTER**.

The unit limits the Telephone Number to 18 alphanumeric characters or less, and limits the selection of available characters as follows:

[Space] 0-9 and x

6.2.6.3.4 Utilities: CarrID → Message

```
CarrierID Custom Message:      (◀ ▶ ⬆)
.....Custom CarrierID Message.....
```

Compose a MetaCarrier Custom Message on the bottom line by using the ◀▶ arrow keys to select an alphanumeric character space. Then, use the ▲▼ arrow keys to change that character. Press **ENTER**.

You may use all printable ASCII characters, from [Space] (0x20) through tilde ~ (0x7E), to compose a MetaCarrier Custom Message of 24 characters or less.

6.2.6.4 Utilities: LED

```
Front Panel LED Test: Enabled
                      (Enable,Disable)      (⬆)
```

Use the ▲▼ arrow keys to select **Enable**, and then press **ENTER** to execute a test of all of the LEDs on the front panel. Normal operations resume upon completion of the test.

6.2.6.5 Utilities: Redundancy

```
Redundancy:  
Traffic-IP-Addr/Range  1:1  1:N
```

Use the ▲▼ arrow keys to select **Traffic-IP-Addr/Range, 1:1, or 1:N**. Press **ENTER**.

6.2.6.5.1 Utilities: Redundancy → Traffic-IP-Addr/Range

```
Traffic IP address/Range  
192.168.001.001/24      (◀▶◆)
```

To edit the Traffic IP Address and range, when the modem is part of a 1:1 or 1:N redundancy application: First, use the ◀▶ arrow keys to select a digit, and then use the ▲▼ arrow keys to change that digit. Press **ENTER**.

6.2.6.5.2 Utilities: Redundancy → 1:1

```
Press ENTER key to force Unit into  
Standby (1:1 only)
```

For use when the modem is part of a 1:1 redundancy application (e.g., via a CRS-170A L-Band or CRS-180 70/140 MHz 1:1 Redundancy Switch) and this unit is currently *Online*, press **ENTER** to cause the unit to switch to Standby (i.e., go *Offline*).

6.2.6.5.3 Utilities: Redundancy → 1:N

```
1:N Mode:                (use with CAUTION!)  
Disabled (Enable, Disable)  (◆)
```

For use when the unit is part of a 1:N redundant application (e.g., via a CRS-300 1:10 Redundancy Switch). Use the ▲▼ arrow keys to select 1:N Mode operation as **Enable** or **Disable**. Press **ENTER**.



When the unit is connected to a 1:N switch, a red LED located on the rear panel labeled “1:N Active!” indicates that caution is required, as there may be DC voltages and other control signals present on certain pins on the 25-pin ‘Data Interface’ connector.

6.2.6.6 Utilities: Circuit-ID

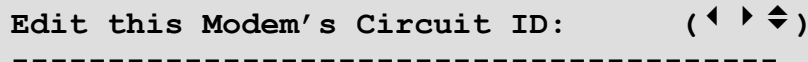

Edit this Modem's Circuit ID: (◀ ▶ ⇄)

Compose a *Circuit ID string* on the bottom line by using the ◀▶ arrow keys to select the alphanumeric character space to edit. Then, use the ▲▼ arrow keys to change that character.

You may use the following characters to compose a Circuit ID string of up to 40 characters in length or a MetaCarrier Custom Message of 24 characters or less:

[Space] () * + - , . / 0-9 and A-Z.

Press **ENTER** once you finish composing the Circuit ID string. As created here, in addition to the front panel VFD, the Circuit ID also appears in the title bar of compatible web browsers for easy unit identification.



Proper composition of the Circuit ID string depends whether the Carrier ID (MetaCarrier) feature operation is turned On or Off (see Sect. 6.2.6.3 Utilities: CarrID):

- 1) With Carrier ID turned On, the first 24 characters of the 40-character Circuit ID are intended for and sent as the MetaCarrier Custom Message. While you must limit your MetaCarrier Custom Message to 24 characters or less, the full 40 characters of the Circuit ID will display on the front panel screen saver (see Sect. 6.1.3.1 Screen Saver).
- 2) With Carrier ID turned Off, the Circuit ID full 40 character length is available for creation of the unit identification label that displays on the front panel VFD screen saver and the Web browser title care.

6.2.6.7 Utilities: Firmware



THESE MENUS ARE FOR DIAGNOSTIC PURPOSES. ONLY CHANGE AN IMAGE IF INSTRUCTED TO DO SO BY A COMTECH EF DATA PRODUCT SUPPORT TECHNICIAN.

```
Firmware Images:
Base-Modem  Packet-Processor  ( ◀ ▶ )
```

Use the ◀▶ arrow keys to select **Base-Modem** or **Packet-Processor**. Press **ENTER**.

6.2.6.7.1 Utilities: Firmware → Base-Modem

```
Firmware Information:
Boot-ROM  Image#1* Image#2  Select  ( ◀ ▶ )
```

Use these submenus to view information about the CDM-625A Base Modem internal firmware. This screen identifies the firmware image that is loaded on startup or reboot of the Base Modem with an asterisk (*). Use the ◀▶ arrow keys to select **Boot-Rom**, **Image#1**, **Image#2**, or **Select**. Press **ENTER**.

6.2.6.7.1.1 Utilities: Firmware → Base-Modem → Boot-ROM, Image#X

```
Bootrom:                DD/MM/YY
FW/12865X                #.#.#
```

The example shown here is for the Bootrom firmware opening screen. Typical for the **Image#1** or **Image#2** screens, you may use the ▲▼ arrow keys to scroll through information for all the constituent firmware blocks that make up the bulk.

This *read-only* information is provided for: firmware type; its number (where 'X' is the revision letter); its build date (in day/month/year format); and its version number (e.g., 1.2.4). Press **ENTER** or **CLEAR** to return to the previous menu.

6.2.6.7.1.2 Utilities: Firmware → Base-Modem → Select

```
Current Active Image is #1
Next Reboot, will use Image: #1  ( ◀ ▶ )
```

The modem can store two complete firmware images. Use this menu to select which image is loaded the next time the unit reboots. The top line shows the current active image while, on the bottom line, you may use the ▲▼ arrow keys to select the other image. Press **ENTER** – the modem will then prompt you to reboot the unit so that the newly-selected image can be loaded upon startup.

6.2.6.7.2 Utilities: Firmware → Packet-Processor

```
Packet Processor Firmware Information:  
Boot-ROM Image#1* Image#2 Select (◀ ▶)
```

This screen identifies, with an asterisk (*), the optional CDM-625A IP Packet Processor internal firmware image that is loaded on startup or reboot of the Base Modem.

Use the ◀▶ arrow keys to select **Boot-Rom**, **Image#1**, **Image#2**, or **Select**. Press **ENTER**.

6.2.6.7.2.1 Utilities: Firmware → Packet-Processor → Boot-ROM, Image#X

```
Bootrom: DD/MM/YY HH:MM:SS  
FW-0000346X #.#.#
```

The example shown here is for the IP Packet Processor Bootrom firmware opening screen. Typical for the **Bootrom**, **Image#1** or **Image#2** screens, *read-only* information is provided for: firmware type; its number (where 'X' is the revision letter); its build date- and time-stamps (in day/month/year and hours/minutes/seconds formats); and its version number (e.g., 1.2.1). Press **ENTER** or **CLEAR** to return to the previous menu.

6.2.6.7.2.2 Utilities: Firmware → Packet-Processor → Select

```
Current Active Image is #1  
Next Reboot, will use Image: #2 (◄)
```

The modem can store two complete firmware images, and you can select which image loads the next time the unit reboots. The top line shows the current active image while, on the bottom line, you may use the ▲▼ arrow keys to select the other image. Press **ENTER** when done – a message will then prompt you to reboot the unit in order for the newly-selected image to load upon startup.

6.2.6.8 Utilities: Em (CDM-600/600L Emulation)

The CDM-625A serves as a 'drop-in' replacement product for CDM-600 and CDM-600L modems. An emulation mode is provided to accomplish this design intent, and is configurable via either this menu or by remote control (remote command **EMU=**).

When emulating a CDM-600 or CDM-600L modem, the CDM-625A opening screen displays the mode of operation, as per this example:

```
Comtech CDM-625A      emulating a CDM-600
TPC installed         Ver 2.2.6
```

Note that, while emulating a CDM-600 or CDM-600L modem, the I/O responses (including that of remote query **EID?**) replicate those of the emulated modem; further, the firmware version number displayed on the opening screen, and the response from the **SWR?** remote query reflects that of the emulated modem's firmware version number.

There are some features that the CDM-625A does *not* support, and as a result are not possible while in CDM-600 or CDM-600L Emulation Modes:

- Sequential FEC coding;
- RS-232 synchronous data interface;
- External ref of 20 MHz;
- BUC leveling;
- Operation below 18 ksps or 18 kbps.

Other parameters have become '*don't care*':

- Impedance;
- External Clock.

6.2.7 SELECT: ODU Menu Branch (Summary Only)



See Chapter 10. CDM-625A ODU (TRANSCIVER, BUC, LNB) OPERATION for complete details about this product-specific menu branch.

```
ODU: BUC:PwrSupply+Ref
      LNB:PwrSupply+Ref FSK-control (◀ ▶)
```

Depending on 70/140 MHz or L-Band operation: Use this menu branch to monitor and control a standalone or redundant Comtech EF Data RF Transceiver (CSAT-5060 or KST-2000A/B) or LPOD BUC, when connected.

6.2.8 SELECT: FAST Menu Branch



The display example as shown here depicts a unit shipped with the Two-channel Audio Drop hardware option installed. If this hardware is not included, 'Audio' does not appear on the bottom line.

```
FAST: Options Demo-Mode CnC
      Baseboard S/N 123456789 HW Rev1.X Audio
```

FAST (Fully Accessible System Topology) allows you to enable new options in the modem. Use the ◀▶ arrow keys to select **Options**, **Demo-Mode**, or **CnC**. Press **ENTER**.

6.2.8.1 FAST: Options

```
FAST options: View Options
               Set Register1 Set Register2 (◀ ▶ ⚡)
```

You can access the **FAST** options via three separate internal EEPROM registers. Each register requires its own **FAST** access code. Use the ◀▶ arrow keys to select **View Options**, **Set Register1**, or **Set Register2**. Press **ENTER**.

6.2.8.1.1 FAST: Options → View Options

```
FAST: View options: 01 (⚡)
               Base 5 Mbps data rate installed
```

Use the ▲▼ arrow keys to scroll through the available options. The modem identifies each selected **FAST** option as "installed" or "not installed".

You must contact Comtech EF Data Product Support to purchase the **FAST** Access Code for the desired option. Available options include:

- ▶ Data Rate
- ▶ Data Rate when configured for TPC/LDPC
- ▶ Data Rate when configured for CnC (DoubleTalk Carrier-in-Carrier)
- ▶ Data Rate when configured for VersaFEC
- ▶ Data Rate when configured for VersaFEC-2 CCM
- ▶ Data Rate when configured for VersaFEC-2 ACM
- ▶ Symbol Rate when configured for IP-ACM or V2-ACM
- ▶ Open Network Framing
- ▶ Modulation:
 - 8-ARY
 - 16-ARY
 - 32-ARY
- ▶ Drop & Insert:
 - 1-port D&I
 - 4-port (Quad) D&I
- ▶ L-Band
- ▶ IP-ACM and V2-ACM (Adaptive Coding Modulation)
- ▶ Data Rate when configured for Header Compression
- ▶ Data Rate when configured for Payload Compression
- ▶ G.703 Clock Extension
- ▶ Advanced QoS (Quality of Service)
- ▶ AES Encryption
- ▶ Fractional CnC (DoubleTalk Carrier-in-Carrier)
- ▶ Advanced Network Timing (PTP – Precision Timing Protocol)
- ▶ Carrier ID
- ▶ CnC Activation

6.2.8.1.2 FAST: Options → Set Register1 or Set Register 2



Chapter 5. FAST ACTIVATION PROCEDURE

```
FAST: Set register#:  ENTER code below  
88888888888888888888888888888888  then [ENTER] (◀▶◆)
```

Where ‘#’ is ‘1’ or ‘2’: Use **FAST: Options → Set Register1** and **Set Register 2** to enable new options in the modem on a per-register basis. It is important to use the appropriate **FAST** access code for the appropriate register.

Contact Comtech EF Data Product Support to order the desired options (see **Sect. 6.2.8.1.1**) – be prepared to provide the Modem Serial Number. The representative will verify the order and provide an invoice and instructions, including a register-specific 20-digit FAST Access Code.

ENTER the **FAST** Access Code that you have obtained from Comtech EF Data *carefully* using the front panel keypad or, alternately, the CDM-625A Web Server (HTTP) Interface:

- *From the CDM-625A front panel* – First, use the ◀▶ arrow keys to select a digit, and then use the ▲▼ arrow keys to change that digit. Compose the code carefully, and then press **ENTER** only when you are ready to execute the upgrade.

The modem responds with “**Configured Successfully**” upon completion of the **FAST** upgrade; the modem then resets to its newly incorporated default configuration. However, if you **ENTER** an invalid code, the modem rejects the entry and the unit prompts you to re-**ENTER** the code as follows:

```
Failed to configure. Re-ENTER code.  
88888888888888888888888888888888  then [ENTER] (◀▶◆)
```

Repeat the FAST access code entry procedure. Should the code entry error persist, contact Comtech EF Data Product Support for further assistance.

- *From the CDM-625A Web Server Interface* – See **Sect. 6.5.4.2.5 Admin | FAST**.

6.2.8.2 FAST: Demo-Mode

```
FAST Options Demo Mode: Off (Off,On) (⬆)
1209600 seconds remaining.
```

FAST Options Demo Mode allows access to **ALL** CDM-625A FAST options for 2592000 seconds (30 calendar days).

On the *top line*, use the ▲▼ arrow keys to select Demo Mode as **Off** or **On**. Press **ENTER**.

The *bottom line* displays the time remaining, in seconds.

Note that:

- The time count decrements only when Demo Mode is turned **On**. You may turn Demo Mode on and off an unlimited number of times until the full 30 calendar days expire.

Upon expiration of the Demo period, the following message displays:

```
FAST Options Demo Mode: Expired (⬆)
0000000 seconds remaining.
```

- Once the timer decrements to 0000000, you may no longer enable FAST Options Demo Mode. Your modem will still function with the purchased FAST enabled features.



If the Demo Mode timer reaches 0000000 while the modem is running a FAST feature that is not a purchased FAST feature, the modem will fall into an invalid state, turn off its carrier, and revert all settings to factory default settings.

6.2.8.3 FAST: CnC

```
FractionalCnC:1-YearCounter=00000000 sec
                90-DayCounter= 0000000 sec
```

Fractional CnC is common in 1:1 or 1:N redundancy systems where the primary modem has a full CnC license, and the backup modem(s) has a Fractional CnC license. A Fractional CnC license allows 90 full calendar days of CnC usage in one calendar year. This lowers the cost of the modem but does not allow for constant, round-the-clock operation.

When you order Fractional CnC Mode, this screen displays the number of seconds remaining for both the 1-year (top line) and 90-day (bottom line) activation timers.

When the counters expire, you will see the following message:

```
Fractional CnC is not installed.
```

As per the previous screen examples, if you do not install Fractional CnC in the CDM-625A, the modem displays a message reflecting this state and provides “time remaining” and “time remaining refill” timers; when you install a Full CnC license, the screen displays **no** timers.

Note that:

- **1-YearCounter** – This is the calendar year counter, in seconds, that resets the 90-Day Counter to 90 full days of CnC usage when it reaches 00000000. This counter continually decrements and accounts for time even when you power **OFF** the modem. Once this timer fully decrements, the **1-YearCounter** resets to 31536000 once again and immediately begins to decrement.



The 1-Year Counter cannot be reset or refilled in the field. Once the timer has run out, your only options are to:

- 1) **Upgrade the modem to a full license.**
- 2) **Wait until “1-YearCounter” reaches 00000000.**

Using Fractional CnC is not a normative mode of operation. To best inform you that your modem is running Fractional CnC (i.e., the “1-YearCounter” counter is actively decrementing), your modem does the following:

- **The front panel RED Unit Status LED will blink on and off.**
- **The modem generates an Event in the Event Log every 12 hours that indicates Fractional CnC is running.**

- **When connected to a 1:1 redundant switch, the modem generates a phantom fault every 12 hours, allowing the Full License CnC modem to return online if its fault has cleared.**
- **90-DayCounter** – This is the amount of time, in seconds, that that the modem can be run in CnC mode. This counter decrements under the following conditions:
 - The modem has a Fractional CnC license;
 - The modem is powered on;
 - The modem's TX is On;
 - The modem is in standalone mode or in 1:1 redundancy configuration and is Online;
 - The modem is NOT in Demo Mode. If the timer reaches 00:00:00:00, the modem will turn its TX Off and the circuit will be down.

Chapter 7. ETHERNET-BASED REMOTE PRODUCT MANAGEMENT

7.1 Overview

The CDM-625A Advanced Satellite Modem base unit is equipped with four RJ-45 10/100 BaseT Ethernet connectors, subject to the following conditions:

- When Dedicated Management is *disabled*, you may use **any port** for Ethernet-based remote product management (monitor and control) purposes.
- When Dedicated Management is enabled, you may use only **that specific port** for remote monitor and control (M&C) purposes.

7.2 Ethernet Management Interface Protocols

The user PC facilitates access to Ethernet-based remote M&C of the CDM-625A through three separately operated protocols:

- **Simple Network Management Protocol (SNMP)** – This requires a user-supplied Network Management System (NMS) and a user-supplied Management Information Base (MIB) File Browser.
- **Telnet Interface** – This requires use of a user-supplied terminal emulation program such as HyperTerminal (for use with the remote control protocol) or PuTTY (for use with the Telnet Command Line Interface), installed on the user PC.
- **CDM-625A HTTP (Web Server) Interface** – This requires a compatible user-supplied web browser such as Internet Explorer, installed on the user PC.

7.3 SNMP Interface

The *Simple Network Management Protocol* (SNMP) is an Internet-standard protocol for managing devices on IP networks. An SNMP-managed network consists of three key components:

- **The managed device** – This includes the CDM-625A Advanced Satellite Modem.
- **The SNMP Agent** – The software that runs on the CDM-625A. The CDM-625A SNMP Agent supports both **SNMPv1** and **SNMPv2c**.
- **The user-supplied Network Management System (NMS)** – The software that runs on the manager.

7.3.1 Management Information Base (MIB) Files

MIB files are used for SNMP remote management of a unique device. A MIB file consists of a tree of nodes called Object Identifiers (OIDs). Each OID provides remote management of a particular function. These MIB files should be compiled in a user-supplied MIB Browser or SNMP Network Monitoring System server.

The following MIB files are associated with the CDM-625A:

MIB File/Name (where * is revision letter)	Description
FW10874-2*.mib ComtechEFData Root MIB file	ComtechEFData MIB file gives the root tree for ALL Comtech EF Data products and consists of only the following OID: Name:comtechEFData Type:MODULE-IDENTITY OID:1.3.6.1.4.1.6247 Full path: iso(1).org(3).dod(6).internet(1).private(4).enterprises(1).comtechEFData(6247) Module: ComtechEFData
FW-0020742*.mib CDM-625A MIB file	MIB file consists of all of the OIDs for management of the modem functions
FW-00020749*.mib CDM-625A Traps MIB file	Trap MIB file is provided for SNMPv1 traps common for modem.
FW-0000345*.mib IP Packet Processor MIB file	MIB file consists of all of the OIDs for management of the optional IP Packet Processor functions.
FW10874-8*.mib CSAT-5060 Transceiver MIB file	MIB file consists of all of the OIDs for management of the CSAT-5060 Transceiver connected to the CDM-625A modem through FSK.
FW10874-9*.mib KST-2000A/B Transceiver MIB file	MIB file consists of all the OIDs for management of the KST-2000A/B Transceiver connected to the CDM-625A modem through FSK.
FW-0020743*.mib DistantEnd CDM-625A MIB file	MIB file consists of a subset of the CDM-625A MIB with all OIDs used manage to a distant-end CDM-625A. SNMP "gets" and "sets" are sent to the local CDM-625A and EDMAC3 is used to communicate efficiently with the distant end modem.

7.3.2 SNMP Community Strings



CAUTION – In SNMP v1/v2c, the SNMP Community String is sent unencrypted in the SNMP packets. Caution must be taken by the network administrator to ensure that SNMP packets travel only over a secure and private network if security is a concern.

The CDM-625A uses Community Strings as a password scheme that provides authentication before gaining access to the modem agent's MIBs. They are used to authenticate users and determine access privileges to the SNMP agent.

Type the SNMP Community String into the user-supplied MIB Browser or Network Node Management software.

The user defines three Community Strings for SNMP access:

- **Read Community** default = public
- **Write Community** default = private
- **Trap Community** default = comtech



For proper SNMP operation, the CDM-625A MIB files must be used with the associated version of the CDM-625A Advanced Satellite Modem M&C. Read the CDM-625A FW Release Notes for information on the required FW/SW compatibility.

7.3.3 SNMP Traps



The modem must be in Ethernet remote mode for the traps to work. You must also properly assign/configure the Trap IP Address.

The CDM-625A supports both **SNMPv1** traps and **SNMPv2** notifications. The modem has the ability to send out SNMP traps when certain events occur and clear in the modem, including unit faults, Tx faults, Rx faults, and ODU faults.

You only need to compile the “**Traps**” file if you intend to use **SNMPv1** traps. You may configure which style of traps the modem sends by using the CDM625ASNMPTrapVersion OID.

The CDM-625A supports the following MIB2 v1 traps / v2 notifications:

MIB2 SNMPv1 trap: Authentication Failure	5
MIB2 SNMPv2 notifications: Authentication Failure	1.3.6.1.6.3.1.1.5.5

The CDM-625A supports the following Alarms and Faults SNMPv1 traps / SNMPv2 notifications:

Alarms and Faults SNMPv1 traps	
cdm625aUnitAlarmV1	6247641
cdm625aTxTrafficAlarmV1	6247642
cdm625aRxTrafficAlarmV1	6247643
cdm625aOpenNetworkAlarmV1	6247644
cdm625aBUCAAlarmV1	6247645
cdm625aLNBAAlarmV1	6247646
cdm625aRedundancyStateTrapV1	6247647
cdm625aFractionalCnCTrapV1	6247647

Alarms and Faults SNMPv2 notifications:	
cdm625aUnitAlarm	1.3.6.1.4.1.6247.80.2.0.1
cdm625aTxTrafficAlarm	1.3.6.1.4.1.6247.80.2.0.2
cdm625aRxTrafficAlarm	1.3.6.1.4.1.6247.80.2.0.3
cdm625aOpenNetworkAlarm	1.3.6.1.4.1.6247.80.2.0.4
cdm625aBUCAAlarm	1.3.6.1.4.1.6247.80.2.0.5
cdm625aLNBAAlarm	1.3.6.1.4.1.6247.80.2.0.6
cdm625aRedundancyStateTrap	1.3.6.1.4.1.6247.80.2.0.7
cdm625aFractionalCnCTrap	1.3.6.1.4.1.6247.80.2.0.8

7.4 Telnet Interface



- Chapter 8. SERIAL-BASED REMOTE PRODUCT MANAGEMENT
- Chapter 9. TELNET COMMAND-LINE INTERFACE (CLI) OPERATION

Comtech EF Data provides a Telnet interface for the purpose of equipment monitor and control (M&C) using either the standard remote control protocol or, when the optional IP Packet Processor is **installed** and **Enabled**, the Telnet Command Line Interface (CLI).

7.4.1 Using the Telnet Interface for Standard Remote Control Protocol

Do these steps to use Windows Command-line to access the CDM-625A Telnet Interface:

1. Click **[Start]** on the Windows taskbar, and then click the **Run...** icon (or, depending on Windows OS versions prior to Windows 95, click the **MS-DOS Prompt** icon from the **Main Menu**).
2. Next, open a **Command-line window...**
 - For Windows 95 or Windows 98, type “**command**” (or, for any Windows OS versions later than Windows 98, type “**cmd**” or “**command**”):
 - Alternately, from **[Start]**, select **All Programs > Accessories > Command Prompt**.

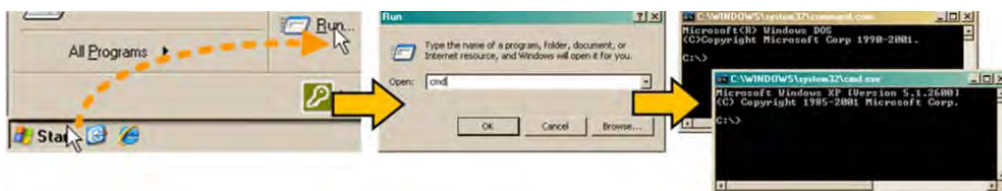

3. From the Command-line prompt (c:\>), type “**telnet xxx.xxx.xxx.xxx**” (where ‘**xxx.xxx.xxx.xxx**’ is the modem’s Ethernet Traffic/Management IP Address).
4. Access requires login at the **Administrator** and **Read/Write** User Access Levels. Once you log in as the Administrator, you may issue remote commands and queries over the CDM-625A Telnet Interface, as this example shows:

```

c:\ Telnet 192.168.1.2
COMTECH EF DATA CDM-625A TELNET INTERFACE
You must have an account to use this interface.
Please see your administrator.
Enter name: comtech
Enter password: comtech
Name and Password accepted. Please review your modem manual for command syntax.
Telnet to port 107 for TELNET CLI.
Note: Requires Packet Processor enabled and Remote set to Ethernet.

<Q=Quit> Telnet--><0/TFQ?
>0000/TFQ=0070.0000

<Q=Quit> Telnet-->
```

7.4.1.1 Using HyperTerminal for Telnet Remote Control Operation

There is a disadvantage when using Windows Command-line as a Telnet client with the serial-based Remote Control protocol. Since Command-line cannot translate a '\r' (i.e., carriage return or "CR") to a '\r\n' (i.e., CR+line feed "LF") for the messages coming from Telnet Server, any multi-line Target-to-Controller response (e.g., the response to the FRW? query) will be displayed as one line, with the latter lines overwriting the previous lines.

You may use the HyperTerminal terminal emulation program, configured as a Telnet client, to view the full response messages. Do these steps to configure HyperTerminal:

1. Be sure to properly define the "Connect To" Telnet connection properties (**File** → **Properties**), as shown below at the near right:

- a) Enter the CDM-625A's Traffic/Management IP Address as the **Host Address** (e.g., 192.168.1.1).
- b) Enter TCP Port **23** as the **Port number**.
- c) Set **Connect using** to **TCP/IP (Winsock)** instead of COM1 or COM2.

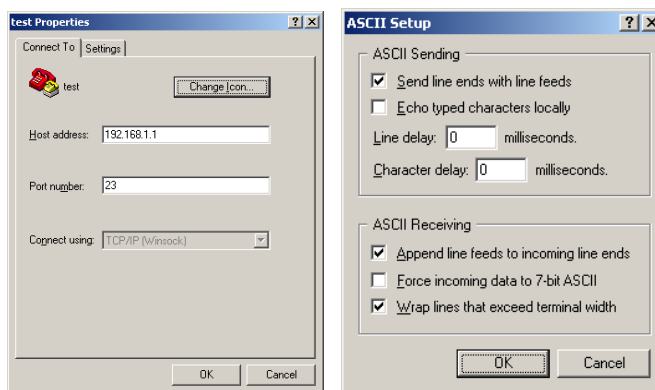

2. For **ASCII Setup** (**File** → **Properties** → **Settings** → **ASCII Setup**), as shown above at the far right:

- a) Check the "Send line ends with line feeds" option in the *ASCII Sending* section.
- b) Check the "Append line feeds to incoming line ends" option in the *ASCII Receiving* section.

Examples of login and remote command/query execution, when using HyperTerminal as the interface, appear as follows:

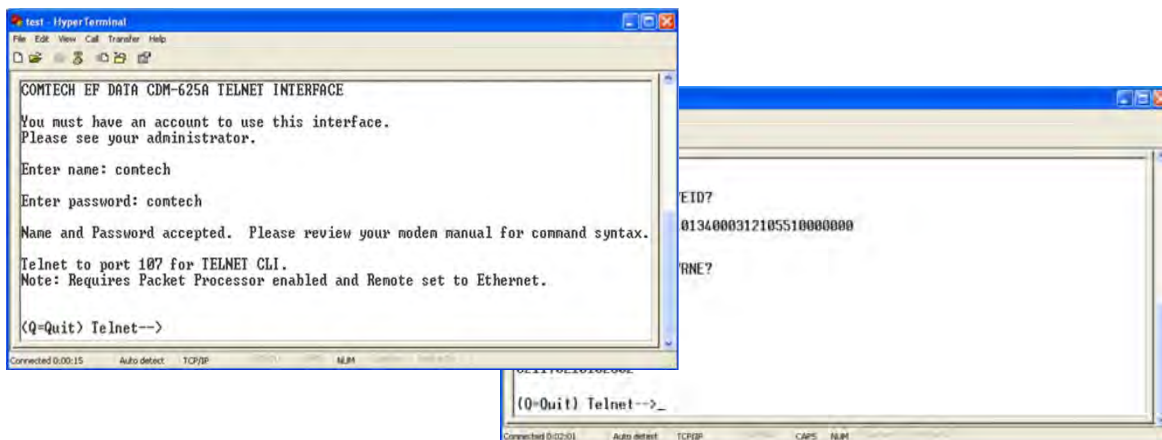

7.4.2 Using the Telnet Interface for Telnet Command Line Interface (CLI) Operation

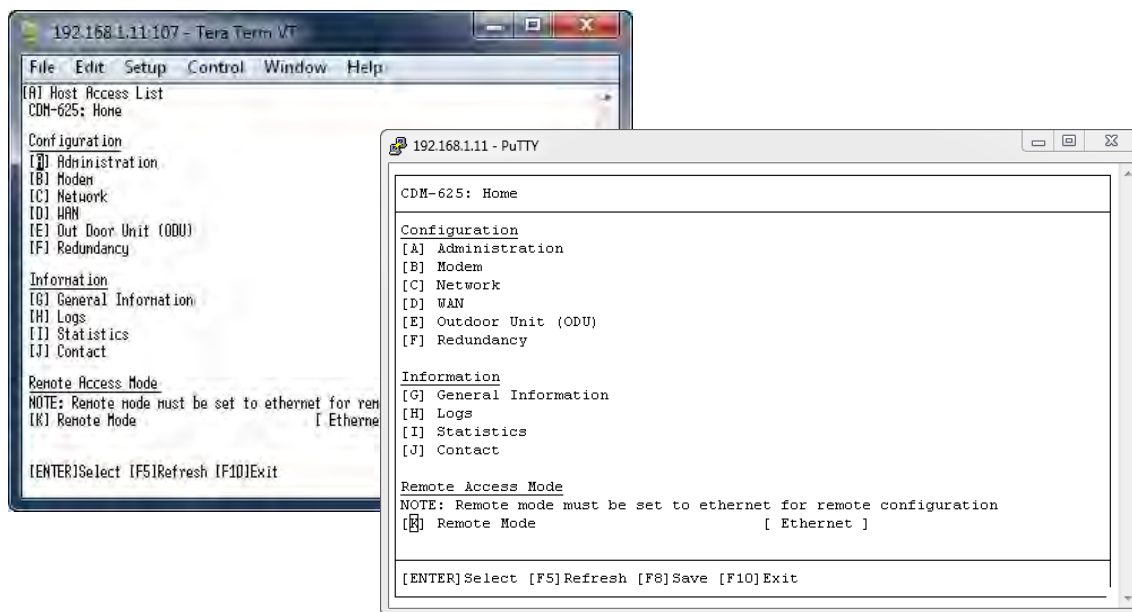

(LEFT) TeraTerm CLI Example
(RIGHT) PuTTY CLI Example

Figure 7-1. CDM-625A Telnet Command Line Interface (CLI)



- 1) The CDM-625A Telnet Command Line Interface (CLI) is accessible only when you install and enable the optional IP Packet Processor.
- 2) The CDM-625A Telnet CLI uses Telnet TCP Port 107. Be sure to specify this port when configuring your terminal emulator for CLI operation.
- 3) The HyperTerminal terminal emulator, while compatible for use with remote control operations, is not supported or recommended for CDM-625A Telnet CLI operation. Instead, for best results Comtech EF Data recommends PuTTY or Tera Term or as the preferred terminal emulators (Figure 7-1).

7.5 HTTP (Web Server) Interface

A user-supplied Web browser allows the full monitor and control (M&C) of the CDM-625A from its HTTP Interface. The CDM-625A's embedded web application is designed for, and works best with, Microsoft's Internet Explorer Version 9.0 or higher. Comtech EF Data does not recommend setting your browser to IE7 Compatibility Mode.

7.5.1 User Login

Type the CDM-625A's Traffic/Management IP Address (shown here as *http://xxx.xxx.xxx.xxx*) into the **Address** area of the user PC Web browser:



The Login window will appear, similar to the example shown here, opens. Enter the assigned **User name** and **Password**. The HTTP Interface default user names and passwords are as follows:

- **Admin** comtech/comtech
- **Read/Write** opcenter/1234
- **Read Only** monitor/1234

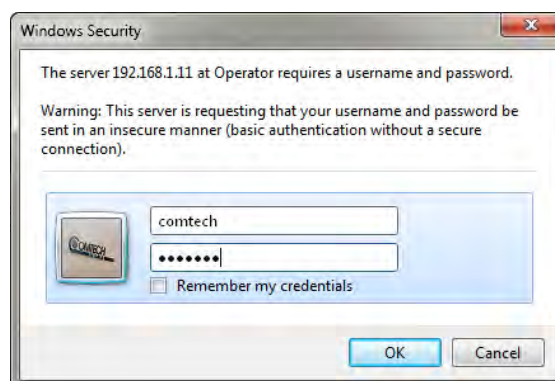

HTTP Login User Access Levels are further defined as follows:

HTTP Login User Access Level		
Admin User	Read/Write User	Read Only User
<u>Full Access to all web pages.</u>	<u>No Access</u> to Admin or IP Packet Processor-related web pages.	<u>No Access</u> to Admin or IP Packet Processor-related web pages.
	Full Access for all other web pages	View Only Access for all other web pages.

Type the User Name and Password, and then click **[OK]**.

Once the valid User Name and Password is accepted, you will see the CDM-625A HTTP Interface "splash" page, as per the following example (note that the Base Modem and optional IP Packet Processor *Firmware Versions* listed here are subject to change):

To properly access the CDM-625A HTTP Interface, you must first set remote control access for the unit to **Ethernet mode**. If you attempt to log in to the HTTP Interface and



remote control for the CDM-625A has not been set to **Ethernet mode**, access is blocked and the following error message displays in the browser window:



Click [**Enable Ethernet Mode**] to switch over from your current mode to **Ethernet Mode**.

Alternately, from the CDM-625A front panel, use the ◀ ▶ arrow keys to navigate to, and the ▲ ▼ arrow keys to edit, the remote control configuration menu (press **ENTER** when done):

SELECT: Configuration → Remote → Remote Control=Ethernet

7.5.2 HTTP Interface – Operational Features

7.5.2.1 Navigation

This interface features navigation tabs located at the top of each page. After you click a navigation tab, you may click an available primary page tab. In turn, any nested tabs appear for further selection.



This manual uses a naming format for all pages to indicate the depth of navigation needed to view the subject page: “**Top Level Tab | Primary Page Tab | Nested Tab**”.

For example: “**Admin | Firmware | Base Modem**” is interpreted to mean “*first* click the top-level ‘Admin’ navigation tab; *then*, click the ‘Firmware’ primary page tab; *finally*, click the nested ‘Base Modem’ tab.”

7.5.2.2 Page Sections

Each page features one or more sections. The title at the upper-left corner of each page or page section describes its operational features. Each section can feature editable fields, action buttons, and read-only displays for a specific function.



This manual explains the purpose and operation for each Web page on a **per-page, per-section** basis.

7.5.2.3 Action Buttons

Action buttons are important in the HTTP Interface.

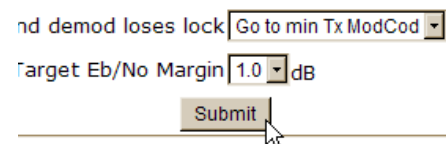

Click an action button to do one of these tasks:

- Refresh the page with current data.
- Reset changed parameters to remove **unsaved** changes.
- Submit (permanently save) changes.



If you edit a field, make sure to click the action button before you leave the page. If you go to another page without first clicking the action button, your changes are not saved.

7.5.2.4 Drop-down Lists

A drop-down list lets you choose from a list of selections. Left-click the drop-down button to open the list. Then, left-click on an item to select that choice.

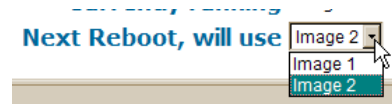

7.5.2.5 Text or Data Entry

Text boxes let you type data into a field. An action button may be associated with a single text box, or a group of text boxes.

For any text box, left-click anywhere inside the box, type the desired information into that field, and be sure to press **[ENTER]** when done.

Click the related action button to save the data.

Item Account Access Info

Read Only Name	<input type="text" value="mon"/>
Read/Write Name	<input type="text" value="opcenter"/>
Admin Name	<input type="text" value="comtech"/>



If you edit any field, make sure to click the action button before you leave the page. If you go to another page without first clicking the action button, your changes are not saved.

7.5.3 HTTP Interface – Menu Tree



The CDM-625A HTTP Interface pages in this diagram that are marked with an asterisk (*) are selectable/operational only when you activate the optional FAST feature, or when you install and enable the optional IP Packet Processor card and log in with Admin access privileges. See Sect. 7.5.3.1 for detailed information about this conditional access.

Any page marked with double asterisks (**) is functional only when an auxiliary product such as a BUC or LNB is installed.

The menu tree diagram (Figure 7-2) lists the features available through the CDM-625A HTTP (Web Server) Interface. This interface features six navigation tabs (shown in blue). Primary page tabs (green) and nested page tabs (yellow) provide access to individual Web pages. Click any navigation tab to continue.

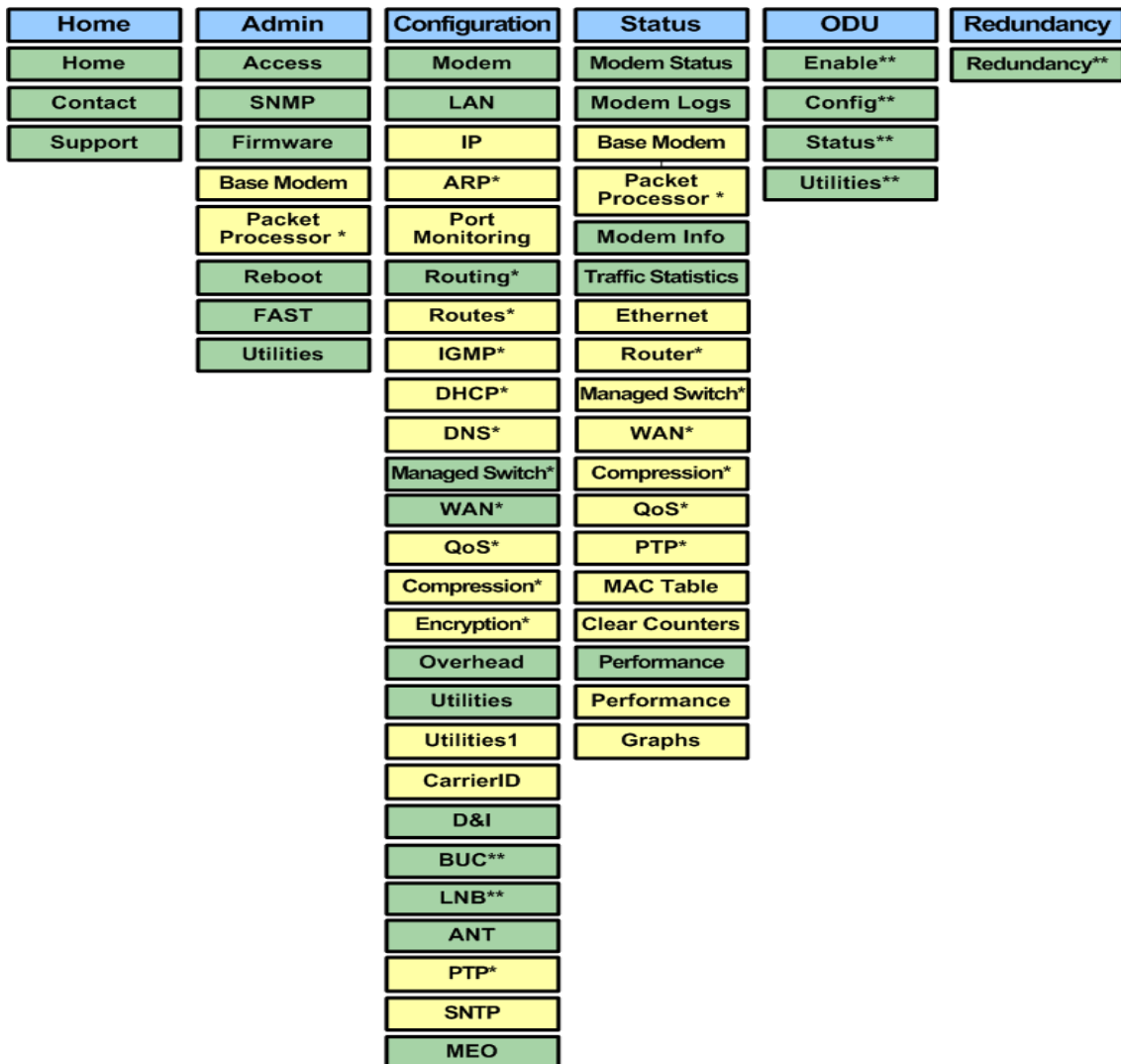

Figure 7-2. CDM-625A HTTP (Web Server) Interface Menu Tree (FW Ver. 1.4.1)

7.5.3.1 Conditional Access to IP Packet Processor Pages



Carefully review the information in this section.

There are a significant number of pages in the CDM-625A HTTP Interface that address operation of the CDM-625A once it is equipped with the optional IP Packet Processor card. These pages are accessible only when you **install and enable** the optional IP Packet Processor card.

As specified in **Sect. 7.5.1**, access to these pages is further restricted to “Admin” (administrative) users **only**. If a user with “Read/Write” or “Read Only” user access privileges attempts to select any IP Packet Processor-specific page, access to that page is prohibited and either of the following error messages may display in the browser window:

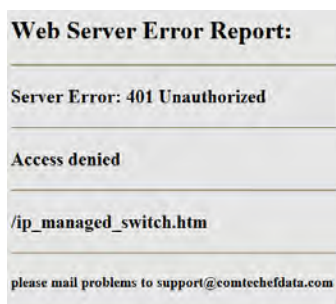

You do not have security privilege to access this area

Once logged in, if the Admin user attempts to access any IP Packet Processor-specific page when the optional IP Packet Processor card is **not installed**, the following message displays:

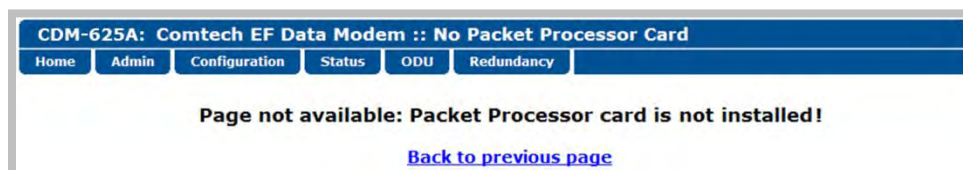

Click **[Back to previous page]** to resume use of the interface.

If the Admin user attempts to access these pages when the optional IP Packet Processor card is **installed** but card operation is **disabled**, the following message displays:



Click **[Back to previous page]** to continue any other available operations, or go to the Packet Processor drop-down list (in the Network Configuration section of the **'Configuration | LAN | IP'** page) to select its operation as **Enabled** (the modem will automatically reboot).

The CDM-625A HTTP Interface menu tree diagram (**Figure 7-2**) indicates those primary and nested IP Packet Processor pages having conditional access and operation with an asterisk (*). Further, each interface page subsection (under **Sect. 7.5.4 Web Server Page Descriptions**) governed by such restrictions contains an advisory note similar to this example:



These pages are accessible only to Admin users and when you install and enable the optional IP Packet Processor card. See Sect. 7.5.3.1 for complete details about using these conditional access pages.

7.5.4 Web Server Page Descriptions



Access to and availability of certain CDM-625A HTTP Interface pages are dependent upon the options purchased for operation (e.g., the IP Packet Processor card) as well as the detected presence of auxiliary equipment (e.g., Block Up Converters, Low Noise Block Down Converters, Redundancy Switches, etc.), as installed and configured for use with the CDM-625A. Any such operational restrictions are noted in the subsections that follow through the remainder of this chapter.

7.5.4.1 Home Page

Use this page to identify the product and its current operating firmware version. Click the **Home** navigation tab and/or the nested page tab to return to this page from anywhere in the HTTP Interface.

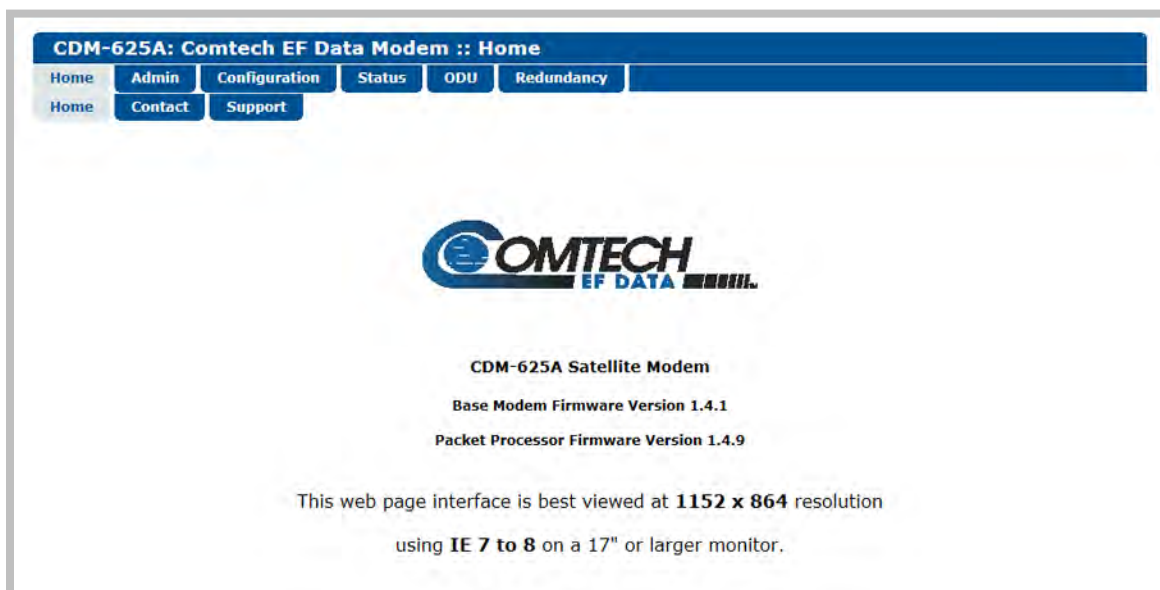

Figure 7-3. CDM-625A Satellite Modem Home page

7.5.4.1.1 Home | Contact / Home | Support

For all product support, please call:

+1.240.243.1880

+1.866.472.3963 (toll free USA)

7.5.4.2 Admin Pages

Use these pages to set up user access, manage the firmware load preferences, and activate FAST features.



The Admin pages are available only to users who have logged in using the Administrator Name and Password.

Click the **Access**, **SNMP**, **Firmware**, **Reboot**, **FAST**, or **Utilities** tab to continue.

7.5.4.2.1 Admin | Access

Figure 7-4. Admin | Access page

System Account Access Information

- **Read Only, Read/Write, Admin Names and Passwords** – The factory defaults for these user names and passwords are:

Description	Factory Default User Name / Password	Typical Parameters
Read Only	monitor / 1234	Name and Password fields can be any alphanumeric combination with a maximum length of 10 characters.
Read/Write	opcenter / 1234	
Admin	comtech / comtech	

- **SMTP Server** – Specify the mail server IP Address from where e-mail may be sent.
- **SMTP Domain Name / Destination** – The Administrator can assign the SMTP Domain Name and Destination.
 - **SMTP Domain Name** – Specify the domain of the e-mail server (usually found to the right of the '@' symbol in an e-mail address).
 - **SMTP Domain Destination** – Specify the e-mail recipient name (usually found to the left of the '@' symbol in an e-mail address).

Host Access List

- **IP (#) / Mask** – The Host Access List allows a user to define which remote clients can connect when the Access List is **Enabled**. Each entry allows a user to specify an IP Address and a subnet mask to define a unique class of machines that are allowed access.

For example, if a user wanted to grant access to a PC with an IP Address of 10.10.10.1 and any PC on a subnet of 192.168.10.XXX, and then the Access List would be defined as:

IP 1 / Mask – 10.10.10.1/32
IP 2 / Mask – 192.168.10.0/24



The check box before the IP (#) / Mask must be checked in order for that list entry to take effect.

- **Access List** – The Access List allows a user to grant access via HTTP and SNMP to a defined list of client machines.

Use the drop-down to select **Enable** or **Disable**. If **Disable** is selected, then any client machine will be able to connect via HTTP and SNMP.

Click **[Submit Admin]** to save.

RADIUS (Remote Authentication Dial In User Service)



Appendix T. CDM-625A RADIUS CLIENT



RADIUS operation is available only when the CDM-625A operating mode is set to IP or IP-ACM.

- **RADIUS Client** – Use the drop-down list to set RADIUS operation as **Enabled** or **Disabled**.
- **Server Password Type** – Use the drop-down list to select the authentication protocol as PAP (Password Authentication Protocol) or CHAP (Challenge-Handshake Authentication Protocol).
- **Primary / Secondary Server IP Address** – Enter the pertinent Server IP Addresses in the form **xxx.xxx.xxx.xxx**.
- **Server Shared Secret** – *Carefully* enter the word to be used (64 characters maximum) as the "shared secret" between the RADIUS Client Server and the networked device (CDM-625A). The interface conceals this entry for security purposes.
- **Server Port** – Enter a valid port number from **1** to **65535** (the default is **1812**).

Click [**Submit Radius**] to save.

RADIUS Log

This scrollable window displays the last 20 users who have logged onto the RADIUS server.

7.5.4.2.2 Admin | SNMP



- Chapter 6. FRONT PANEL OPERATION
- Sect. 7.3 SNMP INTERFACE

The Administrator must use this page to set and return administration information for the CDM-625A SNMP (Simple Network Management Protocol) feature.

Figure 7-5. Admin | SNMP page

SNMP

- **Simple Network Management** – Use the drop-down list to select as **Disabled** or **Enabled**.
- **Enable Authentication Trap** – Use the drop-down list to select as **Disable** or **Enable**.
- Assign up to two **SNMP Trap IP Addresses** in the form xxx.xxx.xxx.xxx.
- **Trap Version** – Use the drop-down list to select **SNMPv1** or **SNMPv2**.
- **SNMP Read/Write/Trap Community Strings, SNMP Contact/Name/Location** – Create or edit these alphanumeric text strings as follows:

Setting	Factory Default	Typical Parameters
SNMP Read Community String	public	The Read, Write, and Trap Community Strings can be any alphanumeric combination with a maximum length of 4 to 15 characters.
SNMP Write Community String	private	
SNMP Trap Community String	comtech	
SNMP Contact	N/A	The SNMP Contact, Name, and Location strings can be any alphanumeric combination with a maximum length of 0 to 20 characters.
SNMP Name	N/A	
SNMP Location	N/A	

- **CDM-625 MIB Compatibility** – Use the drop-down list to select as **Disabled** or **Enabled**.

This feature is available only when the optional IP Packet Processor is **installed and enabled**. When enabled, you may use CDM-625 MIBs to monitor and control features that are common to both the CDM-625 and CDM-625A/AL modems.

- **SNMP Access Level** – Use the drop-down list to select **Read and Write** (default) or **Read Only**.

Click **[Submit Admin]** to save.

7.5.4.2.3 Admin | Firmware Pages



Chapter 4. UPDATING FIRMWARE

Click the **Base Modem** tab, or, when the optional IP Packet Processor card is **installed**, the **Packet Processor** tab to continue.

7.5.4.2.3.1 Admin | Firmware | Base Modem

Use this page to view the scrollable, **read-only** status windows that provide information about the basic unit's two loaded and operational firmware images.

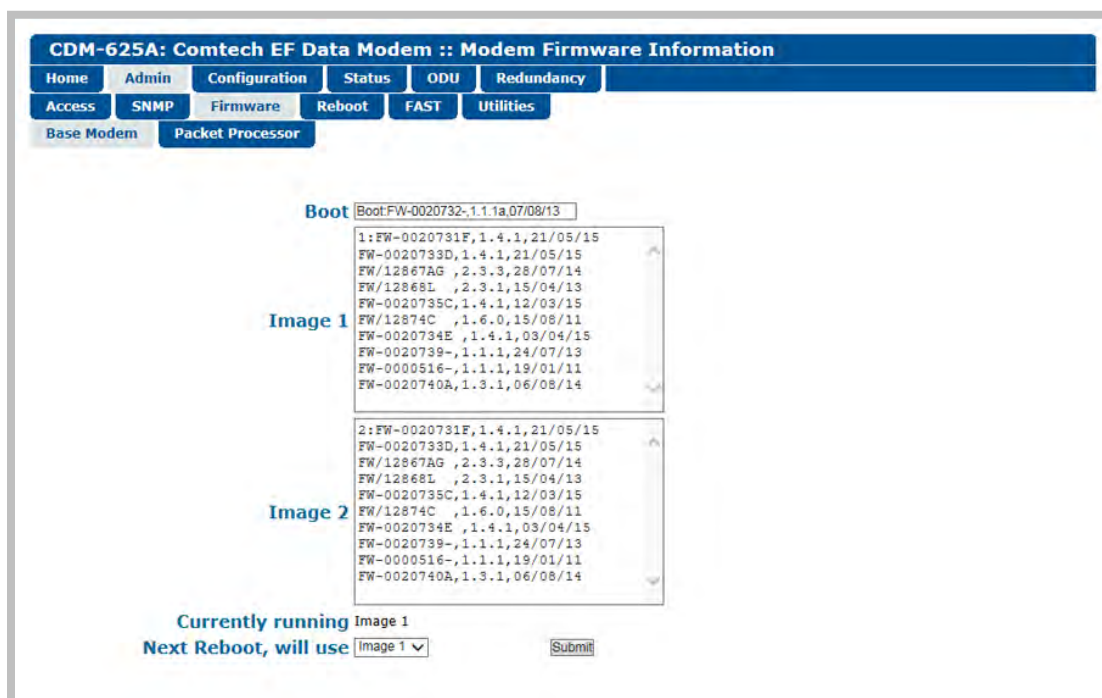

Figure 7-6. Admin | Firmware | Base Modem page

Boot

This window identifies the firmware number, version, and release date that is loaded upon power-up/boot up of the unit.

Image 1 / Image 2

These scrollable windows identify the Firmware numbers, versions, and release dates that comprise the aggregate image load.

Currently Running (*read-only*)

The current running image is identified here.

Next Reboot, will use

Use the drop-down list to select **Image 1** or **Image 2** as the image to use upon next reboot, and then click **[Submit]** to save this selection.

7.5.4.2.3.2 Admin | Firmware | Packet Processor



This nested page is accessible only to Admin users and when you **install** and **enable** the optional IP Packet Processor card. See Sect. 7.5.3.1 for complete details about using conditional access pages.

Use this page to view the status window for the optional IP Packet Processor's currently loaded firmware, and to set the firmware load preference for the IP Packet Processor upon power-up/reboot of the unit.

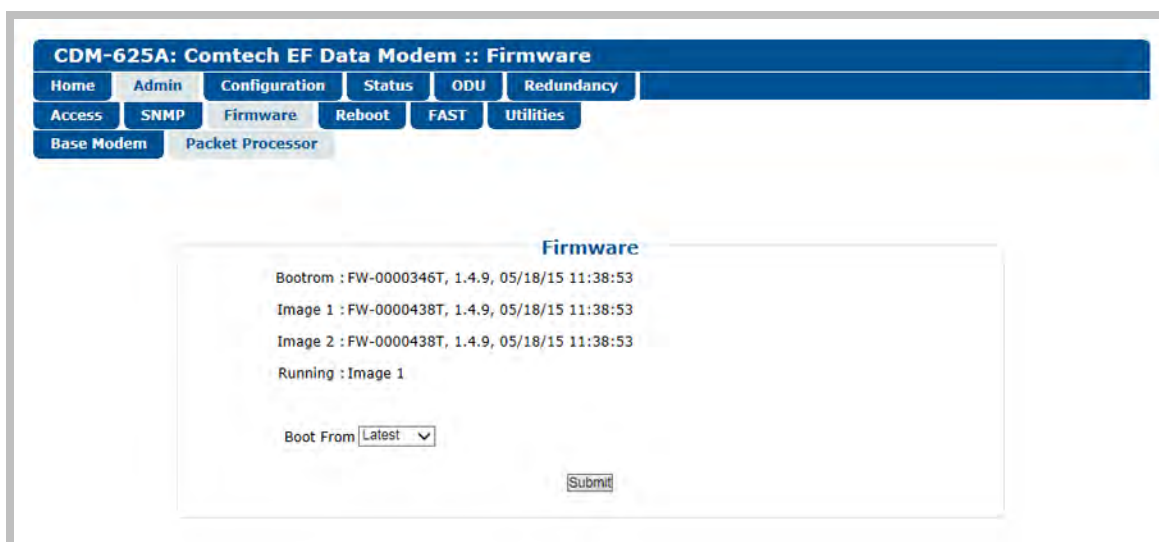

Figure 7-7. Admin | Firmware | Packet Processor page

Firmware

- (**Read-only**) The IP Packet Processor's *Bootrom*, *Image 1*, *Image 2*, and current *Running* image are identified here.
- **Boot From** – Use the drop-down list to boot the IP Packet Processor from **Latest**, **Image 1**, or **Image 2**, and then click **[Submit]** to save this selection.

7.5.4.2.4 Admin | Reboot

Use this page to perform a soft reboot of the CDM-625A using the *current, active firmware Image* as selected on the 'Admin | Firmware | Base Modem' page (Sect. 7.5.4.2.3.1) and/or the 'Admin | Firmware | Packet Processor' page (Sect. 7.5.4.2.3.2).

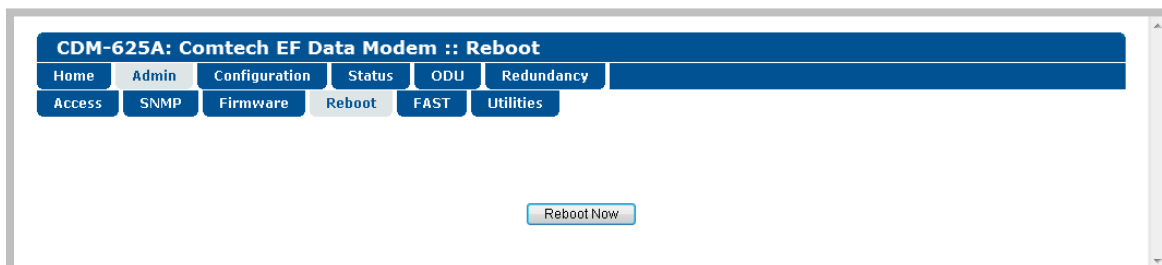
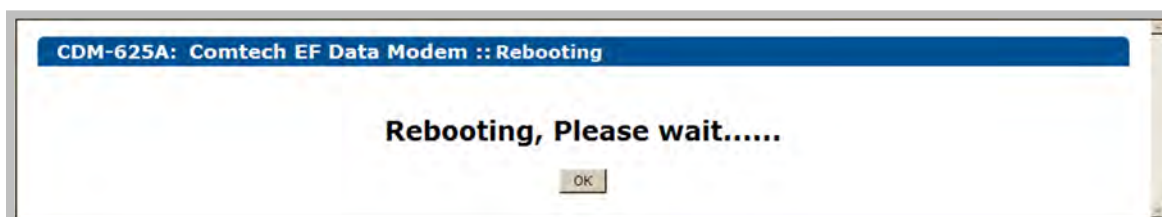

Figure 7-8. Status | Firmware Info | Reboot page

Click **[Reboot Now]** to perform the soft reboot of the CDM-625A. The page updates to indicate the reboot in progress as follows:



Depending on the number of installed hardware and firmware options, it may take up to one minute for soft reboot to execute. Once the CDM-625A “splash” screen appears, you must log in to begin a new HTTP Interface session:

- 1) Click **[OK]** on the 'Rebooting' page to complete the reboot process.
- 2) Upon reboot, you will need to refresh your browser window. Once the Login window appears, type in your **User name** and **Password**.
- 3) Click **[OK]** in the Login window; the browser window will refresh to show the HTTP Interface “splash” (Home) page.
- 4) Select any navigation tab to resume your session.

7.5.4.2.5 Admin | FAST



- Sect. 1.3.8 Fully Accessible System Topology (FAST)
- Chapter 5. FAST ACTIVATION PROCEDURE
- Chapter 6. FRONT PANEL OPERATION

The CDM-625A has a number of optional features that may be activated after the unit’s purchase. **Fully Accessible System Topology (FAST) Access Codes** are register-specific authorization codes that may be purchased from Comtech EF Data, and then activated in the unit using this page. Contact Comtech EF Data Product Support to order the desired options and obtain your unique FAST Access Codes.

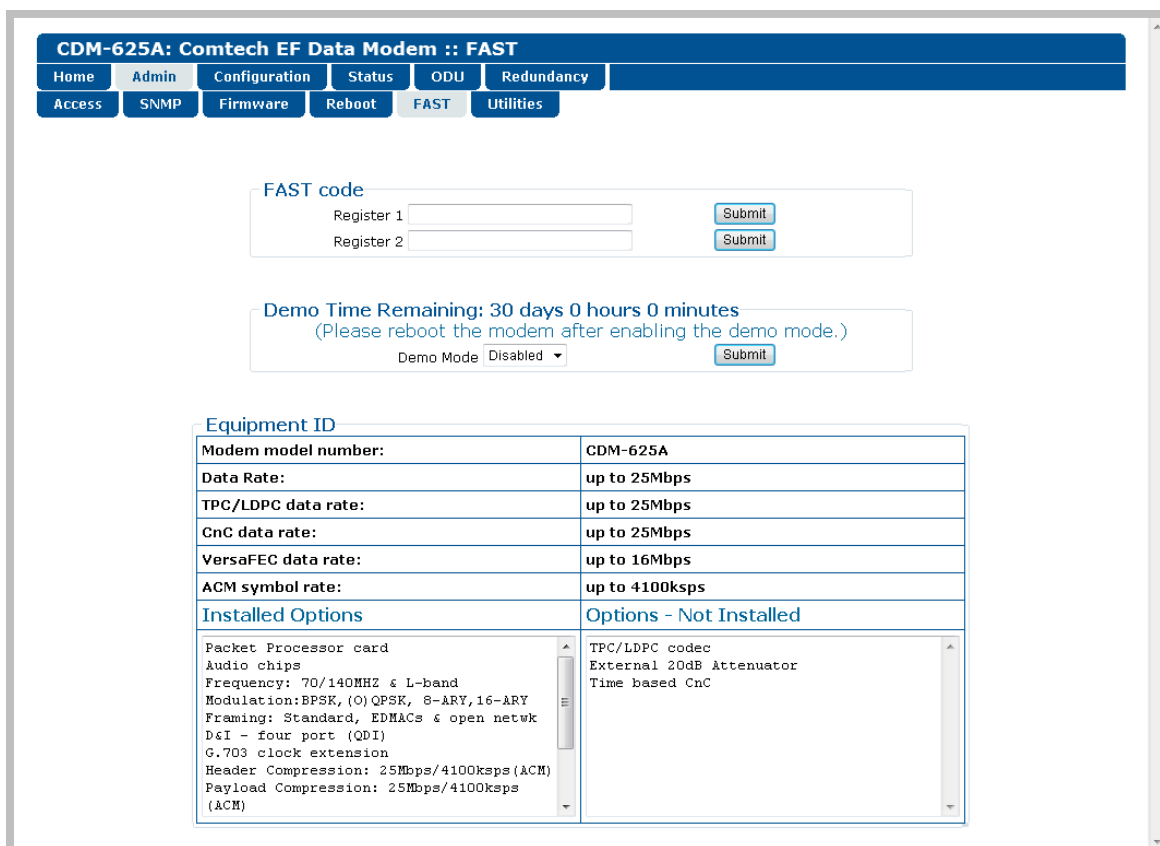

Figure 7-9. Admin | FAST page

FAST code

When you obtain a FAST access code from Comtech EF Data, **it will be for a specific option register**. *Carefully* enter each register-specific 20-character FAST access code in sequence, and then click **[Submit FAST code]** when done. A message will display at the top of this section that states whether or not the codes are accepted or if the upgrade is successful.

Demo Time Remaining:

FAST Options Demo-Mode allows access to **ALL** CDM-625A FAST options* for 30 calendar days. This section displays the remaining time in days, hours, and minutes.



*** The AES Feature is available only when the CDM-625A is equipped with the optional IP Packet Processor with AES software.**

Use the drop-down list to set Demo-Mode as **Enabled** or **Disabled**, and then click **[Submit]** to execute the selection.

Equipment ID

This *read-only* section displays the operational status for a number of FAST-enabled features.

Installed Options

This scrollable, *read-only* list box displays the *installed and presently operational* FAST-enabled features.

Options – Not Installed

This scrollable, *read-only* list box displays the *uninstalled* FAST-enabled features that are *available for purchase and activation* from Comtech EF Data.

7.5.4.2.6 Admin | Utilities

Use this page to “ping” a device on the network for diagnostic purposes.

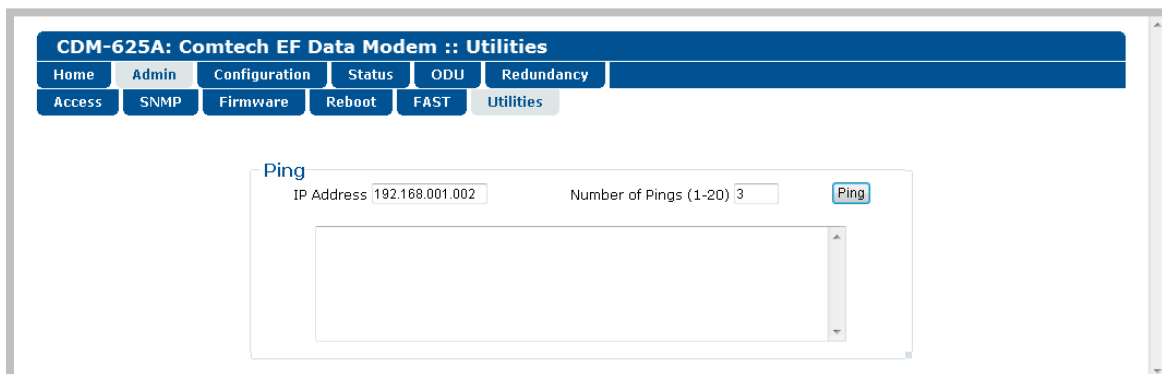

Figure 7-10. Admin | Utilities page

Ping

- **IP Address** – Enter the IP Address for the network device in the format XXX.XXX.XXX.XXX.
- **Number of Pings (1-20)** – Specify the number of ‘ping’ attempts to be executed, from a minimum of 1 up to a maximum of 20 attempts.

- Click **[Ping]** to execute the function. The scrollable window displays the result of the command.

7.5.4.3 Configuration Pages

Use the ‘**Configuration**’ pages to configure all operating parameters for the CDM-625A, including its ODU (Outdoor Units) when connected. Click the **Modem**, **LAN**, **Routing**, **Managed Switch**, **WAN**, **Overhead**, **Utilities**, **D&I**, **BUC**, **LNB**, or **ANT** tab to continue.

7.5.4.3.1 Configuration | Modem



- **Chapter 6. FRONT PANEL OPERATION**
- **Appendix F. DOUBLETALK CARRIER-IN-CARRIER (CnC)OPTION**
- **Appendix M. ADAPTIVE CODING AND MODULATION (ACM) OPTION**

CDM-625A: Comtech EF Data Modem :: Modem Configuration

Home
Admin
Configuration
Status
ODU
Redundancy

Modem
LAN
Routing
Managed Switch
WAN
Overhead
Utilities
D&I
BUC
LNB
ANT
MEO

Interface / Framing

(Submit Tx and Rx Interface Type and Framing Mode BEFORE setting other configuration parameters.)

Tx Interface Type: RS422

Tx Framing Mode: Unframed

Rx Interface Type: RS422

Rx Framing Mode: Unframed

If CnC-APC is active, key transmission/reception parameters (Modulation, FEC type, Code Rate, Framing, Data Rate, Interface) cannot be modified until CnC-APC is suspended. (Go to Overhead tab to suspend or activate.)

Transmit

FEC Type: Viterbi

Modulation Type: QPSK

FEC Code Rate: 1/2

Data Rate: 00064.000 kbps (Synchronous)

Symbol Rate: 00064.000 ksp/s

Frequency: 1070.0000 MHz

Spectrum: Normal

Scrambler: IESS-315

Power Level: 30.0 dBm (minus sign assumed)

Reed-Solomon Encoding: Normal

Data Invert: Normal

Clock Invert: Normal

Ternary Code: B8ZS

Carrier: ON

POCO: Disabled (Use with caution)

Sub-Mux: Off

Sub-Mux Ratio: 1/9 (IP/Synchronous Data)

Tx Filter Rolloff Factor: 0.35

Receive

FEC Type: Viterbi

Demodulation Type: QPSK

FEC Code Rate: 1/2

Data Rate: 00064.000 kbps (Synchronous)

Symbol Rate: 00064.000 ksp/s

Frequency: 1070.0000 MHz

Spectrum: Normal

De-Scrambler: IESS-315

Sweep Width: 10 kHz (+/-)

Reed-Solomon Decoding: Normal

Data Invert: Normal

Clock Invert: Normal

Ternary Code: B8ZS

Eb/No Alarm Pt: 00.1 dB

Receive Equalizer: Disabled

Sub-Mux: Off

Sub-Mux Ratio: 1/9 (IP/Synchronous Data)

Rx Filter Rolloff Factor: 0.35

Carrier-in-Carrier (CnC)

Mode: Off

Search Delay Range: 10 290 ms (min/max)

Freq Offset Range: 030 kHz (+/-)

PMSI mode: Idle

Figure 7-11. Configuration | Modem page (Non-ACM Modes)

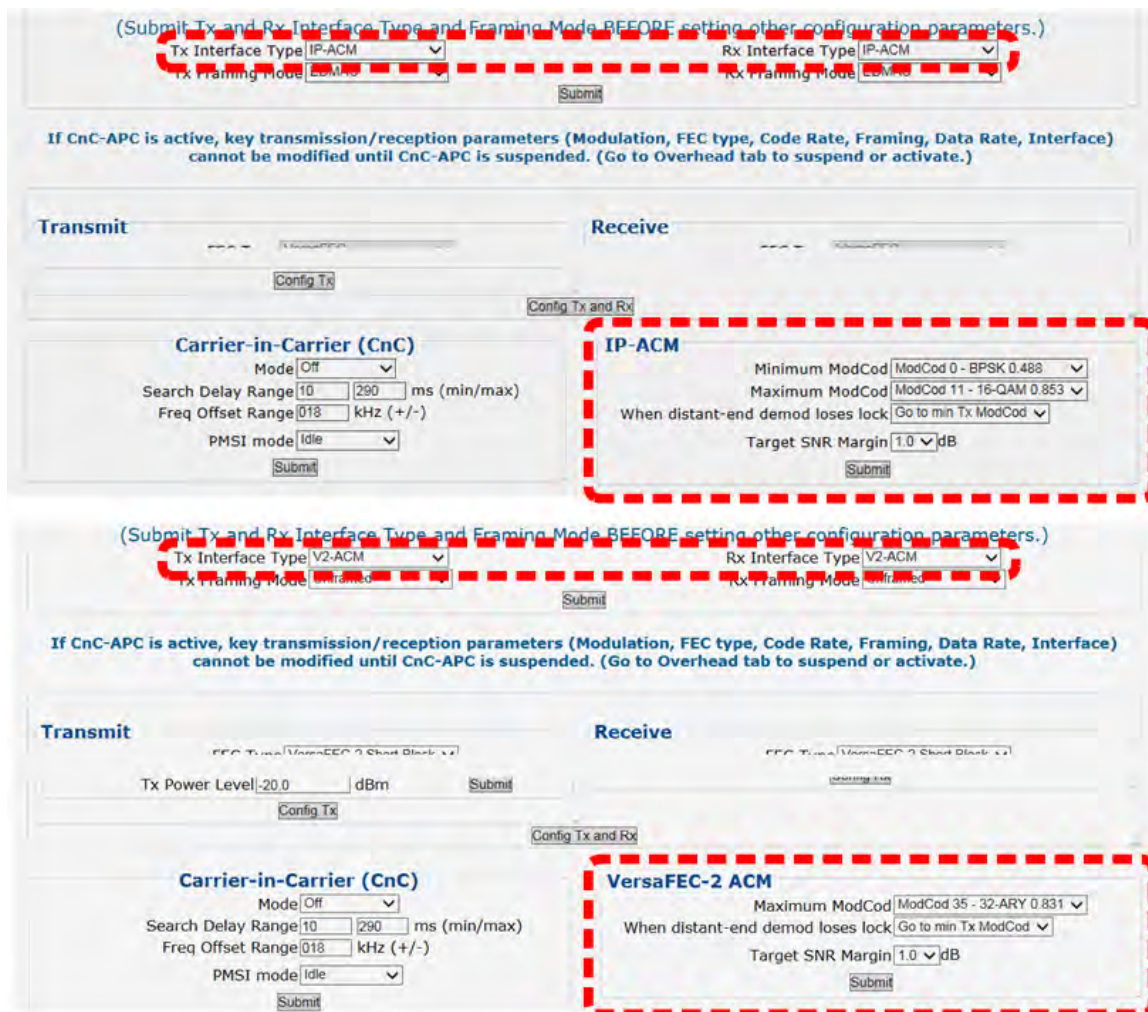

Figure 7-12. Configuration | Modem page (ACM Modes)

Use the 'Configuration | Modem' page to configure these modem operating parameters:

- Tx / Rx Interfaces and Framing*
- Carrier-in-Carrier (CnC) Parameters
- Tx / Rx Operating Parameters
- IP-ACM or VersaFEC-2 ACM Parameters



***The Tx / Rx Interface Types and Framing Modes have higher priority than other parameters, and should be configured before setting other parameters.**

The page appearance changes with your selection of operating mode. Figure 7-11 shows this page as it appears when any non-ACM operating mode is active. When you select IP-ACM or V2-ACM mode, Figure 7-12 shows addition of the pertinent ACM section, to the right of the Carrier-in-Carrier (CnC) section.

Detailed information on operation and configuration settings is provided elsewhere in this manual.

Typical for all page sections, click **[Submit]** to save any changes and settings.

7.5.4.3.2 Configuration | LAN Pages

Click the **IP** tab, the **ARP** tab (only after you **install** and **enable** the optional IP Packet Processor card), or the **Port Monitoring** tab to continue.

7.5.4.3.2.1 Configuration | LAN | IP

CDM-625A: Comtech EF Data Modem :: IP

Home Admin Configuration Status ODU Redundancy
Modem LAN Routing Managed Switch WAN Overhead Utilities D&I BUC LNB ANT MEO
IP ARP

Network Configuration

Ping Reply
 MAC Address
 WAN Buffer Length ms
 L2 QoS
 Dedicated Management Port
 2048 Ethernet Frame Size
 IP Gateway
 Traffic/Mgmt IP Address /
 MAC Learning
 L3 QoS (for PktP)
 Working Mode
 Packet Processor (Use with caution)

Per Port Configuration

Port	Speed	Pause Flow Control	Port Mode	PVID	Priority	Actual Negotiated Port Speed
1	<input type="text" value="Auto"/>	<input type="text" value="Off"/>	<input type="text" value="Access"/>	<input type="text" value="0001"/>	<input type="text" value="1"/>	100 Full
2	<input type="text" value="Auto"/>	<input type="text" value="Off"/>	<input type="text" value="Access"/>	<input type="text" value="0001"/>	<input type="text" value="1"/>	Link Down
3	<input type="text" value="Auto"/>	<input type="text" value="Off"/>	<input type="text" value="Access"/>	<input type="text" value="0001"/>	<input type="text" value="1"/>	Link Down
4	<input type="text" value="Auto"/>	<input type="text" value="Off"/>	<input type="text" value="Access"/>	<input type="text" value="0001"/>	<input type="text" value="1"/>	Link Down

VLAN Mode

VLAN Mode Management VLAN ID

VLAN Table

VLAN Entry - Action Entry
 VLAN ID
 Port 1
 Port 2
 Port 3
 Port 4

VLAN Table

VID	1	2	3	4
0001	U	U	U	U

Figure 7-13. Configuration | LAN | IP page

Network Configuration

- **Ping Reply** – Use the drop-down list to select Ping Reply as **Disabled** or **Enabled**. When **Enabled**, the modem responds to ICMP ping requests.
- **MAC Address** – This parameter is **read-only** and cannot be changed.
- **WAN Buffer Length** – Enter a value between 20ms and 400ms, in 20ms increments.
- **L2 QoS (Layer 2 QoS)** – Use the drop-down list to select this feature as **Off**, **VLAN only**, **Port only**, or **VLAN & Port**.



You may enable L2 QoS only when the optional IP Packet Processor is disabled.

- **Dedicated Management Port** – This feature is available in Managed Switch Mode, but it is unavailable when VLAN Mode is Enabled or when the optional IP Packet Processor is Enabled.

Use the drop-down list to select **Port 1**, **Port 2**, **Port 3**, or **Port 4** as the Dedicated Management Port. If **Port 1 (2,3,4) - Local Only** is selected, management is restricted to *LAN only*. Note that, when the optional IP Packet Processor is Enabled, the drop-down list displays **Disabled** as the sole listed option. When VLAN is Enabled, the drop-down list displays all options as described previously, but the selections are *non-functioning*.

- **2048 Ethernet Frame Size** – This feature is supported only on modems with Hardware Revision 2.X or higher.

Use the drop-down list to select this feature as **Disabled** or **Enabled**.

- **IP Gateway** (*applicable only in Managed Switch Mode*), and **Traffic/Mgmt IP Address** (and subnet mask) – Configure the modem’s IP Addresses using these fields.
- **MAC Learning** (*applicable only in Managed Switch Mode*) – Use the drop-down list to select MAC Learning as **On** or **Off**.
- **L3 QoS** (Layer 3 QoS) – This feature is operational only when you install and enable the optional IP Packet Processor card.

Use the drop-down list to select the L3 (Advanced) QoS as **Off**, **Max/Priority**, **Min Max**, or **DiffServ**.

- **Working Mode** – Use the drop-down list to select the Working Mode as follows:
 - **Managed Switch** – Primarily intended for operation in a point-to-point topology, Managed Switch Mode is Comtech’s IP modem intelligent networking solution. It allows a link to be set up with minimal configuration (no specific routes need to be configured).

When the optional IP Packet Processor is either not installed or is installed but Disabled, Managed Switch Mode provides support for Layer 2 QoS, and Dedicated Management Port or VLAN.

When you install and enable the optional IP Packet Processor, advanced features such as Layer 3 (Advanced) QoS, Header and Payload Compression, Streamline Encapsulation (SLE), and Encryption are available. Most are supported *only* under “Admin” user access.



Sect. 7.5.4.3.4 Configuration | Managed Switch

- **Router Point-to-Point** – Functions as a point-to-point router in Point-to-Point configurations.
- **Router Multipoint Hub** – Functions as the Hub side router in a Point-to-Multipoint network. Allows Satellite-to-Satellite packets to pass.
- **Router Multipoint Remote** – Functions as a Remote Router in a Point-to-Multipoint network. Packets from the WAN are not allowed to be sent to the WAN.
- **Packet Processor** – **This feature is operational only when the optional IP Packet Processor card is installed.** Use the drop-down list to select the IP Packet Processor card as **Enabled** or **Disabled**.



When you change the optional IP Packet Processor card operation (i.e., Enabled or Disabled), after you click the [Submit] tab the modem is forced to reboot and you will see the following message:

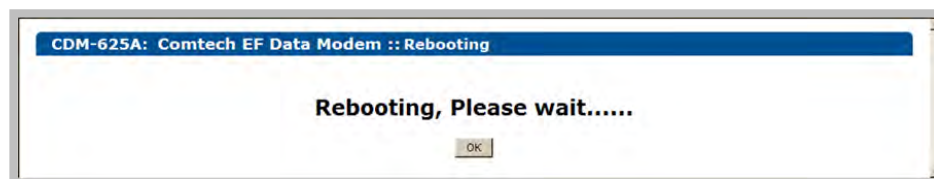

Note that, before clicking [OK] to proceed with reboot of the modem, you may first need to clear the PC's ARP table.

Click **[Submit]** to save.

Per Port Configuration

Set the parameters on a per-port basis (**Port 1** through **Port 4**). Note the following:

Column	Description
Speed	Use the drop-down list to select the speed for each selected port: Auto , 100 Full , 100 Half , 10 Full , or 10 Half .
Pause Flow Control	Use the drop-down list to select Pause Flow Control for the port as Off or On .
Port Mode	Use the drop-down list to select Port Mode for the port as Access or Trunk .
PVID	When Port Mode is Access , a PVID (<i>Native VLAN ID</i>) may be assigned to the selected port using a value range of 0001-4095. (See note about PVIDs (Native VLAN IDs) vs. Management VLAN IDs.)
Priority	Use the drop-down list to set the operational priority of the selected port, in the order of preference (from 1 to 4).
Actual Negotiated Port Speed	This is the status of the current operating actual speed and duplex. If the port is not connected, and then " Link Down " is displayed.

Click **[Submit Port Cnfg]** to save.

VLAN Mode



VLAN Mode is supported in Managed Switch Mode, with or without the optional IP Packet Processor Enabled.

- **VLAN Mode** – Use the drop-down list to select the mode as **Disabled** or **Enabled**.
- **Management VLAN ID** – A Management VLAN ID may be assigned to the selected port using a value range from **0001** to **4095**.



When configuring Access and Management VLAN IDs:

- **The Access VLAN ID (PVID) is used to tag arriving packets that have no VLAN tag. Likewise, when packets arrive from the WAN with the same VLAN tag as the Access VLAN ID, and then the VLAN header is removed and passed to the LAN interface.**
- **The Management VLAN ID is used to specify a dedicated management VLAN used to access and control the modems.**

Click **[Submit]** to save.

VLAN Table

- **VLAN Entry / Action** – Set the table entry action as **None**, **Edit**, **Delete**, or **Add**:
 - **None** – No actions will be taken on the VLAN priority rule for the selected VLAN ID.
 - **Edit** – Click to modify an existing VLAN priority rule in the VLAN table. The VLAN rule will be updated in the VLAN Table once the user clicks **[Submit]**.
 - **Delete** – Click to flag a VLAN priority rule for removal from the VLAN Table. The VLAN rule will be deleted from the VLAN Table once the user clicks **[Submit]**.
 - **Add** – Click to add a VLAN priority rule. The entry will be added to the VLAN Table for processing once the user clicks **[Submit]**.
- **VLAN ID** – This parameter is **read-only** and reflect the ID value assigned in the **Per Port Configuration** section of this page (i.e., any ID has a value range of 0001-4095).
- **Port 1 through Port 4** – Use the drop-down list to select the port as **Untagged**, **Tagged**, or **Filtered**.
- **Action** – Use the drop-down list to select the action for this active ID as **None**, **Edit**, **Delete**, or **Add**.

Click **[Submit]** to save.

- **VLAN Table** – This *read-only* table provides the user with the status for VLAN entry on a per-ID (0001-4095) and per-Port (1-4) basis, where **U=Untagged**, **T=Tagged**, and **F=Filtered**.

7.5.4.3.2.2 Configuration | LAN | ARP



This nested page is accessible only to Admin users and when you **install** and **enable** the optional IP Packet Processor card. See Sect. 7.5.3.1 for complete details about using conditional access pages.

ARP (Address Resolution Protocol) is a technique by which the HTTP Interface in Router Mode on a given network answers the ARP queries for a network address that is not on this network, but is reachable via the IP Packet Processor Interface.

Use this page to configure the modem’s ARP parameters.

Figure 7-14. Configuration | LAN | ARP page

ARP Table (Edit)

This section displays all current Static and Dynamic ARP entries, and allows to user to directly edit the current Static ARP entries, when more than one ARP entry exists. Note the following:

Column	Description
Index	This is the internal table index that is automatically assigned and cannot be edited.
IP	IP Address, in the format XXX.XXX.XXX.XXX.
MAC	MAC Address, in the format YY:YY:YY:YY:YY:YY.
Type	Type is identifiable as Static or Dynamic (cannot be edited).

Click **[Submit Changes]** to save.

Add Static ARP

This section allows you to directly add a static ARP entry. Note that the index will automatically increment to the next available number.

Click **[Add Entry]** to save.

Delete Static ARP

Enter Entry Index to Delete, and then click **[Delete Entry]** once all changes have been made in this section.

Flush Dynamic ARPs

Click **[Flush ARP Table]** to delete all dynamically learned ARP entries.

7.5.4.3.2.3 Configuration | LAN | Port Monitoring

Port monitoring allows a port's ingress and/or egress traffic to be mirrored on another port. This is useful for link monitoring or packet capturing without interrupting live traffic.

The screenshot shows the 'Port Monitoring' configuration page for the CDM-625A modem. The page has a blue header with the title 'CDM-625: Comtech EF Data Modem :: Port Monitoring'. Below the header is a navigation menu with tabs for Home, Admin, Configuration, Status, ODU, Redundancy, Modem, LAN, Routing, Managed Switch, WAN, Overhead, Utilities, D&I, BUC, LNB, ANT, IP, and ARP. The 'Port Monitoring' tab is selected. The main content area contains a form with the following fields: 'Port Monitoring' (set to 'Enabled'), 'Source (Monitoring)' (set to 'Port 2'), 'Destination (Capturing)' (set to 'Port 3'), and 'Direction' (set to 'Both (Rx & Tx)'). A 'Submit' button is located at the bottom of the form.

Figure 7-15. Configuration | LAN | Port Monitoring Page

Port Monitoring

- **Port Monitoring** – Use the drop-down list to select function as **Disabled** or **Enabled**.
- **Source (Monitoring)** – Use the drop-down list to select **WAN**, **Port 1**, **Port 2**, **Port 3**, or **Port 4** as the source port from which to direct mirror traffic.
- **Destination (Capturing)** – Use the drop-down list to set the port to which to direct captured traffic – **Port 1**, **Port 2**, **Port 3**, or **Port 4**.



You cannot specify the port that is currently selected as the **Source (Monitoring) port to also be the **Destination (Capturing)** port. For example, if you have selected **Port 1** as the **Source (Monitoring)** port, and you then select **Port 1** as the **Destination (Capturing)** port, once you click [Submit] the modem rejects your selections and reverts back to the previously saved and valid settings.**

- **Direction** – Use the drop-down list to set the traffic flow between the Source and Destination ports as **Ingress (Rx)**, **Egress (Tx)**, or **Both (Rx & Tx)**.

7.5.4.3.3 Configuration | Routing Pages



The nested Routes, IGMP, and DHCP pages are accessible only to Admin users and when you install and enable the optional IP Packet Processor card. See Sect. 7.5.3.1 for complete details about using conditional access pages.

Click the Routes, IGMP, DHCP, or DNS tab to continue.

7.5.4.3.3.1 Configuration | Routing | Routes



Use this page to enter static routes into the IP Packet Processor to route IP traffic over the satellite or to another device on the local LAN.

Figure 7-16. Configuration | Routing | Routes page

Route Table (Edit)

This section displays and allows you to edit all current Route Table entries. Note the following:

Column	Description
Index	This is the internal table index that is automatically assigned and cannot be edited.
Desc.	This label helps to maintain the network. Enter a label string in this text box. The assigned name must be unique and cannot contain any whitespace.
Dest.IP/Mask	Enter a Destination IP Address/Mask in the form XXX.XXX.XXX.XXX/YY.
Interf.	Use the drop-down list to select the Interface as toWAN or toLAN .
Next HOP IP	Enter the desired Next Hop IP Address for toLAN routes. Note that no Next Hop entry is needed for toWAN routes.
Header Comp.	When the optional Header Compression FAST feature is available, use the drop-down list to Disable or Enable operations.

Column	Description
Payload Comp.	When the optional Payload Compression FAST feature is available, use the drop-down list to Disable or Enable operations.
Encryption	When the optional AES Encryption FAST feature is available, use the drop-down list to Disable or Enable operations.  With AES Encryption disabled, all routed traffic is transmitted 'in the clear' regardless of the Encryption Key specified in the Route Table.
Encryption Key	With encryption <i>enabled</i> , use the drop-down list to select Key 1 through Key 8 (assigned using the ' Configuration WAN Encryption ' page, Sect. 7.5.4.3.5.3) or Random Key .  You must program all eight encryption and decryption keys before selecting Random Key – otherwise, the modem will select any of the eight allotted keys, even if a key is currently clear (set to all zeroes).

Click **[Submit Changes]** to save.

Add New Route

This section allows you to directly add a route entry using text boxes and drop-down lists as described previously for the **Route Table (Edit)** section.

Click **[Add Entry]** to save. Note that, when a new route is added, the index automatically increments to the next available number.

Delete Route

Enter Route Index to Delete, and then click **[Delete Entry]** once all changes have been made in this section. The specified route entry will then be deleted from the route table.

7.5.4.3.3.2 Configuration | Routing | IGMP

This page permits use of Internet Group Management Protocol (IGMP) with configured multicast routes.

IGMP, when enabled, responds to IGMP queries for the configured multicast routes on the transmit side and generates IGMP queries on the receive side. If there are no active IGMP receivers on the LAN, it will stop forwarding the multicast traffic (received from the satellite) to the LAN.

Figure 7-17. Configuration | Routing | IGMP page

IGMP Multicast Router

- **Version** – Use the drop-down list to select **IGMPv1**, **IGMPv2**, or **IGMPv3**.
- **Last Member Query Interval** – This is the maximum response time inserted into group-specific queries that are set in response to Leave Group messages, and it is also the amount of time between group-specific query messages. This value may be tuned to modify the "leave latency" of the network; a reduced value results in reduced time to detect the loss of the last member of a group.

Enter a value, in seconds, from **1** to **25** (default = 1 second).

- **Query Interval** – This is the interval between general queries sent by the modem. By varying the query interval, a modem administrator may tune the number of IGMP messages on the subnet; note that larger numbers cause the IGMP queries to be sent less often.

Enter a value, in seconds, from **1** to **18000** (default = 125 seconds)

- **Query Response Interval** – This is the maximum response time inserted into the periodic general queries. By varying the Query Response Interval, a modem administrator may tune

the “burstiness” of IGMP messages on the subnet; note that larger values make the traffic less “bursty” as host responses are spread out over a large interval.

Enter a value, in seconds, from **1** to **25** (default = 10 seconds).



The number of seconds assigned to the Query Response Interval must be less than the Query Interval.

Click **[Submit]** to save.

IGMP Joined Groups

This *read-only* table lists the IGMP Groups that are active on the modem. This allows you to determine which services are being used and the minimum time before a service will be terminated.

Click **[Refresh]** to update this section with its latest available statistics.

Multicast Routes

This *read-only* table lists the Multicast Routes that are active on the modem.

Click **[Refresh]** to update this section with its latest available statistics.

7.5.4.3.3.3 Configuration | Routing | DHCP

Use this page to set up the DHCP (Dynamic Host Configuration Protocol) Relay feature.

DHCP allows a device to be configured automatically – eliminating the need for intervention by a network administrator – and provides a server located at the hub for keeping track of devices that are connected to the network. This prevents two devices from accidentally being configured with the same IP Address.

The CDM-625A DHCP Relay feature allows you to deploy a single DHCP server at the hub that manages all of the devices throughout your remote networks. When a device on the CDM-625A's network issues a DHCP request, it is relayed to the DHCP server as specified by the "DHCP Server IP Address". The DHCP response is then sent directly to the requesting device.

CDM-625A: Comtech EF Data Modem :: DHCP

Home Admin Configuration Status ODU Redundancy
Modem LAN Routing Managed Switch WAN Overhead Utilities D&I BUC LNB ANT MEO
Routes IGMP DHCP DNS

DHCP Relay

Relay Feature:

DHCP Server IP Address:

Figure 7-18. Configuration | Routing | DHCP page

DHCP Relay

- **Relay Feature** – Use the drop-down list to **Disable** or **Enable** the DHCP Relay Feature.
- **DHCP Server IP Address** – Specify the IP Address to be used for the DHCP server at the hub in the form XXX.XXX.XXX.XXX.

Click **[Submit]** to save.

7.5.4.3.3.4 Configuration | Routing | DNS

Use this page to manage DNS (Domain Name System) caching. DNS caching provides an efficient way for DNS to keep the Internet synchronized as the IP addresses of some servers change and as new servers come online.

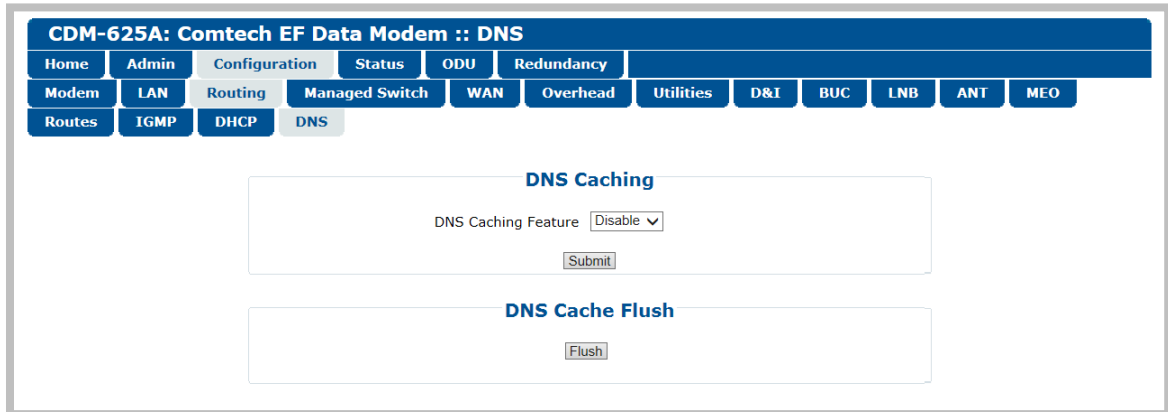

Figure 7-19. Configuration | Routing | DNS page

DNS Caching

Use the drop-down list to set DNS as **Enabled** or **Disabled**. Click **[Submit]** to save.

DNS Cache Flush

Click **[Flush]** to clear the DNS Cache of all data.

7.5.4.3.4 Configuration | Managed Switch



The features on this nested page are accessible only to Admin users and when you install and enable the optional IP Packet Processor card. See Sect. 7.5.3.1 for complete details about using conditional access pages.

For configuration of Managed Switch Mode features that do not require the presence or enabling of the optional IP Packet Processor (i.e., L2 QoS, Dedicated Management Port, VLAN Mode), see Sect. 7.5.4.3.2.1 Configuration | LAN | IP.

Managed Switch Mode is primarily intended for operation in a point-to-point topology. It supports VLAN as well as advanced features such as QoS, Header Compression, Payload Compression, and Encryption/Decryption.

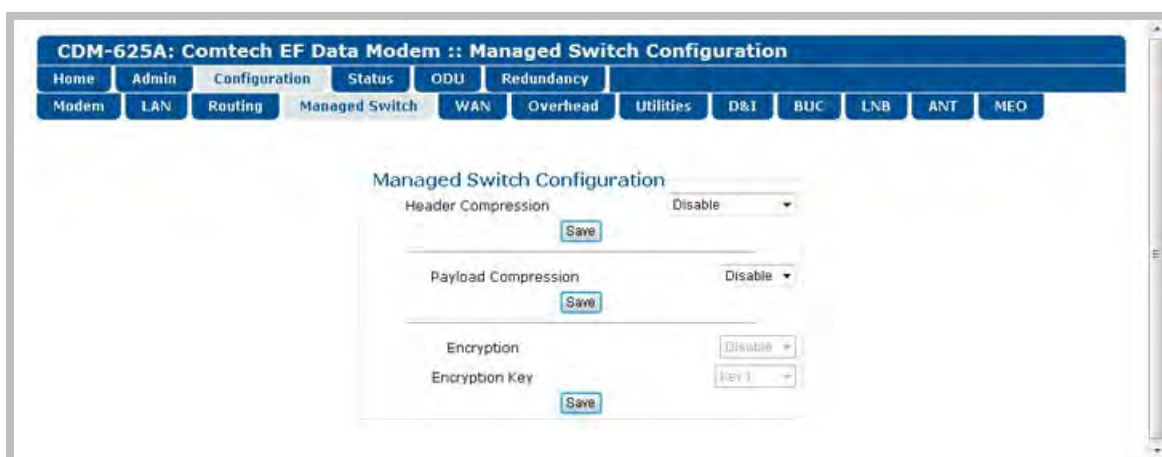

Figure 7-20. Configuration | Managed Switch page

Managed Switch Configuration

- **Header Compression** – When this optional feature is available, use the drop-down list select Header Compression as **Disable**, **L2 Enabled**, or **L2/L3 Enabled**.

Click **[Save]** when done.

- **Payload Compression** – When this optional feature is available, use the drop-down list to **Disable** or **Enable** Payload Compression.

Click **[Save]** when done.

- **Encryption** – When this optional feature is available, use the drop-down list to **Disable** or **Enable** Encryption.

- **Encryption Key** – When this optional feature is available and encryption is **Enabled**, the Encryption keys are used to encrypt traffic being sent over the satellite interface:

- Select **Key 1** through **Key 8** to use the key specified in the Encryption/Decryption Configuration Page (**Sect. 7.5.4.3.5.3**) to encrypt WAN traffic.
- Select **Disable** to force the IP Module to *not* encrypt any WAN traffic.
- Select **Random** to cause the IP Module to randomly use any of the eight Tx Keys to encrypt the traffic destined for the satellite link.

Click [**Save**] when done.

7.5.4.3.5 Configuration | WAN Pages



The nested **QoS**, **Compression**, and **Encryption** pages are accessible only to **Admin** users and when you **install** and **enable** the optional **IP Packet Processor** card. See **Sect. 7.5.3.1** for complete details about using conditional access pages.

Click the **QoS**, **Compression**, or **Encryption** tab to continue.

7.5.4.3.5.1 Configuration | WAN | QoS Pages

The '**Configuration | WAN | QoS**' page is viewable only when QoS is **enabled** for operation.

When you **disable** QoS and you select the nested **QoS** tab, in place of a 'populated' page the following message appears:

QoS is off.
To enable QoS, go to Configuration > LAN > [IP](#) and use the QoS drop-down box.

When you **enable** QoS, the appearance of this page depends on the active mode of QoS operation. The active mode appears at the upper left-hand page corner, below the nested **QoS** menu tab:

- **Max/Priority** Mode or **Min/Max** Mode (see **Figure 7-21**)
- **DiffServ** Mode (see **Figure 7-22**)

A navigation prompt also displays after the QoS mode label as follows:

(To change QoS mode, go to Configuration > LAN > [IP](#))

Note that **IP** is a hyperlink that provides direct navigation to this configuration page.

Segmentation and Reassembly (SAR)

This section is identical for the "Max/Priority," "Min/Max," and "DiffServ" pages.

Packet Segmentation and Reassembly (SAR) is an adaptive process; it will trigger only if the packet latency exceeds the threshold value (default to 25 msec). SAR is needed, when running small-speed (<700 kbps) links, to keep latency and jitter within specifications (25 msec latency/10 msec jitter) when the lower priority queue contains large packets.

Use the drop-down list to select SAR as **Disable** or **Enable**, and then click [**Submit**].

7.5.4.3.5.1.1 Configuration | WAN | QoS Pages – Max/Priority, Min/Max Modes

CDM-625A: Comtech EF Data Modem :: QoS

Home | Admin | Configuration | Status | ODU | Redundancy

Modem | LAN | Routing | Managed Switch | WAN | Overhead | Utilities | D&I | BUC | LNB | ANT | MEO

QoS | Compression | Encryption

Max/Priority (To change QoS mode, go to Configuration > LAN > [IP](#))

Segmentation and Reassembly (SAR)

SAR Feature

QoS Rules Table													
Index	Protocol	VLAN Range	TOS	Src IP/Mask	Dst IP/Mask	Min Src Port	Max Src Port	Min Dst Port	Max Dst Port	Max Bw (Kbps)	Priority	WRED	Filter All
1	All	0-4094	255	0.0.0.0/0	0.0.0.0/0	0	65535	0	65535	99999	8	Disable	Disable

Add New QoS Rule

Protocol	VLAN Range	TOS	Src IP/Mask	Dst IP/Mask	Min Src Port	Max Src Port	Min Dst Port	Max Dst Port	Max Bw (Kbps)	Priority	WRED	Filter All
UDP	0-4094	255	0.0.0.0/0	0.0.0.0/0	0	65535	0	65535	99999	1(Highest)	Disable	Disable

Delete Rule

Enter Rule Index to Delete

Delete All Max/Pri QoS Rules - Use With Caution

Delete All Rules?

QoS Rules Table													
Index	Protocol	VLAN Range	TOS	Src IP/Mask	Dst IP/Mask	Min Src Port	Max Src Port	Min Dst Port	Max Dst Port	Min Bw (Kbps)	Max Bw (Kbps)	WRED	Filter All
1	All	0-4094	255	0.0.0.0/0	0.0.0.0/0	0	65535	0	65535	0	99999	Disable	Disable

Add New QoS Rule

Protocol	VLAN Range	TOS	Src IP/Mask	Dst IP/Mask	Min Src Port	Max Src Port	Min Dst Port	Max Dst Port	Min Bw (Kbps)	Max Bw (Kbps)	WRED	Filter All
UDP	0-4094	255	0.0.0.0/0	0.0.0.0/0	0	65535	0	65535	0	99999	Disable	Disable

Delete Rule

Enter Rule Index to Delete

Delete All Min/Max QoS Rules - Use With Caution

Delete All Rules?

(TOP) QoS Control Mode = Max/Priority
 (BOTTOM) QoS Control Mode = Min/Max (Banner, Menu Bar, SAR section not shown)

Figure 7-21. Configuration | WAN | QoS Pages

QoS Rules Table

For the 'Max/Priority' page:

QoS Rules Table													
Index	Protocol	VLAN Range	TOS	Src IP/Mask	Dst IP/Mask	Min Src Port	Max Src Port	Min Dst Port	Max Dst Port	Max Bw (Kbps)	Priority	WRED	Filter All
1	All	4094-4094	255	0.0.0.0/0	0.0.0.0/0	0	65535	0	65535	99999	8	Disable	Disable

For the 'Min/Max' page:

QoS Rules Table													
Index	Protocol	VLAN Range	TOS	Src IP/Mask	Dst IP/Mask	Min Src Port	Max Src Port	Min Dst Port	Max Dst Port	Min Bw (Kbps)	Max Bw (Kbps)	WRED	Filter All
1	All	4094-4094	255	0.0.0.0/0	0.0.0.0/0	0	65535	0	65535	0	99999	Disable	Disable

This section displays all *existing* QoS Rules Table entries. From left to right:

Column	Description
Index	This is the internal table index that is automatically assigned and cannot be edited.
Protocol	Specifies the protocol for the specific rule.
VLAN Range	Specifies the minimum-to-maximum range of VLAN IDs (applicable only in Managed Switch Mode)
TOS	Specifies the Type Of Service
Src IP/Mask	Identifies the Source IP Address/Mask in the form XXX.XXX.XXX.XXX/YY.
Dst IP/Mask	Identifies the Destination IP Address/Mask in the form XXX.XXX.XXX.XXX/YY.
Min Src Port	Specifies the Minimum Source Port.
Max Src Port	Specifies the Maximum Source Port.
Min Dst Port	Specifies the Minimum Destination Port.
Max Dst Port	Specifies the Maximum Destination Port.
Max BW (Kbps)	("Max/Priority" page only) Specifies the maximum bandwidth value.
Min BW (Kbps)	("Min/Max" page only) Specifies the minimum bandwidth value.
Priority	("Max/Priority" page only) Specifies the priority established for the specific rule.
WRED	Specifies the WRED (Weighted Random Early Detection) setting for the specific rule as Disable or Enable .
Filter All	Specifies the flow filter setting for the specific rule as Disable or Enable .

Add New QoS Rule

This section allows you to directly **add** a *new* rule entry. Note that the index will automatically increment to the next available number.

For the "Max/Priority" page:

Add New QoS Rule												
Protocol	VLAN Range	TOS	Src IP/Mask	Dst IP/Mask	Min Src Port	Max Src Port	Min Dst Port	Max Dst Port	Max Bw (Kbps)	Priority	WRED	Filter All
UDP	0-4094	255	0.0.0.0/0	0.0.0.0/0	0	65535	0	65535	99999	1(Highest)	Disable	Disable
<input type="button" value="Add Rule"/>												

For the “Min/Max” page:

Protocol	VLAN Range	TOS	Src IP/Mask	Dst IP/Mask	Min Src Port	Max Src Port	Min Dst Port	Max Dst Port	Min Bw (Kbps)	Max Bw (Kbps)	WRED	Filter All
UDP	0-4094	255	0.0.0.0/0	0.0.0.0/0	0	65535	0	65535	0	99999	Disable	Disable

[Add Rule](#)

From left to right:

Column	Description
Protocol	Use the drop-down list to select the Protocol as UDP, TCP, ICMP, RTP, VOICE, VIDEO, RTPS, FTP, HTTP, TELNET, SMTP, SNMP, All-IP, Non-IP, or All.
VLAN Range	Enter the minimum-to-maximum range of VLAN IDs from 0-4094 (applicable only in Managed Switch Mode).
TOS	Enter the Type of Service.
Src IP/Mask	Enter a Source IP Address/Mask in the form XXX.XXX.XXX.XXX/YY.
Dst IP/Mask	Enter a Destination IP Address/Mask in the form XXX.XXX.XXX.XXX/YY.
Min/Max Src Port	Selection of Source/Destination Ports should only be done if you are aware of the port usage of the desired protocol or application. There are well-known ports for various protocols, but often only the 'command' messaging is transacted on these ports and the 'data' is transferred through a negotiated port.
Min/Max Dst Port	
Min BW (Kbps)	(“Min/Max” page only) Assign a value to a flow to restrict the Minimum Bandwidth that any particular flow will utilize; otherwise, the default of no bandwidth restriction can be selected.
Max BW (Kbps)	Assign a value to a flow to restrict the Maximum Bandwidth that any particular flow will utilize; otherwise, the default of no bandwidth restriction can be selected.
Priority	(“Max/Priority” page only) Use the drop-down list to assign a Priority Level from 1 to 8 for each flow: <ul style="list-style-type: none"> • The IP Module classifies each packet that is to be forwarded over the satellite; the packet then has a Priority assigned according to the defined QoS Rules; • Any latency critical traffic such as VoIP/RTP should always be assigned Priority 1; • Priority 1 packets are forwarded immediately; Priority 2 packets are forwarded as soon as there are no Priority 1 packets in the Queue; and so on; • Any packet that does not meet a QoS Rule is assigned to the Default Rule and is assigned a Priority of 9.
WRED	Use the drop-down list to set WRED (Weighted Random Early Detection) as Disable or Enable .
Filter All	Use the drop-down list to set Filter All to Disable or Enable . QoS allows specific flows to be designated as 'filtered' so the IP Packet Processor card will discard traffic that you do not want to forward over a satellite link.

For either page, click [Add Rule] to execute the addition of the new rule to the QoS Rules Table.

Delete Rule

This section is identical for both the “Max/Priority” and “Min/Max” pages.



Enter Rule Index to Delete, and then click [**Delete Rule**] to execute deletion of the specified rule from the QoS Rules Table.

Delete All (Max/Pri, Min/Max) QoS Rules – Use With Caution

For the ‘Max/Priority’ page:



For the ‘Min/Max’ page:



For either page, use the drop-down list to select **Yes**, and then click [**Submit**] to execute the deletion of **all rules** from the QoS Rules Table.

7.5.4.3.5.1.2 Configuration | WAN | QoS Pages – DiffServ Mode

QoS can be set to DiffServ Mode to make it fully compliant to the Differentiated Services QoS RFC (Request For Comments) standards.



Sect. R.3.3.2 Layer 3 QoS List of Supported RFCs (Requests for Comment) – Appendix R. QUALITY of SERVICE (QoS)

CDM-625A: Comtech EF Data Modem :: QoS

Home Admin Configuration Status ODU Redundancy

Modem LAN Routing Managed Switch WAN Overhead Utilities D&I BUC LNB ANT MEO

QoS Compression Encryption

DiffServ (To change QoS mode, go to Configuration > LAN > IP)

Segmentation and Reassembly (SAR)

SAR Feature

Differentiated Services

ASFD Precedence Based Priority ASFD Bandwidth Mode

Priority	Per-Hop Behavior (PHB)	Codepoint (DSCP)	Service Rate (Kbps)	Service Rate (%)	Low Drop Precedence (%full) xx=01	Med. Drop Precedence (%full) xx=10	High Drop Precedence (%full) xx=11
1	Class Selector 7	111000					
2	Class Selector 6	110000					
3	Expedited Forwarding	101110					
3	Class Selector 5	101000					
4	Class Selector 4	100000					
5	Class Selector 3	011000					
6	Class Selector 2	010000					
7	Class Selector 1	001000					
8	Assured Forwarding Class 4	100xx0	<input type="text" value="16"/>	<input type="text" value="0"/>	<input type="text" value="100"/>	<input type="text" value="75"/>	<input type="text" value="50"/>
8	Assured Forwarding Class 3	011xx0	<input type="text" value="16"/>	<input type="text" value="0"/>	<input type="text" value="100"/>	<input type="text" value="75"/>	<input type="text" value="50"/>
8	Assured Forwarding Class 2	010xx0	<input type="text" value="16"/>	<input type="text" value="0"/>	<input type="text" value="100"/>	<input type="text" value="75"/>	<input type="text" value="50"/>
8	Assured Forwarding Class 1	001xx0	<input type="text" value="16"/>	<input type="text" value="0"/>	<input type="text" value="100"/>	<input type="text" value="75"/>	<input type="text" value="50"/>
9	Default	000000					

Figure 7-22. Configuration | WAN | QoS page (DiffServ Mode)

Differentiated Services

ASFD Precedence Based Priority – Use the drop-down list to select **Disable** or **Enable**:

- In the default **disabled** state, the priorities of all Assured Forwarding Classes are the same (Priority = 8).
- When **enabled**, the priorities for Assured Forwarding Classes are the same as the priorities of the corresponding Class Selector.

ASFD Bandwidth Mode – Use the drop-down list to select **Datarate** or **Percentage**:

- In the default **Datarate** mode, the minimum bandwidths for all Assured Forwarding Classes are those that are specified in the **Service Rate (Kbps)** column.
- In **Percentage** mode, the minimum bandwidths for all Assured Forwarding Classes are calculated (as a percentage of modems current TX data rate) using values that are specified in the **Service Rate (%)** column.

For the Differentiated Services tabulature – From left to right, note the following:

Column	Description
Priority	IP traffic is prioritized based upon the DSCP (DiffServ Code Points) Class Selector Precedence.
Per-Hop Behavior (PHB)	Traffic class that determines how packets will be forwarded.
Codepoint (DSCP)	Codepoint value in Type of Service (ToS) byte in IP header.

The user has the option of configuring each queue to one of the following attributes (the acceptable ranges are shown in brackets):

Column	Description
Service Rate (kbps)	[-0.000 / (Tx Data Rate)] <i>This field is active when the ASFD Bandwidth Mode is set to Datarate.</i> The minimum bandwidth will be served first among the Assured Forwarding (ASFD) classes in case of bandwidth availability once Class Selector 7 through Class Selected 1 have been serviced.
Service Rate (%)	<i>This field is active when the ASFD Bandwidth Mode is set to Percentage.</i> This column is for specifying the minimum service rates (for the Assured Forwarding Classes) as a percentage of modem's current Tx data rate. These minimums are served in case of bandwidth availability once Class Selector 7 through Class Selector 1 has been serviced. This is very handy for ACM links where the modem Tx data rate varies.
Drop Preferences	ASFD Class 4 through 1 Code Points (b100xx0, b011xx0, b010xx0, and b001xx0) carry the drop precedence value (xx). In case of network congestion, a Weighted Random Early Detection (WRED) congestion avoidance algorithm is imposed on these queues to drop the packets randomly rather than 'tail drop.' <ul style="list-style-type: none"> • Low Drop Precedence (% full) [0–100] – In case of congestion, the WRED is applied after the queue depth exceeds the configured percentage value assigned for the Drop Precedence value b001. • Med. Drop Precedence (% full) [0–99] – In case of congestion, the WRED is applied after the queue depth exceeds the configured percentage value assigned for the Drop Precedence value b010. • High Drop Precedence (% full) [0–99] – In case of congestion, the WRED is applied after the queue depth exceeds the configured percentage value assigned for the Drop Precedence value b011.

Click **[Submit]** to save.

7.5.4.3.5.2 Configuration | WAN | Compression

Use this page to configure the optional Payload and Header Compression, when this FAST feature is enabled.

CDM-625A: Comtech EF Data Modem :: Compression

Home Admin Configuration Status ODU Redundancy

Modem LAN Routing Managed Switch WAN Overhead Utilities D&I BUC LNB ANT MEO

QoS Compression Encryption

Compression Availability
Enable or disable: [Configuration > Managed Switch](#).

Router Mode Header Compression

Header Comp. RTP Refresh Rate (1-600)

Header Comp. UDP Refresh Rate (1-600)

Header Comp. Default Refresh Rate (1-600)

Router Mode Payload Compression

Payload Comp. Refresh Rate pkts (1-255)

Figure 7-23. Configuration | WAN | Compression page

Compression Availability

This section provides a hyperlink to the ‘**Configuration | Managed Switch**’ page (see **Sect. 7.5.4.3.4**). Use this “Managed Switch” link to enable Header and Payload Compression.

Header Compression

- **Header Comp. RTP Refresh Rate** – Enter a time for the Real Time Protocol refresh rate, from **1** to **600** seconds.
- **Header Comp. UDP Refresh Rate** – Enter a time for the User Datagram Protocol refresh rate, from **1** to **600** seconds.
- **Header comp. Default Refresh Rate** – Enter a time for the Default Protocol refresh rate, from **1** to **600** seconds.

Click **[Submit]** to save.

Payload Compression

- **Payload Comp. Refresh Rate** – Enter for the Payload Compression refresh rate, in number of packets, from **1** to **255**.

7.5.4.3.5.3 Configuration | WAN | Encryption



FAST features such as Encryption may be purchased from Comtech EF Data Sales Representatives during normal business hours. See Sect. 5.2.8 SELECT: FAST Menus or Chapter 5. FAST ACTIVATION PROCEDURE in this manual for additional information about activating FAST features.

This page allows configuration of the optional AES Encryption, when this FAST feature is enabled. When AES Encryption is active and enabled on a WAN route, the IP Packet Processor will encrypt all outgoing traffic on the WAN, and decrypt any encrypted traffic it receives.

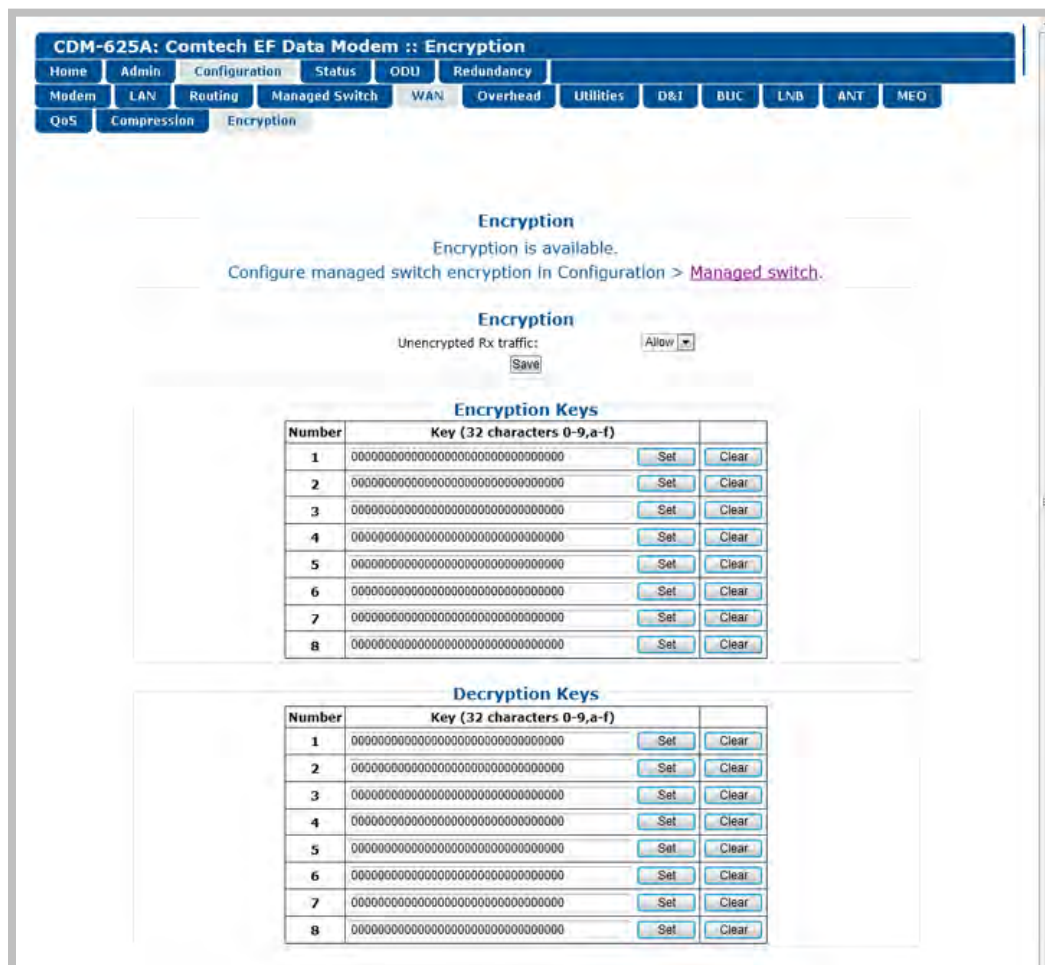

Figure 7-24. Configuration | WAN | Encryption page

Encryption Status Section

This section displays the active state of the AES Encryption option:

- Per the example shown in **Figure 7-24**, when the AES Encryption FAST feature is **enabled**, this section displays the message **“Encryption is available.”** All functionality of this page is operable – you can encrypt a specific route. Route encryption is set using the **‘Configuration | Routing | Routes’** page (see **Sect. 7.5.4.3.3.1**) when the modem is in a router mode, or the

'**Configuration | Managed Switch**' page (see **Sect. 7.5.4.3.4**) when the modem is in Managed Switch Mode.

- When the AES Encryption FAST feature has *not* been purchased and is therefore **disabled**, the **Encryption** section of this page appears as follows:

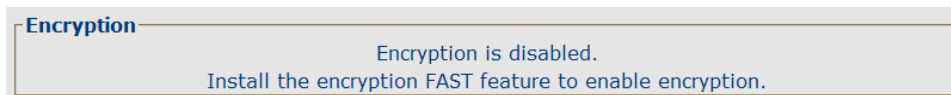

While the AES Encryption FAST feature itself is **disabled**, the this page may still be used to program the Encryption and Decryption keys in anticipation of future use.

For situations where, for example, export restrictions prohibit the availability of the AES Encryption option, the CDM-625A runs an FPGA chipset that does not allow encryption operations. The '**Configuration | WAN | Encryption**' page is therefore **disabled**: The page, when accessed, notes the operational restriction by hiding the **Encryption Key** and **Decryption Key** programming sections and displaying the following message in the **Encryption** section:

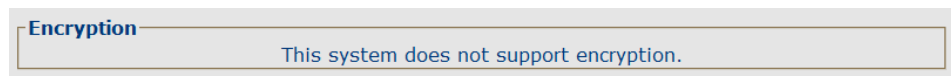

Encryption – Unencrypted Rx Traffic

Use the drop-down list to select **Allow** (default) or **Drop**. Note the following:

- Under the default **Allow** setting, the local modem *allows* receipt of unencrypted (plain text) packets from the remote modem over the WAN, even when encryption is enabled.
- Under the **Drop** setting, the modem *drops* all unencrypted traffic received over the WAN interface when encryption is enabled. The remote modem may therefore transmit only encrypted data.

Encryption / Decryption Keys

A typical encryption or decryption key consists of a string of 32 characters, using any combination of the numbers '0' through '9' and the letters 'a' through 'f' / 'A' through 'F'.

To program a key, enter the desired 32-character string in the appropriate key row, and then click **[Set]**. *Any previously programmed key may be overwritten in this manner.* Alternately, click **[Clear]** to reset a previously programmed entry to all zeroes, and then re-enter the new key string as instructed here.

Up to eight keys may be programmed for each function; once set, you may then select a specified *Encryption Key* for active use via the '**Configuration | Routing | Routes**' page (**Sect. 7.5.4.3.3.1**).



The user must program all eight encryption and decryption keys before selecting Random Key operation on the 'Configuration | Routing | Routes' page. Otherwise,

the modem will select any of the eight allotted keys, even if a key is currently clear (set to all zeroes).

7.5.4.3.6 Configuration | Overhead



This page appearance depends on whether Carrier-in-Carrier Automatic Power Control (CnC-APC) Mode is selected.



Chapter 6. FRONT PANEL OPERATION

(TOP) Page when CnC-APC mode is not selected
 (BOTTOM) Page with CnC-APC mode selected (Banner, Menu Bar not shown)

Figure 7-25. Configuration | Overhead page

Use this page to configure the following overhead interfaces:

- **ESC** including Tx / Rx IDR Esc Type, Audio Volume, High Rate ESC
- **IDR Backward Alarms** for Tx 1-4 and Rx 1-4
- **AUPC** (when Carrier-in-Carrier Automatic Power Control is disabled/de-activated)
- **CnC-APC** (when Carrier-in-Carrier Automatic Power Control is enabled/activated)



See Sect. F.6 Carrier-in-Carrier Automatic Power Control (CnC-APC) in Appendix F. DOUBLE TALK CARRIER-IN-CARRIER OPTION for complete details about, and setup of, the CnC-APC feature.

- **EDMAC** Framing Mode and Slave Address

Click **[Submit]** to save.

7.5.4.3.7 Configuration | Utilities pages

Click the **Utilities1** or **CarrierID** tab to continue.

7.5.4.3.7.1 Configuration | Utilities | Utilities1

The screenshot shows the 'Utilities' page for a CDM-625A modem. The page is organized into a grid of configuration sections. At the top, there are navigation tabs for various system functions, with 'Utilities' currently selected. Below the tabs, there are sub-tabs for 'Utilities 1' and 'Carrier ID'. The main content area is divided into several sections, each with its own title and configuration options:

- Redundancy:** Contains a 'Force 1:1 Switch' button.
- Re-Center Buffer:** Contains a 'Re-Center Buffer' button.
- Unit:** Includes dropdown menus for 'Test Mode' (Normal), 'Stats Sample Interval' (10 Minutes), 'Front Panel Lockout' (No Lockout), 'RTS/CTS Control' (RTS/CTS Loop, No Action), and 'HSSI Handshake Control' (TA to CA loop). A 'Submit Unit Utilities' button is at the bottom.
- Clocks:** Includes dropdown menus for 'Tx Clock Source' (Internal), 'Rx Clock Source' (Rx Satellite), 'External Frequency Reference' (Internal), and 'G.703 Clock Extend Interface' (T1). It also has a text input for 'Rx Buffer Size' (00016 bytes) and a 'G.703 Clock Extend Mode' dropdown (None). A 'Submit Clocks' button is at the bottom.
- Circuit ID:** Features a text input field for 'Circuit ID' and a 'Submit' button.
- Date & Time:** Includes text inputs for 'Time (Format is HH:MM:SS)' (17:01:53) and 'Date (Format is DD/MM/YY)' (10/11/14), along with an 'Enter Date/Time' button.
- BERT Config:** Includes dropdown menus for 'Tx' (On), 'Rx' (On), and 'Error Insert' (Off). It also has dropdown menus for 'Pattern' (2*20-1) for both Tx and Rx. A 'Submit BERT' button is at the bottom.
- BERT Monitor:** Displays 'Errors: 0000000', 'BER: No Sync', and 'Sync: No Sync'. It includes 'Restart' and 'Update' buttons.
- Save / Load:** A section at the bottom with a 'Submit Save/Load' button, 'Save Location' (Don't Save), and 'Load Location' (Don't Load) dropdown menus.

Figure 7-26. Configuration | Utilities | Utilities1 page

Redundancy

If the unit is part of a 1:1 redundant pair of modems, and this unit is currently online, click **[Force 1:1 Switch]** to cause the unit to switch to standby.

Re-Center Buffer

Click **[Re-Center Buffer]** to force the re-centering of the Plesiochronous/Doppler buffer.

Unit

Use the drop-down lists provided in this section to configure **Test Mode**, **Stats Sample Interval**, **Front Panel Lockout**, **RTS/CTS Control**, and **HSSI Handshake Control**.

Click **[Submit Unit Utilities]** to save.

Clocks

Use the drop-down lists provided in this section to configure **Tx / Rx Clock Sources**, **Rx Buffer Size**, **External Clock**, **External Frequency Reference**, and **G.703 Clock Extended Mode / Interface**.

Click **[Submit Clocks]** to save.

Circuit ID



It is **IMPORTANT** to understand that **Circuit ID** and the **MetaCarrier Custom Message** are two distinct features of the CDM-625A. Read your documentation carefully.

With **Carrier ID Enabled**, the first 24 characters of the 40-character **Circuit ID** are intended for and sent as the **MetaCarrier Custom Message**. While you must limit your **MetaCarrier Custom Message** to 24 characters or less, the full 40 characters of the **Circuit ID** will display on the front panel screen saver (see Sect. 6.1.3.1 Screen Saver).



Appendix D. CARRIER ID (MetaCarrier®)

Enter a *Circuit ID* string of up to 40 character. You may use the following characters to compose either string:

[Space] () * + - , . / 0-9 and A-Z.

Date and Time

- Enter a date using DD/MM/YY format (where DD = day [01 to 31], MM = month [01 to 12], and YY = year [00 to 99]).
- Enter a time using HH:MM:SS format (where HH = hour [00 to 23], MM = minutes [00 to 59], and SS = seconds [00 to 59]).

Click **[Enter Date/Time]** once you set the desired date and time.

BERT Config

Use the drop-down lists provided in this section to configure *Bit Error Rate Test* for **Tx** or **Rx** as **On** or **Off**; configure the *pattern* for **Tx** or **Rx**; and set *Error Insertion* as either **Off** or **10E-3**.

Click **[Submit BERT]** once you select the desired BERT settings.

BERT Monitor

This *read-only* section displays the ongoing BERT. Click **[Restart]** to restart the BERT Monitor, or **[Update]** to refresh a test already in progress.

Save / Load (Save takes precedence over Load)



The **Save/Load** feature stores and retrieves the **CDM-625A Base Modem settings only**. It does not include the optional **IP Packet Processor settings**.

As a safeguard, to prevent any inadvertent action the **Save Location** and **Load Location** drop-down lists' default selections are **Don't Save** and **Don't Load**, respectively. Otherwise:

- **Save Location / Load Location** – Use the drop-down lists to save or load up to 10 different modem configurations – **0** through **9**. An empty location is noted on its menu line as **Available**.

Click [**Submit Save/Load**] to save.

7.5.4.3.7.2 Configuration | Utilities | Carrier ID



Appendix D. CARRIER ID (MetaCarrier®)

CDM-625A: Comtech EF Data Modem :: Carrier ID

Home Admin Configuration Status ODU Redundancy
Modem LAN Routing Managed Switch WAN Overhead Utilities D&I BUC LNB ANT MEO
Utilities 1 Carrier ID

Meta-Carrier Info

MAC Address: 00:06:B0:00:02:D7
Latitude: 33 ° 25.43 ' N
Longitude: 111 ° 58.28 ' W
Telephone Number: +18664723963
Custom Message: Comtech EFData
Carrier ID State: OFF
Submit

Figure 7-27. Configuration | Utilities | Carrier ID page

MetaCarrier Info

- **MAC Address** – This parameter is **read-only** and cannot be changed.
- **Latitude** – Enter a value, for degrees, from **0** to **90**. Enter a value, for minutes, from **00.00** to **59.99**. Use the drop-down list to select **N** (North) or **S** (South).
- **Longitude** – Enter a value, for degrees, from **0** to **180**. Enter a value, for minutes, from **00.00** to **59.99**. Use the drop-down list to select **E** (East) or **W** (West).
- **Telephone Number** – Enter a phone number. Valid characters are **+**, **x**, **0-9**.
- **Custom Message** – Enter a MetaCarrier Custom Message as needed, up to 24 characters. You may use the following characters to compose this string:

[Space] () * + - , . / 0-9 and A-Z.

The MetaCarrier Custom Message, as created here, also appears in the title bar of compatible web browsers for easy unit identification.



It is IMPORTANT to understand that the Carrier ID and MetaCarrier Custom Message are two distinct features of the CDM-625A. Read your documentation carefully.

With Carrier ID Enabled, the first 24 characters of the 40-character Circuit ID are intended for and sent as the MetaCarrier Custom Message. While you must limit your MetaCarrier Custom Message to 24 characters or less, the full 40 characters of the Circuit ID will display on the front panel screen saver (see Sect. 6.1.3.1 Screen Saver).

- **Carrier ID State** – Use the drop-down list to set Carrier ID operation as **ON** or **OFF**.

Click **[Submit]** to save.

7.5.4.3.8 Configuration | D&I (Drop and Insert)



- For D&I configuration information: Chapter 6. FRONT PANEL OPERATION
- For D&I functionality overview: Appendix E. CLOCK MODES AND DROP AND INSERT (D&I).

Figure 7-28. Configuration | D&I page (Selected Framing Mode = D&I)

The appearance of this page is dependent on the framing mode selected on the ‘**Configuration | Modem**’ page (Sect. 7.5.4.3.1). If the selected framing mode is **D&I++**, the section heading and the available parameters adjust accordingly:

If the selected framing mode is **Quad Drop & Insert**, the section heading and the available parameters adjust accordingly:

Click **[Submit]** to save.

7.5.4.3.9 Configuration | BUC (Block Up Converter)



Chapter 10. CDM-625A ODU (TRANSCEIVER, BUC, LNB) OPERATION

After configuring the CDM-625A for L-Band operation, and when a Block Up Converter (BUC) is installed, you may use this page to configure its operating parameters and to view the BUC operational status.

Figure 7-29. Configuration | BUC page

7.5.4.3.10 Configuration | LNB (Low Noise Block Down Converter)



Chapter 10. CDM-625A ODU (TRANSCEIVER, BUC, LNB) OPERATION

After configuring the CDM-625A for L-Band operation, and when a Low Noise Block Down Converter (LNB) is installed, you may use this page to configure its operating parameters and to view the LNB operational status.

Figure 7-30. Configuration | LNB page

7.5.4.3.11 Configuration | ANT (Advanced Network Timing) Pages



Sect. K.7 Advanced Network Timing (ANT) (Appendix K. ETHERNET NETWORK CONFIGURATION)

The ANT feature provides IP-based protocols to synchronize the modem's internal time-of-day clock to an external device such as a time server, Base Station Controller (BSC), or Radio Network Controller (RNC).

Select the **PTP** or **SNTP** tab to continue.

7.5.4.3.11.1 Configuration | ANT | PTP (Precision Time Protocol)



Sect. K.7.3 PTP (Precision Time Protocol) (Appendix K. ETHERNET NETWORK CONFIGURATION)



All network devices between the Grandmaster and Slave devices must support PTP for sub-microsecond accuracy.

Precision Time Protocol (PTP) is a FAST-activated feature used to synchronize computer clocks throughout a computer network. On LANs, PTP achieves clock accuracy in the sub-microsecond range – much more accurate than what is attainable by NTP (Network Time Protocol) – and it is also used in network applications where GPS is either unaffordable or inaccessible.

CDM-625A: Comtech EF Data Modem :: PTP

Home Admin Configuration Status ODU Redundancy

Modem LAN Routing Managed Switch WAN Overhead Utilities D&I BUC LNB ANT MEO

PTP **SNTP**

PTP

Feature: Grandmaster:

Transport Mode: Unicast Master:

Unicast Sync Interval:

Status

PTP Engine:	Running	PTP Time:	2015-06-02 13:24:52.740
PTP Port:	2, Link Down	RTC Time:	2015-06-02 13:24:52.000
PTP Domain:	4		

Figure 7-31. Configuration | ANT | PTP page

PTP

- **Feature** – Use the drop-down list to set PTP operation as **Enabled** or **Disabled**.

If **Enabled**, PTP is used to establish independent Wireless Receiver/Transmitter (WRT) protocol segments – one for LAN and the other for WAN. If **Disabled**, by default the

availability of the PTP protocol is dependent on the near-end (e.g., the RNC/BSC) and distant-end (e.g., the BTS) IEEE 1588v2 (PTP) capable network devices in the network.

- **Grandmaster** – Use the drop-down list to assign from which port the PTP Grandmaster receives messages: the **LAN** port or the **WAN** port.
- **Transport Mode** – Use the drop-down list to select **Unicast** or **Multicast**:
 - If you select **Unicast**, Unicast negotiation is enabled and the PTP Domain number is set to 4.
 - If you select **Multicast**, Multicast negotiation is enabled and the PTP Domain number is set to 0.
- **Unicast Sync Interval** – Use the drop-down list to select the synchronization interval of packets per second for messages sent from the Master to the Slave. Available selections are:
 - 1 message every 2 seconds
 - 1 message per second
 - 2 messages per second
 - 4 messages per second
 - 8 messages per second
 - 16 messages per second
 - 32 messages per second
 - 64 messages per second



Use Unicast Sync Interval only when the Grandmaster is LAN port and the Transport Mode is Unicast.

Click **[Submit]** to save.

Status

Click **[Refresh]** to update this section with its most recently accumulated statistics.

These status parameters are **read-only** and cannot be changed. Note the following:

Row	Title	Description
Top	PTP Engine	Specifies whether or not PTP is actively attempting to synchronize time.
	PTP Time	Displays the time that is synchronized with the master device and is being propagated to the slave devices.
Middle	PTP Port	Displays whether or not the Ethernet link is detected. The PTP Port is always Ethernet Port 2 on the modem.
	RTC Time	Displays the presumed time for the modem. While the PTP time depends on the Grandmaster device, the RTC Time changes only when set by the user.
Bottom	PTP Domain	Identifies the PTP Domain as '0' when in Multicast Transport Mode, or '4' when in Unicast Transport Mode.

7.5.4.3.11.2 Configuration | ANT | SNTP (Simple Network Timing Protocol)



Sect. K.7.1 Simple Network Timing Protocol (SNTP) (Appendix K. ETHERNET NETWORK CONFIGURATION)

Simple Network Time Protocol (SNTP) is used to synchronize computer clocks throughout a computer network when the ultimate performance of the full NTP implementation as per RFC-1305 (Requests for Comment No. 1305: Network Time Protocol, Version 3, Specification, Implementation and Analysis) is not needed or justified.

Figure 7-32. Configuration | ANT | SNTP page

SNTP

- **Feature** – Use the drop-down list to select SNTP operation as **Disabled** or **Enabled**.
- **Time Zone** – Use the drop-down list to select your desired time zone. Available selections are:

GMT	GMT+01:00	GMT+02:00	GMT+03:00	GMT+03:30	GMT+04:00
GMT+04:30	GMT+05:00	GMT+05:30	GMT+05:45	GMT+06:00	GMT+06:30
GMT+07:00	GMT+08:00	GMT+09:00	GMT+09:30	GMT+10:00	GMT+10:30
GMT+11:00	GMT+12:00	GMT+13:00	GMT+14:00	GMT-12:00	GMT-11:00
GMT-10:00	GMT-09:00	GMT-08:00	GMT-07:00	GMT-06:00	GMT-05:00
GMT-04:30	GMT-04:00	GMT-03:30	GMT-03:00	GMT-02:30	GMT-02:00
GMT-01:00					

- **Primary / Backup Ethernet Time Server** – Enter the desired Time Server’s IP Address in the form XXX.XXX.XXX.XXX.
- **Last Update** – This *read-only* field displays the time and date that the selected server was last updated. The time is shown in military format (HH:MM:SS); the date is shown in **DAY-MONTH-YEAR** format in accordance with European convention. This line specifies “Never” if no update information exists.

Click **[Submit]** to save.

Date and Time

- Enter a time using HH:MM:SS format
(where HH = hour [00 to 23], MM = minutes [00 to 59], and SS = seconds [00 to 59]).
- Enter a date using DD/MM/YY format
(where DD = day [01 to 31], MM = month [01 to 12], and YY = year [00 to 99]).

Click **[Enter Date/Time]** once you set the desired date and time.

7.5.4.3.11.3 Configuration | MEO (Medium Earth Orbit)



You must have the optional IP Packet Processor installed and active, IP-ACM or V2-ACM as the active operating mode, and Carrier-in-Carrier disabled for any MEO Operational Modes to be accessible. Otherwise, this page is nonfunctional.

CDM-625A Advanced Satellite Modems are configurable for continuous pairing as Primary and non-Primary Modems in an Antenna Handover System when the MEO (Medium Earth Orbit) feature is enabled.

Ethernet data traffic is transmitted and received via the Primary and Non-Primary CDM-625's four 10/100 Ethernet ports. The Antenna Handover signal received from the user-provided IF/Rf switch determines which modem is the ONLINE or OFFLINE unit:

- The ONLINE unit transmits traffic only to the WAN side while, at the same time, the OFFLINE unit's Tx is muted.
- Both the ONLINE and OFFLINE units receive the satellite traffic, but only the ONLINE unit forwards traffic to the LAN side while the OFFLINE unit drops the packets.
- Any time a unit switches from the OFFLINE to ONLINE state, the traffic destined for the WAN is buffered, preconfigured in milliseconds (base modem → Antenna Handover delay).

CDM-625A: Comtech EF Data Modem :: MEO

Home Admin Configuration Status ODU Redundancy
Modem LAN Routing Managed Switch WAN Overhead Utilities D&I BUC LNB ANT MEO

MEO

Feature

Antenna Handover

Handover Type
Feature
Mode
ACU IP Address
Communication Port
Handover Delay (msec)
Differential Path Delay (msec)

Figure 7-33. Configuration | MEO page

MEO

- **Feature** – Use the drop-down list to select MEO as **Disabled** or **Enabled**.

Click **[Submit]** to save.

Once the MEO feature is **enabled**, you may set the Antenna Handover operating parameters.

Antenna Handover

- **Handover Type** – Use the drop-down list to select **Break Before Make** or **Make Before Break**.
- **Feature** – Use the drop-down list to select Antenna Handover operation as **Disabled** or **Enabled**.
- **Mode** – Use the drop-down list to set the Antenna Handover action as **Auto** or **Manual**.
- **ACU IP Address** – This *read-only* item displays the IP Address generated by the active Antenna Controller Unit.
- **Communication Port** –
- **Handover Delay** –
- **Differential Path Delay** –

7.5.4.4 Status Pages

The **Status** pages provide you with status, event logging, and operational statistics windows. Click the **Modem Status**, **Modem Logs**, **Modem Info**, **Traffic Statistics**, or – when you **install** and **enable** the optional IP Packet Processor card – the **Performance** tab to continue.

7.5.4.4.1 Status | Modem Status

Use this page to view *read-only* status window pertaining to:

- Alarms
- CnC (Carrier-in-Carrier)
- Fractional CnC Counters
- Rx Parameters
- ACM*
- AUPC
- General Status

CDM-625A: Comtech EF Data Modem :: Modem Status		
Home	Admin	Configuration
Status		ODU
Redundancy		
Modem Status	Modem Logs	Modem Info
Traffic Statistics		Performance
Alarms		RX Parameters
Unit:	None	BER: Demod Unlocked
Tx:	None	SNR: Demod Unlocked
Rx:	Demod Lock	Freq Offset: Demod Unlocked
Open Network:	None	Signal Level: LT-53 dBm
BUC:	None	Buffer Fill State: Demod Unlocked
LNB:	None	Uncorrected BER: Demod Unlocked
AUPC		CnC
Remote Eb/No:	EDMAC Disabled	Delay: Demod Unlocked
Tx Power Level Increase:	AUPC Disabled	Offset: Demod Unlocked
		Power Ratio: Demod Unlocked
		PSDR: Demod Unlocked
ACM		General Status
Tx ModCod:	00 QPSK 0.489	Redundancy: Online
Rx ModCod:	Not Available	Temperature: +47 °C
Remote SNR:	No Sync	Events Log, Unread Lines: 104
Local SNR:	No Sync	
Fractional CnC Counters		
1-year Operational Counter:	Fractional CnC Uninstalled seconds	
90-day CnC usage Counter:	Fractional CnC Uninstalled seconds	

Figure 7-34. Status | Modem Status page (IP-ACM or V2-ACM Mode Active)

*When a non-ACM mode is active, the ACM section of this page appears as follows:

ACM	
Tx ModCod:	Not in ACM
Rx ModCod:	Not in ACM
Remote SNR:	Not in ACM
Local SNR:	Not in ACM

7.5.4.4.2 Status | Modem Logs



Chapter 6. FRONT PANEL OPERATION

Click the **Base Modem** tab, or – when you **install** and **enable** the optional IP Packet Processor card – the **Packet Processor** tab to continue.

7.5.4.4.2.1 Status | Modem Logs | Base Modem

Use this page to control how the fault, statistics, and alarm masking parameters are processed by the unit.

Figure 7-35. Status | Modem Logs | Base Modem page

Events Log

When events are present, information is viewable as per this example:

- **Read Next Five Events** – Click to buffer the next group of five stored events into the scrollable events window.

- **Clear Events Log** – Click to wipe clean the stored events log.
- **Initialize Events Pointer** – Click to reset the log’s internal pointer.
- **Unread Events** – This box displays the total number of *unread* stored events available for review. This number decrements accordingly as stored event groups are displayed in the scrollable window.

Click **[Submit]** to save.

Statistics Log



If you change your operating mode between Non-ACM and ACM (IP-ACM or V2-ACM) modes, Comtech EF Data recommends that you execute the Clear Statistics Log feature before retrieving any further statistics.

Under normal operation, this section contains statistics information as per this example:

MinSNR	AvgSNR	Max&MinModCod	MinRSL	AvgRSL	Time	Date
Loss	Loss	08 08	-50.2	-50.2	12:48:14	05-11-14
Loss	Loss	08 08	-50.2	-50.2	12:58:14	05-11-14
Loss	Loss	08 08	-50.2	-50.2	13:08:14	05-11-14
Loss	Loss	08 08	-50.2	-50.2	13:18:14	05-11-14
Loss	Loss	08 08	-50.2	-50.2	13:28:14	05-11-14

Unread Statistics: 250

- **Read Next Five Statistics** – Click to buffer the next group of five stored statistics into the scrollable statistics window.
- **Clear Statistics Log** – Click to wipe clean the stored statistics log.
- **Initialize Statistics Pointer** – Click to reset the log’s internal pointer.
- **Unread Statistics** – This box displays the total number of *unread* stored statistics available for review. This number decrements accordingly as stored statistics are displayed in the scrollable window.

Click **[Submit]** to save.

Alarm Mask

Submit Alarm Mask

Use the option buttons provided to define a designated alarm as **Masked** or **Active**, and then click **[Submit Alarm Mask]** to save these changes.

7.5.4.4.2 Status | Modem Logs | Packet Processor



This nested page is accessible only to Admin users and when you install and enable the optional IP Packet Processor card. See Sect. 7.5.3.1 for complete details about using conditional access pages.

This page provides you with a scrollable window showing the optional IP Packet Processor’s cumulative events, plus control over what information is displayed for IP Packet Processor operations.

Figure 7-36. Status | Modem Logs | Packet Processor page

Event Logging

- **Logging On/Off** – Select event logging as **On** or **Off**.
- **Logging Level** – Use the drop-down list to select the type of information displayed in the log: **Errors Only**, **Errors and Warnings**, or **All Information**.

Click **[Submit]** once the desired settings have been entered in this section.

Clear Event Log

Scroll through the Event Log as needed, and then click **[Clear Log]** to wipe the log clean. The table resets to a single event description – **“Event log cleared.”**

Event Logging Table

The Event Log table displays a maximum of 256 events. Each event is assigned a sequential **Index** number; its type, the date and time of occurrence, and a description of the event follows.

Click **[Clear Log]** to wipe the log clean.

7.5.4.4.3 Status | Modem Info

Use this page to view *read-only* information about the currently configured modem:

- **General Information**
- **Equipment ID**
- Scrollable windows listing **Installed Options** and available **Options – Not Installed**

CDM-625A: Comtech EF Data Modem :: Modem Information

Home Admin Configuration Status ODU Redundancy

Modem Status Modem Logs Modem Info Traffic Statistics Performance

General Information	
Circuit ID:	-----
Serial Number:	000000000
Software Revision:	1.3.1
Active Software Image:	Image 2
Hardware Revision:	02.0
Viterbi Firmware Version:	0
Local/Remote:	Ethernet Remote
Front Panel Lockout:	No lockout

Equipment ID	
Modem model number:	CDM-625A
Data Rate:	up to 25Mbps
TPC/LDPC data rate:	up to 25Mbps
CnC data rate:	up to 25Mbps
VersaFEC CCM data rate:	up to 16Mbps
VersaFEC ACM symbol rate:	up to 4100ksps
VersaFEC-2 CCM data rate:	up to 25Mbps
VersaFEC-2 ACM symbol rate:	up to 12500ksps

Installed Options	Options - Not Installed
VersaFEC-2 card Packet Processor card Audio chips Frequency: 70/140MHZ & L-band Modulation: BPSK, (O) QPSK, 8-ARY, 16-ARY, 32-ARY Framing: Standard, EDMACs & open netwk D&I - four port (QDI) G.703 clock extension Header Compression: 25Mbps/12500ksps (ACM) Payload Compression: 25Mbps/12500ksps (ACM) Advanced QoS AES Encryption Advanced Network Timing Carrier ID CnC Activation	TPC/LDPC codec External 20dB Attenuator Time based CnC

Figure 7-37. Status | Modem Info page

7.5.4.4.4 Status | Traffic Statistics Pages

Click the **Ethernet**, **WAN**, or **Clear Counters** tab – and, when you **install** and **enable** the optional IP Packet Processor card – the **Router**, **Managed Switch**, **WAN**, **Compression**, **QoS**, **PTP**, **MAC Table**, or **Clear Counters** tab to continue.

7.5.4.4.4.1 Status | Traffic Statistics | Ethernet

Use this page to view Ethernet Ingress/Egress Statistics on a ‘Per Port’ basis.

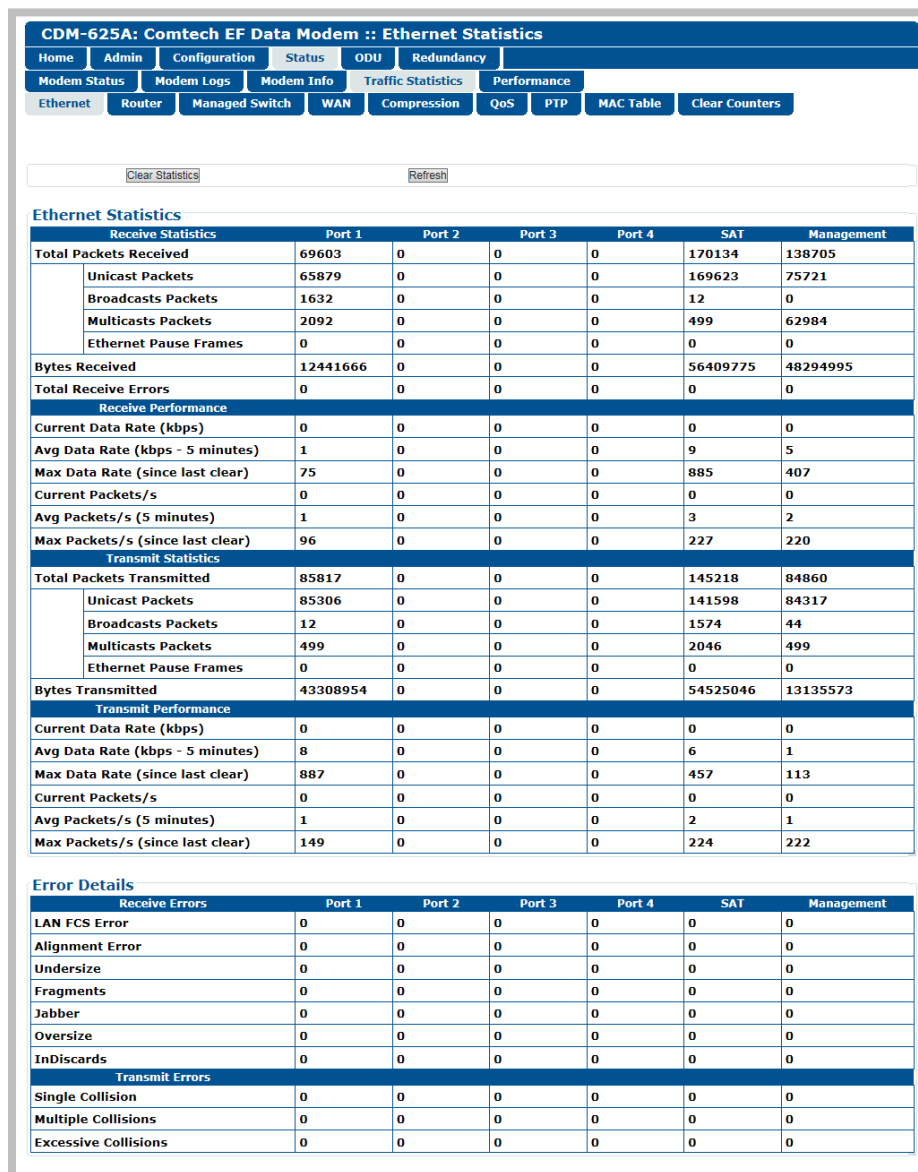

Figure 7-38. Status | Traffic Statistics | Ethernet page

Click **[Clear Statistics]** to clear all Ethernet statistics from the buffer.

Click **[Refresh]** to update the page with the latest available statistics.

7.5.4.4.2 Status | Traffic Statistics | Router



This nested page is accessible only to Admin users and when you install and enable the optional IP Packet Processor card. See Sect. 7.5.3.1 for complete details about using conditional access pages.

Use this page to view cumulative router traffic information.

CDM-625A: Comtech EF Data Modem :: Router Statistics								
Home	Admin	Configuration	Status	ODU	Redundancy			
Modem Status	Modem Logs	Modem Info	Traffic Statistics	Performance				
Ethernet	Router	Managed Switch	WAN	Compression	QoS	PTP	MAC Table	Clear Counters

Clear Statistics

Clear Refresh

Router Counters

Description	Packets
Received Packets	0
Routed Packets	0

Router Errors

Description	Errors
IP Header Errors	0
IP Dest Errors	502
No Route Errors	0
Buffer Full Errors	0

Management Counters

Description	Packets
Management Received Packets	119704
Management Transmitted Packets	170647

Figure 7-39. Status | Traffic Statistics | Router page

Clear Statistics

Click **[Clear]** to clear all router statistics from the buffer.

Click **[Refresh]** to update the page with the latest available statistics.

7.5.4.4.4.3 Status | Traffic Statistics | Managed Switch



This nested page is accessible only to Admin users and when you install and enable the optional IP Packet Processor card. See Sect. 7.5.3.1 for complete details about using conditional access pages.

Use this page to view cumulative Managed Switch traffic information.

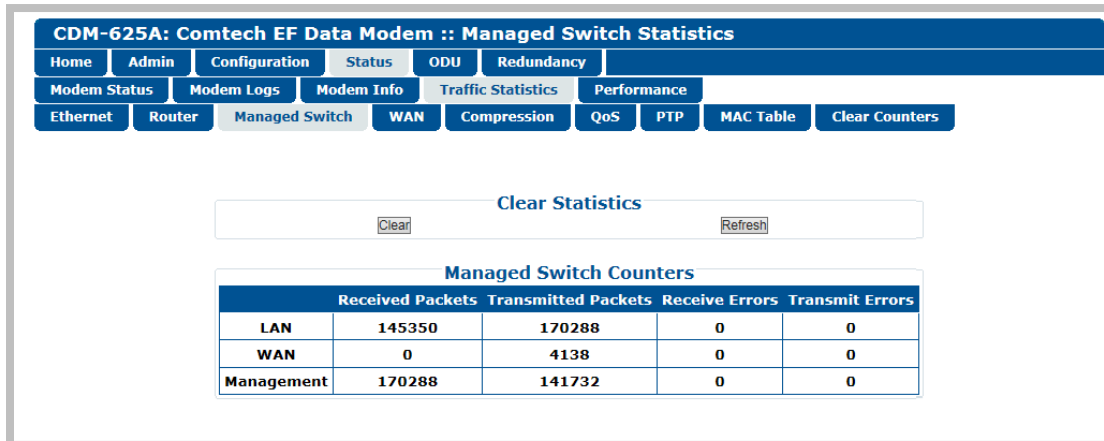

Figure 7-40. Status | Traffic Statistics | Managed Switch page

Clear Statistics

Click **[Clear]** to clear all Managed Switch statistics from the buffer.

Click **[Refresh]** to update the page with the latest available statistics.

7.5.4.4.4 Status | Traffic Statistics | WAN



This appearance of this page depends on whether the optional IP Packet Processor card is not installed / installed but Disabled or if it is installed and Enabled. See Sect. 7.5.3.1 for complete details about using conditional access pages.

Use this page to view cumulative WAN traffic information.

CDM-625A: Comtech EF Data Modem :: WAN Statistics

Home Admin Configuration Status ODU Redundancy

Modem Status Modem Logs Modem Info Traffic Statistics

Ethernet Router Managed Switch WAN Compression QoS PTP MAC Table Clear Counters

WAN Statistics

Clear Statistics

Tx HDLC frame count	509
Rx HDLC frame count	0
Tx Buffer Full Dropped Frames	0
Rx CRC error	0
Average WAN Buffer Fill State	0%

Refresh

CDM-625A: Comtech EF Data Modem :: WAN Statistics

Home Admin Configuration Status ODU Redundancy

Modem Status Modem Logs Modem Info Traffic Statistics Performance

Ethernet Router Managed Switch WAN Compression QoS PTP MAC Table Clear Counters

Clear Statistics

Clear Refresh

WAN Counters

Description	Data Link	Satellite
WAN Tx Frames	4141	64906
WAN Rx Frames	0	0

WAN Tx

Data Rate	1 kbps
Utilization	1 %

WAN Errors

Description	Data Link	Satellite
WAN Tx Errors	0	0
WAN Rx Errors	0	0

Detailed Satellite Rx Errors

Description	Errors
Satellite Rx Frame CRC Errors	0
Satellite Rx Oversized Errors	0
Satellite Rx Undersized Errors	0
Satellite Rx Payload Comp CRC Errors	0
Satellite Rx Overrun Errors	0

(TOP) Page when optional IP Packet Processor is either not installed or installed but Disabled

(BOTTOM) Page when optional IP Packet Processor is installed and Enabled

Figure 7-41. Status | Traffic Statistics | WAN page

For either page version, note the following:

Clear Statistics / WAN Statistics

Click **[Clear]** or **[Clear Statistics]** to clear all WAN statistics from the buffer.

Click **[Refresh]** to update the page with the latest available statistics.

7.5.4.4.5 Status | Traffic Statistics | Compression



This nested page is accessible only to Admin users and when you install and enable the optional IP Packet Processor card. See Sect. 7.5.3.1 for complete details about using conditional access pages.

Use this page to view cumulative Header Compression and Payload Compression statistics.

CDM-625A: Comtech EF Data Modem :: Compression Statistics

Home Admin Configuration Status ODU Redundancy

Modem Status Modem Logs Modem Info Traffic Statistics Performance

Ethernet Router Managed Switch WAN Compression QoS PTP MAC Table Clear Counters

Clear Compression Counters

Clear Refresh

Header Compression Statistics

Index	Pre-Comp. Bytes	Post-Comp. Bytes	Savings (%)	Total Packets	Full Header Packets	Error Packets
1	0	0	0	0	0	0

Payload Compression Statistics

Pre-Comp. Bytes	Post-Comp. Bytes	Savings (%)	Compression Ratio
6255566	0	0	1

Figure 7-42. Status | Traffic Statistics | Compression page

Clear Compression Counters

Click **[Clear]** to clear all compression statistics from the buffer.

Click **[Refresh]** to update the page with the latest available statistics.

7.5.4.4.6 Status | Traffic Statistics | QoS



This nested page is accessible only to Admin users and when you install and enable the optional IP Packet Processor card. Sect. 7.5.3.1 for complete details about using conditional access pages.

Use this page to view cumulative Quality of Service information.

CDM-625A: Comtech EF Data Modem :: QoS Statistics

Home | Admin | Configuration | Status | ODU | Redundancy

Modem Status | Modem Logs | Modem Info | Traffic Statistics | Performance

Ethernet | Router | Managed Switch | WAN | Compression | QoS | PTP | MAC Table | Clear Counters

Clear QoS Counters

QoS Statistics

Index	Description	Tx Packets	Dropped Packets	Tx Packet Rate (packets/s)	Tx Data Rate (kbps)
1	Class Selector 7	0	0	0	0
2	Class Selector 6	0	0	0	0
3	Expedited Forwarding	0	0	0	0
4	Class Selector 5	0	0	0	0
5	Class Selector 4	0	0	0	0
6	Class Selector 3	0	0	0	0
7	Class Selector 2	0	0	0	0
8	Class Selector 1	0	0	0	0
9	Assured Fwd Class 1	0	0	0	0
10	Assured Fwd Class 2	0	0	0	0
11	Assured Fwd Class 3	0	0	0	0
12	Assured Fwd Class 4	0	0	0	0
13	Default	3665	0	0	0

Figure 7-43. Status | Traffic Statistics | QoS page (DiffServ Mode shown)

Clear QoS Counters

Click **[Clear]** to clear all QoS statistics from the buffer.

Click **[Refresh]** to update the page with the latest available statistics.

7.5.4.4.7 Status | Traffic Statistics | PTP



Sect. K.7.3 PTP (Precision Time Protocol) (Appendix K. ETHERNET NETWORK CONFIGURATION)

Use this page to obtain data intended to troubleshoot PTP (Precision Time Protocol) operational issues.

CDM-625A: Comtech EF Data Modem :: PTP Statistics					
Home	Admin	Configuration	Status	ODU	Redundancy
Modem Status		Modem Logs	Modem Info	Traffic Statistics	Performance
Ethernet	Router	Managed Switch	WAN	Compression	QoS
PTP		MAC Table	Clear Counters		

PTP Status <input type="button" value="Refresh"/>	
PTP Offset:	0.00000000
LAN State:	Master
WAN State:	Master

PTP Statistics <input type="button" value="Refresh"/> <input type="button" value="Clear"/>					
	LAN		WAN		
	RX	TX	RX	TX	
Event Port	0	30355	0	30355	
General Port	0	30355	0	30735	
Announce	0	30355	0	30355	
Sync	0	30355	0	30355	
Followup	0	0	0	380	
Delay Req	0	0	0	0	
Delay Resp	0	0	0	0	
Mgmt	0	0	0	0	
Signal	0	0	0	0	
Discarded	0	0	0	0	

Figure 7-44. Status | Traffic Statistics | PTP page

PTP Status

Click **[Refresh]** to update this section with its most recently accumulated statistics.

These status parameters are *read-only* and cannot be changed. Note the following:

Row Title (from top)	Description
PTP Offset	Displays the offset, in seconds, between the modem's slave clock and its master.
LAN State	Displays the state for the clock on the LAN side: <ul style="list-style-type: none"> The State displays as "Slave" when Grandmaster is set to LAN port using the 'Configuration ANT PTP' page (see Sect. 7.5.4.3.11.1). The State displays as "Master" when Grandmaster is set to WAN port using the 'Configuration ANT PTP' page (see Sect. 7.5.4.3.11.1).

Row Title (from top)	Description
WAN State	<p>Displays the state for the clock on the WAN side:</p> <ul style="list-style-type: none"> The State displays as “Slave” when Grandmaster is set to LAN port using the Configuration ANT PTP page (see Sect. 7.5.4.3.11.1) The State displays as “Master” when Grandmaster is set to WAN port using the Configuration ANT PTP page (see Sect. 7.5.4.3.11.1).

PTP Statistics

Click **[Refresh]** to update the page with the latest available statistics.

Click **[Clear]** to clear all PTP statistics from the buffer.

This statistics table breaks down the number of PTP packets sent (Tx columns) or received (Rx columns) on the LAN and WAN ports as follows:

Row Title (from top)	Description
Event Port	Number of packets (PTP or other) transmitted/received on the PTP UDP event-message port.
General Port	Number of packets (PTP or other) transmitted/received on the PTP UDP general-message port.
Announce	Number of PTP announce messages transmitted/received from another PTP device.
Sync	Number of synchronization messages transmitted/received from a master PTP device.
Followup	Number of follow-up messages transmitted/received from a 2-step-clock master PTP device.
Delay Req	Number of Delay Request messages transmitted/received from a slave device.
Delay Resp	Number of Delay Response messages sent to a slave device.
Mgmt	Number of PTP management messages transmitted/received by the modem.
Signal	Number of PTP signaling messages transmitted/received by the modem.
Discarded	<p>Total number of PTP packets discarded by the modem.</p> <p>Note: Some discarded messages are normal. For example, if the modem receives a PTP message while it is configuring its PTP port, it will discard that message.</p>



- 1) PTP Master Devices send Announce, Sync, Followup, and Delay Response messages, while PTP Slave Devices send Delay Request messages.**
- 2) PTP is a UDP multicast protocol. When negotiating with devices over the LAN interface, the modem uses UDP Port 319 for events, and UDP Port 320 for general packets. On the WAN interface, the modem uses UDP Port 59319 for events, and UDP Port 59320 for general packets.**

7.5.4.4.8 Status | Traffic Statistics | MAC Table

Use this page to view and refresh the MAC Addresses that the modem has discovered on one or more of its Ethernet switch ports.

MAC	DBNum	CPU	P4	P3	P2	P1	WAN	Type
00-06-b0-00-02-d7	0	1	0	0	0	0	0	Static
00-06-b0-02-c4-80	0	0	0	0	0	0	1	Dynamic
01-00-5e-00-01-81	0	1	0	0	1	0	0	Dynamic
01-00-5e-00-01-84	0	1	0	0	0	0	0	Dynamic
90-e2-ba-2b-a6-bb	0	0	0	0	0	1	0	Dynamic

Figure 7-45. Status | Traffic Statistics | MAC Table page

MAC Table

Click **[Refresh]** to update the page with the latest discovered MAC Addresses.

From left to right, note the following:

Column	Description
MAC	The MAC Address of the device on LAN/WAN
DBNum	Database number (always zero)
CPU	Port connected to the modem's M&C Management Port
P4	User Traffic Port #4
P3	User Traffic Port #3
P2	User Traffic Port #2
P1	User Traffic Port #1
WAN	Packets going into WAN (when the IP Packet Processor is installed and enabled)
Type	Identifies the MAC address as Static or Dynamic

7.5.4.4.9 Status | Traffic Statistics | Clear Counters

Use this page to clear and reset the counters for all Traffic Statistics pages (**Ethernet**, and when applicable, **Router**, **Managed Switch**, **WAN**, **Compression**, **QoS**, and **PTP**).

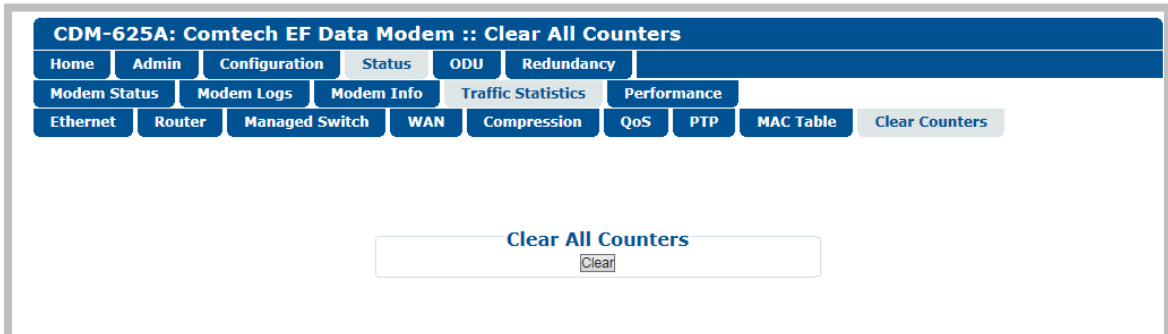

Figure 7-46. Status | Traffic Statistics | Clear Counters page

Clear All Counters

Click **[Clear]** to globally clear and reset the Traffic Statistics counters.

7.5.4.4.5 Status | Performance Pages



These pages are available only when you install and enable the optional IP Packet Processor card. See Sect. 7.5.3.1 for complete details about using these conditional access pages.

Click the **Performance** or **Graphs** tab to continue.

7.5.4.4.5.1 Status | Performance | Performance

Use this page to view a tabulated “snapshot” of the CDM-625A performance statistics.

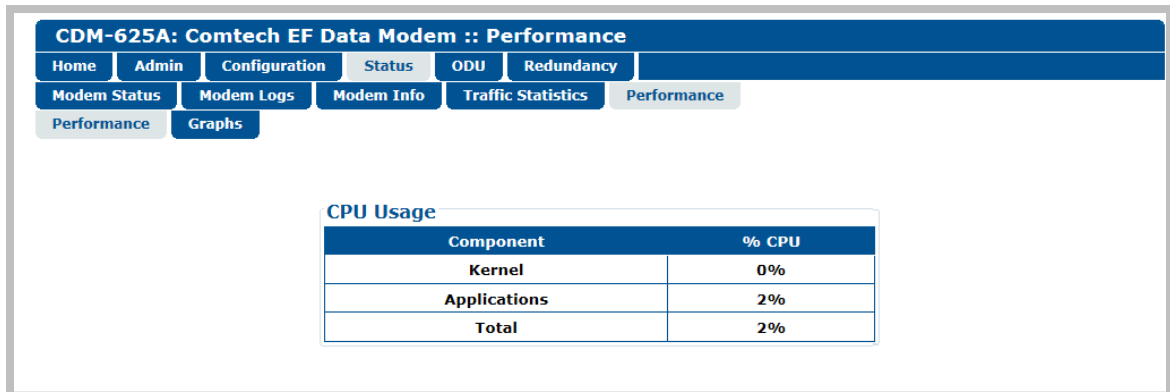

Figure 7-47. Status | Performance | Performance page

CPU Usage

Component	% CPU Description
Kernel	The percentage of CPU time used by the packet-processing components of the module.
Applications	The percentage of CPU time used by the management interfaces.
Total	Cumulative percentage of Kernel and Applications components.



At present, ‘CPU Usage (%)’ is the only viewable parameter. More functionality will be selectable in future firmware releases.

7.5.4.4.5.2 Status | Performance | Graphs

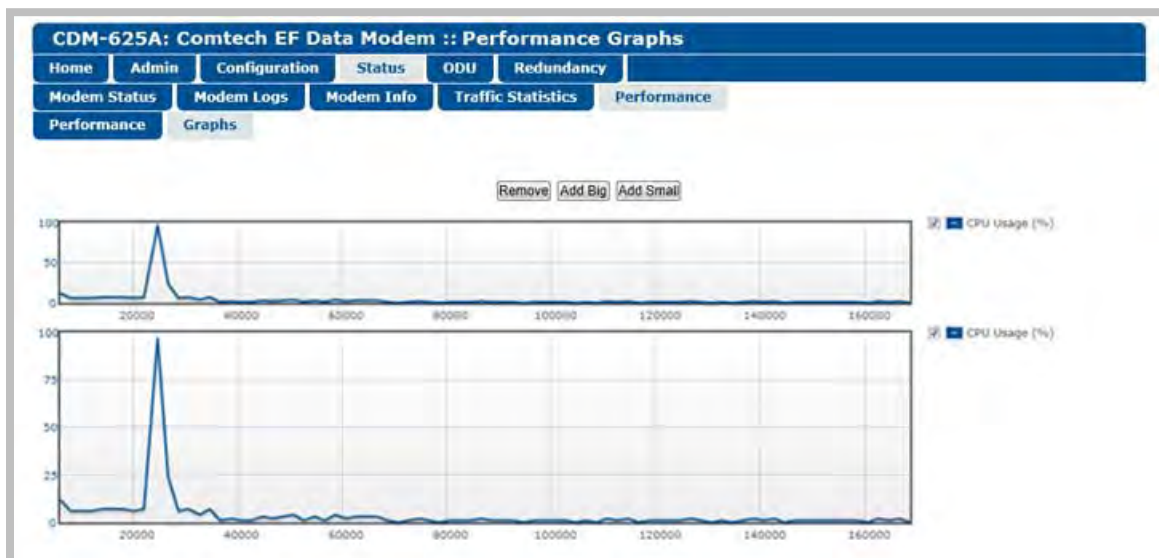

Figure 7-48. Status | Performance | Graphs page

Use this page to view a graphical representation of the CDM-625A performance. The displayed graphs automatically update in real time.

Typical for both line graph types, the X-axis denotes elapsed time; the Y-axis denotes performance, in percent. Either graph scrolls from right to left as viewing time increments.

Click **[Add Big]** to display a line graph with an extended scale Y-axis.

Click **[Add Small]** to display a line graph with a compressed scale Y-axis.

For either line graph, use the component check box, located to the right of each graph, to select that graph's viewable parameter. The line graph will update to incorporate performance tracking for that item.



At present, 'CPU Usage (%)' is the only selectable parameter; more functionality will be available in future firmware releases.

Each new graph is added to the bottom of the scrollable page. Any combination of graph types may be displayed on this page. Click **[Remove]** to delete the bottom-most graph from the page.

7.5.4.5 ODU (Outdoor Unit) Pages (Summary Only)



1) After enabling ODU Comms and configuring the CDM-625A for 70/140 MHz operation, you may use the 'ODU (Outdoor Unit)' pages to control and monitor the CSAT-5060 or KST-2000A/B Outdoor Unit that is connected via FSK to the CDM-625A.

2) The Comtech EF Data LPOD Amplifier / Block Up Converter is not supported by the CDM-625A HTTP (Web Server) Interface at this time.



See Chapter 10. CDM-625A ODU (TRANSCIVER, BUC, LNB) Operation for complete details on using the HTTP Interface for ODU operations.

The figure displays four overlapping screenshots of the CDM-625A web interface for ODU management. The top screenshot shows the 'ODU Comms' page with 'ODU Comms' set to 'ENABLE'. The second screenshot shows the 'KST-2000A/B Configuration' page with fields for Up Converter (Frequency: 14250.0 MHz, Attenuation: 20.0 dB, Output: Off) and Down Converter (Frequency: 11950.0 MHz, Attenuation: 00.0 dB, Rx Band: N/A). The third screenshot shows the 'CSAT-5060 Status' page with an 'ODU Selection' dropdown set to 'CSAT#1' and a table of maintenance parameters and ODU alarms. The bottom screenshot shows the 'KST-2000A/B Utilities' page with 'ODU Type' set to 'KST-2000B' and 'HPA Type' set to 'OEM-SSPA', followed by a table of component details.

Maintenance Parameters		ODU Alarms	
24V:	24.6 V	10MHz Reference:	06.0 V
20V:	23.0 V	Tx Synthesizer:	11.4 V
12V:	13.3 V	Tx IFLO:	10.8 V
10V:	00.0 V	Rx Synthesizer:	09.7 V
+5V:	5.6 V	Rx IFLO:	10.8 V
-5V:	-5.0 V	Tx Temperature:	26.0 °C
		Rx Temperature:	26.0 °C
		Fan Current:	568.0 mA
		External Reference:	
		Tx Synthesizer:	
		Tx IFLO:	
		Rx Synthesizer:	
		Rx IFLO:	
		Thermal Warning:	
		Thermal Shutdown:	
		FAN Current:	

Assembly Number	Serial Number	Firmware Number	Firmware Version
M&C	8816-1C	00000000	0303-1C
Up Converter	7210-1E	031573173	7085-1D
Down Converter	7206-1A	031583144	7087-1C
HPA	xxxx-xx	xxxxxxxx	xxxx-xx

Figure 7-49. ODU Page Examples (Enable, Config, Status, and Utilities)

7.5.4.6 Redundancy Page



Take note of the following redundant switch information, as it pertains to IP Packet Processor Redundancy:

- **1:1 Redundancy** is supported using either a CRS-170A L-Band 1:1 Redundancy Switch or a CRS-180 70/140 MHz 1:1 Redundancy Switch, and a user-provided, off-the-shelf Ethernet switch.
- **1:N Redundancy** is supported using a CRS-300 1:10 Redundancy Switch or a CRS-500 M:N Redundancy System in 1:N mode based on the following criteria:

Redundancy Device	Packet Processor	Terrestrial Interface	Mode
CRS-300	Disabled	Any	Any
CRS-500	Disabled	EIA-422/530, V.35, Sync EIA-232	Any
	Enabled	Ethernet	L3 or Bridge

- **Packet Processor Redundancy** is supported in both 1:1 and 1:N redundant configurations using the CRS-500 M:N Redundancy System.

Read your pertinent switch Installation and Operation Manuals for detailed information on using the CDM-625A in a redundancy configuration.

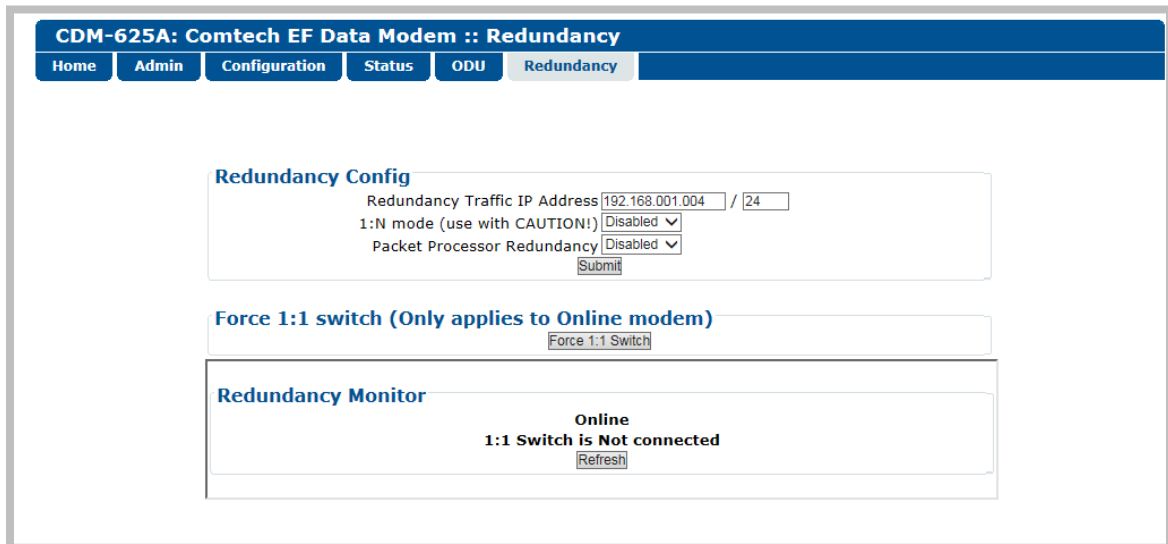

Figure 7-50. Redundancy page

Redundancy Config

- **Redundancy Traffic IP Address** – Enter the IP Address and subnet mask in the form XXX.XXX.XXX.XXX/YY.



The Redundancy Traffic IP Address and subnet mask is different from the Traffic/Management IP Address and subnet mask that is defined on the Configuration | LAN | IP page (Sect. 7.5.4.3.2.1).

- **1: N Mode (use with CAUTION!)** – Use the drop-down list to set 1:N Redundancy mode as **Disabled** or **Enabled**.
- **Packet Processor Redundancy** – When you **install** and **enable** the optional IP Packet Processor card in a 1:1 redundancy configuration (i.e., when you equip both the traffic and backup modems with the optional IP Packet Processor and you connect them to a CRS-170A L-Band or CRS-180 70/140 MHz 1:1 Redundancy Switch), there is no need to use the drop-down list here, as the modem **automatically** enables the IP Packet Processor Redundancy.

If it is desired to operate either modem outside of the redundant setup as a standalone unit, use the drop-down list to select Packet Processor Redundancy for that specific modem as **Disabled**.

Click **[Submit]** to save.

Force 1:1 switch (Only applies to Online modem)

When redundant modems are used and the selected unit is currently the *Online* unit, click **[Force 1:1 Switch]** to force a switchover so the unit will then be in *Offline* (standby) mode. The command is only valid for the *Online* unit in a 1:1 pair.

Redundancy Monitor

Monitoring of the redundancy setup – both the status of the active modem (i.e., *Online* or *Offline*) and the detected presence of a redundancy switch – is provided in this **read-only** section. Click **[Refresh]** to manually update this page section.

Chapter 8. SERIAL-BASED REMOTE PRODUCT MANAGEMENT

8.1 Overview

The CDM-625A Advanced Satellite Modem serial remote product management interface is an electrical interface that is either an EIA-485 multi-drop bus (for the control of multiple devices) or an EIA-232 connection (for the control of a single device). The interface transmits data in asynchronous serial form, using ASCII characters. This data consists of control and status information, transmitted in packets of variable length in accordance with the structure and protocol explained later in this appendix.

8.2 EIA-485

For applications where multiple devices are to be monitored and controlled, a full-duplex (or 4-wire plus ground) EIA-485 is preferred. Half-duplex (2-wire plus ground) EIA-485 is possible, but is not preferred. In full-duplex EIA-485 communication, there are two separate, isolated, independent, differential-mode twisted pairs, each handling serial data in different directions.

It is assumed that a 'Controller' device (a PC or dumb terminal) transmits data in a broadcast mode via one of the pairs. Multiple 'Target' devices are connected to this pair, and all simultaneously receive data from the Controller. The Controller is the only device with a line-driver connected to this pair – the Target devices have only line-receivers connected.

In the other direction, on the other pair each Target has a tri-state line driver connected, and the Controller has a line-receiver connected. All the line drivers are held in high-impedance mode until one (and only one) Target transmits back to the Controller. Each Target has a unique address, and each time the Controller transmits, the address of the intended recipient Target is included in a framed 'packet' of data. All of the Targets receive the packet, but only one (the intended) will reply. The Target enables its output line driver and transmits its return data packet back to the Controller in the other direction, on the physically separate pair.

EIA-485 (full duplex) summary:

- Two differential pairs – one pair for Controller-to-Target, one pair for Target-to-Controller.
- Controller-to-Target pair has one line driver (Controller), and all Targets have line-receivers.
- Target-to-Controller pair has one line receiver (Controller), and all Targets have Tri-State drivers.

8.3 EIA-232

This is a much simpler configuration in which the Controller device is connected directly to the Target via a two-wire-plus-ground connection. Controller-to-Target data is carried, via EIA-232 electrical levels on one conductor, and Target-to-Controller data is carried in the other direction on the other conductor.

8.4 Basic Protocol

Whether in EIA-232 or EIA-485 mode, all data is transmitted as asynchronous serial characters, suitable for transmission and reception by a Universal Asynchronous Receiver/Transmitter (UART). The asynchronous character format is 8-N-1 (8 data bits, no parity, 1 stop bit). The baud rate may vary from 1200 thru 57600 baud.

All data is transmitted in framed packets. The Controller is in charge of the process of monitor and control, and is the only device that is permitted to initiate, at will, the transmission of data. Targets are only permitted to transmit when they have been specifically instructed to do so by the Controller.

All bytes within a packet are printable ASCII characters, less than ASCII code 127. In this context, the Carriage Return and Line Feed characters are considered printable.

All messages from Controller-to-Target require a response, with one exception: This will be either to return data that has been requested by the Controller, or to acknowledge reception of an instruction to change the configuration of the Target. The exception to this is when the Controller broadcasts a message (such as Set Time/Date) using Address 0, when the Target is set to EIA-485 mode.

8.4.1 Packet Structure

The exchange of information is transmitted, Controller-to-Target and Target-to-Controller, in 'packets'. Each packet contains a finite number of bytes consisting of printable ASCII characters, excluding ASCII code 127 (DELETE).

In this context, the Carriage Return and Line Feed characters are considered printable. With one exception, all messages from Controller-to-Target require a response – this will be either to return data that has been requested by the Controller, or to acknowledge reception of an instruction to change the configuration of the Target.

Controller-to-Target						
Start of Packet	Target Address	Address Delimiter	Instruction Code	Code Qualifier	Optional Arguments	End of Packet
< ASCII code 60 (1 character)	(4 characters)	/ ASCII code 47 (1 character)	(3 characters)	= or ? ASCII codes 61 or 63 (1 character)	(n characters)	Carriage Return ASCII code 13 (1 character)

EXAMPLE: <0135/TFQ=70.2345{CR}

Target-to-Controller						
Start of Packet	Target Address	Address Delimiter	Instruction Code	Code Qualifier	Optional Arguments	End of Packet
> ASCII code 62 (1 character)	(4 characters)	/ ASCII code 47 (1 character)	(3 characters)	=, ?, !, or * ASCII codes 61, 63, 33, or 42 (1 character)	(From 0 thru n characters)	Carriage Return, Line Feed ASCII codes 13,10 (2 characters)

EXAMPLE: >0654/RSW=32{CR}{LF}

8.4.1.1 Start of Packet

- **Controller-to-Target:** This is the character '<' (ASCII code 60).
- **Target-to-Controller:** This is the character '>' (ASCII code 62).

The '<' and '>' characters indicate the start of packet. They may not appear anywhere else within the body of the message.

8.4.1.2 Target Address

Up to 9999 devices can be uniquely addressed. In EIA-232 applications this value is set to 0. In EIA-485 applications, the permissible range of values is 1 to 9999. It is programmed into a Target unit using the front panel keypad.



The Controller sends a packet with the address of a Target – the destination of the packet. When the Target responds, the address used is the same address, to indicate to the Controller the source of the packet. The Controller does not have its own address.

8.4.1.3 Address Delimiter

This is the “forward slash” character '/' (ASCII code 47).

8.4.1.4 Instruction Code

This is a three-character alphabetic sequence, which identifies the subject of the message. Wherever possible, the instruction codes have been chosen to have some significance – e.g., **TFQ** for transmit frequency, **RMD** for receive modulation type, etc. This aids in the readability of the message, should it be displayed in its raw ASCII form. Only upper case alphabetic characters may be used (A-Z, ASCII codes 65 - 90).

8.4.1.5 Instruction Code Qualifier

This is a single character, which further qualifies the preceding instruction code. Code Qualifiers obey the following rules:

- 1) **From Controller-to-Target**, the only permitted values are:

Symbol	Definition
= (ASCII code 61)	The '=' code is used as the Assignment Operator (AO) and is used to indicate that the parameter defined by the preceding byte should be set to the value of the argument (s) which follow it. EXAMPLE: In a message from Controller-to-Target, TFQ=0950.0000 would mean "set the transmit frequency to 950 MHz."
? (ASCII code 63)	The '?' code is used as the Query Operator (QO) and is used to indicate that the Target should return the current value of the parameters defined by the preceding byte. EXAMPLE: In a message from Controller-to-Target, TFQ? Would mean "return the current value of the transmit frequency."

- 2) **From Target-to-Controller**, the only permitted values are:

Symbol	Definition
= (ASCII code 61)	The '=' code is used in two ways: a. If the Controller has sent a query code to a Target. (EXAMPLE: TFQ? (meaning 'what's the Transmit frequency?'), the Target would respond with TFQ=xxxx.xxxx , where xxxx.xxxx represents the frequency in question. b. If the Controller sends an instruction to set a parameter to a particular value, then, providing the value sent is valid, the Target will acknowledge the message by replying with TFQ= (with no message arguments).
? (ASCII code 63)	If the Controller sends an instruction to set a parameter to a particular value, then, if the value sent is not valid, the Target will acknowledge the message by replying (for example) with TFQ? (with no message arguments). This indicates that there was an error in the message sent by the Controller.
! (ASCII code 33)	If the Controller sends an instruction code which the Target does not recognize, the Target will acknowledge the message by echoing the invalid instruction, followed by the ! character. EXAMPLE: XYZ!
* (ASCII code 42)	If the Controller sends an instruction to set a parameter to a particular value, then, if the value sent is valid BUT the modulator will not permit that particular parameter to be changed at this time, the Target will acknowledge the message by replying, for example, with TFQ* (with message arguments).

# (ASCII code 35)	If the Controller sends a correctly formatted command BUT the modem is in local mode, it will not allow reconfiguration and will respond with TFQ#
~ (ASCII code 126)	If a message was sent via a local modem to a distant end device or ODU, the message was transmitted transparently through the local modem. In the event of the distant-end device not responding, the local modem would generate a response. EXAMPLE: 0001/RET~ (indicating that it had finished waiting for a response and was now ready for further comms).
^ (ASCII code 94)	If the Controller sends a correctly formatted command BUT the modem is in Ethernet Remote mode, it will not allow reconfiguration, and will respond with TFQ^ .

8.4.1.6 Optional Message Arguments

Arguments are not required for all messages. Arguments are ASCII codes for the characters 0 thru 9 (ASCII codes 48 to 57), period (ASCII code 46) and comma (ASCII code 44).

8.4.1.7 End Of Packet

- **Controller-to-Target:** This is the 'Carriage Return' character (ASCII code 13).
- **Target-to-Controller:** This is the two-character sequence 'Carriage Return', 'Line Feed' (ASCII codes 13 and 10). Both indicate the valid termination of a packet.

8.5 Remote Commands and Queries

8.5.1 Table Indexes

NOTES:

1) **Index Columns** – Where Column ‘C’=Command, and Column ‘Q’=Query, columns marked ‘X’ designate the instruction code as *Command only, Query only, or Command or Query*. Where **CODE=XXX**, this indicates a priority command.

2) **In the tables that follow, the following codes are used in the ‘Response to Command’ column (per Sect. 8.5.5):**

- = Message ok
- ? Received ok, but invalid arguments were found.
- ^ Message ok, but unit is in **Ethernet** mode.
- # Message ok, but unit is not in **Remote** mode.
- ~ Time out of a pass-through message, either to via EDMAC or to a local ODU.

Sect. 8.5.2 Tx Parameters

CODE	C	Q	PAGE
APP	X	X	8-15
AUP	X	X	8-15
DTS	X	X	8-17
DTY	X	X	8-17
PLI		X	8-16
REB		X	8-16

CODE	C	Q	PAGE
TBA	X	X	8-17
TCI	X	X	8-16
TCK	X	X	8-16
TCR	X	X	8-11
TDI	X	X	8-13
TDR	X	X	8-13
TET	X	X	8-17
TFM	X	X	8-10

CODE	C	Q	PAGE
TFQ	X	X	8-13
TFT	X	X	8-11
TIR		X	8-17
TIT	X	X	8-10
TLO	X	X	8-17
TMD	X	X	8-11
TMI		X	8-18
TMR	X	X	8-14

CODE	C	Q	PAGE
TMX	X	X	8-13
TPL	X	X	8-14
TRS	X	X	8-14
TSC	X	X	8-14
TSI	X	X	8-14
TSR	X	X	8-13
TTA	X	X	8-16
TTC	X	X	8-17

CODE	C	Q	PAGE
TTF		X	8-17
TVL	X	X	8-16
TXA	X	X	8-15
TXO	X	X	8-15

Sect. 8.5.3 Rx Parameters

CODE	C	Q	PAGE
EBA	X	X	8-24
ITS	X	X	8-25
ITY	X	X	8-24
RBA	X	X	8-25
RBS	X	X	8-24
RCB	X		8-25

CODE	C	Q	PAGE
RCI	X	X	8-24
RCK	X	X	8-24
RCR	X	X	8-20
RDI	X	X5	8-22
RDR	X	X	8-22
RDS	X	X	8-23
REE	X	X	8-25
RET	X	X	8-25

CODE	C	Q	PAGE
RFM	X	X	8-19
RFQ	X	X	8-22
RFT	X	X	8-20
RIR		X	8-25
RIT	X	X	8-19
RLO	X	X	8-25
RMD	X	X	8-20
RMI		X	8-26

CODE	C	Q	PAGE
RMR	X	X	8-23
RMX	X	X	8-22
RRS	X	X	8-23
RSI	X	X	8-23
RSR	X	X	8-22
RSW	X	X	8-23
RTC	X	X	8-24
RTE	X	X	8-24

CODE	C	Q	PAGE
RTF		X	8-25
RVL	X	X	8-24

Sect. 8.5.4 Unit Parameters

CODE	C	Q	PAGE
ABA	X	X	8-30
ACM	X	X	8-38
ADJ	X	X	8-29
AHD	X	X	8-39
AHM	X	X	8-38
AHO	X	X	8-38
AHT	X	X	8-38
ALA	X	X	8-30
BKE	X	X	8-36
BRE		X	8-37
BRM	X		8-37
BRR		X	8-37
BRX	X	X	8-36
BTX	X	X	8-36
CAE	X		8-31
CAI	X	X	8-37

CODE	C	Q	PAGE
CAS	X		8-33
CCF	X	X	8-35
CEX	X	X	8-36
CID	X	X	8-27
CNM	X	X	8-35
CPM	X	X	8-35
CSD	X	X	8-35
CST	X		8-41
CTD	X	X	8-29
DAY	X	X	8-27
DMM	X	X	8-38
DMT		X	8-37
EFM	X	X	8-28
EFR	X	X	8-29
EMU	X	X	8-27
ESA	X	X	8-28
ESC	X	X	8-28

CODE	C	Q	PAGE
FPL	X	X	8-27
FRB	X	X	8-37
FSW	X		8-33
HHC	X	X	8-34
IEP	X		8-31
IMG	X	X	8-27
IPA	X	X	8-33
IPG	X	X	8-34
IPT	X	X	8-34
ISP	X		8-33
LAT	X	X	8-39
LNG	X	X	8-40
LRS	X	X	8-27
MAC		X	8-34
MEO	X	X	8-38
MRC	X	X	8-27
MSG	X	X	8-39
MSK	X	X	8-30

CODE	C	Q	PAGE
NUE		X	8-30
NUS		X	8-31
ODU	X	X	8-33
OFN	X	X	8-33
OTO	X	X	8-29
PCO	X	X	8-34
PHN	X	X	8-39
PMD	X	X	8-42
PME	X	X	8-41
PMI	X	X	8-42
PMS	X	X	8-41
PTS	X	X	8-41
PTU	X	X	8-41
PTY	X	X	8-41
RAA	X	X	8-39
RAB	X	X	8-40
RAE	X	X	8-39
RAP	X	X	8-40

CODE	C	Q	PAGE
RAS	X	X	8-41
RAT	X	X	8-41
RBP	X	X	8-37
RNE		X	8-30
RNN		X	8-32
RNS		X	8-31
RTS	X	X	8-34
SCP	X	X	8-28
SSI	X	X	8-31
TBP	X	X	8-36
TIM	X	X	8-27
TPB	X	X	8-39
TPE	X	X	8-38
TPS	X	X	8-38
TPZ	X	X	8-42
TST	X	X	8-29
WRM	X	X	8-29

Sect. 8.5.5 Bulk Configuration Strings

CODE	C	Q	PAGE
BSQ		X	8-48

CODE	C	Q	PAGE
CLD	X		8-47
CST	X		8-47

CODE	C	Q	PAGE
DIC	X	X	8-46
DNI	X	X	8-46

CODE	C	Q	PAGE
MGC	X	X	8-43
OGC	X	X	8-45

CODE	C	Q	PAGE
QDI	X	X	8-47

Sect. 8.5.6 Modem Information

CODE	C	Q	PAGE
EID		X	8-50
FCC		X	8-49

CODE	C	Q	PAGE
FCF		X	8-49
FRW		X	8-49

CODE	C	Q	PAGE
HRV		X	8-49

CODE	C	Q	PAGE
SNO		X	8-49

CODE	C	Q	PAGE
SW2		X	8-49
SWR		X	8-49

Sect. 8.5.7 Modem Performance Information

CODE	C	Q	PAGE
ABE		X	8-56
ABR	X		8-57
AFE		X	8-57
AFR	X		8-57
AHS	X	X	8-58
APC	X		8-57

CODE	C	Q	PAGE
APL	X	X	8-58
APS		X	8-57
BER		X	8-53
BFS		X	8-53
CPR		X	8-56
CRM		X	8-56

CODE	C	Q	PAGE
CDM		X	8-56
CFM		X	8-56
EBN		X	8-53
FLT		X	8-54
OUS		X	8-54

CODE	C	Q	PAGE
PSD		X	8-56
RBE		X	8-58
RED		X	8-53
RFO		X	8-53
RSL		X	8-53
RSN		X	8-58

CODE	C	Q	PAGE
SNR		X	8-58
TMP		X	8-53

Sect. 8.5.8 BUC Parameters (L-Band Device)

CODE	C	Q	PAGE
BAD	X	X	8-59
BCH	X	X	8-59
BCL	X	X	8-59

CODE	C	Q	PAGE
BDC		X	8-59
BDV		X	8-59
BFR	X	X	8-59

CODE	C	Q	PAGE
BOE	X	X	8-59
BOL		X	8-59
BPA		X	8-60
BPC		X	8-60

CODE	C	Q	PAGE
BPS	X	X	8-59
BSV		X	8-60
BUT		X	8-60

CODE	C	Q	PAGE

Sect. 8.5.9 LNB Parameters (L-Band Device)

CODE	C	Q	PAGE
LNC		X	8-61
LNH	X	X	8-61

CODE	C	Q	PAGE
LNL	X	X	8-61
LNR	X	X	8-61

CODE	C	Q	PAGE
LPS	X	X	8-61
LVO		X	8-61

CODE	C	Q	PAGE

CODE	C	Q	PAGE

Sect. 8.5.10 Ethernet Parameters

CODE	C	Q	PAGE
ACL	X	X	8-65
AFI		X	8-66
DMP	X	X	8-65
EFS	X	X	8-65
EGC	X	X	8-62

CODE	C	Q	PAGE
NPS		X	8-62
PPE	X	X	8-64
PRD	X	X	8-65
PTM	X	X	8-65
PTP	X	X	8-65

CODE	C	Q	PAGE
QOS	X	X	8-64
SEC	X	X	8-62
SML	X	X	8-63
SMV	X	X	8-63
SPC	X	X	8-64
SVA	X	X	8-63

CODE	C	Q	PAGE
SVD	X		8-63
SVE	X		8-64
SVM	X	X	8-63
SVT	X	X	8-63

CODE	C	Q	PAGE
VS0		X	8-65
VS1		X	8-65
VS2		X	8-66
WBF		X	8-63
WBL	X	X	8-63
WMD	X	X	8-64

8.5.2 Tx Parameters

Priority System: TIT (Highest priority) , TFM, TFT, TMD, TCR, TDR, and TSR (Lowest Priority), indicated by **shading**. Any change to a higher priority parameter can override any of the parameters of lower priority.

Exception – Select DROP, D&I++, QDI or Framed QDI mode using TFM (Transmit Framing type), which is highest priority.

Parameter Type	Command (Instruction & Qualifier)	Number of Arguments	Description of Arguments	Response to Command	Query (Instruction & Qualifier)	Response to Query
Tx Interface Type	TIT=	1 byte, 0 thru 9 or A	Command or Query. Sets or returns Tx Interface Type in the form x, where: 0=RS422 1=V.35 2= reserved – do not use. 3=Balanced G.703 4=Unbalanced G.703 5=Audio (Data rate fixed at 64 kbps) (IBS/EDMAC only) 6=LVDS 7=HSSI 8=IP 9=ASI A=IP-ACM (Unframed, EDMACs only) B=VersaFEC-2 ACM (requires VFEC-2 option card and VFEC-2 ACM FAST option) EXAMPLE: <0/TIT=1 (selects V.35)	TIT= TIT? TIT* TIT#	TIT?	TIT=x (see Description of Arguments)
Tx Framing Mode	TFM=	1 byte, 0 thru 9 or A	Command or Query. Sets or returns Tx Framing Mode in the form x, where: 0=Unframed 1=IBS 2=IDR 3=D&I - DROP (requires D&I FAST option) 4=EDMAC 5=D&I++ (requires D&I FAST option) 6=ESC++ 7=EDMAC-2 8=Quad Drop & Insert (requires QDI FAST option) (G.703 Balanced, E1-CCS only) 9=Framed QDI (requires QDI FAST option)(G.703 Balanced, E1-CCS only) A=EDMAC-3 EXAMPLE: <0/TFM=0 (selects Unframed mode)	TFM= TFM? TFM* TFM#	TFM?	TFM=x (see Description of Arguments)

Parameter Type	Command (Instruction & Qualifier)	Number of Arguments	Description of Arguments	Response to Command	Query (Instruction & Qualifier)	Response to Query
Tx FEC Type	TFT=	1 byte, 0 thru 9, A thru D	<p>Command or Query. Sets or returns Tx FEC Coding Type in the form x, where:</p> <ul style="list-style-type: none"> 0=None (uncoded) with differential encoding ON 1=Viterbi 2=Viterbi + Reed-Solomon 3=Sequential 4=Sequential + Reed-Solomon 5=TCM (Trellis Code Modulation) (Forces Rate 2/3) 6=TCM + Reed-Solomon (Forces Rate 2/3) 7=TPC (aka Turbo) (requires TPC/LDPC Codec) 8=None (uncoded) with differential encoding OFF 9=LDPC (Requires TPC/LDPC Codec) <ul style="list-style-type: none"> A=VersaFEC CCM or ACM (fixed in IP-ACM) B=VersaFEC ULL C=VersaFEC-2 Long Block D=VersaFEC-2 Short Block <p>EXAMPLE: <0/TFT=1 (selects Viterbi coding)</p>	TFT= TFT? TFT* TFT#	TFT?	TFT=x (see Description of Arguments)
Tx Modulation Type	TMD=	1 byte, 0 thru 8	<p>Command or Query (Query only in ACM). Sets or returns Tx Modulation Type in the form x, where:</p> <ul style="list-style-type: none"> 0=BPSK 1=QPSK 2=QPSK 3=8-PSK 4=16-QAM (Turbo or Viterbi + RS only) 5=8-QAM (TPC/LDPC only) (Need Codec & FAST option) 6=8-ARY (VersaFEC-2 only) 7=16-ARY (VersaFEC-2 only) 8=32-ARY (VersaFEC-2 only) <p>Depending on FEC type, not all of these selections will be valid. EXAMPLE: <0/TMD=2 (selects QPSK)</p>	TMD= TMD? TMD* TMD#	TMD?	TMD=x (see Description of Arguments)
Tx FEC Code Rate	TCR=	1 byte, 0 thru 7, A thru Z, a thru z, ", &, @, [,], {, }	<p>Command or Query (Query only in ACM). Sets or returns Tx FEC Code Rate in the form x, where:</p> <ul style="list-style-type: none"> 0=Rate 1/2 1=Rate 3/4 2=Rate 7/8 3=Rate 2/3 (8-PSK TCM or LDPC only) 4=Rate 1/1 (Uncoded or No FEC) 5=Rate 21/44 (Turbo Only) 6=Rate 5/16 (Turbo Only) 7=Rate 0.95 (Turbo Only) (aka 17/18) 8=Reserved 9=Reserved A=VersaFEC CCM ModCod 0 – BPSK 0.488 B=VersaFEC CCM ModCod 1 – QPSK 0.533 C=VersaFEC CCM ModCod 2 – QPSK 0.631 D=VersaFEC CCM ModCod 3 – QPSK 0.706 	TCR= TCR? TCR* TCR#	TCR?	TCR=x (see Description of Arguments)

Parameter Type	Command (Instruction & Qualifier)	Number of Arguments	Description of Arguments	Response to Command	Query (Instruction & Qualifier)	Response to Query
...Tx FEC Code Rate (cont.)			E=VersaFEC CCM ModCod 4 – QPSK 0.803 F=VersaFEC CCM ModCod 5 – 8-QAM 0.642 G=VersaFEC CCM ModCod 6 – 8-QAM 0.711 H=VersaFEC CCM ModCod 7 – 8-QAM 0.780 I=VersaFEC CCM ModCod 8 – 16-QAM 0.731 J=VersaFEC CCM ModCod 9 – 16-QAM 0.780 K=VersaFEC CCM ModCod 10 – 16-QAM 0.829 L=VersaFEC CCM ModCod 11 – 16-QAM 0.853 M=Reserved N=Reserved O=VersaFEC CCM ModCod 14 – 8-QAM 0.576 P=VersaFEC CCM ModCod 15 – 16-QAM 0.644 Q=Reserved R=VersaFEC CCM ULL ModCod 17 – BPSK 0.493 S=VersaFEC CCM ULL ModCod 18 – QPSK 0.493 T=VersaFEC CCM ULL ModCod 19 – QPSK 0.654 U=VersaFEC CCM ULL ModCod 20 – QPSK 0.734 V=VersaFEC-2 ModCod 0 – BPSK 0.489 W=VersaFEC-2 ModCod 1 – QPSK 0.489 X=VersaFEC-2 ModCod 2 – QPSK 0.537 Y=VersaFEC-2 ModCod 3 – QPSK 0.586 Z=VersaFEC-2 ModCod 4 – QPSK 0.611 a=VersaFEC-2 ModCod 5 – QPSK 0.635 b=VersaFEC-2 ModCod 6 – QPSK 0.660 c=VersaFEC-2 ModCod 7 – QPSK 0.684 d=VersaFEC-2 ModCod 8 – QPSK 0.733 e=VersaFEC-2 ModCod 9 – 8-ARY 0.521 f=VersaFEC-2 ModCod 10 – 8-ARY 0.537 g=VersaFEC-2 ModCod 11 – 8-ARY 0.562 h=VersaFEC-2 ModCod 12 – 8-ARY 0.586 i=VersaFEC-2 ModCod 13 – 8-ARY 0.611 j=VersaFEC-2 ModCod 14 – 8-ARY 0.635 k=VersaFEC-2 ModCod 15 – 8-ARY 0.660 l=VersaFEC-2 ModCod 16 – 8-ARY 0.684 m=VersaFEC-2 ModCod 17 – 8-ARY 0.708 n=VersaFEC-2 ModCod 18 – 8-ARY 0.733 o=VersaFEC-2 ModCod 19 – 16-ARY 0.586 p=VersaFEC-2 ModCod 20 – 16-ARY 0.611 q=VersaFEC-2 ModCod 21 – 16-ARY 0.635 r=VersaFEC-2 ModCod 22 – 16-ARY 0.660 s=VersaFEC-2 ModCod 23 – 16-ARY 0.684 t=VersaFEC-2 ModCod 24 – 16-ARY 0.708 u=VersaFEC-2 ModCod 25 – 16-ARY 0.733 v=VersaFEC-2 ModCod 26 – 16-ARY 0.757 w=VersaFEC-2 ModCod 27 – 16-ARY 0.782 x=VersaFEC-2 ModCod 28 – 32-ARY 0.660			

Parameter Type	Command (Instruction & Qualifier)	Number of Arguments	Description of Arguments	Response to Command	Query (Instruction & Qualifier)	Response to Query
...Tx FEC Code Rate (cont)			<p>y=VersaFEC-2 ModCod 29 – 32-ARY 0.684 z=VersaFEC-2 ModCod 30 – 32-ARY 0.708 "=VersaFEC-2 ModCod 31 – 32-ARY 0.733 &=VersaFEC-2 ModCod 32 – 32-ARY 0.757 @=VersaFEC-2 ModCod 33 – 32-ARY 0.782 [=VersaFEC-2 ModCod 34 – 32-ARY 0.801]=VersaFEC-2 ModCod 35 – 32-ARY 0.831 {=VersaFEC-2 ModCod 36 – 32-ARY 0.855 (Long Block only) }=VersaFEC-2 ModCod 37 – 32-ARY 0.879 (Long Block only)</p> <p>Depending on FEC type, not all of these selections will be valid. EXAMPLE: <0/TCR=1 (selects Rate 3/4)</p>			
Tx Data Rate	TDR=	9 bytes	<p>Command or Query (Query only in ACM). Sets or returns Tx Data rate in the form xxxxx.xxx, where: xxxxx.xxx=Value, in kbps, from 18 kbps to 25 Mbps Resolution=1 bps NOTES: 1) Additional auxiliary G.703 sub-rates are available, selected using: 00512.AUX 01024.AUX 02048.AUX 2) The connectors used for the Aux rates are IDI/DDO. 3) These Aux rates are not available with Drop & Insert or IDR. 4) Read-only if Framing Mode is Quad Drop & Insert (TFM=8). Data rate is set by assigning the number of channels on each port. 5) Read-only if Modulation Type is a 'Reserved' type EXAMPLE: <0/TDR=02047.999 (selects 2047.999 kbps)</p>	TDR= TDR? TDR* TDR#	TDR?	TDR=xxxxx.xxx (see Description of Arguments)
Tx Symbol Rate	TSR=	9 bytes, numeric	<p>Query only (Command or Query in IP-ACM or VersaFEC-2 ACM). Allows remote access to the Tx symbol rate in the form dddddddd. NOTE: Symbol Rate range in IP-ACM is from 37 ksym/sec to 4100 ksym/sec Symbol Rate ranges in VersaFEC-2 ACM Short Block is from 37 ksym/sec to 1000 ksym/sec Symbol Rate ranges in VersaFEC-2 ACM Long Block is from 37 ksym/sec to 125000 ksym/sec</p>	TSR? TSR= TSR* TSR#	TSR?	TSR=ddddddddd (see Description of Arguments)
Tx Frequency	TFQ=	9 bytes Exception – 600 Emulation 8 bytes	<p>Command or Query. Sets or returns Tx Frequency in the form xxxx.xxxx, where: 70/140 Unit range is from 50 MHz to 180 MHz, and L-Band Unit (FAST Option) range is from 950 MHz to 2250 MHz Resolution=100Hz. EXAMPLE: <0/TFQ=0950.9872</p>	TFQ= TFQ? TFQ* TFQ#	TFQ?	TFQ=xxxx.xxxx Exception – 600 Emulation: TFQ=xxx.xxxx
Tx Data Invert	TDI= Exception – 600/L Emulation: ITD=	1 byte, 0 or 1	<p>Command or Query. Sets or returns Invert Transmit Data in the form x, where: 0=Normal 1=Inverted EXAMPLE: <0/TDI=1 (selects TX Data Invert)</p>	TDI= TDI? TDI* TDI#	TDI? Exception – 600/L Emulation: ITD?	TDI=x (see Description of Arguments)
Tx Sub-Mux on/off	TMX=	1 byte, 0 or 1	<p>Command or Query. Sets or returns Tx Sub-Mux in the form x, where: 0=Off 1=On</p>	TMX? TMX= TMX* TMX#	TMX?	TMX=x (see Description of Arguments)

Parameter Type	Command (Instruction & Qualifier)	Number of Arguments	Description of Arguments	Response to Command	Query (Instruction & Qualifier)	Response to Query																																				
Tx Sub-Mux Ratio	TMR=	2 bytes, numeric	<p>Command or Query.</p> <p>Sets or returns Tx Sub-Mux Ratio (IP/Synchronous Interface) in the form xx, where</p> <table border="0"> <tr> <td>00=1/9</td> <td>09=3/7</td> <td>18=3/2</td> <td>27=6/1</td> </tr> <tr> <td>01=1/8</td> <td>10=1/2</td> <td>19=5/3</td> <td>28=7/1</td> </tr> <tr> <td>02=1/7</td> <td>11=3/5</td> <td>20=2/1</td> <td>29=8/1</td> </tr> <tr> <td>03=1/6</td> <td>12=2/3</td> <td>21=7/3</td> <td>30=9/1</td> </tr> <tr> <td>04=1/5</td> <td>13=3/4</td> <td>22=5/2</td> <td>31=1/59</td> </tr> <tr> <td>05=1/4</td> <td>14=4/5</td> <td>23=3/1</td> <td>32=1/39</td> </tr> <tr> <td>06=2/7</td> <td>15=1/1</td> <td>24=7/2</td> <td>33=1/19</td> </tr> <tr> <td>07=1/3</td> <td>16=5/4</td> <td>25=4/1</td> <td></td> </tr> <tr> <td>08=2/5</td> <td>17=4/3</td> <td>26=5/1</td> <td></td> </tr> </table> <p>EXAMPLE: <0/TMR=01 (Selects ratio 1/8)</p>	00=1/9	09=3/7	18=3/2	27=6/1	01=1/8	10=1/2	19=5/3	28=7/1	02=1/7	11=3/5	20=2/1	29=8/1	03=1/6	12=2/3	21=7/3	30=9/1	04=1/5	13=3/4	22=5/2	31=1/59	05=1/4	14=4/5	23=3/1	32=1/39	06=2/7	15=1/1	24=7/2	33=1/19	07=1/3	16=5/4	25=4/1		08=2/5	17=4/3	26=5/1		TMR? TMR= TMR* TMR#	TMR?	TMR=xx (see Description of Arguments)
00=1/9	09=3/7	18=3/2	27=6/1																																							
01=1/8	10=1/2	19=5/3	28=7/1																																							
02=1/7	11=3/5	20=2/1	29=8/1																																							
03=1/6	12=2/3	21=7/3	30=9/1																																							
04=1/5	13=3/4	22=5/2	31=1/59																																							
05=1/4	14=4/5	23=3/1	32=1/39																																							
06=2/7	15=1/1	24=7/2	33=1/19																																							
07=1/3	16=5/4	25=4/1																																								
08=2/5	17=4/3	26=5/1																																								
Tx Reed-Solomon Encoding	TRS=	1 byte, 0 thru 3	<p>Command or Query.</p> <p>Sets or returns Tx RS encoding in the form x, where:</p> <p>0=Normal (based on the Open Network framing selected)</p> <p>1=IESS-310 mode, valid with QDI, unframed, IBS, D&I, IDR.</p> <p>2=EF Data legacy standard (225,205) – unframed, QDI only</p> <p>3=IBS (126,112) – unframed only</p> <p>EXAMPLE: <0/TRS=0 (This is a 'don't care' if no RS is selected under FEC Type)</p> <p>Available all framing modes, except EDMAC.</p>	TRS= TRS? TRS* TRS#	TRS?	TRS=x (see Description of Arguments)																																				
Tx Spectrum Invert	TSI=	1 byte, 0 or 1	<p>Command or Query.</p> <p>Sets or returns Tx Spectrum Invert selection in the form x, where:</p> <p>0=Normal</p> <p>1=Tx Spectrum Inverted</p> <p>EXAMPLE:TSI=0 (selects normal)</p>	TSI= TSI? TSI* TSI#	TSI?	TSI=x (see Description of Arguments)																																				
Tx Scrambler	TSC=	1 byte, 0 thru 2	<p>Command or Query.</p> <p>Sets or returns Tx Scrambler State in the form x, where:</p> <p>0=Off</p> <p>1=Normal</p> <p>2=IESS-315</p> <p>NOTE: When CnC mode is ON, Tx Scrambler state is fixed as IESS-315.</p> <p>EXAMPLE: <0/TSC=1 (Scrambler On)</p>	TSC= TSC? TSC* TSC#	TSC?	TSC=x (see Description of Arguments)																																				
Tx Power Level	TPL=	4 bytes	<p>Command or Query.</p> <p>Sets or returns Tx Output power level in the form xx.x, where:</p> <p>Level=Value from 00 thru -40 dBm (minus sign assumed) for 950 or 1950MHz range.</p> <p>Level=Value from 00 thru -25 dBm (minus sign assumed) for 50 or 180MHz range.</p> <p>EXAMPLE: <0/TPL=13.4</p> <p>NOTE: In AUPC mode, command is not valid. Response will be TPL*.</p> <p>When APC is active, query returns "TPL=99.9"; when command is not valid, response will be TPL*.</p> <p>When the external 20 dB attenuator is activated (via AUP), the permitted power level range shifted down by 20dB.</p> <p>EXAMPLE: -65 and -20 dBm.</p> <p>600 Emulation: Level range is from 00 thru -20 dBm (minus sign assumed).</p> <p>600L Emulation: Level range is from 00 thru -45 dBm (minus sign assumed).</p>	TPL= TPL? TPL* TPL#	TPL?	TPL=xx.x (see Description of Arguments)																																				

Parameter Type	Command (Instruction & Qualifier)	Number of Arguments	Description of Arguments	Response to Command	Query (Instruction & Qualifier)	Response to Query
Tx Carrier State	TXO=	1 byte, 0 thru 9	<p>Command or Query.</p> <p>Sets or returns Tx Carrier State in the form x, where:</p> <ul style="list-style-type: none"> 0=OFF due to front panel or remote control command 1=ON 2=RTI (receive/transmit inhibit), timeout=10 seconds 3=OFF due to ext H/W Tx Carrier- Off control * 4=OFF due to BUC or High-Stability Ref warm-up * 5=Carrier controlled by STDMA Controller * 6=RTI (receive/transmit inhibit), timeout=1 second 7=RTI (receive/transmit inhibit), timeout=2 seconds 8=RTI (receive/transmit inhibit), timeout=4 seconds 9=RTI (receive/transmit inhibit), timeout=7 seconds <p>NOTE: Arguments indicated with a * are status-only. They are not valid as a command, and are not indicated in MGC? response.</p> <p>EXAMPLE: <0/TXO=1 (Tx Carrier ON)</p>	TXO= TXO? TXO* TXO#	TXO?	TXO=x (see Description of Arguments)
Tx Alpha	TXA=	1 byte, 0 thru 5	<p>Command or Query.</p> <p>Sets or returns Tx Alpha Filter Rolloff Factor in the form x, where:</p> <ul style="list-style-type: none"> 0=0.35 1=0.25 2=0.20 3=0.15 4=0.10 5=0.05 <p>EXAMPLE: <0/TXA=0 (Tx filter rolloff factor is 0.35)</p>	TXA= TXA? TXA#	TXA?	TXA=x (see Description of Arguments)
Power Level Mode (was AUPC Enable)	AUP=	1 byte, 0 thru 3	<p>Command or Query.</p> <p>Sets or returns Power Level Mode in the form x, where:</p> <ul style="list-style-type: none"> 0=MANUAL mode (AUPC disabled) – Normal power mode 1=AUPC enabled. 2=MANUAL-LOW – Low power mode (-65 to -20dBm) - external attenuator activated. 3=AUPC-LOW – AUPC enabled and external attenuator activated <p>EXAMPLE: <0/AUP=1 (AUPC Enabled)</p> <p>NOTES:</p> <ol style="list-style-type: none"> 1) EDMAC or D&I++, E1 D&I w/ccs or ESC++ framing must be selected for the AUPC feature to be available. 2) External 20dB Attenuator is a hardware option. 	AUP= AUP? AUP* AUP#	AUP?	AUP=x (see Description of Arguments)
AUPC Parameters	APP=	6 bytes	<p>Command or Query.</p> <p>Sets or returns AUPC operating parameters in the form abc.cd, where:</p> <ul style="list-style-type: none"> a=Action on max. power condition: (0=do nothing, 1=generate Tx alarm) b=Action on remote demod unlock: (0=go to nominal power, 1=go to max power) c.c=Target Eb/No value, in dB, for remote demod from 0.0 thru 14.9: Numbers above 9.9 use hex representation for the first character, i.e. 14.9 is coded as E.9. d =Max increase in Tx Power permitted, in dB, from 0.0 thru 9.0 <p>EXAMPLE: <0/APP=015.67 (Sets no alarm, max power, 5.6 dB Target and 7 dB power increase.)</p>	APP= APP? APP* APP#	APP?	APP=abc.cd (see Description of Arguments)

Parameter Type	Command (Instruction & Qualifier)	Number of Arguments	Description of Arguments	Response to Command	Query (Instruction & Qualifier)	Response to Query
...AUPC Parameters (cont.)			<p>In IP-ACM mode or VersaFEC-2 ACM mode:</p> <p>a=Action on max. power condition: (0=do nothing, 1=generate Tx alarm when max power is reached, 2=generate Tx alarm when minimum ModCod is reached)</p> <p>b=Action on remote demod unlock: (0=go to nominal power, 1=go to max power, 2=hold)</p> <p>c.c=Max increase in Tx Power permitted, from 0.0 thru 9.9 dB OR when CnC mode is on, from 0.0 thru 6.0 dB</p> <p>d=Mode (0=Normal, 1=+/- Track), read-only</p>			
Remote Eb/No	N/A	4 bytes	<p>Query only.</p> <p>Returns the value of Eb/No of the remote demod in the form xx.x, where: xx.x=02.0 or 16.0</p> <p>Responds 99.9=remote demod unlocked.</p> <p>Responds xx.x if EDMAC is disabled.</p> <p>EXAMPLE: <0/REB? >0/REB=12.4</p> <p>NOTE: For values > 16.0 dB, the reply will be 16.0</p>	N/A	REB?	REB=xx.x (see Description of Arguments)
Tx Power Level Increase	N/A	3 bytes	<p>Query only.</p> <p>Returns the increase in Tx power level, in dB (from the nominal setting) due to the action of AUPC.</p> <p>Responds x.x if AUPC is disabled.</p> <p>EXAMPLE: <0/PLI? >0/PLI=2.3</p>	N/A	PLI?	PLI=x.x (see Description of Arguments)
Tx Clock Source	TCK=	1 byte, 0 thru 3	<p>Command or Query.</p> <p>Sets or returns Tx Clock Source in the form x, where:</p> <p>0=Internal 1=Tx Terrestrial 2=Rx Loop-Timed 3=Ext TT (ST=RxSat)</p> <p>EXAMPLE: <0/TCK=0 (selects Internal)</p>	TCK= TCK? TCK* TCK#	TCK?	TCK=x (see Description of Arguments)
Tx Clock Invert	TCI=	1 byte, 0 or 1	<p>Command or Query.</p> <p>Sets or returns Invert Transmit Data Clock in the form x, where:</p> <p>0=Normal 1=Inverted</p>	TCI= TCI? TCI* TCI#	TCI?	TCI=x (see Description of Arguments)
Tx Audio Volume Control	TVL=	4 bytes	<p>Command or Query. (Audio/IDR parameter)</p> <p>Sets or returns Tx Audio Volume control in the form aabb, where:</p> <p>aa=Tx 1 volume control in dB, valid values are -6, -4, -2, +0, +2, +4, +6, +8; bb=Tx 2 volume control in dB, valid values are -6, -4, -2, +0, +2, +4, +6, +8;</p> <p>EXAMPLE: <0/TVL=-2+4 (sets Tx 1 to 2 dB and Tx 2 to +4 dB)</p>	TVL= TVL? TVL* TVL#	TVL?	TVL=aabb (see Description of Arguments)
Transmit Terrestrial Alarm Mask	TTA=	1 byte, 0 or 1	<p>Command or Query. (DROP parameter)</p> <p>Sets or returns Tx Terrestrial Alarm Mask conditions in the form x, where:</p> <p>0=Alarm is active (unmasked). 1=Alarm is masked.</p> <p>EXAMPLE: <0/TTA=1 (masks an alarm).</p>	TTA= TTA? TTA* TTA#	TTA?	TTA=x (see Description of Arguments)

Parameter Type	Command (Instruction & Qualifier)	Number of Arguments	Description of Arguments	Response to Command	Query (Instruction & Qualifier)	Response to Query
Drop Type	DTY=	1 byte, 0 thru 3	Command or Query. (DROP/D&I++/QDI parameter) Sets or returns Drop Type in the form x, where: 0=T1-D4 1=T1-ESF 2=E1-CCS 3=E1-CAS	DTY= DTY? DTY* DTY#	DTY?	DTY=x (see Description of Arguments)
Tx Drop Timeslot	DTS=	3 bytes	Command or Query. (DROP parameter) (Note different format between command and query.) Sets or returns Tx Drop timeslot – Command format is in the form xxy, where: xx=Channel 01 through 24 y=timeslot: 0-9, A=10, B=11, C=12, D=13,...V=31	DTS= DTS? DTS* DTS#	DTS?	DTS=yyyyyyyyyyyyyyyy yyyyyyyy indicating all 24 Drop timeslots values associated with the 24 Tx Satellite channels.
Tx Ternary Code	TTC=	1 byte, 0 thru 3	Command or Query. (G.703 parameter) Sets or returns Tx Ternary Code in the form x, where: 0=AMI 1=B8ZS 2=B6ZS 3=HDB3 EXAMPLE: <0/ TTC=1 (selects B8ZS)	TTC= TTC? TTC* TTC#	TTC?	TTC=x (see Description of Arguments)
Transmit Backward Alarms Enable	TBA=	4 bytes, each 0 thru 2	Command or Query. (IDR parameter) Sets or returns Tx Backward Alarm Enable in the form xxxx, where: 0=Disable 1=Enable Internal (S/W) 2=Enable External (H/W) EXAMPLE: <0/TBA=0120	TBA= TBA? TBA* TBA#	TBA?	TBA=xxxx Position indicates backward alarm numbers: 1234
Transmit ESC Type	TET=	1 byte, 0 or 1	Command or Query. (IDR parameter) Sets or returns IDR ESC Type in the form x, where: 0=64k data channel 1=2 Audio channels	TET= TET? TET* TET#	TET?	TET=x (see Description of Arguments)
TX LO Frequency	TLO=	6 bytes	Command or Query. Sets or returns Tx LO frequency information in the form xxxxs, where: xxxxx=LO frequency, in MHz, from 3000 thru 65000, or 00000 (OFF) s=sign for the MIX (+ or –) NOTE: Terminal Frequency=LO ± TFQ EXAMPLE: <0/TLO=12000+ (BUC LO is 12GHz, low-side mix)	TLO= TLO? TLO* TLO#	TLO?	TLO=xxxxxs (see Description of Arguments)
Tx Satellite (Terminal) Frequency	N/A	10 bytes	Query only. Returns terminal (aka satellite) Tx Frequency, which is the frequency transmitted to the satellite, the form xxxxx.xxxx. Resolution=100 Hz NOTE: Returns 00000.0000 if LO is zero EXAMPLE: <0/TTF? >0/TTF=11650.2249	N/A	TTF?	TTF=xxxxx.xxxx (see Description of Arguments)
Tx Information Rate	N/A	9 bytes, numeric	Query only. Allows remote access to the Aggregate Tx Information Rate in the form ddddd.dd	TIR? TIR= TIR* TIR#	TIR?	TIR=dddd.d (see Description of Arguments)

Parameter Type	Command (Instruction & Qualifier)	Number of Arguments	Description of Arguments	Response to Command	Query (Instruction & Qualifier)	Response to Query
Tx Sub-Mux IP Information Rate	N/A	9 bytes, numeric	Query only. Allows remote access to the IP portion of the Tx Information Rate in the form ddddd.ddd	TMI? TMI= TMI* TMI#	TMI?	TMI=dddd.ddd (see Description of Arguments)

8.5.3 Rx Parameters

Priority System: RIT (Highest priority) , RFM, RFT, RMD, RCR, RDR, and RSR (Lowest Priority), indicated by **shading**. Any change to a higher priority parameter can override any of the parameters of lower priority.

Exception – Select DROP, D&I++ or QDI mode using RFM (Transmit Framing type), which is highest priority.

Parameter	Command (Instruction & Qualifier)	Length of Argument	Description of Arguments	Response to Command	Query (Instruction & Qualifier)	Response to Query
Rx Interface Type	RIT=	1 byte, 0 thru 9, or A	Command or Query. Sets or returns Rx Interface Type in the form x, where: 0=RS422 1=V.35 2= reserved – do not use. 3=Balanced G.703 4=Unbalanced G.703 5=Audio (only at 64 kbps) (IBS/EDMAC only) (FAST option) 6=LVDS 7=HSSI 8=IP 9=ASI A=IP-ACM B=VersaFEC-2 ACM (requires VFEC-2 option card and VFEC-2 ACM FAST option) EXAMPLE: <0/RIT=1 (selects V.35)	RIT= RIT? RIT* RIT#	RIT?	RIT=x (see Description of Arguments)
Rx Framing Mode	RFM=	1 byte, 0 thru 9, A	Command or Query. Sets or returns Rx Framing Mode in the form x, where: 0=Unframed 1=IBS (requires Open Network FAST option) 2=IDR (requires Open Network FAST option) 3=D&I (requires D&I FAST option) 4=EDMAC 5=D&I++ (requires D&I FAST option) 6=ESC++ 7=EDMAC-2 8=Quad Drop & Insert (requires QDI FAST option) 9=Framed QDI (requires QDI FAST option) (G.703 Balanced, E1-CCS only) A=EDMAC-3 EXAMPLE: <0/RFM=0 (selects Unframed mode)	RFM= RFM? RFM* RFM#	RFM?	RFM=x (see Description of Arguments)

Parameter	Command (Instruction & Qualifier)	Length of Argument	Description of Arguments	Response to Command	Query (Instruction & Qualifier)	Response to Query
Rx FEC Type	RFT=	1 byte, 0 thru 9, A thru D	Command or Query. Sets or returns Rx FEC Type in the form x, where: 0=None (uncoded) with differential encoding ON 1=Viterbi 2=Viterbi + Reed-Solomon 3=Sequential 4=Sequential + Reed-Solomon 5=TCM (Trellis Code Modulation) 6=TCM + Reed-Solomon 7=TPC (aka Turbo) (Requires Codec, FAST) 8=None (uncoded) with differential encoding OFF 9=LDPC (Requires Codec, FAST) A=VersaFEC CCM or ACM (Fixed in IP-ACM) B=VersaFEC ULL C=VersaFEC-2 Long Block D=VersaFEC-2 Short Block EXAMPLE: <0/RFT=1 (selects Viterbi only)	RFT= RFT? RFT* RFT#	RFT?	RFT=x (see Description of Arguments)
Rx Demod Type	RMD=	1 byte, 0 thru 8	Command or Query (Query only in ACM). Sets or returns Rx Demodulation in the form x, where: 0=BPSK 1=QPSK 2=QPSK 3=8-PSK (FAST option) 4=16-QAM (Turbo or Viterbi + RS only)(FAST option) 5=8-QAM (TPC/LDPC only) (Needs Codec + FAST option) 6=8-ARY (VersaFEC-2 only) 7=16-ARY (VersaFEC-2 only) 8=32-ARY (VersaFEC-2 only) Depending on FEC type, not all of these selections will be valid. All other codes are invalid. EXAMPLE: <0/RMD=2 (selects QPSK)	RMD= RMD? RMD* RMD#	RMD?	RMD=x (see Description of Arguments)
Rx FEC Code Rate	RCR=	1 byte, 0 thru 7, A thru Z, a thru z, ", &, @, [,], {, }	Command or Query (Query only in ACM). Sets or returns Rx FEC Code Rate in the form x, where: 0=Rate 1/2 1=Rate 3/4 2=Rate 7/8 3=Rate 2/3 (8-PSK TCM or LDPC only) 4=Rate 1/1 (Uncoded or No FEC) 5=Rate 21/44 (Turbo Only) 6=Rate 5/16 (Turbo Only) 7=Rate 0.95 (Turbo Only) (aka 17/18) 8=Reserved 9=Reserved A=VersaFEC CCM ModCod 0 – BPSK 0.488 B=VersaFEC CCM ModCod 1 – QPSK 0.533 C=VersaFEC CCM ModCod 2 – QPSK 0.631 D=VersaFEC CCM ModCod 3 – QPSK 0.706	RCR= RCR? RCR* RCR#	RCR?	RCR=x (see Description of Arguments)

Parameter	Command (Instruction & Qualifier)	Length of Argument	Description of Arguments	Response to Command	Query (Instruction & Qualifier)	Response to Query
...Rx FEC Code Rate (cont.)			E=VersaFEC CCM ModCod 4 – QPSK 0.803 F=VersaFEC CCM ModCod 5 – 8-QAM 0.642 G=VersaFEC CCM ModCod 6 – 8-QAM 0.711 H=VersaFEC CCM ModCod 7 – 8-QAM 0.780 I=VersaFEC CCM ModCod 8 – 16-QAM 0.731 J=VersaFEC CCM ModCod 9 – 16-QAM 0.780 K=VersaFEC CCM ModCod 10 – 16-QAM 0.829 L=VersaFEC CCM ModCod 11 – 16-QAM 0.853 M=Reserved N=Reserved O=VersaFEC CCM ModCod 14 – 8-QAM 0.576 P=VersaFEC CCM ModCod 15 – 16-QAM 0.644 Q=Reserved R=VersaFEC CCM ULL ModCod 17 – BPSK 0.493 S=VersaFEC CCM ULL ModCod 18 – QPSK 0.493 T=VersaFEC CCM ULL ModCod 19 – QPSK 0.654 U=VersaFEC CCM ULL ModCod 20 – QPSK 0.734 V=VersaFEC-2 ModCod 0 – BPSK 0.489 W=VersaFEC-2 ModCod 1 – QPSK 0.489 X=VersaFEC-2 ModCod 2 – QPSK 0.537 Y=VersaFEC-2 ModCod 3 – QPSK 0.586 Z=VersaFEC-2 ModCod 4 – QPSK 0.611 a=VersaFEC-2 ModCod 5 – QPSK 0.635 b=VersaFEC-2 ModCod 6 – QPSK 0.660 c=VersaFEC-2 ModCod 7 – QPSK 0.684 d=VersaFEC-2 ModCod 8 – QPSK 0.733 e=VersaFEC-2 ModCod 9 – 8-ARY 0.521 f=VersaFEC-2 ModCod 10 – 8-ARY 0.537 g=VersaFEC-2 ModCod 11 – 8-ARY 0.562 h=VersaFEC-2 ModCod 12 – 8-ARY 0.586 i=VersaFEC-2 ModCod 13 – 8-ARY 0.611 j=VersaFEC-2 ModCod 14 – 8-ARY 0.635 k=VersaFEC-2 ModCod 15 – 8-ARY 0.660 l=VersaFEC-2 ModCod 16 – 8-ARY 0.684 m=VersaFEC-2 ModCod 17 – 8-ARY 0.708 n=VersaFEC-2 ModCod 18 – 8-ARY 0.733 o=VersaFEC-2 ModCod 19 – 16-ARY 0.586 p=VersaFEC-2 ModCod 20 – 16-ARY 0.611 q=VersaFEC-2 ModCod 21 – 16-ARY 0.635 r=VersaFEC-2 ModCod 22 – 16-ARY 0.660 s=VersaFEC-2 ModCod 23 – 16-ARY 0.684 t=VersaFEC-2 ModCod 24 – 16-ARY 0.708 u=VersaFEC-2 ModCod 25 – 16-ARY 0.733 v=VersaFEC-2 ModCod 26 – 16-ARY 0.757 w=VersaFEC-2 ModCod 27 – 16-ARY 0.782 x=VersaFEC-2 ModCod 28 – 32-ARY 0.660 y=VersaFEC-2 ModCod 29 – 32-ARY 0.684			

Parameter	Command (Instruction & Qualifier)	Length of Argument	Description of Arguments	Response to Command	Query (Instruction & Qualifier)	Response to Query
...Rx FEC Code Rate (cont)			z=VersaFEC-2 ModCod 30 – 32-ARY 0.708 *=VersaFEC-2 ModCod 31 – 32-ARY 0.733 &=VersaFEC-2 ModCod 32 – 32-ARY 0.757 @=VersaFEC-2 ModCod 33 – 32-ARY 0.782 [=VersaFEC-2 ModCod 34 – 32-ARY 0.801]=VersaFEC-2 ModCod 35 – 32-ARY 0.831 {=VersaFEC-2 ModCod 36 – 32-ARY 0.855 (Long Block only) }=VersaFEC-2 ModCod 37 – 32-ARY 0.879 (Long Block only) Depending on FEC type, not all of these selections will be valid. EXAMPLE: <0/RCR=1 (selects Rate 3/4)			
Rx Data Rate	RDR=	9 bytes	Command or Query (Query only in ACM). Sets or returns Rx Data Rate, the formxxxx.xxx, where: xxxxx.xxx=Value, in kbps, from 18 kbps to 25 Mbps Resolution=1 bps EXAMPLE: <0/RDR=02047.999. NOTES: 1) Additional auxiliary G.703 sub-rates are available, selected using: 00512.AUX 01024.AUX 02048.AUX 2) If set for QDI (Quad D&I), RDR is query only. 3) The connectors used for the Aux rates are IDI/DDO. 4) These Aux rates are not available with D&I or IDR.	RDR= RDR? RDR* RDR#	RDR?	RDR=xxxxx.xxx (see Description of Arguments)
Rx Symbol Rate	RSR=	9 bytes, numeric	Query only (Command or Query in IP-ACM or VersaFEC-2 ACM). Allows remote access to the Rx Symbol Rate in the form ddddd.ddd NOTE: Symbol Rate ranges in IP-ACM=37 ksym/sec to 4100 ksym/sec Symbol Rate ranges in VersaFEC-2 ACM Short Block=37 ksym/sec to 1000 ksym/sec Symbol Rate ranges in VersaFEC-2 ACM Long Block=37 ksym/sec to 125000 ksym/sec	RSR= RSR? RSR* RSR#	RSR?	RSR=dddd.ddd (see Description of Arguments)
Rx Frequency	RFQ=	9 bytes Exception – 600 Emulation: 8 bytes	Command or Query. Sets or returns Frequency ranges in the form xxxx.xxxx where: 70/140 MHz Unit range is from 50 MHz to 180 MHz, and L-Band (FAST option) Unit range is from 950 MHz to 2250 MHz Resolution=100Hz. EXAMPLE: <0/RFQ=0950.9872	RFQ= RFQ? RFQ* RFQ#	RFQ?	RFQ=xxxx.xxxx (see Description of Arguments) Exception – 600 Emulation: RFQ=xxx.xxxx
Rx Data Invert	RDI= Exception – 600/L Emulation: IRD=	1 byte, 0 or 1	Command or Query. Invert Receive Data in the form x, where: 0=Normal 1=Inverted EXAMPLE: <0/RDI=1 (selects Inverted RX Data)	RDI= RDI? RDI* RDI#	RDI? Exception – 600/L Emulation: IRD?	RDI=x (see Description of Arguments)
Rx Sub-Mux on/off	RMX=	1 byte, 0 or 1	Command or Query. Sets or returns Rx Sub-Mux in the form x, where: 0=Off 1=On	RMX? RMX= RMX* RMX#	RMX?	RMX=x (see Description of Arguments)

Parameter	Command (Instruction & Qualifier)	Length of Argument	Description of Arguments	Response to Command	Query (Instruction & Qualifier)	Response to Query																																				
Rx Sub-Mux Ratio	RMR=	2 bytes, numeric	<p>Command or Query.</p> <p>Sets or returns Rx Sub-Mux Ratio (IP/Synchronous Interface) in the form xx, where:</p> <table style="width: 100%; border: none;"> <tr> <td style="width: 25%;">00=1/9</td> <td style="width: 25%;">09=3/7</td> <td style="width: 25%;">18=3/2</td> <td style="width: 25%;">27=6/1</td> </tr> <tr> <td>01=1/8</td> <td>10=1/2</td> <td>19=5/3</td> <td>28=7/1</td> </tr> <tr> <td>02=1/7</td> <td>11=3/5</td> <td>20=2/1</td> <td>29=8/1</td> </tr> <tr> <td>03=1/6</td> <td>12=2/3</td> <td>21=7/3</td> <td>30=9/1</td> </tr> <tr> <td>04=1/5</td> <td>13=3/4</td> <td>22=5/2</td> <td>31=1/59</td> </tr> <tr> <td>05=1/4</td> <td>14=4/5</td> <td>23=3/1</td> <td>32=1/39</td> </tr> <tr> <td>06=2/7</td> <td>15=1/1</td> <td>24=7/2</td> <td>33=1/19</td> </tr> <tr> <td>07=1/3</td> <td>16=5/4</td> <td>25=4/1</td> <td></td> </tr> <tr> <td>08=2/5</td> <td>17=4/3</td> <td>26=5/1</td> <td></td> </tr> </table> <p>EXAMPLE: <0/RMR=01 (Selects ratio 1/8)</p>	00=1/9	09=3/7	18=3/2	27=6/1	01=1/8	10=1/2	19=5/3	28=7/1	02=1/7	11=3/5	20=2/1	29=8/1	03=1/6	12=2/3	21=7/3	30=9/1	04=1/5	13=3/4	22=5/2	31=1/59	05=1/4	14=4/5	23=3/1	32=1/39	06=2/7	15=1/1	24=7/2	33=1/19	07=1/3	16=5/4	25=4/1		08=2/5	17=4/3	26=5/1		RMR? RMR= RMR* RMR#	RMR?	RMR=xx (see Description of Arguments)
00=1/9	09=3/7	18=3/2	27=6/1																																							
01=1/8	10=1/2	19=5/3	28=7/1																																							
02=1/7	11=3/5	20=2/1	29=8/1																																							
03=1/6	12=2/3	21=7/3	30=9/1																																							
04=1/5	13=3/4	22=5/2	31=1/59																																							
05=1/4	14=4/5	23=3/1	32=1/39																																							
06=2/7	15=1/1	24=7/2	33=1/19																																							
07=1/3	16=5/4	25=4/1																																								
08=2/5	17=4/3	26=5/1																																								
Rx Reed-Solomon Decoding	RRS=	1 byte, 0 thru 3	<p>Command or Query.</p> <p>Sets or returns Rx RS decoding in the form x, where:</p> <p>0=Normal (based on the Open Network framing selected)</p> <p>1=IESS-310 mode, valid with QDI, unframed, IBS, D&I, IDR.</p> <p>2=EF Data legacy standard (225,205) – unframed, QDI only</p> <p>3=IBS (126,112) – unframed only</p> <p>NOTE: Available in all framing modes except EDMAC (this is a 'don't care' if no R-S is selected in FEC type)</p> <p>EXAMPLE: <0/RRS=0 (selects Normal)</p>	RRS= RRS? RRS* RRS#	RRS?	RRS=x (see Description of Arguments)																																				
Rx Spectrum Invert	RSI=	1 byte, 0 or 1	<p>Command or Query.</p> <p>Sets or returns Rx Spectrum Invert in the form x, where:</p> <p>0=Normal</p> <p>1=Rx Spectrum Invert</p> <p>EXAMPLE: <0/RSI=0 (selects Normal)</p>	RSI= RSI? RSI* RSI#	RSI?	RSI=x (see Description of Arguments)																																				
Rx Descrambler	RDS=	1 byte, 0 or 1	<p>Command or Query.</p> <p>Sets or returns Rx Descrambler state in the form x, where:</p> <p>0=Off</p> <p>1=Normal</p> <p>2=IESS-315</p> <p>EXAMPLE: <0/RDS=1 (Scrambler On)</p>	RDS= RDS? RDS* RDS#	RDS?	RDS=x (see Description of Arguments)																																				
Rx Demod Acquisition Sweep Width	RSW=	3 bytes Exception – 600L Emulation: 2 bytes	<p>Command or Query.</p> <p>Sets or returns Rx ± Acquisition Sweep Range of demodulator, in kHz.</p> <p>Available range depends on the symbol rate:</p> <table style="width: 100%; border: none;"> <tr> <td style="width: 60%;">18 kspss to 64 kspss:</td> <td>± 1 to the symbol rate (kspss)/2</td> </tr> <tr> <td>64 kspss to 389 kspss:</td> <td>± 1 to the symbol rate (kspss)/2</td> </tr> <tr> <td>389 kspss to 3000 kspss:</td> <td>± 1 to the symbol rate (kspss)/2</td> </tr> <tr> <td>>3000 kspss:</td> <td>± 1 to the symbol rate (kspss)/2</td> </tr> </table> <p>EXAMPLE: <0/RSW=009 (selects ± 9 kHz)</p>	18 kspss to 64 kspss:	± 1 to the symbol rate (kspss)/2	64 kspss to 389 kspss:	± 1 to the symbol rate (kspss)/2	389 kspss to 3000 kspss:	± 1 to the symbol rate (kspss)/2	>3000 kspss:	± 1 to the symbol rate (kspss)/2	RSW= RSW? RSW* RSW#	RSW?	RSW=xxx (see Description of Arguments)																												
18 kspss to 64 kspss:	± 1 to the symbol rate (kspss)/2																																									
64 kspss to 389 kspss:	± 1 to the symbol rate (kspss)/2																																									
389 kspss to 3000 kspss:	± 1 to the symbol rate (kspss)/2																																									
>3000 kspss:	± 1 to the symbol rate (kspss)/2																																									

Parameter	Command (Instruction & Qualifier)	Length of Argument	Description of Arguments	Response to Command	Query (Instruction & Qualifier)	Response to Query
Rx Clock Source	RCK=	1 byte, 0 thru 3	Command or Query. Sets or returns Rx Clock Source in the form x, where: 0=Rx Satellite 1=Tx-Terrestrial 2=Internal(SCT) 3=INSERT (command valid only when Rx framing is Insert or D&I++ and interface is G.703 or set for D&I loop) EXAMPLE: <0/RCK=1 (selects Tx-Terrestrial)	RCK= RCK? RCK* RCK#	RCK?	RCK=x (see Description of Arguments)
Rx Clock Invert	RCI=	1 byte, 0 or 1	Command or Query. Sets or returns Invert Receive Clock, in the form x, where: 0=Normal 1=Inverted	RCI= RCI? RCI* RCI#	RCI?	RCI=x (see Description of Arguments)
Eb/No Alarm Point	EBA=	4 bytes	Command or Query. Sets or returns Eb/No alarm point in the form xx.x, where: xx.x=Value, in dB, from 0.1 to 16 Resolution=0.1 dB EXAMPLE: <0/EBA=12.3	EBA= EBA? EBA* EBA#	EBA?	EBA=xx.x (see Description of Arguments)
Rx Buffer Size	RBS=	5 bytes	Command or Query. Sets or returns Rx Buffer Size in the form xxxxx, where: xxxxx=Value, in 2-byte steps (unless other limitations apply), from 00016 to 32768 bytes (See Chapter 6, Sect. 6.2.1.5.2) EXAMPLE: <0/RBS=08192 (selects 8192 bytes)	RBS= RBS? RBS* RBS#	RBS?	RBS=xxxxx (see Description of Arguments)
Rx Audio Volume Control	RVL=	4 bytes	Command or Query. (Audio/IDR parameters) Sets or returns Rx Audio Volume control in the form aabb, where: aa=Rx 1 volume control value, in dB: Valid values are -6, -4, -2, +0, +2, +4, +6, +8; bb=Rx 2 volume control value, in dB: Valid values are -6, -4, -2, +0, +2, +4, +6, +8. EXAMPLE: <0/RVL=-2+4 (sets Rx 1 to -2 dB and Rx 2 to +4 dB)	RVL= RVL? RVL* RVL#	RVL?	RVL=aabb (see Description of Arguments)
Receive Terrestrial Alarm Enable	RTE=	1 byte, 0 or 1	Command or Query. (INSERT mode parameter) Sets or returns Receive Terrestrial Alarm Enable conditions in the form x, where: 0=Disables the alarm 1=Enables the alarm. EXAMPLE: <0/RTE=0 (disables the alarm).	RTE= RTE? RTE* RTE#	RTE?	RTE=x (see Description of Arguments)
Insert Type	ITY=	1 byte, 0 thru 3	Command or Query. (INSERT/D&I++/QDI parameter) Sets or returns Insert Type, in the form x, where: 0=T1-D4 1=T1-ESF 2=E1-CCS 3=E1-CAS	ITY= ITY? ITY* ITY#	ITY?	ITY=x (see Description of Arguments)
Rx Ternary Code	RTC=	1 byte, 0 thru 3	Command or Query. (G.703 parameter) Sets or returns Rx Ternary Code in the form x, where: 0=AMI 1=B8ZS 2=B6ZS 3=HDB3 EXAMPLE: <0/ RTC=1 (selects B8ZS)	RTC= RTC? RTC* RTC#	RTC?	RTC=x (see Description of Arguments)

Parameter	Command (Instruction & Qualifier)	Length of Argument	Description of Arguments	Response to Command	Query (Instruction & Qualifier)	Response to Query
Receive Backward Alarms Enable	RBA=	4 bytes, each 0 or 1	Command or Query. (IDR parameter) Sets or returns Receive Backward Alarms enable in the form xxxx, where: 0=Disable 1=External trigger Enable EXAMPLE: <0/RBA=0101	RBA= RBA? RBA* RBA#	RBA?	RBA=xxxx (see Description of Arguments)
Receive ESC Type	RET=	1 byte, 0 or 1	Command or Query. (IDR parameter) Sets or queries IDR ESC Type in the form x, where: 0=64k data channel 1=2 Audio channels	RET= RET? RET* RET#	RET?	RET=x (see Description of Arguments)
Insert Timeslot	ITS=	3 bytes	Command or Query. (D&I/D&I++ only) (Note different format between command and query.) Command sets Insert Timeslot in the form xxy, where: xx=Channel 01 through 24 y=timeslot: 0-9, A=10, B=11, C=12, D=13,...V=31	ITS= ITS? ITS* ITS#	ITS?	ITS=yyyyyyyyyyyyyyyy yyyyyyyyy indicating all 24 Insert timeslots values associated with the 24 Rx Satellite channels.
ReCenter Buffer	RCB=	None	Command only. This command takes no arguments. Forces the modem to recenter the receive Plesiochronous/Doppler buffer. EXAMPLE: <0/RCB=	RCB= RCB? RCB* RCB#	N/A	N/A
RX LO Frequency	RLO=	6 bytes	Command or Query. Sets or returns LNB Rx LO frequency information in the form xxxxs, where: xxxx=LO frequency: 03000 through 65000 MHz, or 00000=Off s=sign for the MIX (+ or -)(See Note 1) NOTES: 1) Negative mix induces a spectral inversion. 2) For additional information see Chapter 6 for LO, MIX, and Spectrum Settings. 3) Rx Terminal Frequency=RX LO ± modem RFQ (see below)	RLO= RLO? RLO* RLO#	RLO?	RLO=xxxxs (see Description of Arguments)
Rx Terminal Frequency	N/A	10 bytes	Query only. Returns Rx Terminal Frequency (the frequency, in MHz, being received from the satellite) in the form xxxxx.xxxx. Resolution=100 Hz NOTES: 1) For additional information see Chapter 6 for LO, MIX, and Spectrum Settings. 2) Returns 00000.0000 if LNB LO is zero EXAMPLE: <0/RTF? >0/RTF=11650.2249 (MHz)	N/A	RTF?	RTF=xxxxx.xxxx (see Description of Arguments)
Receive Equalizer Enable and Rx Alpha	REE=	1 byte	Command or Query. Sets or returns Rx Equalizer and Rx Alpha in the form x, where: 0=Rx Equalizer Disabled and Rx Alpha=0.35 (DEFAULT) 1=Rx Equalizer Enabled and Rx Alpha=0.35 2=Rx Equalizer Disabled and Rx Alpha=0.12 3=Rx Equalizer Enabled and Rx Alpha=0.12	REE= REE? REE* REE#	REE?	REE=x (see Description of Arguments)
Rx Info Rate	N/A	9 bytes, numeric	Query only. Allows remote access to the Aggregate Rx Information Rate in the form ddddd.ddd	RIR? RIR= RIR* RIR#	RIR?	RIR=dddd.ddd (see Description of Arguments)

Parameter	Command (Instruction & Qualifier)	Length of Argument	Description of Arguments	Response to Command	Query (Instruction & Qualifier)	Response to Query
Rx Sub-Mux IP Info Rate	N/A	9 bytes, numeric	Query only. Allows remote access to the IP portion of the Rx Information rate in the form ddddd.dd	RMI? RMI= RMI* RMI#	RMI?	RMI=dddd.d (see Description of Arguments)

8.5.4 Unit Parameters

Parameter	Command (Instruction & Qualifier)	Length of Arguments	Description of Arguments	Response to Command	Query (Instruction & Qualifier)	Response to Query
Local/Remote Status	LRS=	1 byte, 0 thru 3	Command or Query. Sets or returns the user's Local/Remote status in the form x, where: 0=Local 1=Serial Remote (RS-232/RS-485) 2=Reserved 3=Ethernet Remote EXAMPLE: <0/LRS=1 (selects Serial Remote)	LRS LRS? LRS* LRS#	LRS?	LRS=x (see Description of Arguments)
Modem Emulation	EMU=	1 byte, 0 thru 2	Command or Query. The CDM-625A is designed to be a 'drop-in' replacement for the CDM-600 or CDM-600L modems. This parameter permits the CDM-625A modem emulate CDM-600/L operation. The format for the argument is x, where x is: 0=full capability CDM-625A modem (DEFAULT) 1=CDM-600 modem emulation 2=CDM-600L modem emulation Note: For complete modem emulation, all parameters, including the EID (equipment ID) must be that of the modem it is emulating.	EMU= EMU? EMU* EMU#	EMU?	EMU=x (see Description of Arguments)
Front Panel Lockout	FPL=	1 byte, numeric	Command or Query. Sets or returns the state of front-panel lockout in the form x, where: 0=no lockout 1=front panel lockout active. NOTE: Disable the lockout by either FPL=0, or by setting into local mode using LRS=0.	FPL= FPL? FPL* FPL#	FPL?	FPL=x (see Description of Arguments)
Software Image	IMG=	1 byte, 1 or 2	Command or Query. Sets or returns the active firmware image in the form x, where: 1=Bulk Image #1 currently active 2=Bulk Image #2 currently active	IMG= IMG? IMG* IMG#	IMG?	IMG=x (see Description of Arguments)
Circuit ID String	CID=	40 bytes	Command or Query. Sets or returns the user-defined Circuit ID string, which is a fixed length of 40 characters. Valid characters include: Space () * + - , . / 0-9 and A-Z	CID= CID? CID* CID#	CID?	CID=x (see Description of Arguments)
RTC Date	DAY=	6 bytes	Command or Query. Sets or returns a date in the form ddmmyy (European format), where dd=day of the month (01 to 31) mm=month (01 to 12) yy=year (00 thru 99) EXAMPLE: <0/DAY=240457 (April 24, 2057)	DAY= DAY? DAY* DAY#	DAY?	DAY=ddmmyy (see Description of Arguments)
RTC Time	TIM=	6 bytes	Command or Query. Sets or returns a time from midnight, in the form hhmmss, where: hh=hours (00 thru 23) mm=minutes (00 thru 59) ss=seconds (00 thru 59) EXAMPLE: <0/TIM=231259 (23 hours:12 minutes:59 seconds – 11:12:59 P.M.)	TIM= TIM? TIM* TIM#	TIM?	TIM=hhmmss (see Description of Arguments)

Parameter	Command (Instruction & Qualifier)	Length of Arguments	Description of Arguments	Response to Command	Query (Instruction & Qualifier)	Response to Query
Engineering Service Channel	ESC=	1 byte, 0 or 1	Command or Query. (IBS and ESC++ feature) Sets or returns ESC in the form x, where: 0=Disable the high-rate ESC 1=Enable the high-rate ESC NOTE: IBS ESC may only be enabled when: 1) Both Tx and Rx framing modes are set to IBS. 2) Data rate is not 1544 kbps (as spare overhead bits are not available in this mode). 3) IBS high-rate ESC FAST option is enabled.	ESC= ESC? ESC* ESC#	ESC?	ESC=x (see Description of Arguments)
ESC Parameters	SCP= Exception – 600/L Emulation: SCP=xy	3 bytes, numeric	Command or Query. (IBS and ESC++ feature) Sets or returns the ESC baud rate and character format in the form xyz, where: x=index for baud rate: 0=1200 baud 1=2400 baud 2=4800 baud 3=9600 baud 4=19200 baud 5=38400 baud 6=14400 baud 7=28800 baud y=character format (data bits, parity, stop bits): 0=8N1 char format 1=7E2 char format 2=7O2 char format z=interface type: 0=RS-232 1=RS-485 NOTE: The baud rate may be limited by the data rate. The ESC baud rate breakpoints (determined by data rate) are shown in Chapter 6 and Appendix J. A response of SCP* indicates that the data rate will not allow a selected baud rate to operate.	SCP= SCP? SCP* SCP#	SCP?	SCP=xyz (see Description of Arguments) Exception – 600/L Emulation: SCP=xy
EDMAC Framing Mode	EFM=	1 byte, 0 or 1	Command or Query. Sets or returns EDMAC mode in the form x, where: 0=EDMAC OFF (Idle Mode) 1=EDMAC ON (Master Mode) 2=EDMAC ON (Slave Mode, Query Only) EXAMPLE: <0/EFM=1 (EDMAC Enabled as Master)	EFM= EFM? EFM* EFM#	EFM?	EFM=x (see Description of Arguments)
EDMAC Slave Address Range	ESA=	4 bytes	Command or Query. Sets or returns EDMAC range of addresses of distant-end units (modems or transceivers) for which this unit, as the Master, will forward messages. Only values which are integer multiples of ten are permitted. (0010, 0020, 0030, 0040 etc.) EXAMPLE: <0/ESA=0090 NOTE: This command is only valid for an EDMAC master. When used as a Query, it may be sent to an EDMAC slave, which will respond with the appropriate address.	ESA= ESA? ESA* ESA#	ESA?	ESA=xxxx (see Description of Arguments)

Parameter	Command (Instruction & Qualifier)	Length of Arguments	Description of Arguments	Response to Command	Query (Instruction & Qualifier)	Response to Query
One Time EDMAC Slave Overwrite	OTO=	1 byte, 0 or 1	Command or Query. Sets or returns One Time Overwrite to EDMAC Slave modem in the form x, where: 0=Off 1=On EXAMPLE 1: OTO=0 disables One Time Overwrite – EDMAC Slave modem may only remotely accept EDMAC command from EDMAC Master modem. EXAMPLE 2: OTO=1 enables One Time Overwrite – EDMAC Slave modem may locally accept ONE remote control command.	OTO= OTO? OTO* OTO#	OTO?	OTO=x (see Description of Arguments)
External Frequency Reference	EFR= Exception – 600L Emulation: MRC=	1 byte, 0 thru 6	Command or Query. Sets or returns the External Frequency Reference in the form x, where: 0=Internal 10MHz (DEFAULT) 1=External 1 MHz 2=External 2 MHz 3=External 5 MHz 4=External 10 MHz 5=spare 6=Internal 10MHz plus output (this means that the Reference is available on the "Ext Ref" rear connector (small rear-panel LED indicates when ON))	EFR= EFR? EFR* EFR# Exception – 600L Emulation: MRC= MRC? MRC* MRC#	EFR? Exception – 600L Emulation: MRC=?	EFR=x (see Description of Arguments) Exception – 600L Emulation: MRC=x
Adjustment for Internal 10MHz High- stability Reference	ADJ=	4 bytes, numeric	Command or Query. Sets or returns fine adjustment of the Internal 10MHz Reference on the High-Stability Frequency Reference module in the form sddd, where: s=sign (+ or -) ddd=Value, 0-999.	ADJ= ADJ? ADJ* ADJ#	ADJ?	ADJ=sddd (see Description of Arguments)
Warm-up Delay	WRM=	1 byte, 0 or 1	Command or Query. (Hi-Stability Frequency Reference parameter) Sets or returns the High-Stability Frequency Reference warm-up delay parameter in the form x, where: 0=Delay off (instant on) 1=Warm-up Delay on	WRM= WRM? WRM* WRM#	WRM?	WRM=x (see Description of Arguments)
Countdown of Warm-up Delay remaining	CTD=	3 bytes, numeric	Command or Query. (Hi-Stability Frequency Reference parameter) Sets or returns the High-Stability Frequency Reference countdown parameter in the form xxx, where: xxx=countdown of the number of seconds remaining of the Warm-up time. NOTE: As a command, the only permitted format is CTD=000, which abandons the delay.	CTD= CTD? CTD* CTD#	CTD?	CTD=xxx (see Description of Arguments)
Unit Test Mode	TST=	1 byte, 0 thru 6	Command or Query. Unit Test Mode, where: 0=Normal Mode (no test) 1=Tx CW 2=Tx Alternating 1,0 Pattern 3=IF Loopback 4=RF Loopback 5=Digital Loopback 6=I/O Loopback EXAMPLE: <0/TST=3 (IF Loopback)	TST= TST? TST* TST#	TST?	TST=x (see Description of Arguments)

Parameter	Command (Instruction & Qualifier)	Length of Arguments	Description of Arguments	Response to Command	Query (Instruction & Qualifier)	Response to Query
Unit Alarm Mask	MSK=	13 bytes Exception – 600L Emulation: 6 bytes	Command or Query. Sets or returns Alarm Mask conditions in form abcdefghjklxx, where: a=Tx AIS b=Rx AIS c=buffer slip Alarm d=spare e=Rx AGC Alarm f=Eb/No Alarm g=BUC Alarm h=LNB Alarm j=G.703 Loss of Signal alarm k=Reference alarm l=Tx Clock Alarm m=CnC Lock Alarm x (spare) Value of each mask: 0=unmasked 1=masked EXAMPLE: <0/MSK=010110000000	MSK= MSK? MSK* MSK#	MSK?	MSK=abcdefghijklxx (see Description of Arguments)
Attach summary BUC fault to Tx FLT status	ABA=	1 byte, 0 or 1	Command or Query. Sets or returns BUC fault reporting in the form x, where: 0=Tx FLT status unaffected by BUC fault 1=Attach a summary BUC fault to Tx FLT status	ABA= ABA? ABA* ABA#	ABA?	ABA=x (see Description of Arguments)
Attach summary LNB fault to Rx FLT status	ALA=	1 byte, 0 or 1	Command or Query. Sets or returns LNB fault reporting in the form x, where: 0=Rx FLT status unaffected by LNB fault 1=Attach a summary LNB fault to Rx FLT status	ALA= ALA? ALA* ALA#	ALA?	ALA=x (see Description of Arguments)
Number of Unread stored Events	N/A	3 bytes	Query only. Returns the number of stored events that remain unread over remote control, in the form xxx, where xxx=000-255. EXAMPLE: <0/NUE? >0/NUE=126	N/A	NUE?	NUE=xxx (see Description of Arguments)
Retrieve next five unread Stored Events	N/A	80 bytes	Query only. Returns the oldest five stored events that have not yet been read over remote control in the form [CR]sub-body[CR]sub-body[CR]sub-body[CR]sub-body[CR]sub-body. Sub-body=ABCddmmyyhhmss, where: A=fault/clear indicator, where: F=Fault C=Clear I=Info B=fault type where: 1=Unit 2=Rx Traffic 3=Tx Traffic 4=Info (Power on/off, or log cleared) 5=Open Network 6=BUC 7=LNB	N/A	RNE?	RNE=[CR]ABCddmmyyhhmss[CR]ABCddmmyyhhmss[CR]ABCddmmyyhhmss[CR]ABCddmmyyhhmss[CR]ABCddmmyyhhmss (see Description of Arguments)

Parameter	Command (Instruction & Qualifier)	Length of Arguments	Description of Arguments	Response to Command	Query (Instruction & Qualifier)	Response to Query
...Retrieve next five unread Stored Events (cont.)			<p>C=Fault Code number, as in FLT? or Info Code, which may be: 0=Power Off 1=Power On 2=Log Cleared 3=Global Config Change 4=Redundancy Config Change 5=Fractional CnC License is expiring. 6=Time Limited CnC License is expiring. 7=Fractional CnC is in use. ddmmyy=date stamp. hhmmss=time stamp.</p> <p>NOTES: 1) If there are less than five retrievable events, the remaining positions are padded with zeros. 2) If there are no new events, the response is RNE*.</p>			
Clear All Stored Events	CAE=	None	<p>Command only. This command takes no arguments. Forces the modem to clear the firmware events log. EXAMPLE: <0/CAE=</p>	CAE= CAE? CAE* CAE#	N/A	N/A
Initialize Stored Events Pointer	IEP=	None	<p>Command only. Resets internal pointer to allow RNE? queries to start at the beginning of the stored events log.</p>	IEP= IEP#	N/A	N/A
Statistics Sample Interval	SSI=	1 byte, numerical	<p>Command or Query. Sets or returns the sample interval for the Statistics Logging Function in the form x, where: x=0 thru 9 in 10 minute steps. NOTE: Set this parameter to 0 thru disable the statistics logging function. EXAMPLE: <0/SSI=3 (interval is set at 30 minutes)</p>	SSI= SSI? SSI* SSI#	SSI?	SSI=x (see Description of Arguments)
Number of Unread stored Statistics	N/A	3 bytes	<p>Query only. Returns the number of stored statistics that remain unread over remote control, in the form xxx, where xxx=000-255. EXAMPLE: <0/NUS? >0/NUS=187</p>	N/A	NUS?	NUS=xxx (see Description of Arguments)
Retrieve next five unread Stored Statistics	N/A	135 bytes	<p>Query only. Returns the oldest five stored Statistics that have not yet been read, in the form [CR]sub-body[CR]sub-body[CR]sub-body[CR]sub-body[CR]sub-body where:</p> <ul style="list-style-type: none"> For all non-ACM modes, the statistics sub-body is defined as AA.ABB.BC.CD.Dddmmyyhhmmss where: AA.A=Minimum Eb/No during sample period. BB.B=Average Eb/No during sample period. C.C=Maximum Tx Power Level Increase during sample period. D.D=Average Tx Power Level Increase during sample period. ddmmyy=date stamp. hhmmss=time stamp. In VersaFEC ACM (IP-ACM) mode, the statistics sub-body is defined as AA.ABB.BC,DE,Fddmmyyhhmmss, where: AA.A=Minimum SNR during sample period. BB.B=Average SNR during sample period. C=IP-ACM Rx ModCod that was current at time the statistic entry was logged. D=Maximum Rx ModCod in hex during sample period. E=Minimum Rx ModCod in hex during sample period. 	N/A	RNS?	RNS=[CR]sub-body[CR]sub-body[CR]sub-body[CR]sub-body[CR]sub-body[CR]sub-body (see Description of Arguments)

Parameter	Command (Instruction & Qualifier)	Length of Arguments	Description of Arguments	Response to Command	Query (Instruction & Qualifier)	Response to Query
... Retrieve next five unread Stored Statistics (cont.)			<p>F=Number of Rx ModCod changes in hex format during sample period. ddmmyy=date stamp. hhmss=time stamp.</p> <ul style="list-style-type: none"> In VersaFEC-2 ACM mode, the statistics sub-body is defined as AA.ABB.BCC,DD,ddmmyyhhmss, where: AA.A=Minimum SNR during sample period. BB.B=Average SNR during sample period. CC=Maximum Rx ModCod in decimal during sample period. DD=Minimum Rx ModCod in decimal during sample period. ddmmyy=date stamp. hhmss=time stamp. <p>NOTES: 1) If there are less than five retrievable statistics, the remaining positions are padded with zeros. 2) If there are no new events, the unit replies with RNS*. 3) <i>Do not mix use of RNS and RNN.</i> Comtech EF Data recommends that you limit your use of RNS to maintain backward-compatibility with other legacy modems or when the unit is used in CDM600L Emulation mode. RNS is a legacy query that does NOT provide Rx Signal Level (RSL) information as RNN does. Since RNS and RNN use the same index system for statistics entries, if users mix use of the two queries, the statistics entries won't be displayed sequentially by either RNS or RNN. For this reason, and if you change your operating mode between Non-ACM and ACM (IP-ACM or V2-ACM) modes, Comtech EF Data recommends that you execute the Clear All Stored Statistics (CAS=) command before retrieving any further statistics.</p>			
Retrieve next 5 unread New Stored Statistics	N/A	180 bytes	<p>Query only. Unit returns the oldest five Stored Statistics (including newly added Minimum and Average Rx Signal Level (RSL)), which have not yet been read, in the form [CR]sub-body[CR]sub-body[CR] sub-body[CR]sub-body[CR]sub-body, where:</p> <ul style="list-style-type: none"> For all non-ACM modes, the statistics sub-body is defined as AA.ABB.BC.CD.DEE.E,FF.Fddmmyyhhmss where: AA.A=Minimum Eb/No during sample period. BB.B=Average Eb/No during sample period. C.C=Maximum Tx Power Level Increase during sample period. D.D=Average Tx Power Level Increase during sample period. EE.E=Negative value of Minimum Rx Signal Level (RSL) in dB during sample period. FF.F=Negative value of Average Rx Signal Level (RSL) in dB during sample period. ddmmyy = date stamp. hhmss = time stamp. In VersaFEC ACM (IP-ACM) mode the statistics sub-body is defined as AA.ABB.BC,DG,HEE.E,FF.Fddmmyyhhmss, where: AA.A=Minimum SNR during sample period. BB.B=Average SNR during sample period. C=Current IP-ACM Rx ModCod when the statistic entry was logged. D=Maximum Rx ModCod in hexadecimal during sample period. G=Minimum Rx ModCod in hexadecimal during sample period. H=Number of Rx ModCod changes in hex format during sample period. EE.E=Negative value of Minimum Rx Signal Level (RSL) in dB during sample period. FF.F=Negative value of Average Rx Signal Level (RSL) in dB during sample period. ddmmyy = date stamp. hhmss = time stamp. 	N/A	RNN?	RNN=[CR]sub-body[CR]sub-body[CR]sub-body[CR]sub-body[CR]sub-body[CR]sub-body (see Description of Arguments)

Parameter	Command (Instruction & Qualifier)	Length of Arguments	Description of Arguments	Response to Command	Query (Instruction & Qualifier)	Response to Query
... Retrieve next five unread Stored Statistics (cont.)			<ul style="list-style-type: none"> In VersaFEC-2 ACM mode, the statistics sub-body is defined as AA.ABB.BCC,DD,EE.E,FF.Fddmmyyhhmmss, where: AA.A=Minimum SNR during sample period. BB.B=Average SNR during sample period. CC=Maximum Rx ModCod in decimal during sample period. DD=Minimum Rx ModCod in decimal during sample period. EE.E=Negative value of Minimum Rx Signal Level (RSL) in dB during sample period. FF.F=Negative value of Average Rx Signal Level (RSL) in dB during sample period. ddmmyy = date stamp. hhmmss = time stamp. NOTES: 1) If there are less than five retrievable statistics, the remaining positions are padded with zeros. 2) If there are no new events, the unit replies with RNN*. 3) <i>Do not mix use of RNN and RNS.</i> Comtech EF Data recommends that you use the RNN query instead of the legacy RNS query. RNN includes all information provided in RNS *PLUS* Rx Signal Level (RSL). Since RNN and RNS use the same index system for statistics entries, if users mix use of the two queries, the statistics entries won't be displayed sequentially by either RNN or RNS. For this reason, or if you change your operating mode between Non-ACM and ACM (IP-ACM or V2-ACM) modes, Comtech EF Data recommends that you execute the Clear All Stored Statistics (CAS=) command before retrieving any further statistics.			
Clear All Stored Statistics	CAS=	None	Command only. This command takes no arguments. Forces the modem to clear the firmware statistics log. EXAMPLE: <0/CAS=.	CAS= CAS? CAS* CAS#	N/A	N/A
Initialize Statistics Pointer	ISP=	None	Command only. Resets internal pointer to allow RNS? queries to start at the beginning of the statistics log.	ISP= ISP#	N/A	N/A
Force 1:1 Switch	FSW=	None	Command only. This command takes no arguments Forces unit to toggle Unit Fail relay to "fail" state for approx 500ms. If unit is part of a 1:1 pair and is currently the 'Online' unit, this forces a switchover, so unit is then in 'Standby' mode. The command is always executed by the unit, regardless of whether it is standalone, in a 1:1 pair, or part of a 1:N system.	FSW= FSW*	N/A	N/A
Outdoor Unit Comms enable	ODU=	1 byte, 0 or 1	Command or Query. Enables or disables communications, via the FSK link, with a Comtech EF Data transceiver (ODU) in the form x, where: 0=Disabled 1=Enabled	ODU= ODU? ODU* ODU#	ODU?	ODU=x (see Description of Arguments)
1:N (One For N) control	OFN=	1 byte, 0 or 1	Command or Query. Enables or disables the 1:N control. This affects a control line on the 25-pin rear panel connector. This must be enabled when the modem is attached to a CRS-300 1:N Controller or a CRS-500 1:N Switch in the form x, where: 0=Disabled 1=Enabled	OFN= OFN? OFN* OFN#	OFN?	OFN=x (see Description of Arguments)

Parameter	Command (Instruction & Qualifier)	Length of Arguments	Description of Arguments	Response to Command	Query (Instruction & Qualifier)	Response to Query
IP Address	IPA=	18 bytes, numerical	Command or Query. Sets or returns the IP Address and network prefix for the 10/100 BaseT Ethernet management port, in the form aaa.bbb.ccc.ddd.yy, where: aaa=000-223 bbb=000-255 ccc=000-255 ddd=001-255 yy=08-30 EXAMPLE: <0/IPA=010.006.030.001.24	IPA= IPA? IPA* IPA#	IPA?	IPA= aaa.bbb.ccc.ddd.yy (see Description of Arguments)
IP Gateway	IPG=	15 bytes, numerical	Command or Query. Sets or returns the IP Gateway Address for the Ethernet Management port, in the form aaa.bbb.ccc.ddd, where: aaa=000-223 bbb=000-255 ccc=000-255 ddd=001-255 EXAMPLE: <0/IPG=010.006.030.001	IPG= IPG? IPG* IPG#	IPG?	IPG= aaa.bbb.ccc.ddd (see Description of Arguments)
Traffic IP Address	IPT=	18 bytes, numerical	Command or Query. In a 1:1 system, an external M&C application addresses each modem by its unique IP address. Whichever modem is online uses this address for the IP traffic in the form aaa.bbb.ccc.ddd.yy where: aaa=000-223 bbb=000-255 ccc=000-255 ddd=001-255 yy=Subnet Mask Length (08 to 30) EXAMPLE: <0/IPT=010.006.030.002.24	IPT= IPT? IPT* IPT#	IPT?	IPT= aaa.bbb.ccc.ddd.yy (see Description of Arguments)
MAC Address	N/A	12 bytes, alpha-numerical	Query only. Returns the unique MAC Address for the modem. EXAMPLE: <0/MAC? >0/MAC=0006B00001C2	N/A	MAC?	MAC=aabbccdeeff (see Description of Arguments)
Request to Send	RTS=	1 byte, 0 thru 2	Command or Query. Sets or returns how RTS/CTS operates at the main data interface in the form x, where: 0=RTS/CTS Loop, No Action (RTS and CTS are looped, so that CTS echoes the state of RTS, but RTS does not control the ON/OFF state of carrier.) 1=Loop, RTS Controls TX O/P (RTS and CTS are looped, so that CTS echoes the state of RTS and RTS controls the ON/OFF state of carrier (in order words, the modem will not bring up its TX carrier until RTS is asserted.) 2=Ignore RTS, Assert CTS. EXAMPLE: <0/RTS=0 (RTS/CTS Loop, No Action)	RTS= RTS? RTS* RTS#	RTS?	RTS=x (see Description of Arguments)
HSSI Handshake Control	HHC=	1 byte, 0 or 1	Command or Query. (HSSI parameter) Sets or returns TA/CA control of the HSSI interface in the form x, where: 0=TA to CA loop (DEFAULT) 1=RR control CA, TA control Tx output. EXAMPLE: <0/HHC=0 (TA to CA loop)	HHC= HHC? HHC* HHC#	HHC?	HHC=x (see Description of Arguments)

Parameter	Command (Instruction & Qualifier)	Length of Arguments	Description of Arguments	Response to Command	Query (Instruction & Qualifier)	Response to Query
POCO feature (Power-On Carrier-Off)	PCO=	1 byte, 0 or 1	Command or Query. When enabled, when a modem is power cycled, it powers up with the Tx carrier setting OFF. 0=POCO disabled (normal operation) 1=POCO enabled – Use with caution! EXAMPLE: <0/PCO=0 (disabled – normal operation)	PCO= PCO? PCO* PCO#	PCO?	PCO=x (see Description of Arguments)
DoubleTalk Carrier-in-Carrier (CnC) Mode	CNM=	1 byte, 0 thru 9	Command or Query. Sets or returns CnC operation in the form x, where: 0=Off 1=On (normal) 2=APC, C-Band, Side A 3=APC, X-Band, Side A 4=APC, Ku-Band, Side A 5=APC, Ka-Band, Side A 6=APC, C-Band, Side B 7=APC, X-Band, Side B 8=APC, Ku-Band, Side B 9=APC, Ka-Band, Side B NOTES: 1) CnC may be enabled only if: <ul style="list-style-type: none"> The optional plug-in hardware CnC card has been installed AND a CnC FAST option is unlocked. The range of permitted data rates is controlled by a FAST feature code. (Read EID to decode the installed options for the modem) 2) If CnC-APC is active (APS=22), key transmission/reception (Modulation, FEC type, Code Rate, Framing, Data Rate, Interface) cannot be modified until CnC-APC is suspended. (Use APC command to suspend or activate.)	CNM= CNM? CNM* CNM#	CNM?	CNM=x (see Description of Arguments)
DoubleTalk Carrier-in-Carrier (CnC) PMSI Mode	CPM=	1 byte, 0 thru 3	Command or Query. (CnC parameter) Sets or returns CnC PMSI (Pre-Mapped-Symbol Interface) mode in the form x, where: 0=Idle 1=Redundancy (1:1 or 1:N) 2=Talk 3=Listen	CPM= CPM? CPM* CPM#	CPM?	CPM=x (see Description of Arguments)
CnC Frequency Range/offset	CCF=	3 bytes	Command or Query. (CnC parameter) Sets or returns the maximum value that may be entered, in the form xxx, as the CnC Sweep frequency range depends on the Rx symbol rate as follows: 18ksps to 64ksps: ±1 to the symbol rate (ksps)/2 64ksps to 389ksps: ±1 to 32 kHz 389ksps to 2000ksps: ±1 to 10% of sym rate >2000ksp ±1 to 200 kHz EXAMPLE: <0/CCF=030	CCF= CCF? CCF* CCF#	CCF?	CCF=xxx (see Description of Arguments)
CnC Min/Max Search Delay	CSD=	6 bytes	Command or Query. (CnC parameter) Sets or returns CnC min/max delay value in milliseconds, in the form xxxyyy, where: xxx=minimum delay yyy=maximum delay Maximum allowable value is 330ms EXAMPLE: <0/CSD=010325	CSD= CSD? CSD* CSD#	CSD?	CSD=xxxxyy (see Description of Arguments)

Parameter	Command (Instruction & Qualifier)	Length of Arguments	Description of Arguments	Response to Command	Query (Instruction & Qualifier)	Response to Query
G.703 Clock Extension	CEX=	2 bytes	<p>Command or Query. (FAST option) Sets or returns G.703 Clock Extension in the form ab, where:</p> <p>a=G.703 Clock Extension Mode 0=None 1=TxLock 2=RxEnable</p> <p>b=G.703 Clock Extension Interface 0=T1 1=E1Bal 2=E1Unbal</p> <p>EXAMPLE: <0/CEX=12 (Sets Tx Lock to E1 Unbalanced)</p> <p>NOTES: 1) Not all CEX modes are valid all the time. 2) For argument a: If Data Interface (ITF) is G.703, only 0=None is allowed. If Tx clock (TCK) is not Internal, 1=TxLock is not allowed.</p>	CEX= CEX? CEX* CEX#	CEX?	CEX=ab (see Description of Arguments)
Tx BERT State	BTX=	1 byte, 0 or 1	<p>Command or Query. Sets or returns Tx BERT State in the form x, where: 0=Off 1=On</p> <p>EXAMPLE: <0/BTX=1 (Tx BERT On)</p>	BTX= BTX? BTX#	BTX?	BTX=x (see Description of Arguments)
Rx BERT State	BRX=	1 byte, 0 or 1	<p>Command or Query. Sets or returns Rx BERT State in the form x, where: 0=Off 1=On</p> <p>EXAMPLE: <0/BRX=1 (Rx BERT On)</p>	BRX= BRX? BRX#	BRX?	BRX=x (see Description of Arguments)
Tx BERT Pattern	TBP=	1 byte	<p>Command or Query. Sets or returns Tx BERT Pattern, in the form x, where:</p> <p>0=space 1=mark 2=1:1 3=1:2 4=63 5=511 6=2047 (DEFAULT) 7=2047R (or 2047 Alternate) 8=Mil-188 9=2¹⁵-1 A=2²⁰-1 B=2²³-1</p> <p>EXAMPLE: <0/TBP=6 (Tx BERT Pattern is 2047)</p>	TBP= TBP? TBP#	TBP?	TBP=x (see Description of Arguments)

Parameter	Command (Instruction & Qualifier)	Length of Arguments	Description of Arguments	Response to Command	Query (Instruction & Qualifier)	Response to Query
Rx BERT Pattern	RBP=	1 byte	Command or Query. Sets or returns Rx BERT Pattern, in the form x, where: 0=space 1=mark 2=1:1 3=1:2 4=63 5=511 6=2047 (DEFAULT) 7=2047R (or 2047 Alternate) 8=Mil-188 9=2 ¹⁵ -1 A=2 ²⁰ -1 B=2 ²³ -1 EXAMPLE: <0/RBP=6 (Rx BERT Pattern is 2047)	RBP= RBP? RBP#	RBP?	RBP=x (see Description of Arguments)
BERT 10E-3 Error Insert	BKE=	1 byte, 0 or 1	Command or Query. Inserts 10E-3 BER in the form x, where: 0=Off 1=On EXAMPLE: <0/BKE=1	BKE= BKE? BKE#	BKE?	BKE=x (see Description of Arguments)
BERT Restart Monitor	BRM=	None	Command only. This command takes no arguments. Forces restart of the BERT monitor. EXAMPLE: <0/BRM=	BRM=	N/A	N/A
BERT Result in bit errors	N/A	7 bytes, numeric	Query only. Returns BERT monitor results in bit errors. NOTE: If bit errors exceed 9999999, then response to query is BRE=9999999.	N/A	BRE?	BRE=xxxxxxx
BERT Result in average BER	N/A	6 bytes	Query only Returns the value of the average BER in the form a.bEc _x , where: x.x=Value Ec=Exponent x=Indicator of Sync Loss (see Note 1). NOTES: 1) A "*" in last byte means there was a loss of pattern synchronization since last restart, but now is synchronized. A " _ " (space) in last byte means pattern synchronization is achieved. 2) Returns 999999 if there's no sync in BERT monitor. EXAMPLE 1: <0/BRR? >0/BRR=2.8E7 (indicates BER @ 2.8 x 10 ⁻⁷ and in sync) EXAMPLE 2: <0/BRR? >0/BRR=3.4E5* (indicates BER @ 3.4 x 10 ⁻⁵ , and there was a Sync Loss)	N/A	BRR?	BRR=x.xEc _x

Parameter	Command (Instruction & Qualifier)	Length of Arguments	Description of Arguments	Response to Command	Query (Instruction & Qualifier)	Response to Query
ACM parameters	ACM=	4 bytes	Command or Query. (Only applicable in VersaFEC ACM and VersaFEC-2 ACM mode.) Sets or returns ACM operating parameters in the form mMAT, where: In VersaFEC ACM (IP-ACM): m=Minimum Tx ModCod, range is 0 thru 9, and A (for ModCod=10) or B (for ModeCod=11) M=Maximum Tx ModCod, range is 0 thru 9, and A (for ModCod=10) or B (for ModeCod=11) A=Action on remote demod unlock (0=go to minimum Tx ModCod, 1=maintain Tx ModCod) T=Target Eb/No Margin, from 0 thru 9 that is two times of the Eb/No in dB (from 0.0dB to 4.5dB). In VersaFEC-2 ACM (V2-ACM): mM=Maximum Tx ModCod in decimal, range is 00-37 for Long Block, and 00-35 for Short Block. A=Action on remote demod unlock (0=go to Tx ModCod 0, 1=maintain Tx ModCod) T=Target Eb/No Margin, from 0 thru 9 that is two times of the Eb/No in dB (from 0.0dB to 4.5dB). EXAMPLE: <0/ACM=0B12 (Sets min ModCod=0, max ModCod=11, maintain Tx ModCod when remote demod unlocks, sets Target Eb/No at 1.0dB.)	ACM= ACM? ACM#	ACM?	ACM=mMAT (see Description of Arguments)
Forced Reboot	FRB=	None	Command only. This command takes no arguments. Forces a hard reset of the unit after 5 seconds.	FRB= FRB? FRB* FRB#	N/A	N/A
Carrier ID State	CAI=	1 byte, 0 or 1	Command or Query. Sets or returns Carrier ID On/Off State in the form x, where: 0=Off 1=On	CAI= CAI? CAI * CAI #	CAI?	CAI =x (see Description of Arguments)
Demo Time Remaining	N/A	6 bytes, numeric	Query only. Returns remaining Demo time in the form ddhhmm, where: dd=days (00 thru 30) hh=hours (00 thru 23) mm=minutes (00 thru 59) EXAMPLE: <0/DMT? >0/DMT=032312 (3 days 23 hours 12 minutes)	N/A	DMT?	DMT=ddhhmm (see Description of Arguments)
Demo Mode	DMM=	1 byte, 0 thru 2	Command or Query. Sets or returns Demo Mode function in the form x, where: 0=Disabled 1=Enabled 2=Expired	DMM= DMM? DMM* DMM#	DMM?	DMM=x (see Description of Arguments)
Medium-Earth Orbit	MEO=	1 byte, 0 or 1	Command or Query. Sets or returns Medium Earth Orbit function in the form x, where: 0=Disabled 1=Enabled	MEO= MEO? MEO* MEO#	MEO?	MEO=x (see Description of Arguments)
Antenna Handover	AHO=	1 byte, 0 or 1	Command or Query. Sets or returns Antenna Handover function in the form x, where: 0=Disabled 1=Enabled	AHO= AHO? AHO#	AHO?	AHO=x (see Description of Arguments)
Antenna Handover Mode	AHM=	1 byte, 0 or 1	Command or Query. Sets or returns Antenna Handover Mode in the form x, where: 0=Manual 1=Auto	AHM= AHM? AHM#	AHM?	AHM=x (see Description of Arguments)

Parameter	Command (Instruction & Qualifier)	Length of Arguments	Description of Arguments	Response to Command	Query (Instruction & Qualifier)	Response to Query
Antenna Handover Differential Path Delay	AHD=	3 bytes	Command or Query. Sets or returns Differential Path Delay in the form sxx, where: s=sign (+ or -) xx=Value, from -13 to +13 EXAMPLE 1: AHD=+12 (Lead 12) EXAMPLE 2: AHD=-03 (Lag 3)	AHD= AHD? AHD* AHD#	AHD?	AHD=sxx (see Description of Arguments)
Antenna Handover Type	AHT=	1 byte, 0 or 1	Command or Query. Sets or returns Antenna Handover Type in the form x, where: 0=Make Before Break 1=Break Before Make	AHT= AHT? AHT#	AHT?	AHT=x (see Description of Arguments)
Time Protocol Enable	TPE=	1 byte, 0 or 1	Command or Query. Sets or returns the Time Protocol, where: 0=Disabled 1=Enabled EXAMPLE: <0/TPE=1 (Time protocol enabled)	TPE= TPE?	TPE?	TPE=x (see Description of Arguments)
Primary Ethernet Time Server	TPS=	15 bytes	Command or Query. Sets or returns the Primary Ethernet Time Server IP Address for the Unit Tx Ethernet management port, in the form aaa.bbb.ccc.ddd, where: aaa=000-223 bbb=000-255 ccc=000-255 ddd=001-255 EXAMPLE: <0/TPS=192.168.001.005	TPS= TPS?	TPS?	TPS=aaa.bbb.ccc.ddd (see Description of Arguments)
Backup Ethernet Time Server	TPB=	15 bytes	Command or Query. Sets or returns the Backup Ethernet Time Server IP Address for the Unit Tx Ethernet management port, in the form aaa.bbb.ccc.ddd, where: aaa=000-223 bbb=000-255 ccc=000-255 ddd=001-255 EXAMPLE: <0/TPB=192.168.001.005	TPB= TPB?	TPB?	TPB=aaa.bbb.ccc.ddd (see Description of Arguments)
Carrier ID Latitude	LAT=	8 bytes	Command or Query. Sets or returns the Carrier ID Latitude, in the form ddaamm.mmbbD, where: dd=degrees Latitude, aaa=fixed value "deg". mm.mm=decimal minutes of the Latitude. Bbb=fixed value "min". D=direction (N (North) or S (South)). EXAMPLE: <0/LAT=33deg59.99minN (Latitude is 33°59.99' N)	LAT= LAT?	LAT?	LAT=ddaaamm.mmbb bD (see Description of Arguments)

Parameter	Command (Instruction & Qualifier)	Length of Arguments	Description of Arguments	Response to Command	Query (Instruction & Qualifier)	Response to Query
Carrier ID Longitude	LNG=	9 bytes	Command or Query. Sets or returns the Carrier ID Longitude, in the form dddaaamm.mmbbbD, where: ddd=degrees Longitude, aaa=fixed value "deg". mm.mm=decimal minutes of the Longitude. bbb=fixed value "min". D=direction (E (East) or W (West)). EXAMPLE: <0/LNG=111deg59.99minE (Longitude is 111°59.99 'E)	LNG= LNG?	LNG?	LNG=dddaamm.mm bbbD {see Description of Arguments
Carrier ID Telephone Number	PHN=	Up to 18 bytes	Command or Query. Sets or returns the Carrier ID Telephone Number (maximum length is 18 characters). EXAMPLE: <0/PHN=18664723963	PHN= PHN?	PHN?	PHN=x {see Description of Arguments
Carrier ID Custom Message	MSG=	Up to 24 bytes	Command or Query. Sets or returns the Carrier ID Custom Message (maximum length is 24 characters). Valid characters include printable ASCII characters from space(0x20) through ~(0x7E) EXAMPLE: <0/MSG=Comtech EF Data	MSG= MSG?	MSG?	MSG=x {see Description of Arguments
Radius Client	RAE=	1 byte, 0 or 1	Command or Query. Sets or returns the RADIUS Client in the form x, where: 0=Disabled 1=Enabled EXAMPLE: <0/RAE=0 NOTE: Parameter available only through Telnet CLI. Command available at Administrator level only.	RAE= RAE? RAE* RAE#	RAE?	RAE=x (see Description of Arguments)
Primary Radius Server IPv4 Address	RAA=	15 bytes	Command or Query. Sets or returns the Primary Radius Server IP Address in the form aaa.bbb.ccc.ddd, where: aaa=000-223 bbb=000-255 ccc=000-255 ddd=001-255 EXAMPLE: <0/RAA=192.168.001.011 NOTE: Parameter available only through Telnet CLI. Command available at Administrator level only.	RAA= RAA? RAA* RAA#	RAA?	RAA=aaa.bbb.ccc.ddd (see Description of Arguments)
Secondary Radius Server IPv4 Address	RAB=	15 bytes	Command or Query. Sets or returns the Secondary Radius Server IP Address in the form aaa.bbb.ccc.ddd, where: aaa=000-223 bbb=000-255 ccc=000-255 ddd=001-255 EXAMPLE: <0/RAB=192.168.001.011 NOTE: Parameter available only through Telnet CLI. Command available at Administrator level only.	RAB= RAB? RAB* RAB#	RAB?	RAB=aaa.bbb.ccc.ddd (see Description of Arguments)
Radius Server Port	RAP=	5 bytes	Command or Query. Sets or returns the RADIUS Server Port in the form xxxxx EXAMPLE: <0/RAP=01812	RAP= RAP? RAP* RAP#	RAP?	RAP=xxxxx (see Description of Arguments)

Parameter	Command (Instruction & Qualifier)	Length of Arguments	Description of Arguments	Response to Command	Query (Instruction & Qualifier)	Response to Query
Radius Server Password Type	RAT=	1 byte, 0 or 1	Command or Query. Sets or returns the RADIUS Server password type in the form x, where 0=PAP 1=CHAP EXAMPLE: <0/RAT=0 NOTE: Parameter available only through Telnet CLI. Command available at Administrator level only.	RAT= RAT? RAT* RAT#	RAT?	RAT=x (see Description of Arguments)
Radius Server Shared Secret	RAS=	Up to 64 bytes	Command or Query. Sets or returns the RADIUS Server shared secret EXAMPLE: <0/RAS=comtech NOTE: Parameter available only through Telnet CLI. Command available at Administrator level only.	RAS= RAS? RAS* RAS#	RAS?	RAS=xxx... (see Description of Arguments)
Precision Time Protocol Transport Mode	PTU=	1 byte	Command or Query. Sets or returns PTP Transport Mode in the form x, where: 0=Multicast 1=Unicast	PTU= PTU? PTU* PTU#	PTU?	PTU=x (see Description of Arguments)
Precision Time Protocol Unicast Master	PTS=	15 bytes	Command or Query. Sets or returns the PTP Unicast Master IP Address in the form xxx.xxx.xxx.xxx.	PTS= PTS? PTS* PTS#	PTS?	PTS=xxx.xxx.xxx.xxx (see Description of Arguments)
Precision Time Protocol Unicast Sync Interval	PTY=	2 bytes	Command or Query. Sets or returns the PTP Unicast Master IP Address in the form xx, where: -6= 64 Messages per second -5= 32 Messages per second -4=16 Messages per second -3=8 Messages per second -2=4 Messages per second -1=2 Messages per second +0=1 Message per second +1=1 Message every 2 seconds (default value)	PTY= PTY? PTY* PTY#	PTY?	PTY=xx (see Description of Arguments)
Port Monitoring Enable	PME=	1 byte	Command or Query. Sets or returns port monitoring in the form x, where: 0=Disabled 1=Enabled NOTE: MAC Learning must be enabled to monitor properly. EXAMPLE: <0/PME=0	PME= PME? PME* PME#	PME?	PME=x (see Description of Arguments)
Port Monitoring Source Port	PMS=	1 byte	Command or Query. Sets or returns the port monitoring source (monitoring) port in the form x, where: 1=Port 1 2=Port 2 3=Port 3 4=Port 4 5=WAN NOTES: 1) Source port and destination port must be different. 2) WAN (5) monitors Packet Processor traffic if it presents. EXAMPLE: <0/PMS=1	PMS= PMS? PMS* PMS#	PMS?	PMS=x (see Description of Arguments)

Parameter	Command (Instruction & Qualifier)	Length of Arguments	Description of Arguments	Response to Command	Query (Instruction & Qualifier)	Response to Query																																														
Port Monitoring Destination Port	PMD=	1 byte	Command or Query. Used to set the port monitoring destination (capturing) port in the form x, where: 1=port 1 2=port 2 3=port 3 4=port 4 EXAMPLE: <0/PMD=1 Source port and destination port must be different.	PMD= PMD? PMD* PMD#	PMD?	PMD=x (see Description of Arguments)																																														
Port Monitoring Direction	PMI=	1 byte	Command or Query. Sets or returns the port monitoring direction in the form x, where: 1=Ingress (Rx) 2=Egress (Tx) 3=Both (Rx and Tx) EXAMPLE: <0/PMI=1	PMI= PMI? PMI* PMI#	PMI?	PMI=x (see Description of Arguments)																																														
Simple Network Time Protocol Time Zone	TPZ=	2 bytes	Command or Query. Sets or returns the SNTP time zone in the form xx, where: <table style="width: 100%; border: none;"> <tr> <td style="width: 50%;">00 = GMT-12:00</td> <td style="width: 50%;">23 = GMT+05:30</td> </tr> <tr> <td>01 = GMT-11:00</td> <td>24 = GMT+05:45</td> </tr> <tr> <td>02 = GMT-10:00</td> <td>25 = GMT+06:00</td> </tr> <tr> <td>03 = GMT-09:00</td> <td>26 = GMT+06:30</td> </tr> <tr> <td>04 = GMT-08:00</td> <td>27 = GMT+07:00</td> </tr> <tr> <td>05 = GMT-07:00</td> <td>28 = GMT+08:00</td> </tr> <tr> <td>06 = GMT-06:00</td> <td>29 = GMT+09:00</td> </tr> <tr> <td>07 = GMT-05:00</td> <td>30 = GMT+09:30</td> </tr> <tr> <td>08 = GMT-04:30</td> <td>31 = GMT+10:00</td> </tr> <tr> <td>09 = GMT-04:00</td> <td>32 = GMT+10:30</td> </tr> <tr> <td>10 = GMT-03:30</td> <td>33 = GMT+11:00</td> </tr> <tr> <td>11 = GMT-03:00</td> <td>34 = GMT+12:00</td> </tr> <tr> <td>12 = GMT-02:30</td> <td>35 = GMT+13:00</td> </tr> <tr> <td>13 = GMT-02:00</td> <td>36 = GMT+14:00</td> </tr> <tr> <td>14 = GMT-0</td> <td></td> </tr> <tr> <td>15 = GMT</td> <td></td> </tr> <tr> <td>16 = GMT+01:00</td> <td></td> </tr> <tr> <td>17 = GMT+02:00</td> <td></td> </tr> <tr> <td>18 = GMT+03:00</td> <td></td> </tr> <tr> <td>19 = GMT+03:30</td> <td></td> </tr> <tr> <td>20 = GMT+04:00</td> <td></td> </tr> <tr> <td>21 = GMT+04:30</td> <td></td> </tr> <tr> <td>22 = GMT+05:00</td> <td></td> </tr> </table> EXAMPLE: <0/TPZ=05	00 = GMT-12:00	23 = GMT+05:30	01 = GMT-11:00	24 = GMT+05:45	02 = GMT-10:00	25 = GMT+06:00	03 = GMT-09:00	26 = GMT+06:30	04 = GMT-08:00	27 = GMT+07:00	05 = GMT-07:00	28 = GMT+08:00	06 = GMT-06:00	29 = GMT+09:00	07 = GMT-05:00	30 = GMT+09:30	08 = GMT-04:30	31 = GMT+10:00	09 = GMT-04:00	32 = GMT+10:30	10 = GMT-03:30	33 = GMT+11:00	11 = GMT-03:00	34 = GMT+12:00	12 = GMT-02:30	35 = GMT+13:00	13 = GMT-02:00	36 = GMT+14:00	14 = GMT-0		15 = GMT		16 = GMT+01:00		17 = GMT+02:00		18 = GMT+03:00		19 = GMT+03:30		20 = GMT+04:00		21 = GMT+04:30		22 = GMT+05:00		TPZ= TPZ? TPZ * TPZ #	TPZ?	TPZ =xx (see Description of Arguments)
00 = GMT-12:00	23 = GMT+05:30																																																			
01 = GMT-11:00	24 = GMT+05:45																																																			
02 = GMT-10:00	25 = GMT+06:00																																																			
03 = GMT-09:00	26 = GMT+06:30																																																			
04 = GMT-08:00	27 = GMT+07:00																																																			
05 = GMT-07:00	28 = GMT+08:00																																																			
06 = GMT-06:00	29 = GMT+09:00																																																			
07 = GMT-05:00	30 = GMT+09:30																																																			
08 = GMT-04:30	31 = GMT+10:00																																																			
09 = GMT-04:00	32 = GMT+10:30																																																			
10 = GMT-03:30	33 = GMT+11:00																																																			
11 = GMT-03:00	34 = GMT+12:00																																																			
12 = GMT-02:30	35 = GMT+13:00																																																			
13 = GMT-02:00	36 = GMT+14:00																																																			
14 = GMT-0																																																				
15 = GMT																																																				
16 = GMT+01:00																																																				
17 = GMT+02:00																																																				
18 = GMT+03:00																																																				
19 = GMT+03:30																																																				
20 = GMT+04:00																																																				
21 = GMT+04:30																																																				
22 = GMT+05:00																																																				

8.5.5 Bulk Configuration Strings

NOTE: In order to completely get/set the configuration of the modem, the following commands must be queried/set:

- MGC
- OGC (L-Band Only)
- Drop and Insert (specified in MGC):
 - DNI (Open Network Drop and Insert);
 - DIC (Closed Network DNI++ Drop and Insert);
 - QDI (Quad Drop and Insert), one for each active port up to a maximum of four.

Parameter	Command (Instruction & Qualifier)	Number of Arguments	Description of Arguments	Response to Command	Query (Instruction & Qualifier)	Response to Query
Global Configuration	MGC=	224 bytes, numerical entries, fixed values, and delimiters	Command or Query. Global Configuration of CDM625, in the form shown in the Response to Query column (to right) where: FFFF.FFFF=Tx Frequency* same as TFQ DDDDD.DDD=TX Data Rate same as TDR G=Tx FEC Type same as TFT Y=Tx Reed-Solomon Type same as TRS R=Tx FEC Rate same as TCR M=Tx Modulation Type same as TMD V=Tx Spectrum Inversion same as TSI S=Tx Scrambler State same as TSC PP.P Tx Power Level same as TPL B=AUPC Enable same as AUP aaa.aa=AUPC Parameter Setup same as APP C=Tx Clock Source same as TCK X=Tx Carrier State same as TXO I=Tx Interface Type same as TIT K=Tx Ternary Code same as TTC N=Tx Framing Mode same as TFM Z=Tx Clock Invert* same as TCI ffff.fff=Rx Frequency* same as RFQ dddd.dd=Rx Data Rate same as RDR g=Rx FEC Type same as RFT y=Rx Reed-Solomon Type same as RRS r=Rx FEC Rate same as RCR m=Rx Modulation Type same as RMD v=Rx Spectrum Inversion same as RSI s=Rx Scrambler State same as RDS www=Rx Sweep Width* same as RSW c=Rx Clock Source same as RCK ll.=Eb/No Alarm Point same as EBA bbbb=Rx Buffer Size same as RBS	MGC= MGC? MGC* MGC#	MGC? MGC?n (where n=0 thru 9. Returns the MGC portion of 1 of 10 stored configurations)	MGC=FFFF.FFFFDDDD DD.DDDGYRMVSPPP. PBaaa.aacXIKNZffff.fff fddddd.dddgymvsww wcll.lbbbbbiknzOEEEE TeeeeeeeeeeeeeWAL QUHHHHhhhhJJJjjjja bcdefxxxxxxxxrrrrr.rr rsssss.ssshgkpmnntt uuu.uuu.uuu.uuu.uuvv v.vv.vv.vvGHJKW AAABBCCCeexEFG GGH

Parameter	Command (Instruction & Qualifier)	Number of Arguments	Description of Arguments	Response to Command	Query (Instruction & Qualifier)	Response to Query
...Global Configuration (cont.)			i=Rx Interface Type k=Rx Ternary Code n=Rx Framing Mode z=Rx Clock Invert* O=EDMAC mode* EEEE=EDMAC Address* T=Unit Test Mode eeeeeeeeeeee=Unit Alarm Mask* W=Hi-Stab Reference choice A=Statistics Sampling Interval L=Rx Terrestrial Alarm Enable Q=Tx Terrestrial Alarm Enable U=ODU Common Enable HHHH=Tx Backward Alarm hhhh=Rx Backward Alarm JJJ=Tx Audio Volume jjjj=Rx Audio Volume a=Drop Type b=Insert Type c=Tx ESC Type d=Rx ESC Type e=Tx Data Invert f=Rx Data Invert A=Tx Sub-Mux on/off* B=Rx Sub-Mux on/off* CC=Tx Sub-Mux Ratio* DD=RX Sub-Mux Ratio* mMAT* rrrr.rrr=TX Symbol Rate* sssss.sss=RX Symbol Rate* h=HSSI handshake control* g=RTS/CTS setting* k=Rx Equalizer Enable p=Power-On/Carrier-Off Enable m=ESC enable nnn=ESC parameters tt=G.703 Clock Extension uuu.uuu.uuu.uu=IP address* vvv.vvv.vvv.vvv=IP gateway address* w=Tx Alpha Filter Rolloff* G=Tx BERT State* H=Tx BERT Pattern* I=BERT 10E-3 Error Insert* J=Rx BERT State* K=Rx BERT Pattern* w=CnC mode* AAA=CnC frequency offset*	same as RIT same as RTC same as RFM same as RCI same as EFM same as ESA same as TST same as MSK same as EFR same as SSI same as RTE same as TTA same as ODU same as TBA same as RBA same as TVL same as RVL same as DTY same as ITY same as TET same as RET same as TDI same as RDI same as TMX same as RMX same as TMR same as RMR same as ACM same as TSR same as RSR same as HHC same as RTS same as REE same as PCO same as ESC same as SCP same as CEX same as IPA same as IPG same as TXA same as BTX same as TBP same as BKE same as BRX same as RBP same as CNM same as CCF		

Parameter	Command (Instruction & Qualifier)	Number of Arguments	Description of Arguments	Response to Command	Query (Instruction & Qualifier)	Response to Query
...Global Configuration (cont.)			BBBCCC=CnC search delays D=CnC PMSI mode ee=Compressed Ethernet port speed E=Attach summary BUC alarm to Tx F=Attach summary LNB alarm to Rx GG=WAN buffer length H=Dedicated Management Port NOTE: Much of the CDM-625A MGC format carries over from the 600/L MGC format, except where "*" indicates the differences. For "*"ee=Compressed Ethernet port speed" Ethernet port speed is compressed from 4 bytes in SEC command to 2 bytes in MGC. The first byte represents speed settings for Ports 1 and ; the second byte represents speed settings for Ports 3 and 4. In each byte, character A through Y is used to represent 25 possible combinations of two port speed. A=00, B=01, C=02, D=03, E=04, F=10, G=11, H=12, I=13, J=14, K=20, L=21, M=22, N=23, O=24, P=30, Q=31, R=32, S=33, T=34, U=40, V=41, W=42, X=43, Y=44. EXAMPLE: BN is converted to 0123, that means Port 1 is AutoNeg, Port 2 is 100Full, Port 3 is 100Half, Port 4 is 10Full.			
OGC Outdoor Unit Global Copy	OGC=	50 Bytes	Command or Query. ODU Global Configuration of CDM-625A, in the form shown in the Response to Query column (to the right), where: aa=BUC Address b=BUC Tx Output Enable x (spare)* d=BUC Power Supply e=BUC 10MHz Reference State xxxxx (spares) gggg=BUC Current - Low Limit hhhh=BUC Current - High Limit xxxx (spares)* i=LNB Power Supply* x (spare)* k=LNB 10MHz Reference ll=LNB Low Alarm Limit nnn=LNB High Alarm Limit FFFFS=TX LO Frequency ffffs=RX LO Frequency xxxxxx (spares) NOTES: 1) Much of the CDM-625A OGC format carries over from the CDM-600L OGC format, except where "*" indicates the differences. In 600L Emulation Mode, the OGC format follows the CDM-600L OGC format. 2) Any unavailable parameters will be filled with x's.	OGC= OGC? OGC* OGC#	OGC? OGC?n (where n=0 thru 9. Returns the OGC portion of 1 of 10 stored configurations)	OGC=aabxdexxxxggg ghhhhxxxxixkllnnnFFF FFSffffsxxxxxx (Returns current OGC Configuration)

Parameter	Command (Instruction & Qualifier)	Number of Arguments	Description of Arguments	Response to Command	Query (Instruction & Qualifier)	Response to Query
Drop & Insert	DNI=	51 bytes	<p>Command or Query. (D&I only)</p> <p>Sets or returns D&I in the form ddddddddddddddddddddddddtiiiiiiiiiiiiiiTL, where:</p> <p>25 bytes of Drop information (dddddddddddddddddddddddt) where: d=24 channels (bytes) defining Drop Timeslot information t=Drop type: 0=T1-D4, 1=T1-ESF, 2=E1-CCS, 3=E1-CAS, as DTY</p> <p>25 bytes of Insert information (iiiiiiiiiiiiiiiiiiT) where: i=24 channels (bytes) defining Insert Timeslot information T=Insert type: 0=T1-D4, 1=T1-ESF, 2=E1-CCS, 3=E1-CAS, as ITY</p> <p>Typical for Drop or Insert Timeslot definition: 0=Unused z=Timeslot 0 (zero) 1-9=Timeslots 1 through 9 A=Timeslot 10 through V=Timeslot 31 L=D&I Internal Loop: 0=OFF, 1=ON</p> <p>EXAMPLE: <0/DNI=123456789ABC00000000000003123456789ABC00000000000031 (Drop channels 1-12 using timeslots 1-12, and unused channels 13-24. Same for Insert. E1-CAS, D&I types, Internal Loop ON).</p> <p>NOTE: If framing is D&I and data rate is 1920 kbps and DNI Type is E1-CCS or E1-CAS, then channels cannot be programmed (i.e. FIXED CHANNEL MODE).The DNI? response will display all 'x' in the time-slot positions.</p>	DNI= DNI? DNI* DNI#	DNI? DNI?n (where n=0 thru 9. Returns the DNI portion of 1 of 10 stored configurations)	DNI=dddddddddddddd DNI?dddddddddtiiiiiiiiiiiiiiTL (see Description of Arguments) (Returns current D&I Configuration)
Drop & Insert Configuration (31 channels)	DIC=	67 bytes	<p>Command or Query. (D&I++ only) (Not available in 600/L Emulation mode)</p> <p>Sets or returns D&I++ in the form ddddddddddddddddddddddddxssssssssssssssssssssssssL where:</p> <p>31 bytes of Drop Information (dddddddddddddddddddx) where: d=31 channels (bytes) defining Drop Timeslot information PLUS xx=spares</p> <p>31 bytes of Insert Information (ssssssssssssssssssssssss) where: s=31 channels (bytes) defining Insert Timeslot information PLUS xx=spares</p> <p>Typical for Drop or Insert Timeslot definition: 0=Unused z=Timeslot 0 (zero) 1-9=Timeslots 1 through 9 A=Timeslot 10 through V=Timeslot 31 L=D&I Internal Loop: 0=OFF, 1=ON</p> <p>EXAMPLE: <0/DIC=123456789ABCDEFGHIJKLMNQRSTUUVxx123456789ABCDEFGHIJKLMNQRSTUUVxx0 (Drop channels 1-32 using timeslots 1-31 and timeslot zero. Same for Insert. E1-CCS, Internal Loop Off.)</p>	DIC= DIC? DIC* DIC#	DIC? DIC?n (where n=0 thru 9. Returns the DIC portion of 1 of 10 stored configurations)	DIC=dddddddddddddd dddddddddddx ssssssssssssssssssssssssL (see Description of Arguments)

Parameter	Command (Instruction & Qualifier)	Number of Arguments	Description of Arguments	Response to Command	Query (Instruction & Qualifier)	Response to Query
Bulk Status Query	N/A	29 bytes Exception – 600 or 600L Emulation: 28 chars, as RFO is different	<p>Query only. Response in the form abcccc,dddd,eeffffffggggghh, where: a=LRS? response b=RED? response cccc=EBN? response dddd=BER? response eeee=BFS? Response * fffff=RFO? response gggg=RSL? response hhh=TMP? response</p> <p>NOTE: This command is intended to <u>reduce</u> the need for excessively frequent queries to a modem, and will be useful for a unit in a redundancy system, where the redundancy system has monitoring of its own occurring. The latter 6 parameters are only updated <u>once per second</u>.</p>	N/A	BSQ?	BSQ=abcccc,dddd,eef ffffffggggghh (see Description of Arguments)

8.5.6 Modem Information

Parameter	Command (Instruction & Qualifier)	Number of Arguments	Description of Arguments	Response to Command	Query (Instruction & Qualifier)	Response to Query
Hardware Revision	N/A	4 bytes	Query only. Returns hardware revision level of both main circuit cards in the form xx.y, where: xx indicates the main (bottom) card; y indicates the top (modem) card.	N/A	HRV?	HRV=xx.y (see Description of Arguments)
Software Revision	N/A	5 bytes	Query only. Returns the installed firmware version number, in the form x.x.x, where: EXAMPLE: <0/SWR? >0/SWR=2.0.2	N/A	SWR?	SWR=x.x.x (see description of arguments)
Firmware Information	N/A	256 bytes	Query only. Returns the installed firmware information. NOTE: <0/FRW?B requests boot code information. EXAMPLE: FRW=Boot: FW-0020732-,1.1.1,01/08/13 Otherwise, FRW returns firmware information for Image 1 or 2: EXAMPLE: <0/FRW? >0/FRW=1:FW-0020731E,1.3.1L,07/10/14 FW-0020733C,1.3.1L,07/10/14 FW/12867AG ,2.3.3,28/07/14 FW/12868L ,2.3.1,15/04/13 FW-0020735B,1.3.1,11/09/14 FW/12874C ,1.6.0,15/08/11 FW-0020734D ,1.3.1,07/10/14 FW-0020739-,1.1.1,24/07/13 FW-0000516-,1.1.1,19/01/11 FW-0020740v,1.1.v,06/08/14	N/A	FRW?B FRW?1 FRW?2	FRW=xxx...xxx (see Description of Arguments)
Serial Number	N/A	9 bytes	Query only. Returns the modem 9-digit serial number. EXAMPLE: <0/SNO? >0/SNO=176500143	N/A	SNO?	SNO=xxxxxxxx (see Description of Arguments)
Fractional CnC 90-day Counter	N/A	7 bytes	Query Only. Returns the number of seconds that Fractional CnC license has been used in the 1-year period since the last reset of the CnC counter to 0. EXAMPLE: <0/FCC? >0/FCC=0000455 (indicating 455 seconds)	N/A	FCC?	FCC=xxxxxxx (see Description of Arguments)
Modem Operational Full Year Counter	N/A	8 bytes	Query Only. Returns the number of seconds that the unit has been powered on since the last reset of the CnC counter. The counter resets to 0 when it reaches 31536000 seconds (seconds in 365 days). EXAMPLE: <0/FCF? >0/FCF=00001342 (indicating 1342 seconds)	N/A	FCF?	FCF=xxxxxxx (see Description of Arguments)
Software Revision 2	N/A	38 bytes	Query only. Returns the installed firmware version numbers in the Boot, Image 1, and Image 2 slots. EXAMPLE: <0/SW2? >0/SW2=Boot:2.1.1 Bulk1*:2.1.2 Bulk2 :2.1.1 The current active image is indicated with an asterisk.	N/A	SW2?	SW2=x (see Description of Arguments)

Parameter	Command (Instruction & Qualifier)	Number of Arguments	Description of Arguments	Response to Command	Query (Instruction & Qualifier)	Response to Query
Equipment ID	N/A	33 bytes	<p>Query only.</p> <p>Returns the equipment ID and installed options in the form AAAABCDEFHsJKLMNPQRSTUVWXYZabods, where: AAAA=A625, the modem model number</p> <p>Installed hardware:</p> <p>B=Slot 1: TPC/LDPC codec, where: 0=not present 1=present</p> <p>C=0 (Reserved for Expansion board)</p> <p>D=VersaFEC-2 board, where: 0=not present 1=present</p> <p>E=Slot 4: Network Processor card, where: 0=not present 1=present</p> <p>F=spare (0)</p> <p>G=External 20dB attenuator, where: 0=not present 1=present</p> <p>H=Audio chips, where: 0=not present 1=present</p> <p>s=spares (0)</p> <p>Firmware FAST options:</p> <p>J=Frequency option, where: 0=70/140MHz 1=70/140MHz & L-Band</p> <p>K=Modulation option, where: 0=Standard: BPSK, QPSK, OQPSK. 1=Standard plus 8-ARY 3=Standard plus 8-ARY and 16-ARY 7=Standard plus 8-ARY, 16-ARY and 32-ARY</p> <p>L=Data Rate option M=TPC/LDPC data rate option</p> <p>For L and M, the value is decoded:</p> <p>0=Base, up to 5Mbps 1=up to 10Mbps 2=up to 15 Mbps 3=up to 20Mbps 4=up to 25Mbps</p> <p>N=CnC data rate option, where: 0=No CnC FAST installed 1=up to 512kbps 2=up to 1.1Mbps 3=up to 2.5 Mbps 4=up to 5 Mbps 5=up to 10 Mbps 6=up to 15 Mbps</p>	N/A	EID?	EID=AAAABCDEFHsJKLMNPQRSTUVWXYZabods (see Description of Arguments)

Parameter	Command (Instruction & Qualifier)	Number of Arguments	Description of Arguments	Response to Command	Query (Instruction & Qualifier)	Response to Query
...Equipment ID (cont.)			<p>7=up to 20 Mbps 8=up to 25 Mbps P=VersaFEC CCM data rate option, where: 0=No VersaFEC CCM FAST installed 1=up to 1.1Mbps 2=up to 2.5Mbps 3=up to 5 Mbps 4=up to 16Mbps Q=IP-ACM symbol rate option, where: 0=None 1=up to 300ksym/sec 2=up to 1200ksym/sec 3=up to 4100ksym/sec R=Framing option, where: 0=Standard: (Unframed, EDMAC, EDMAC2) 1=Option 0 plus Open Network (IBS with hi-rate ESC, IDR, Audio) S=D&I option, where: 0=None 1=D&I,D&I++ for single port E1/T1 2=Option 1 plus Quad D&I (4 ports) T=G.703 Clock Extension, where: 0=Not installed 1=installed on U=Time based CnC option, where: 0=Not installed 1=Fractional CnC installed 2=Time Limited CnC installed 3=Option 1 and Option 2 V=Header Compression, where: 0=None 1=up to 5Mbps / 2000ksps (ACM) 2=up to 10Mbps / 4100ksps (ACM) 3=up to 15Mbps / 8000ksps (ACM) 4=up to 20Mbps / 12500ksps (ACM) 5=up to 25Mbps / 12500ksps (ACM) W=Payload Compression, where: 0=None 1=up to 5Mbps / 2000ksps (ACM) 2=up to 10Mbps / 4100ksps (ACM) 3=up to 15Mbps / 8000ksps (ACM) 4=up to 20Mbps / 12500ksps (ACM) 5=up to 25Mbps / 12500ksps (ACM) X=Advanced QoS, where: 0=Not installed 1=Installed</p>			

Parameter	Command (Instruction & Qualifier)	Number of Arguments	Description of Arguments	Response to Command	Query (Instruction & Qualifier)	Response to Query
...Equipment ID (cont.)			<p>Y=AES Encryption, where: 0=Not installed 1=Installed</p> <p>Z=Advanced NetworkTiming, where: 0=Not installed 1=Installed</p> <p>a=Carrier ID, where: 0=Not installed 1=Installed</p> <p>b=CnC Activation, where: 0=Not installed 1=Installed</p> <p>c=VersaFEC-2 CCM data rate option, where: 0=Base, up to 5Mbps 1=up to 10 Mbps 2=up to 15 Mbps 3=up to 20 Mbps 4=up to 25 Mbps</p> <p>d=VersaFEC-2 ACM symbol rate option, where: 0=None 1=up to 1200 ksps 2=up to 2000 ksps 3=up to 4100 ksps 4=up to 8000 ksps 5=up to 12500 ksps s=spares (0)</p> <p>600/L Emulation: See CDM-600/600L manual EXAMPLE: <0/EID=A62510110010174484312105511111450 indicates all firmware options, TPC/LDPC card installed, VersaFEC-2 card installed, and Network Processor card installed. NOTE: To achieve LDPC or TPC to 25 Mbps, the modem requires:</p> <ul style="list-style-type: none"> • Hardware option B, slot 1, a TPC/LDPC Codec; • Firmware options: L: data rate FAST option to 25 Mbps AND M:TPC/LDPC data rate FAST option to 25 Mbps. 			

8.5.7 Modem Performance Information

Parameter	Command (Instruction & Qualifier)	Number of Arguments	Description of Arguments	Response to Command	Query (Instruction & Qualifier)	Response to Query
Rx Signal Level	N/A	5 bytes	Query Only. Returns the value of the Rx signal level in the form xxxxx, where: xxxxx=Value, in dBm, from -20 thru -90. NOTE: If >-20 dBm, returns RSL=GT-20 (GT='greater than') If <-90 dBm, returns RSL=LT-90 (LT='less than') If in the range of -20 thru -90dBm, returns RSL=-xx.y (resolution=0.5dB) EXAMPLE: <0/RSL? >0/RSL=-45.5 (indicates -45.5 dBm)	N/A	RSL?	RSL=xxxxx (See Description of Arguments)
Rx Frequency Offset	N/A	6 bytes Exception – 600L Emulation: 5 bytes	Query only. Returns the value of the measured frequency offset of the carrier being demodulated, in the form sxxx.x, where: s=sign (+ or -) xxx.x=Value, in kHz, from ± 0 thru ± 200. Resolution=100 Hz NOTES: 1) Returns 999999 if the demodulator is unlocked. 2) The maximum Rx Frequency Offset corresponds to the Receive Sweep Width (RSW) EXAMPLE: <0/RFO? >0/RFO=+002.3 (indicates +2.3 kHz)	N/A	RFO?	RFO=sxxx.x (See Description of Arguments)
Buffer Fill State	N/A	2 bytes, numeric	Query only. Returns the value of the buffer fill state in the for xx, where: xx=Percentage value from 01 to 99 NOTE: Returns 00 if demodulator is unlocked. EXAMPLE: <0/BFS? >0/BFS=33 (indicates 33%)	N/A	BFS?	BFS=xx (See Description of Arguments)
Rx BER	N/A	5 bytes	Query only. Returns the value of the estimated corrected BER in the form x.xEc, where: x.x=Value Ec=Exponent NOTE: Returns 99999 if the demodulator is unlocked or BER data is unavailable. EXAMPLE: <0/BER? >0/BER=4.8E3 (indicates BER @ 4.8 x 10 ⁻³)	N/A	BER?	BER=x.xEc (See Description of Arguments)
Rx Eb/No	N/A	4 bytes	Query only. Returns the value of Eb/No in the form xx.x, where: xx.x=Value, in dB, from 00 or 16 Resolution=0.1 dB NOTE: Returns 99.9 if demod is unlocked; returns +016 for values greater than 16.0 dB. EXAMPLE: <0/EBN? >0/EBN=12.3 (indicates Eb/No @12.3 dB)	N/A	EBN?	EBN=xxxx (see Description of Arguments)
Redundancy State	N/A	1 byte, 0 or 1	Query only. Returns the redundancy state of the unit in the form x, where: 0=Offline 1=Online EXAMPLE: <0/RED? >0/RED=1 (indicates redundancy state as Online)	N/A	RED?	RED=x (See Description of Arguments)
Temperature	N/A	3 bytes	Query only. Returns the value of the internal temperature sensor (degrees C) in the form sxx, where: EXAMPLE: <0/TMP? >0/TMP=+26	N/A	TMP?	TMP=sxx (see Description of Arguments)

Parameter	Command (Instruction & Qualifier)	Number of Arguments	Description of Arguments	Response to Command	Query (Instruction & Qualifier)	Response to Query
Offline Unit Status	N/A	8 bytes	<p>Query only. (1:1 set-up)</p> <p>This query is sent to the online modem of a 1:1 pair. It provides access to the fault status information (FLT?) of the offline modem. This is the only way to interrogate the status of an offline modem at the distant-end of a link. The response format may be:</p> <p>No_1for1=Indicates that no 1:1 system has been detected. Presence of a 1kHz signal from the CRS-150 is used to indicate a 1:1 set-up;</p> <p>No_Comms=Indicates that a 1kHz signal has been detected, but that there is no (or not yet) a response for the modem;</p> <p>abcdef=The FLT? response information from the offline 600L unit; or</p> <p>abcdefghxx=The FLT? response information from the offline CDM-625A unit.</p>	N/A	OUS?	OUS=xxxxxx (see Description of Arguments)
Faults and Status	N/A	10 bytes	<p>Query only.</p> <p>Returns the current <i>highest-priority</i> fault and status codes for the Unit (hardware), TX Traffic, RX Traffic, and ODUs:</p> <p>a=Unit status:</p> <p>0=No faults 1=Power supply fault, +5 volts 2=Power supply fault, +12 volts 3=Power supply fault, -5 volts 4=Power supply fault, +3.3 volts 5=Power supply fault, -12 volts 6=Power supply fault, +2.5 volts 7=Top Card comms 8=Tx synthesizer lock 9=Rx synthesizer A=Top card load fail B=TPC/LDPC FPGA load fail C=HDLC FPGA load fail D=CnC FPGA load fail E=VersaFEC FPGA load fail F=Calibration data missing</p> <p>Exception – 600L: F=Rx synthesizer2</p> <p>G=Reference unlocked (Note: Tx off) H=TXDCM fail I=Over Temperature Alarm J=Packet Processor mailbox fault K=Fractional CnC use only L=Top Card 3.6 Volt fault M=Top Card 5.5 Volt fault N=Calibration data transfer error P=VersaFEC-2 FPGA load fail</p> <p>b=Tx Traffic status:</p> <p>0=Tx traffic OK 1=No clock from terrestrial interface 2=Tx FIFO slip 3=AIS detected on incoming data 4=AUPC upper limit reached 5=(Hi-Stab) No External Ref found (no activity) 6=BUC summary alarm (if ABA enabled) 7=G.703 Loss of Signal (only valid in Clock Extend Mode)</p>	N/A	FLT?	FLT=abcdefghxx (see Description of Arguments)

Parameter	Command (Instruction & Qualifier)	Number of Arguments	Description of Arguments	Response to Command	Query (Instruction & Qualifier)	Response to Query
...Faults and Status (cont.)			<p>Exceptions – 600L: 6=BUC current 7=BUC voltage 8=BUC no comms/bad checksum 9=BUC PLL A=BUC temperature</p> <p>8=CnC-APC home state 9=PMSI Sym Clock Fail</p> <p>c=Rx Traffic status: 0=Rx Traffic OK 1=Demodulator unlocked 2=AGC Alarm - signal out of range 3=Demux Lock (Frame SYNC) 4=CnC Lock 5=Buffer Slip 6=AIS detected on incoming data 7=Eb/No alarm 8=Buffer Clock activity 9=LNB summary alarm (if ALA enabled) A=QDI Deframer Unlocked</p> <p>Exception – 600L: 9=LNB current A=LNB voltage B,C,D,E,F=Spare G=CnC-APC band mismatch</p> <p>d=Open Network: 0=No Faults 1=Loss of Tx frame 2=BER Alarm 3=Loss of Tx multiframe 4=Tx signaling AIS 5=Tx Remote alarm 6=IBS satellite alarm 7=IDR Rx BWA1 8=IDR Rx BWA2 9=IDR Rx BWA3 A=IDR Rx BWA4 B=IDR Tx BWA1 C=IDR Tx BWA2 D=IDR Tx BWA3 E=IDR Tx BWA4</p> <p>e=Change in modem fault status since last poll 0=unchanged 1=changed</p> <p>f=Change in modem configuration since last poll 0=unchanged 1=changed</p> <p>g=BUC status/faults: 0=OK, masked, or not present 1=BUC current 2=BUC voltage 3=spare</p>			

Parameter	Command (Instruction & Qualifier)	Number of Arguments	Description of Arguments	Response to Command	Query (Instruction & Qualifier)	Response to Query
...Faults and Status (cont.)			<p>4=BUC no comms/bad checksum 5=BUC PLL 6=BUC temperature</p> <p>h=LNB status/faults: 0=OK, masked, or not present 1=LNB current 2=LNB voltage</p> <p>xx=spares</p>			
CnC Ratio Monitor	N/A	4 bytes	<p>Query only. When CnC is enabled and the modem is locked, ratio (in dB) is monitored between the interferer and the desired power.</p> <p>EXAMPLE 1: <0/CRM? >0/CRM=+02 (interferer > desired) (format=sdd) EXAMPLE 2: <0/CRM? >0/CRM=LT11 (less than -11 dB) EXAMPLE 3: <0/CRM? >0/CRM=GT11 (greater than +11 dB) EXAMPLE 4: <0/CRM? >0/CRM=99.9 (not locked or CnC not enabled) EXAMPLE 5: <0/CRM? >0/CRM=AUTO (in CnC-APC mode)</p>	N/A	CRM?	CRM=xxxx (see Description of Arguments)
CnC Delay Monitor	N/A	6 bytes	<p>Query only. When CnC is enabled and the modem is locked, delay (in microseconds) of the interferer is monitored.</p> <p>EXAMPLE 1: <0/CDM? >0/CDM=229500 (229.5 ms) EXAMPLE 2: <0/CDM? >0/CDM=999999 (not locked or CnC not enabled)</p>	N/A	CDM?	CDM=xxxxxx (see Description of Arguments)
CnC Freq Offset Monitor	N/A	6 bytes	<p>Query only. When CnC is enabled, an estimated frequency offset (in kHz) is calculated between the interferer and the desired power.</p> <p>EXAMPLE 1: <0/CFM? >0/CFM=+001.0 (1 kHz) EXAMPLE 2: <0/CFM? >0/CFM=9999.9 (not locked or CnC not enabled)</p>	N/A	CFM?	CFM=xxxx.x (see Description of Arguments)
CnC Power Ratio Monitor	N/A	6 bytes	<p>Query only. When CnC is enabled and the modem is locked, ratio (in dB) between the interferer and the desired power is monitored.. The precision is 0.1dB.</p> <p>EXAMPLE 1: <0/CPR? >0/CPR=+02.8 (interferer > desired) (format=sdd.d) EXAMPLE 2: <0/CPR? >0/CPR=LT11.0 (less than -11.0 dB) EXAMPLE 3: <0/CPR? >0/CPR=GT19.0 (greater than +19.0 dB) EXAMPLE 4: <0/CPR? >0/CPR=9999.9 (not locked or CnC not enabled) EXAMPLE 5: <0/CPR? >0/CPR=AUTO (in CnC-APC mode)</p>	N/A	CPR?	CPR=xxxxxx (see Description of Arguments)
CnC PSDR	N/A	5 bytes	<p>Query only. When CnC is enabled and the modem is locked, ratio (in dB) between the interferer and the desired power is monitored. The precision is 0.1dB.</p> <p>EXAMPLE 1: <0/PSD? >0/PSD=+02.8 (interferer > desired) (format=sdd.d) EXAMPLE 2: <0/PSD? >0/PSD=999.9 (not locked or CnC not enabled) EXAMPLE 3: <0/PSD? >0/PSD=AUTO (in CnC-APC mode)</p>	N/A	PSD?	PSD=xxxx (see Description of Arguments)
CnC-APC Bit Error Rate	N/A	4 bytes	<p>Query only. Returns the value of CnC-APC BER in the form xEc, where: x=value Ec=Exponent BER is measured in frame UW.</p> <p>EXAMPLE: <0/ABE? >0/ABE=8E5 (indicates CnC-APC BER @ 8 x 10⁻⁵) NOTE: Returns 9999 if modem is not in CnC-APC mode or there is an APC frame sync error.</p>	N/A	ABE?	ABE=xEc

Parameter	Command (Instruction & Qualifier)	Number of Arguments	Description of Arguments	Response to Command	Query (Instruction & Qualifier)	Response to Query
CnC-APC BER Reset	ABR=	None	Command only. This command takes no arguments. Forces restart of the CnC-APC BER measurement.	ABR=	N/A	N/A
CnC-APC Frame Error Rate	N/A	4 bytes	Query only. Returns the value of CnC-APC FER in the form xEc, where: x=Value Ec=Exponent EXAMPLE: <0/AFE? >0/AFE=8E2 (indicates CnC-APC FER @ 8 x 10 ⁻²) NOTE: Returns 9999 if modem is not in CnC-APC mode or there is an APC frame sync error.	N/A	AFE?	AFE=xxxx
CnC-APC FER Reset	AFR=	None	Command only. This command takes no arguments. Forces restart of the CnC-APC FER measurement.	AFR=	N/A	N/A
CnC-APC Activate/Suspend	APC=	1 byte, 0 thru 2	Command only. Used to activate or suspend APC operation, in format APC=x, where: 0=no action 1=Activate APC 2=Suspend APC	APC=	N/A	N/A
CnC-APC state	N/A	2 bytes	Query only. Returns the state of APC operation. Return value is in form xx, where: 00=APC is not active 01=No Solution 02=OK - ReBalance Done 03=OK(Partial) - CnC Ratio approaches limit 04=OK(Partial) - Local power approaches minimum value (-25 dBm for IF band) 05=OK(Partial) - Local power approaches minimum value (-40 dBm for L-Band) 06=OK(Partial) - Local power approaches maximum value (0 dBm) 07=OK(Partial) - Local power approaches limit set by max power level increase 08=OK(Partial) - Distant power approaches minimum value (-25 dBm for IF band) 09=OK(Partial) - Distant power approaches minimum value (-40 dBm for L-Band) 10=OK(Partial) - Distant power approaches maximum value (0 dBm) 11=OK(Partial) - Distant power approaches limit set by max power level increase 12=OK(Partial) - Incomplete 13=No APC Frame Sync 14=CnC Ratio Problem 15=Local EbNo too high 16=Distant EbNo too high 17=Distant End ReBalance failed 18=Distant End NoResponse 19=Fail-Calculate Mismatch 20=CnC Ratio too high 21=Please run again 22=APC is active 23=Local margin too low 24=Distant margin too low 25=Rx Data Rate<64kbps 26=Tx Data Rate<64kbps 27=Local RSL too low 28=Distant RSL too low	N/A	APS?	APS=xx

Parameter	Command (Instruction & Qualifier)	Number of Arguments	Description of Arguments	Response to Command	Query (Instruction & Qualifier)	Response to Query
CnC-APC Max Power Level Increase	APL=	3 bytes	Command or Query. CnC-APC maximum power level increase in the form x.x, range from 0.0 thru 9.9 dB, limited by Tx power level. EXAMPLE: <0/APL=3.9 (APC max power level increase is 3.9 dB.)	APL= APL? APL* APL#	APL?	APL=xx.x (see Description of Arguments)
CnC-APC Home State	AHS=	12 bytes	Command or Query. Command is only for Offline unit in Redundancy system, sent by 1:N switch or Online unit in 1:1 system. Returns CnC-APC home state parameters in the form a,bbb,cc,ddd, where: a=APC state: 1=APC is active, 0=APC is not active bbb=APC home state Tx power, in 0.1dB. (minus sign assumed) cc=APC home state max power level increase, in 0.1 dB. ddd=APC Tx power threshold, in 0.1 dB. (minus sign assumed) EXAMPLE: <0/AHS=1,100,60,085 (APC is active, home state power is -10.0 dB, home state max power level increase is 6.0 dB, power threshold is -8.5 dB)	AHS= AHS? AHS* AHS#	AHS?	AHS=a,bbb,cc,ddd (see Description of Arguments)
ACM Remote Signal Noise Ratio	N/A	4 bytes	Query only. Returns the value of SNR of the remote demod in the form xx.x, where: 99.9=Demod is unlocked. xx.x=Not in ACM. EXAMPLE: <0/RSN? >0/RSN=12.4	N/A	RSN?	RSN=xx.x (see Description of Arguments)
ACM Local Signal Noise Ratio	N/A	4 bytes	Query only. Returns the value of Local Signal Noise Ratio in the form xx.x, where: 99.9=demod is unlocked. xx.x=Not in ACM (resolution=0.1 dB) EXAMPLE: <0/SNR? >0/SNR=12.3 (indicates SNR @12.3 dB)	N/A	SNR?	SNR=xx.x (see Description of Arguments)
Uncorrected BER	N/A	7 or 8 bytes	Query only. Units returns the value of the uncorrected BER. LT=less than GT=greater than Returns 9999999 if the demodulator is unlocked or uncorrected BER data is unavailable. EXAMPLE: <0/BER? >0/BER=4.3E-02 or >0/BER=GT1.0E-1	N/A	RBE?	RBE=xxxxxxx (See Description of Arguments)

8.5.8 BUC Parameters (L-Band Device)

Parameter	Command (Instruction & Qualifier)	Number of Arguments	Description of Arguments	Response to Command	Query (Instruction & Qualifier)	Response to Query
BUC Power Supply enable	BPS= Exception – 600L fn: ODP=	1 byte, 0 or 1	Command or Query. Sets or returns BUC Power Supply control in the form x, where: 0=Disable the BUC DC Power Supply 1=Enable the BUC DC Power Supply	BPS= BPS? BPS* BPS#	BPS? Exception – 600L Emulation: ODP?	BPS=x (see Description of Arguments)
BUC 10 MHz Reference	BFR= Exception – 600L Emulation: ODR=	1 byte	Command or Query. Sets or returns BUC 10 MHz Reference the form x, where: 0=OFF 1=ON	BFR= BFR? BFR* BFR#	BFR? Exception – 600L Emulation: ODR?	BFR=x (see Description of Arguments)
BUC Current Low Limit	BCL= Exception – 600L Emulation: ODL=	4 bytes	Command or Query. Sets or returns BUC Current Low Limit, in the form xxxx, where: xxxx=Value, in 100 mA increments, from 0000 thru 4000 mA	BCL= BCL? BCL* BCL#	BCL? Exception – 600L Emulation: ODL?	BCL=xxxx (see Description of Arguments)
BUC Current High Limit	BCH= Exception – 600L Emulation: ODH=	4 bytes	Command or Query. Sets or returns BUC Current High Limit, in the form xxxx, where: xxxx=Value, in 100 mA increments, from 0000 thru 4000 mA	BCH= BCH? BCH* BCH#	BCH? Exception – 600L Emulation: ODH?	BCH=xxxx (see Description of Arguments)
BUC Address	BAD= Exception – 600L Emulation: OAD=	1 byte, 1 thru 15	Command or Query. Sets or returns BUC Address in the form xx, where: xx=Value 01-15. NOTE: This command is only valid when the FSK is enabled.	BAD= BAD? BAD* BAD#	BAD? Exception – 600L Emulation: OAD?	BAD=xx (see Description of Arguments)
BUC Output Power Enable	BOE= Exception – 600L Emulation: OOP=	1 byte, 0 or 1	Command or Query. Sets or returns BUC Tx Carrier Output Power function in the form x, where: 0=OFF 1=ON NOTE: This command is only valid when the FSK is enabled.	BOE= BOE? BOE* BOE#	BOE? Exception – 600L Emulation: OOP?	BOE=x (see Description of Arguments)
BUC DC Current	N/A	4 bytes	Query only. Returns BUC DC current in the form xxxx, where: xxxx=Value, in mA, from 0000 and 9999. NOTE: If not available, response is 0000.	N/A	BDC? Exception – 600L Emulation: ODC?	BDC=xxxx (see Description of Arguments)
BUC Voltage	N/A	4 bytes	Query only. Returns BUC Voltage in the form xx.x, where: xx.x=Value, in volts, from 00.0 thru 64.0	N/A	BDV? Exception – 600L Emulation: ODV?	BDV=xx.x (see Description of Arguments)
BUC Output Power Level	N/A	4 bytes	Query only. Returns BUC Output Power Level in the form xx.x, where: xx.x=Value, in dBm. NOTE: Returns xxxx when FSK is not enabled. EXAMPLE: <0/BOL? >0000/BOL=37.4	N/A	BOL? Exception – 600L Emulation: OOL?	BOL=xx.x (see Description of Arguments)

Parameter	Command (Instruction & Qualifier)	Number of Arguments	Description of Arguments	Response to Command	Query (Instruction & Qualifier)	Response to Query
BUC Temperature	N/A	4 bytes	Query only. Returns BUC Temperature in the form sxxx, where: s=sign (+ or -) xxx=value NOTE: This query is only valid when the FSK and BUC power are turned On.	N/A	BUT? Exception – 600L Emulation: ODT?	BUT=sxxx (see Description of Arguments)
BUC Phase Lock Loop	N/A	1 byte, 0 or 1	Query only. Returns BUC phase lock loop in the form x, where: 0=Locked 1=Unlocked NOTE: This query is only valid when the FSK is enabled.	N/A	BPA? Exception – 600L Emulation: OLL?	BPA=x (see Description of Arguments)
BUC Software Version	N/A	2 bytes	Query only. Returns BUC firmware version in the form xx, where: xx=Value from 00 or 15. NOTE: This query is only valid when the FSK and BUC power are turned On.	N/A	BSV? Exception – 600L Emulation: OSV?	BSV=xx (see Description of Arguments)
BUC Power Class	N/A	2 bytes	Query only. Returns BUC Power Class in the form xx, where: xx=Power Class, in watts. NOTE: This query is only valid when the FSK is enabled. EXAMPLE: <0/BPC? >0000/BPC=25	N/A	BPC? Exception – 600L Emulation: OPC?	BPC=xx (see Description of Arguments)

8.5.9 LNB Parameters (L-Band Device)

Parameter	Command (Instruction & Qualifier)	Number of Arguments	Description of Arguments	Response to Command	Query (Instruction & Qualifier)	Response to Query
LNB DC Power Control	LPS= Exception – 600L Emulation: LNB & LNV	1 byte, 0 thru 3	Command or Query. Sets or returns LNB DC Power Supply Control in the form x, where: 0=OFF 1=13V LNB Voltage 2=18V LNB Voltage 3=24V LNB Voltage	LPS= LPS? LPS* LPS#	LPS? Exception – 600L Emulation: LNB & LNV	LPS=x (see Description of Arguments)
LNB Reference Enable	LNR=	1 byte, 0 or 1	Command or Query. Sets or returns LNB Reference in the form x, where: 0=Disable LNB Reference 1=Enable LNB Reference	LNR= LNR? LNR* LNR#	LNR?	LNR=x (see Description of Arguments)
LNB Low Current Limit	LNL=	3 bytes, numeric	Command or Query. Sets or returns LNB Low Current Limit in the form xxx, where: xxx=Value, in mA, from 000 thru 500.	LNL= LNL? LNL* LNL#	LNL?	LNL=xxx (see Description of Arguments)
LNB High Current Limit	LNH=	3 bytes, numeric	Command or Query. Sets or returns LNB High Current Limit in the form xxx, where: xxx= Value, in mA, from 000 thru 500	LNH= LNH? LNH* LNH#	LNH?	LNH=xxx (see Description of Arguments)
LNB Current	N/A	4 bytes, numeric	Query only. Returns LNB Current in the form xxxx, where: xxxx=Value, in mA.	N/A	LNC?	LNC=xxxx (see Description of Arguments)
LNB Voltage	N/A	4 bytes, numeric	Query only. Returns LNB Voltage in the form xxxx, where: xxxx=Value, in volts.	N/A	LVO?	LVO=xxxx (see Description of Arguments)

8.5.10 Ethernet Parameters

Parameter	Command (Instruction & Qualifier)	Number of Arguments	Description of Arguments	Response to Command	Query (Instruction & Qualifier)	Response to Query
Ethernet Control	SEC=	31 bytes	Command or Query. Sets or returns Ethernet control in the form 1abbbbc;2abbbbc;3abbbbc;4abbbbc, where: 1, 2, 3, 4 is port number. a=Reserved, default to 1. bbb=Reserved, default to 0001. c=port speed: 0=Auto 1=100 Full 2=100 Half 3=10 Full 4=10 Half	SEC= SEC? SEC* SEC#	SEC?	SEC=1abbbbc;2abbbbc;3abbbbc;4abbbbc (see Description of Arguments)
Actual Negotiated Port Speed	N/A	None	Query only. Returns the actual negotiated port speed in the form abcd, where: a=port 1 negotiated port speed. b=port 2 negotiated port speed. c=port 3 negotiated port speed. d=port 4 negotiated port speed. a, b, c, d have the following values: 0=Link down 1=100 Full 2=100 Half 3=10 Full 4=10 Half	N/A	NPS?	NPS=abcd (see Description of Arguments)
Ethernet Global Configuration	EGC=	Up to 347 bytes	Command or Query. Sets or returns Global Configuration of CDM-625A Ethernet, in the form shown in the Response to Query column, where: 1abcccdxxx;2abcccdxxx;3abcccdxxx;4abcccdxxx=Switch Ports configuration D=VLAN Mode Enable E=Switch MAC Learning FF=QoS Priority G=Ethernet 2048 Frame Size H=Precision Time Protocol Feature I=Precision Time Protocol Mode J= Precision Time Protocol Transport Mode KKK.KKK.KKK.KKK= PTP Unicast Master LL= Precision Time Protocol Unicast Sync Interval M= SNTP Enable NNN.NNN.NNN.NNN= SNTP Primary Server OOO.OOO.OOO.OOO= SNTP Backup Server PP= SNTP Time Zone QQQQ=Management VLAN ID RRRR...=VLAN Table	EGC= EGC? EGC* EGC#	EGC? EGC?n (where n=0 thru 9. Returns the EGC portion of 1 of 10 stored configurations)	EGC=1abcccdxxx;2abcccdxxx;3abcccdxxx;4abcccdxxx;DEFF GHIJKKK.KKK.KKKLL MNNN.NNN.NNN.NN NOOO.OOO.OOO.O OOPPQQQRRRR... (see Description of Arguments)

Parameter	Command (Instruction & Qualifier)	Number of Arguments	Description of Arguments	Response to Command	Query (Instruction & Qualifier)	Response to Query
WAN Buffer Length	WBL=	3 bytes	Command or Query. Sets or returns WAN Buffer Length in the form xxx, where: xxx=Value, in 20 millisecond steps, from 020 thru 780. EXAMPLE: <0/WBL=100	WBL= WBL? WBL* WBL#	WBL?	WBL=xxx (see Description of Arguments)
Average WAN Buffer Fill State	N/A	2 bytes, numeric	Query only. Returns the value of Average WAN buffer fill state in the form xx, where: xx=percentage value, from 00 thru 99(%. EXAMPLE: <0/WBF? >0000/WBF=33 (indicates fill state at 33%)	N/A	WBF?	WBF=xx (see Description of Arguments)
Switch MAC Learning	SML=	1 byte, 0 or 1	Command or Query. Sets or returns Switch MAC learning in the form x, where: 0=Off 1=On	SML= SML? SML* SML#	SML?	SML=x (see Description of Arguments)
VLAN Mode Enable	SVM=	1 byte, 0 or 1	Command or Query. Sets or returns VLAN Mode in the form x, where: 0=VLAN is Disabled 1=VLAN is Enabled	SVM= SVM? SVM* SVM#	SVM?	SVM=x (see Description of Arguments)
VLAN Table	SVT=	Up to 287 bytes	Command or Query. Sets or returns all entries in the VLAN table in the form aaaabcde,aaaabcde,aaaabcde,..., where: aaaa=VLAN ID: Value range=0001-4095, must not be duplicate of any PVID. b=property of port 1: 0=Tagged, 1=Filtered, 2=Untagged c=property of port 2: 0=Tagged, 1=Filtered, 2=Untagged d=property of port 3: 0=Tagged, 1=Filtered, 2=Untagged e=property of port 4: 0=Tagged, 1=Filtered, 2=Untagged	SVT= SVT? SVT* SVT#	SVT?	SVT=aaaabcde,aaaabcde,aaaabcde... (see Description of Arguments)
Add entry to VLAN table	SVA=	8 bytes	Command only. Adds entry to VLAN table in the form aaaabcde, where: aaaa=New VLAN ID: Value range=0001-4095, must not be duplicate of any PVID or VLAN ID existing in VLAN table. b=property of port 1: 0=Tagged, 1=Filtered, 2=Untagged c=property of port 2: 0=Tagged, 1=Filtered, 2=Untagged d=property of port 3: 0=Tagged, 1=Filtered, 2=Untagged e=property of port 4: 0=Tagged, 1=Filtered, 2=Untagged	SVA= SVA? SVA* SVA#	N/A	SVA=aaaabcde (see Description of Arguments)
Management VLAN ID	SMV=	4 bytes, numeric	Command or Query. Sets or returns the Management Port's VLAN ID in the form aaaa, where: aaaa=the VLAN ID number in the range 0001-4095.	SMV= SMV? SMV* SMV#	SMV?	SMV=aaaa (see Description of Arguments)
Delete entry in VLAN table	SVD=	4 bytes, numeric	Command only. Deletes VLAN table entry in the form aaaa, where: aaaa=the VLAN ID number in the range 0001-4095.	SVD= SVD? SVD* SVD#	N/A	SVD=aaaa (see Description of Arguments)

Parameter	Command (Instruction & Qualifier)	Number of Arguments	Description of Arguments	Response to Command	Query (Instruction & Qualifier)	Response to Query
Packet Processor Card Enable	PPE=	1 byte, 0 or 1	Command or Query. Sets or returns Packet Processor Card operation in the form x, where: 0=Packet Processor Card is Disabled 1=Packet Processor Card is Enabled NOTE: Change of this configuration results in modem auto-reboot <i>only</i> when IP Packet Processor option card is installed and enabled. Otherwise, when the IP Packet Processor option card is not installed, this selection is stored but is otherwise non-functional.	PPE= PPE? PPE* PPE#	PPE?	PPE=x (see Description of Arguments)
QoS Mode	QOS=	2 bytes, each 0 thru 3	Command or Query. Sets or returns QoS (Quality of Service) Mode in the form ab, where: a=Layer 2 QoS: 0=Off, Layer 2 QoS is disabled 1=VLAN Priority only 2=Port Priority only 3=VLAN and Port Priority b =Layer 3 QoS: 0=Off, Layer 3 QoS is disabled 1=Advanced QoS Max / Priority (requires Advanced QoS FAST Option)* 2=Advanced QoS Min Max (requires Advanced QoS FAST Option)* 3=Advanced QoS DiffServ (requires Advanced QoS FAST Option)* *NOTE: Layer 3 QoS settings 1 through 3 apply to modem <i>only</i> with IP Packet Processor option card installed and enabled.	QOS= QOS? QOS* QOS#	QOS?	QOS=ab (see Description of Arguments)
Switch Ports Configuration	SPC=	47 bytes	Command or Query. Sets or returns Ethernet switch ports' priority and PVID in the form 1abccccdxxx;2abccccdxxx;3abccccdxxx;4abccccdxxx, where: 1, 2, 3, or 4=Port number. a=Port priority: Value=1, 2, 3 or 4 (the higher the number, the higher the priority). b=Port Native Mode: 0=Native Mode Disabled, 1=Native Mode Enabled. cccc=Port VLAN ID: Value range=0000-4095 – Value 0000 is only valid when port Native Mode is disabled. d=Pause flow control. 0=Off, 1=On xxx=Reserved.	SPC= SPC? SPC* SPC#	SPC?	SPC=1abccccdxxx;2abccccdxxx;3abccccdxxx;4abccccdxxx (see Description of Arguments)
Edit entry in VLAN table	SVE=	8 bytes	Command only. Edit VLAN table entry in the form aaaabcde, where: aaaa=existing VLAN ID – Value range is 0001-4095. b=property of port 1: 0=Tagged, 1=Filtered, 2=Untagged c=property of port 2: 0=Tagged, 1=Filtered, 2=Untagged d=property of port 3: 0=Tagged, 1=Filtered, 2=Untagged e=property of port 4: 0=Tagged, 1=Filtered, 2=Untagged	SVE= SVE? SVE* SVE#	N/A	SVE=aaaabcde (see Description of Arguments)
Packet Processor Working Mode	WMD=	1 byte, 0 thru 3	Command or Query. Sets or returns Packet Processor Working Mode in the form x, where: 0=Managed Switch 1=Router Point to Point* 2=Router Multipoint Hub* 3=Router Multipoint Remote* *NOTE: Settings 1 through 3 apply to modem <i>only</i> with IP Packet Processor option card installed and enabled.	WMD= WMD? WMD* WMD#	WMD?	WMD=x (see Description of Arguments)

Parameter	Command (Instruction & Qualifier)	Number of Arguments	Description of Arguments	Response to Command	Query (Instruction & Qualifier)	Response to Query
Dedicated Management Port	DMP=	1 byte, 0 thru 8	Command or Query. Sets or returns Dedicated Ethernet Management port in Redundancy system in the form x, where: 0=Disabled (Any Ethernet port can do management, default value) 1=Port 1 2=Port 2 3=Port 3 4=Port 4 5=Port 1 – Local only* 6=Port 2 – Local only* 7=Port 3 – Local only* 8=Port 4 – Local only* NOTES: 1) VLAN must be Disabled to be able to select a port as Dedicated Management Port. 2) * Only LAN devices can access M&C of modem. NO remote modem access.	DMP= DMP? DMP* DMP#	DMP?	DMP=x (see Description of Arguments)
Ethernet 2048 Frame Size	EFS=	1 byte, 0 or 1	Command or Query. Sets or returns 2048-byte Ethernet Frame Size function in the form x, where: 0=2048 Ethernet Frame Size is Disabled 1=2048 Ethernet Frame Size is Enabled (supported by modem with baseboard hardware Rev2 and above)	EFS= EFS? EFS* EFS#	EFS?	EFS=x (see Description of Arguments)
Host Access List Enable/Disable	ACL=	1 byte, 0 or 1	Command or Query. Sets or returns IP Host Access List function in the form x, where: 0=Host Access List is Disabled 1=Host Access List is Enabled	ACL= ACL? ACL* ACL#	ACL?	ACL=x (see Description of Arguments)
Packet Processor Redundancy	PRD=	1 byte, 0 or 1	Command or Query. Valid only when Packet Processor is installed and Enabled. Sets or returns Packet Processor Redundancy function in the form x, where: 0=Disable Packet Processor Redundancy 1=Enable Packet Processor Redundancy	PRD= PRD? PRD* PRD#	PRD?	PRD=x (see Description of Arguments)
Precision Time Protocol	PTP=	1 byte, 0 or 1	Command or Query. Sets or returns Precision Time Protocol Feature function in the form x, where: 0=PTP is Disabled 1=PTP Enabled	PTP= PTP? PTP* PTP#	PTP?	PTP=x (see Description of Arguments)
Precision Time Protocol Grandmaster	PTM=	1 byte, 0 or 1	Command or Query. Sets or returns Precision Time Protocol Grandmaster function in the form x, where: 0=Grandmaster reachable over LAN. 1=Grandmaster reachable over WAN.	PTM= PTM? PTM* PTM#	PTM?	PTM=x (see Description of Arguments)
Packet Processor Bootrom FW Version	N/A	None	Query only. Valid only when Packet Processor is installed and Enabled. Returns Packet Processor Bootrom firmware version.	N/A	VS0?	VS0=x x is variable length of text
Packet Processor Image1 FW Version	N/A	None	Query only. Valid only when Packet Processor is installed and Enabled. Returns Packet Processor Image 1 firmware version.	N/A	VS1?	VS1=x x is variable length of text

Parameter	Command (Instruction & Qualifier)	Number of Arguments	Description of Arguments	Response to Command	Query (Instruction & Qualifier)	Response to Query
Packet Processor Image2 FW Version	N/A	None	Query only. Valid only when Packet Processor is installed and Enabled. Returns Packet Processor Image 2 firmware version.	N/A	VS2?	VS2=x x is variable length of text
Packet Processor Running FW Image	N/A	None	Query only. Valid only when Packet Processor is installed and Enabled. Returns Packet Processor Running firmware image.	N/A	AFI?	AFI=x x is variable length of text

Chapter 9. TELNET COMMAND LINE INTERFACE (CLI) OPERATION

9.1 Overview

The Telnet Command Line Interface (referred to hereafter as the Telnet CLI or the CLI) is an Ethernet-based user menu system for the CDM-625A Advanced Satellite Modem equipped with an **installed and enabled** optional IP Packet Processor card. The CLI allows configuration, monitoring and control of the unit using a user-supplied terminal emulator (e.g., PuTTY or Tera Term).

9.1.1 Interface Access



Any changes made to the modem that are not saved to permanent storage during the active session will be lost if the modem is reset or loses power. This applies to all of the base modem and optional Packet Processor parameters. The parameters can be saved by pressing [F8] on any Telnet CLI configuration page.

For connection via a Terminal Emulator: The user PC must have network connectivity to a Traffic Ethernet Port of the IP Module. This connectivity can be via a local LAN, a remote LAN, or via a satellite link from another IP modem.

9.1.2 Terminal Emulator Considerations



- 1) For best results, Comtech EF Data recommends PuTTY or Tera Term as the preferred terminal emulators.
- 2) Use of the HyperTerminal terminal emulator is not supported or recommended.
- 3) The numeric keypad's ENTER key may not work on some terminal emulators.

9.1.2.1 Using the PuTTY Terminal Emulator

First, you must define your Telnet session connection:



- For **Connection type**, select **Telnet**;
- For **Host Name (or IP Address)**, enter the interface IP Address (e.g., 192.168.1.11);
- For **Port**, enter **107**;
- Click **[Open]** to proceed.

Next, log in to the Telnet CLI using a valid **Username** and **Password**:

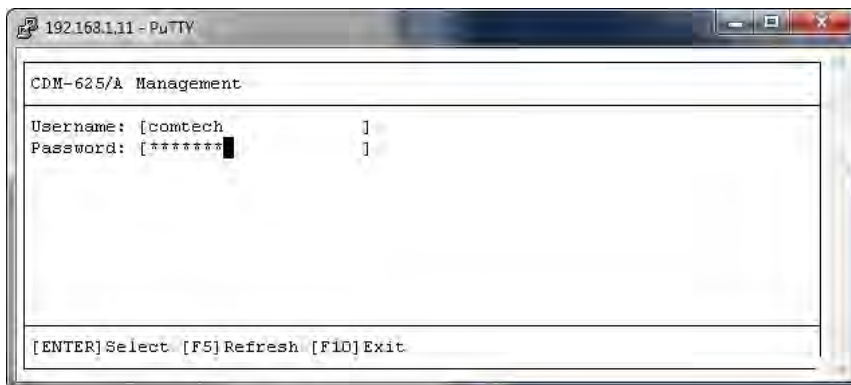

The Telnet CLI Home menu should now be accessible:

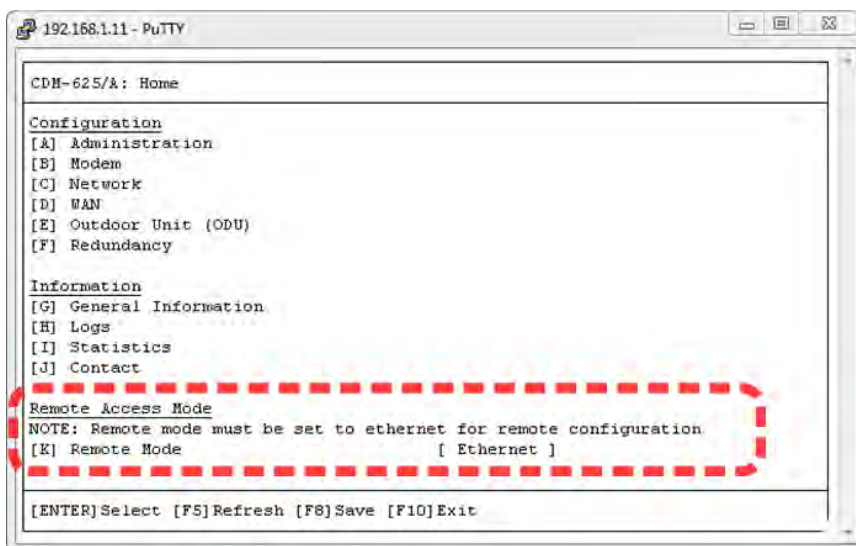

1) In order to use the Telnet CLI to make configuration changes to the CDM-625A, Remote Access Mode should always be set to [Ethernet].

2) PuTTY in Linux may require the following setting to render correctly:

Settings > Window > Translation > Override with UTF-8 if locale says so [UNCHECK]

9.1.2.2 Using the Tera Term Terminal Emulator

First, you must define your Telnet session connection:



- Select **TCP/IP**;
- For **Host**, enter the interface IP Address (e.g., 192.168.1.11);
- For **Service**, select **Telnet**;
- For **TCP port #**, enter **107**;
- Click **[OK]** to proceed.

Next, before you log in, Tera Term requires the following settings on the **Setup > Terminal** page:

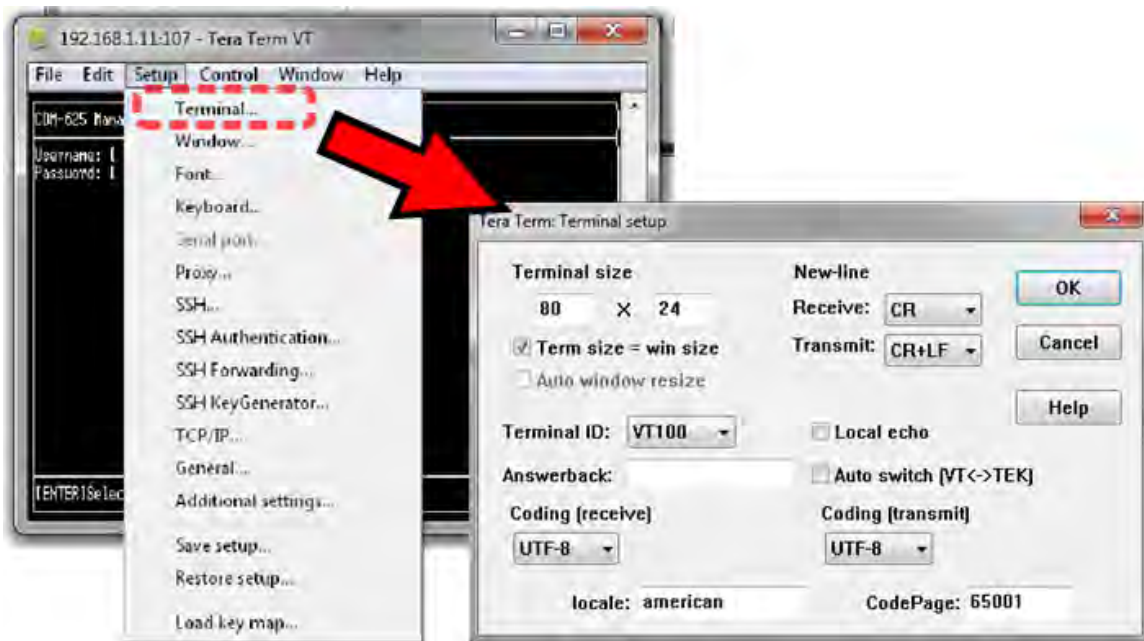

- For **New-Line[Receive]**, use the drop-down list to select **CR**;
- For **New-Line[Transmit]**, use the drop-down list to select **CR+LF**.

Finally, log in to the Telnet CLI using a valid **Username** and **Password**:

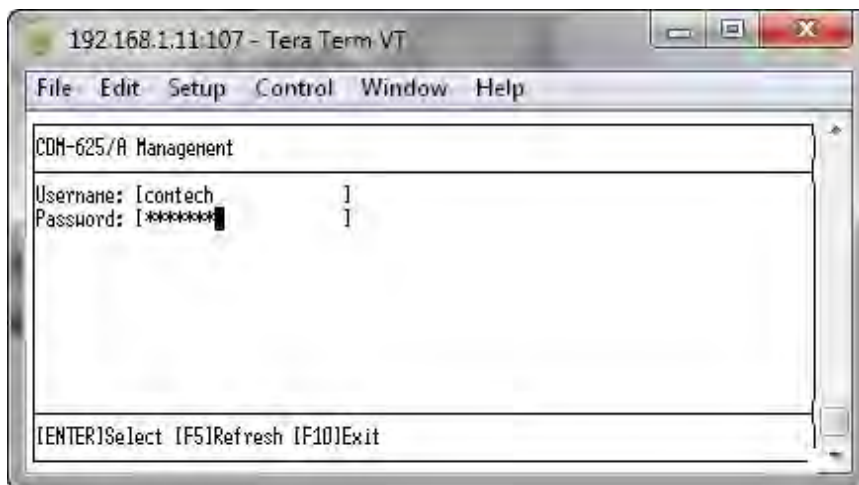

The Telnet CLI Home menu should now be accessible:

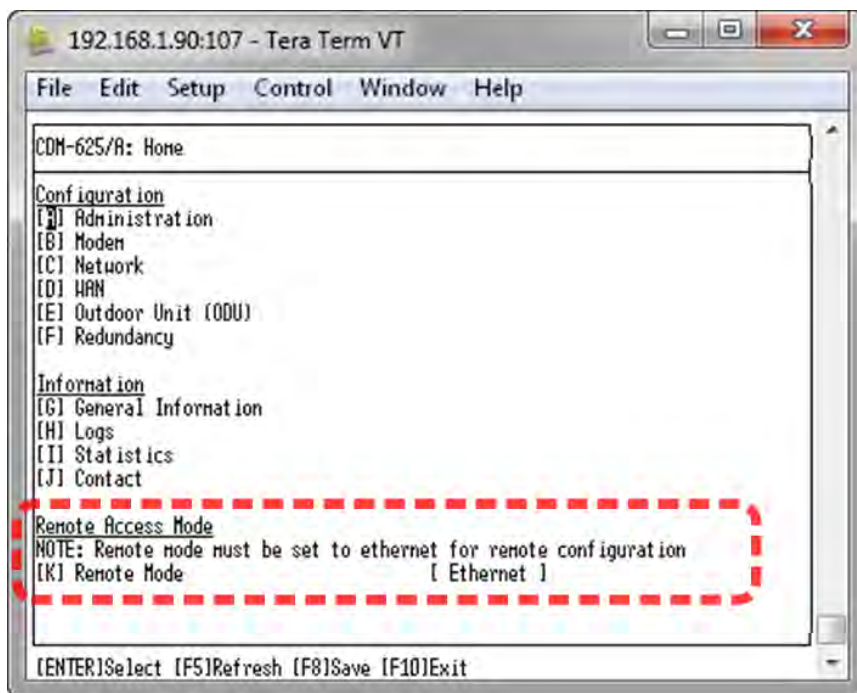

In order to use the Telnet CLI to make configuration changes to the CDM-625A, Remote Access Mode should always be set to [Ethernet].

9.2 Using the Telnet Command Line Interface (CLI)



In order to use the Telnet CLI to make configuration changes to the CDM-625A, Remote Access Mode should always be set to [Ethernet].

9.2.1 Telnet CLI Menu System – Parallel Functionality

The Telnet CLI allows monitoring, configuration, and control of the CDM-625A Satellite Modem in a manner similar to functionality provided via its front panel menus and the CDM-625A Web Server Interface. See those chapters for more in-depth explanations of operation.



- Chapter 6. FRONT PANEL OPERATION
- Chapter 7. ETHERNET-BASED REMOTE PRODUCT MANAGEMENT



Certain configuration menu selections (e.g., Carrier-in-Carrier) are functional only when that FAST feature has been purchased and enabled for operation. This chapter documents the CLI as if all available options are installed – your configuration may or may not provide the level of functionality as described in this chapter.

9.2.2 CLI Menus – Common Navigation and Operation Features

- 1) The CLI organizes operation under a hierarchy of Configuration and Information functions. You may select a configuration submenu or information page (e.g., Administration, Statistics, etc.) from this top-level menu, either by typing in the bracketed hot key that precedes the submenu name, or by using the **↑↓** arrow keys and pressing **ENTER**. Each submenu provides nested dialog windows requiring further action.
- 2) The bottom of each “screen” shows the possible actions to take.

Home (Main) Menu page:

```
[ENTER]Select [F5]Refresh [F10]Exit
```

Submenu or nested pages (e.g., Administration, Statistics, etc.):

```
[ENTER]Select [ESC]Back [F5]Refresh [F10]Exit
```

Dialog windows:

```
[ENTER]Select [ESC]Back [F5]Refresh [F8]Save [F10]Exit
```

Table pages:

```
[ENTER]Select [ESC]Back [F5]Refresh [F8]Save [F9]Add [F11]Delete [F10]Exit
```

Note the following:

Selection	Description
[ENTER]Select	Press [ENTER] to accept any updates or changes made on this page – this does not save the selection to configuration memory, additional action is required.
[ESC] Back	Press [ESC] to exit the current menu and return to the parent submenu.
[F5] Refresh	Press [F5] to discard any changes made on the page and restore all values from the modem
[F8] Save	Press [F8] to save the currently defined settings to configuration memory
[F9] Add	Press [F9] to add a new index to a table (e.g., VLAN Table, Sect. 9.3.4.4.1)
[F10] Exit	Press [F10] to end the CLI session and close the terminal emulator window
[F11] Delete	Press [F11] to delete an existing index from a table (e.g., VLAN Table, Sect.9.3.4.4.1)

- 3) Any menu selection that requires user input typically features an input dialog window. Once a menu option is selected, its dialog window opens and you must use the **↑↓** arrow keys to select a functional choice:

```

Tx Interface Type
RS-422
V35
G.703 balanced
G.703 unbalanced
Audio
LVDS
HSSI
IP
[ENTER] Accept [ESC] Back [UP/DOWN] Select
    
```

Other dialog windows require entry of a descriptive alphanumeric string or an operational numeric value. This example of the **Home > Administration > SNMP: [A] Contact** dialog window shows “Remote A Site” as the **Current Value** and prompts you to enter an alphanumeric **New Value**:

```

Contact
Current Value : Remote A Site
New Value : 
[ENTER] Accept [ESC] Back [UP/DOWN] Select
    
```

Type the new parameter, and then press [ENTER] to accept the entry. The dialog window closes and the CLI returns you to the active configuration page.

- 4) Each dialog windows provides cues to ensure proper configuration of the unit. If you enter an invalid parameter, the CLI rejects the entry and displays an error message at the bottom of the window, as shown in this example:

```

Access Network Prefix
Range 1 : 0 - 0
Range 2 : 8 - 32
Current Value : 0
New Value : 6
Number is out of range.
[ENTER] Accept [ESC] Back [UP/DOWN] Select
    
```

Here, the CLI rejects the attempted entry of **6** and displays the message “Number is out of range”. Re-enter a new value (in this example, a value within the acceptable ranges of **0** and **8-32**) and then press [ENTER] to continue. Otherwise, press [ESC] to quit the dialog window and return to the configuration page. You may then proceed with further configuration updates.

- 5) Any menu item that has been changed since the previous save gets appended with an asterisk [*], as “CnC Mode” shows in this example:

```

CDM-625/A: Home > Modem > CnC
[A] CnC Mode [ Off ] *
[B] CnC Search Min Delay [ 10 ] * second
[C] CnC Search Max Delay [ 290 ] millisecond
[D] CnC Frequency Offset [ 30 ] KHz
[E] CnC PMSI Mode [ Idle ]

[ENTER]Select [ESC]Back [F5]Refresh [F8]Save [F10]Exit
    
```



You must press [F8] to save any changes to the modem memory. If you press [ESC] after changes have been made – but not saved – on a page, the Unsaved Changes window opens to force further action:

```

Unsaved Changes
-----
Save changes?

[ Save ]          Discard          Go Back
    
```

Use the ← → arrow keys to select an action:

Selection	Action
[Save]	Save any changes made to the page to memory
[Discard]	Exit the page without saving and return to the parent submenu
[Go Back]	Return to the active configuration window to review or make further changes

- 6) For any page where the content exceeds the defined window height, a scroll bar appears on the right hand side of the page:

```

CDM-625/A: Home > Administration > FAST Options
Model Number          625A
Demo Mode
[A] Demo Mode         [ Disabled ]
Demo Time              30 days 0 hours 0 minutes

NOTE: Reboot modem after enabling/disabling demo mode
NOTE: FAST codes cannot be configured with this interface

Data Rate Options
Data Rate Option      Up To 25 Mbps
TPC Data Rate Option  Up To 25 Mbps
LDPC Data Rate Option Up To 25 Mbps
CnC Data Rate Option  Up To 25 Mbps
VersaFEC Data Rate Option Up To 16 Mbps
ACM Symbol Rate Option Up To 4100 kbps
Payload Compression Option Up To 25 Mbps

[ENTER]Select [ESC]Back [F5]Refresh [F8]Save [F10]Exit
    
```

Use the ↑↓ arrow keys within the window to scroll through the page contents.



This chapter documents the entire Telnet Command Line Interface. Some features may not be available with your modem as equipped. Your CLI window appearances may differ based on your terminal emulator’s configured window settings.

9.3 Command Line Interface Pages

9.3.1 Home (Main) Menu

```

CDM-625/A: Home

Configuration
[A] Administration
[B] Modem
[C] Network
[D] WAN
[E] Outdoor Unit (ODU)
[F] Redundancy

Information
[G] General Information
[H] Logs
[I] Statistics
[J] Contact

Remote Access Mode
NOTE: Remote mode must be set to ethernet for remote configuration
[K] Remote Mode           [ Ethernet ]

[ENTER]Select [F5]Refresh [F8]Save [F10]Exit
    
```

The **Home Menu** serves as the CLI's primary navigation page. All selections made on this page take you to the submenus listed in this table. Press a hot key to access a submenu from this top-level navigation page.

Hot Key	Description	Function	Sect.
A	Administration	Access administrative configuration submenu	9.3.2
B	Modem	Access modem configuration submenu	9.3.3
C	Network	Access network configuration submenu	9.3.4
D	WAN	Access WAN configuration submenu	9.3.5
E	Outdoor Unit (ODU)	Access ODU comms, CSAT-5060 configuration submenus (summary only)	9.3.6
F	Redundancy	Access 1:1 or 1:N redundancy configuration submenu	9.3.7
G	General Information	Enter alphanumeric Circuit ID; view read-only CDM-625A operations information screens	9.3.8
H	Logs	Access Base Modem and Packet Processor stored events and statistics logs, alarms control submenus	9.3.9
I	Statistics	Access CDM-625A operational statistics submenus	9.3.10
J	Contact	View read-only Customer Support contact information screen	9.3.11
K	Remote Mode	Open the Remote Access Mode setting	9.3.1.1

See the listed chapter section for further information. Once you have confirmed that the Telnet CLI's Remote Access Mode is set to **[Ethernet]**, press a hot key to access a configuration submenu.

9.3.1.1 Home > Remote Access Mode

In order to proceed with the operations described through the remaining chapter, you must be sure to set Remote Access Mode to **[Ethernet]** in order for configuration changes to be saved into memory.

First, from the Home menu, press **[K]** to open the Remote Access Mode dialog window:

```

CDM-625/A: Home

===Configuration===
[A] Administration
[B] Modem
[C] Netwo
[D] WAN
[E] Out D
[F] Redun
[G] Gener
[H] Logs
[I] Stati
[J] Conta

Remote Mode
Local
Serial
EDMAC Slave
Ethernet





===Inform
[G] Gener
[H] Logs
[I] Stati
[J] Conta

===Remote
[ENTER] Accept [ESC] Back [UP/DOWN] Select

NOTE: Rem
[K] Remote Mode          [ Ethernet ]

[ENTER] Select [F5] Refresh [F10] Exit
    
```

Then, use the **↑↓** arrow keys to select the Remote Mode as **Ethernet**, and press **[ENTER]** to accept the selection. Finally, press **[F8]** to save to memory. Note the following:

Remote Access Mode Selection	Function
Local	Configuration using Front Panel only  Chapter 6. FRONT PANEL OPERATION
Serial	Configuration using Serial Port  • Sect. 6.2.1.12 CONFIG: REMOTE (Remote Control) • Chapter 8. SERIAL-BASED REMOTE PRODUCT MANAGEMENT
EDMAC Slave	 EDMAC mode cannot be set here – the CLI displays “EDMAC Slave” when the modem is in EDMAC Slave Mode  Appendix H. EDMAC CHANNEL
Ethernet	Configuration using SNMP / Telnet CLI / Web Server Interface  Chapter 7. ETHERNET-BASED REMOTE PRODUCT MANAGEMENT

9.3.2 Home > Administration Submenu

```

CDM-625/A: Home > Administration

[A] Host Access List
[B] SNMP
[C] Firmware (Base Modem)
[D] Firmware (Packet Processor)
[E] Reboot
[F] FAST Options
[G] Save Modem Configuration
[H] Load Modem Configuration
[I] Restore Factory Defaults

[ENTER] Select [ESC] Back [F5] Refresh [F10] Exit
    
```

Open the Administration submenu from the Home menu. This submenu contains the following options:

Hot Key	Configuration Page	Function	Sect.
A	Host Access List	Configure Host Access List(s)	9.3.2.1
B	SNMP	Configure SNMP parameters and traps	9.3.2.2
C	Firmware (Base Modem)	View Base Modem firmware information or select image load	9.3.2.3
D	Firmware (Packet Processor)	View Packet Processor firmware information or select image load	
E	Reboot	Reboot the CDM-625A	9.3.2.4
F	FAST Options	Set the FAST Feature Demo Mode or view currently installed FAST options	9.3.2.5
G	Save Modem Configuration	Save up to 10 modem configurations to memory	9.3.2.6
H	Load Modem Configuration	Recall 1 of 10 modem configurations from memory	
I	Restore Factory Defaults	Discard any configuration changes and restore all settings "as shipped"	9.3.2.7

Press a hot key to access a configuration page. See the specified chapter section for further configuration information. Otherwise, press **[ESC]** to return to the Home menu.

9.3.2.1 Home > Administration > Host Access List

```

CDM-625/A: Home > Administration > Host Access List

[A] Access List Enforcement          [ Disabled ]

Access IP 1
[B] Access List Entry Enable        [ Disabled ]
[C] Access IP Address               [ 0.0.0.0 ]
[D] Access Network Prefix           [ 0 ]



Access IP 2
[E] Access List Entry Enable        [ Disabled ]
[F] Access IP Address               [ 0.0.0.0 ]
[G] Access Network Prefix           [ 0 ]

Access IP 3
[H] Access List Entry Enable        [ Disabled ]
[I] Access IP Address               [ 0.0.0.0 ]
[J] Access Network Prefix           [ 0 ]

Access IP 4
[K] Access List Entry Enable        [ Disabled ]
[L] Access IP Address               [ 0.0.0.0 ]
[M] Access Network Prefix           [ 0 ]

[ENTER]Select [ESC]Back [F5]Refresh [F8]Save [F10]Exit
    
```

Open the scrollable Host Access List page from the Administration submenu. This page contains the following options:

Hot Key	Dialog Window	Function / Option Entry
A	Access List Enforcement	Use ↑↓ arrow keys to select Enabled or Disabled
B	Access IP 1 Access IP List Entry Enable	Typical for each entry – Use ↑↓ arrow keys to set each list as Enabled or Disabled
E	Access IP 2 Access IP List Entry Enable	
H	Access IP 3 Access IP List Entry Enable	
K	Access IP 4 Access IP List Entry Enable	
C	Access IP 1 Access IP Address	Typical for each entry – Enter each IP Address in the form XXX.XXX.XXX.XXX  Be sure to include your system's IP Address in this list
F	Access IP 2 Access IP Address	
I	Access IP 3 Access IP Address	
L	Access IP 4 Access IP Address	
D	Access IP 1 Access Network Prefix	Typical for each entry – Enter a value as follows: <ul style="list-style-type: none"> • Range 1 – Enter a value of 0 • Range 2 – Enter a value from 8 to 32  If you enter an invalid value, the CLI displays error message "Number is out of range"
G	Access IP 2 Access Network Prefix	
J	Access IP 3 Access Network Prefix	
M	Access IP 4 Access Network Prefix	

Press a hot key to open a dialog window. Otherwise, press **[ESC]** to return to the Administration submenu.

9.3.2.2 Home > Administration > SNMP

```

CDM-625/A: Home > Administration > SNMP

SNMP Parameters
[A] Contact                [ Remote A Site ]
[B] Name                   [ Technician A ]
[C] Location               [ USA ]

SNMP Traps
[D] Enable Authentication Traps [ Enabled ]
[E] SNMP Trap Destination IP Address1 [ 0.0.0.0 ]
[F] SNMP Trap Destination IP Address2 [ 0.0.0.0 ]
[G] SNMP Trap Version       [ SNMP V1 ]
[H] SNMP Trap Community     [ comtech ]

[ENTER] Select [ESC] Back [F5] Refresh [F8] Save [F10] Exit
    
```

Open the SNMP page from the Administration submenu. This page contains the following options:

Hot Key	Dialog Window	Option Entry
A	Contact	Typical for each entry – Enter the desired designations
B	Name	
C	Location	
D	Enable Authentication Traps	Use the ↑↓ arrow keys to select Enabled or Disabled
E	SNMP Trap Destination IP Address 1	Typical for either entry – Enter either IP Address in the form XXX.XXX.XXX.XXX
F	SNMP Trap Destination IP Address 2	
G	SNMP Trap Version	Use the ↑↓ arrow keys to select SNMP V1 or SNMP V2
H	SNMP Trap Community	Enter the desired Trap Community name – the default name is comtech

Press a hot key to open a dialog window. Otherwise, press **[ESC]** to return to the Administration submenu.

9.3.2.3 Home > Administration > Firmware (Base Modem) or (Packet Processor)

```

CDM-625/A: Home > Administration > Firmware (Base Modem)

[A] Boot From                [ Image1 ]

Software Revision            1.1.1
Bootrom                     FW/12865C,1.2.0,07/08/13
Firmware Image1             FW-0020731-,1.1.1,02/10/13
Firmware Image2             FW-0020731-,1.1.1,24/09/13
Running Image                Image1

[ENTER]Select [ESC]Back [F5]Refresh [F8]Save [F10]Exit
    
```

```

CDM-625/A: Home > Administration > Firmware (Packet Processor)

[A] Boot From                [ Image2 ]

Bootrom Info
FW-0000346J, 1.4.2, 08/14/13 11:24:04
Image1 Info
FW-0000438G, 1.4.1, 07/16/13 16:00:04
Image2 Info
FW-0000438H, 1.4.2, 08/14/13 11:24:04
Running Image                Image2

[ENTER]Select [ESC]Back [F5]Refresh [F8]Save [F10]Exit
    
```

Open the Base Modem and Packet Processor Firmware pages from the Administration submenu. Use these pages to view the current firmware information, or to select the alternate firmware image to be loaded at startup or reboot. Both pages contain the following option:

Hot Key	Dialog Window	Option Entry
A	Boot From	Use the ↑↓ arrow keys to set load as Image1 or Image2

Press the hot key to open the dialog window. Otherwise, press **[ESC]** to return to the Administration submenu.



You must reboot the unit in order for the new firmware image load selection to take effect.

9.3.2.4 Home > Administration > Reboot

```
CDM-625/A: Home > Administration > Reboot
[A] Force Reboot [ No ]
Force Reboot
No
Yes
[ENTER] Accept [ESC] Back [UP/DOWN] Select
[ENTER] Select [ESC] Back [F5] Refresh [F8] Save [F10] Exit
```

Open the Reboot page from the Administration submenu. Use this page to perform a soft reboot of the CDM-625A. Otherwise, press **[ESC]** to return to the Administration submenu.

Hot Key	Dialog Window	Option Entry
A	Force Reboot	Use the ↑↓ arrow keys to select No (default) or Yes to reboot



You must restart your Telnet CLI session upon reboot of the CDM-625A.

9.3.2.5 Home > Administration > FAST



- Chapter 5. FAST ACTIVATION PROCEDURE
- Sect. 6.2.8 SELECT: FAST Menus in Chapter 6. FRONT PANEL OPERATION

```

CDM-625/A: Home > Administration > FAST Options

Model Number                625A

Demo Mode
[A] Demo Mode                [ Disabled ]
Demo Time                    30 days 0 hours 0 minutes

NOTE: Reboot modem after enabling/disabling demo mode

NOTE: FAST codes cannot be configured with this interface



Data Rate Options
Data Rate Option            Up To 25 Mbps
TPC Data Rate Option        Up To 25 Mbps
LDPC Data Rate Option       Up To 25 Mbps
CnC Data Rate Option        Up To 25 Mbps
VersaFEC Data Rate Option   Up To 16 Mbps
ACM Symbol Rate Option      Up To 4100 kbps
Payload Compression Option  Up To 25 Mbps
Header Compression Option   Up To 25 Mbps

Other Options
Packet Processor Card       Installed
External 20 dB Attenuator   Not Installed
L-Band Option              Installed
Open Network Framing Option Installed
8ARY Option                Installed
16ARY Option               Installed
AES Option                 Installed
Advanced QoS Option         Installed
QDI Option                 Installed
TPC/LDPC Codec             Not Installed
G.703 Clock Extension Option Installed
Fractional CnC Option      Not Installed
Advanced Network Timing Option Installed
Carrier ID Option          Installed
DNI Option                 Installed
Audio Chips                Installed

[ENTER] Select [ESC] Back [F5] Refresh [F8] Save [F10] Exit

```

Open the FAST Options page from the Administration submenu. Use this page to review your unit's available and installed FAST features.

Hot Key	Dialog Window	Option Entry
A	Demo Mode	<p>Use the ↑↓ arrow keys to set Demo Mode as Disabled (default) or Enabled</p> <p> 1) If Enabled, the CDM-625A begins operation in FAST Demo Mode – FAST Options Demo Mode allows access to ALL CDM-625A FAST options for 30 calendar days</p> <p>2) You must reboot the modem after enabling or disabling Demo Mode</p> <p> Sect. 6.2.8.2. FAST: Demo Mode (Chapter 6. FRONT PANEL OPERATION)</p>

Press **[A]** to open the Demo Mode dialog window. Otherwise, press **[ESC]** to return to the Administration submenu.

9.3.2.6 Home > Administration > Save Modem Configuration / Load Modem Configuration

```
CDM-625/A: Home > Administration > Save Modem Configuration

[A] Save to Slot          [ ]
Configuration Slot0      13:04:32 25/06/13
Configuration Slot1      Available
Configuration Slot2      Available
Configuration Slot3      Available
Configuration Slot4      Available
Configuration Slot5      Available
Configuration Slot6      Available
Configuration Slot7      Available
Configuration Slot8      Available
Configuration Slot9      Available

[ENTER]Select [ESC]Back [F5]Refresh [F8]Save [F10]Exit
```

```
CDM-625/A: Home > Administration > Load Modem Configuration

[A] Load from Slot       [ ]
Configuration Slot0      13:04:32 25/06/13
Configuration Slot1      Available
Configuration Slot2      Available
Configuration Slot3      Available
Configuration Slot4      Available
Configuration Slot5      Available
Configuration Slot6      Available
Configuration Slot7      Available
Configuration Slot8      Available
Configuration Slot9      Available

[ENTER]Select [ESC]Back [F5]Refresh [F8]Save [F10]Exit
```

Open the Save Modem Configuration and Load Modem Configuration pages from the Administration submenu. Use these pages to save and load up to 10 modem configurations.

Press **[A]** to open the Save to Slot or Load from Slot dialog window. Otherwise, press **[ESC]** to return to the Administration submenu.

Each modem configuration is stored in an assigned “slot” – 0 through 9. If a configuration slot is available for storage, either page notes the status of that slot as **Available**. Otherwise, if the slot contains an existing configuration, that slot’s storage time is specified in military format (HH:MM:SS); the date is shown in **DAY-MONTH-YEAR** format in accordance with European convention.

To store (save) a configuration setting:

- First, make any desired configuration changes to the modem.

- Next, open the Save Modem Configuration window (**Home > [A] Administration > [G] Save Modem Configuration**). Note the Configuration slots listed in the window, and then press **[A] Save to Slot**. The nested dialog window opens:

Save to Slot	
Min	: 0
Max	: 9
Current Value	:
New Value	: █
[ENTER] Accept [ESC] Back [UP/DOWN] Select	

- Then, enter 0 through 9, and then press **[ENTER]** to accept the selection.
- Finally, press **[F8]** to save (store) the configuration. Wait while the configuration is stored into memory.

Once a modem configuration is stored into the designated slot, the time and date are recorded, and this information appears on the configuration slot line.

To load (recall) a configuration setting:

- First, open the Load Modem Configuration window (**Home > [A] Administration > [H] Load Modem Configuration**). Note the saved configuration slots listed in the window, and then press **[A] Load from Slot**. The nested dialog window opens:

Load from Slot	
Min	: 0
Max	: 9
Current Value	:
New Value	: █
[ENTER] Accept [ESC] Back [UP/DOWN] Select	

- Then, enter 0 through 9, and press **[ENTER]** to accept the selection.
- Finally, press **[F8]** to load (recall) the configuration. Wait while the configuration is loaded from memory.

9.3.2.7 Home > Administration > Restore Factory Defaults

```

CDM-625/A: Home > Administration > Restore Factory Defaults

CAUTION: This will restore factory defaults
[A] Restore Factory Defaults          [ Cancel ]

  Restore Factory Defaults
  Cancel
  Restore

  [ENTER] Accept [ESC] Back [UP/DOWN] Select

[ENTER] Select [ESC] Back [F5] Refresh [F10] Exit
    
```

Open the Restore Factory Default page from the Administration submenu. Use this page to restore the CDM-625A settings to the original settings as shipped from the factory.

Hot Key	Dialog Window	Option Entry
A	Restore Factory Defaults	Use the ↑↓ arrow keys to set as Cancel (default) or Restore

Press **[A]** to open the Restore Factory Defaults dialog window. Otherwise, press **[ESC]** to return to the Administration submenu.

By selecting **Restore**, the unit proceeds with restoration of factory defaults. Wait while the unit reboots.



You must restart your Telnet CLI session upon reboot of the CDM-625A.

9.3.3 Home > Modem Submenu

```

CDM-625/A: Home > Modem

[A] Interface
[B] Modem TX
[C] Modem RX
[D] Carrier-in-Carrier (CnC)
[E] Adaptive Coding and Modulation (ACM)
[F] Drop and Insert (D&I)
[G] Block Upconverter (BUC)
[H] Low-Noise Block Downconverter (LNB)
[I] MEO
[J] Utilities
[K] Overhead

[ENTER]Select [ESC]Back [F5]Refresh [F10]Exit
    
```

Open the Modem submenu from the Home menu. This submenu contains the following options:

Hot Key	Configuration Page	Function	Sect.
A	Interface	Configure the Tx and Rx Framing Modes	9.3.3.1
B	Modem TX	Configure the unit's Tx parameters	9.3.3.2
C	Modem RX	Configure the unit's Rx parameters	9.3.3.3
D	Carrier-in-Carrier (CnC)	Configure CnC FAST Option	9.3.3.4
E	Adaptive Coding and Modulation (ACM)	Configure ACM FAST Option	9.3.3.5
F	Drop and Insert (D&I)	Configure D&I parameters	9.3.3.6
G	Block Upconverter (BUC)	Configure BUC parameters and view operating statistics	9.3.3.7
H	Low-Noise Block Downconverter (LNB)	Configure LNB parameters and view operating statistics	9.3.3.8
I	MEO (Medium Earth Orbit)	 MEO (Medium Earth Orbit) and its associated functions are not supported in FW Ver. 1.2.4. Its hot key and nested screen, while selectable and viewable, are NON-FUNCTIONAL at this time.	9.3.3.9
J	Utilities	Configure and monitor a variety of unit operational settings	9.3.3.10
K	Overhead	Configure ESC, IDR Backward Alarms, AUPC, and EDMAC	9.3.3.11

Press a hot key to access a configuration page. See the specified chapter section for further configuration options. Otherwise, press **[ESC]** to return to the Home menu.

9.3.3.1 Home > Modem > Interface

```

CDM-625/A: Home > Modem > Interface

[A] Tx Interface Type           [ RS-422 ]
[B] Tx Framing Mode             [ EDMAC ]
[C] Rx Interface Type           [ RS-422 ]
[D] Rx Framing Mode             [ EDMAC ]

[ENTER]Select [ESC]Back [F5]Refresh [F8]Save [F10]Exit
    
```

Open the Interface page from the Modem submenu. This page contains the following options:

Hot Key	Dialog Window	Option Entry
A	Tx Interface Type	Typical for either entry – Use the ↑↓ arrow keys to select: <ul style="list-style-type: none"> • RS-422 • V.35 • G.703 Balanced
C	Rx Interface Type	<ul style="list-style-type: none"> • G.703 Unbalanced • Audio • LVDS • HSSI • IP • ASI • IP ACM
B	Tx Framing Mode	Typical for either entry – Use the ↑↓ arrow keys to select: <ul style="list-style-type: none"> • Unframed • IBS • IDR
D	Rx Framing Mode	<ul style="list-style-type: none"> • DNI • EDMAC • DNI ++ • ESC ++ • EDMAC2 • QDI • Frm QDI • EDMAC3

Press a hot key to open a dialog window. Otherwise, press **[ESC]** to return to the Modem submenu.

9.3.3.2 Home > Modem > Modem TX

```

CDM-625/A: Home > Modem > Modem TX

[A] Tx FEC Type           [ TPC ]
[B] Tx Mod Type          [ 16QAM ]
[C] Tx FEC Code Rate     [ Rate 7/8 ]
[D] Tx Data Rate         [ 24000.000 ] Kbps
[E] Tx Symbol Rate       [ 7006.280 ] Ksps
[F] Tx Frequency         [ 79.0000 ] MHz
[G] Tx Spectrum Invert   [ Normal ]
[H] Tx Scrambler         [ IESS315 ]
[I] Tx Power Level       [ -25.0 ] dBm
[J] Tx Reed-Solomon Encoding [ Normal ]
[K] Tx Data Invert       [ Normal ]
[L] Tx Data Clock Invert [ Normal ]
[M] Tx Ternary Code      [ B8zs ]
[N] Tx Carrier State     [ On ]
[O] POCO                 [ Disabled ]
[P] Tx Submux            [ Off ]
[Q] Tx Submux Ratio      [ 1/9 ] IP/Synchronous
[R] Tx Filter Rolloff Factor [ Factor 0.35 ]

[ENTER] Select [ESC]Back [F5]Refresh [F8]Save [F10]Exit
    
```

Open the Modem TX page from the Modem submenu. This page contains the following options:

Hot Key	Dialog Window	Option Entry
A	Tx FEC Type	Use the ↑↓ arrow keys to select: <ul style="list-style-type: none"> • None Diff Enc On • Sequential • TCM Reed-Solomon • LDPC • VersaFEC-2 Long Block • Viterbi • Sequential Reed-Solomon • TPC • VersaFEC • VersaFEC-2 Short Block • Viterbi Reed-Solomon • TCM • None Diff Enc Off • ULL
B	Tx Mod Type	Use the ↑↓ arrow keys to select: <ul style="list-style-type: none"> • BPSK • 8PSK • 8-ARY (VFEC-2) • QPSK • 16QAM • 16-ARY (VFEC-2) • OQPSK • 8QAM • 32-ARY (VFEC-2)
C	Tx FEC Code Rate	Use the ↑↓ arrow keys to select the Tx FEC Code Rate.  See the table provided in Sect. 6.2.1.3.5 CONFIG: Tx→Mod (Chapter 6. FRONT PANEL OPERATION) for the list of available FEC Rate Choices.
D	Tx Data Rate	Enter a value from 18.000 to 25000.000 Kbps
E	Tx Symbol Rate	Enter a value from 18.000 to 25000.000 Ksps
F	Tx Frequency	Enter a value as follows: <ul style="list-style-type: none"> • Range 1 – From 50.0000 to 180.0000 MHz • Range 2 – From 950.0000 to 2250.0000 MHz
G	Tx Spectrum Invert	Use the ↑↓ arrow keys to select Normal or Inverted
H	Tx Scrambler	Use the ↑↓ arrow keys to select Off , Normal , or IESS315

Hot Key	Dialog Window	Option Entry
I	Tx Power Level	Enter a value as follows: <ul style="list-style-type: none"> • Range 1 – From -99.9 to 99.9 dBm • Range 2 – From -40.00 to 0.0 dBm
J	Tx Reed-Solomon Encoding	Use the ↑↓ arrow keys to select Normal , IESS410 , EF Data , or IBS
K	Tx Data Invert	Typical for either entry – Use the ↑↓ arrow keys to select Normal or Inverted
L	Tx Data Clock Invert	
M	Tx Ternary Code	Use the ↑↓ arrow keys to select AMI , B8zs , B6zs , or Hdb3
N	Tx Carrier State	Use the ↑↓ arrow keys to select: <ul style="list-style-type: none"> • Off • Off External • RTI, 2 s timeout • On • Off BUC delay • RTI, 4 s timeout • RTI, 10 s timeout • RTI, 1 s timeout • RTI, 7 s timeout
O	POCO	Use the ↑↓ arrow keys to select Disabled or Enabled
P	Tx Submux	Use the ↑↓ arrow keys to select Off or On
Q	Tx Submux Ratio	Use the ↑↓ arrow keys to select an IP/Synchronous setting: <ul style="list-style-type: none"> • 1/9 • 2/7 • 2/3 • 3/2 • 7/2 • 9/1 • 1/8 • 1/3 • 3/4 • 5/3 • 4/1 • 1/59 • 1/7 • 2/5 • 4/5 • 2/1 • 5/1 • 1/39 • 1/6 • 3/7 • 1/1 • 7/3 • 6/1 • 1/19 • 1/5 • 1/2 • 5/4 • 5/2 • 7/1 • 1/4 • 3/5 • 4/3 • 3/1 • 8/1
R	Tx Filter Rolloff Factor	Use the ↑↓ arrow keys to select a Tx Rolloff Factor: <ul style="list-style-type: none"> • 0.05 • 0.20 • 0.10 • 0.25 • 0.15 • 0.30



Valid code rates depend on the selected FEC and Mod types – for example, you cannot select “VersaFEC 16QAM 0.644” if your FEC is “TCM”

Press a hot key to open a dialog window. Otherwise, press **[ESC]** to return to the Modem submenu.

9.3.3.3 Home > Modem > Modem RX



```

CDM-625/A: Home > Modem > Modem RX

[A] Rx FEC Type                [ Viterbi ]
[B] Rx Demod Type              [ QPSK ]
[C] Rx FEC Code Rate           [ Rate 1/2 ]
[D] Rx Data Rate                [ 64.000 ] Kbps
[E] Rx Symbol Rate             64.000 Ksps
[F] Rx Frequency                [ 1070.0000 ] MHz
[G] Rx Spectrum Invert         [ Normal ]
[H] Rx Descrambler              [ IESS315 ]
[I] Rx Acq Sweep Range         [ 10 ] kHz
[J] Rx Reed-Solomon Decoding    [ Normal ]
[K] Rx Data Invert              [ Normal ]
[L] Rx Data Clock Invert        [ Normal ]
[M] Rx Ternary Code             [ B8zs ]
[N] Rx Ebno Alarm Point         [ 0.1 ] dB
[O] Rx Equalizer Enable         [ Disabled ]
[P] Rx Submux                   [ Off ]
[Q] Rx Submux Ratio             [ 1/9 ] IP/Synchronous
[R] Rx Filter Rolloff Factor    [ Factor 0.35 ]

[ENTER]Select [ESC]Back [F5]Refresh [F8]Save [F10]Exit
    
```

Open the Modem RX page from the Modem submenu. This page contains the following options:

Hot Key	Dialog Window	Option Entry
A	Rx FEC Type	Use the ↑↓ arrow keys to select: <ul style="list-style-type: none"> • None Diff Enc On • Sequential • TCM Reed-Solomon • LDPC • VersaFEC-2 Long Block • Viterbi • Sequential Reed-Solomon • TPC • VersaFEC • VersaFEC-2 Short Block • Viterbi Reed-Solomon • TCM • None Diff Enc Off • ULL
B	Rx Mod Type	Use the ↑↓ arrow keys to select: <ul style="list-style-type: none"> • BPSK • 8PSK • QPSK • 16QAM • OQPSK • 8QAM
C	Rx FEC Code Rate	Use the ↑↓ arrow keys to select the Rx FEC Code Rate.  See the table provided in Sect. 6.2.1.4.4 CONFIG: Rx→Demod (Chapter 6. FRONT PANEL OPERATION) for the list of available FEC Rate Choices.
D	Rx Data Rate	Enter a value from 18.000 to 25000.000 Kbps  Data Rate applies only when not in ACM Mode
E	Rx Symbol Rate	Enter a value from 18.000 to 25000.000 Ksps  Symbol Rate applies when in ACM Mode

Hot Key	Dialog Window	Option Entry
F	Rx Frequency	Enter an Rx Frequency as follows: <ul style="list-style-type: none"> • Range 1 – From 50.0000 to 180.0000 MHz • Range 2 – From 950.0000 to 2250.0000 MHz
G	Rx Spectrum Invert	Use the ↑↓ arrow keys to select Normal or Inverted
H	Rx Descrambler	Use the ↑↓ arrow keys to select Off , Normal , or IESS315
I	Rx Acq Sweep Range	Enter a value from 1 to 200 kHz
J	Rx Reed-Solomon Decoding	Use the ↑↓ arrow keys to select Normal , IESS410 , EF Data , or IBS
K	Rx Data Invert	Typical for either entry – Use the ↑↓ arrow keys to select Normal or Inverted
L	Rx Data Clock Invert	
M	Rx Ternary Code	Use the ↑↓ arrow keys to select AMI , B8zs , B6zs , or Hdb3
N	Rx EbNo Alarm Point	Enter a value from 0.1 to 16.0 dB
O	Rx Equalizer Enable	Use the ↑↓ arrow keys to select Disabled or Enabled
P	Rx Submux	Use the ↑↓ arrow keys to select Off or On
Q	Rx Submux Ratio	Use the ↑↓ arrow keys to select the IP/Synchronous setting: <ul style="list-style-type: none"> • 1/9 • 1/8 • 1/7 • 1/6 • 1/5 • 1/4 • 2/7 • 1/3 • 2/5 • 3/7 • 1/2 • 3/5 • 2/3 • 3/4 • 4/5 • 1/1 • 5/4 • 4/3 • 3/2 • 5/3 • 2/1 • 7/3 • 5/2 • 3/1 • 7/2 • 4/1 • 5/1 • 6/1 • 7/1 • 8/1 • 9/1 • 1/59 • 1/39 • 1/19
R	Rx Filter Rolloff Factor	Use the ↑↓ arrow keys to select an Rx Rolloff Factor of 0.12 or 0.35

Press a hot key to open a dialog window. Otherwise, press **[ESC]** to return to the Modem submenu.

9.3.3.4 Home > Modem > Carrier-in-Carrier (CnC)



Appendix F. DOUBLETALK CARRIER-IN-CARRIER (CNC) OPTION

```

CDM-625/A: Home > Modem > CnC

[A] CnC Mode [ Off ]
[B] CnC Search Min Delay [ 10 ] mill-second
[C] CnC Search Max Delay [ 290 ] mill-second
[D] CnC Frequency Offset [ 30 ] KHz
[E] CnC PMSI Mode [ Idle ]

[ENTER] Select [ESC] Back [F5] Refresh [F8] Save [F10] Exit
    
```

Open the Carrier-in-Carrier (CnC) page from the Modem submenu. This page contains the following options:

Hot Key	Dialog Window	Option Entry
A	CnC Mode	Use the ↑↓ arrow keys to select: <ul style="list-style-type: none"> • Off • On Normal • APC CBand Side A • APC XBand Side A • APC KuBand Side A • APC KaBand Side A • APC CBand Side B • APC XBand Side B • APC KuBand Side B • APC KaBand Side B
B	CnC Search Min Delay	Enter a minimum value from 0 to 330 ms
C	CnC Search Max Delay	Enter a maximum value from 0 to 330 ms
D	CnC Frequency Offset	Enter a value from 1 to 200 KHz
E	CnC PMSI Mode	Use the ↑↓ arrow keys to select Idle , Redundancy , Talk , or Listen

Press a hot key to open a dialog window. Otherwise, press [ESC] to return to the Modem submenu.

9.3.3.5 Home > Modem > Adaptive Coding and Modulation (ACM)



Appendix M. ADAPTIVE CODING AND MODULATION (ACM) OPTION

```

CDM-625/A: Home > Modem > ACM

[A] ACM Min Tx Mod Cod           [ 0 ]
[B] ACM Max Tx Mod Cod           [ 11 ]
[C] ACM Action On Remote Demod Unlock [ Go To Min Tx ModCod ]
[D] ACM Target Eb No Margin      [ 1.0 ] dB
Reference for setting Min Tx Mod Cod and Max Tx Mod Cod
ModCod 0 - BPSK 0.488
ModCod 1 - QPSK 0.533
ModCod 2 - QPSK 0.631
ModCod 3 - QPSK 0.706
ModCod 4 - QPSK 0.803
ModCod 5 - 8-QAM 0.642
ModCod 6 - 8-QAM 0.711
ModCod 7 - 8-QAM 0.780
ModCod 8 - 16-QAM 0.731
ModCod 9 - 16-QAM 0.780
ModCod 10 - 16-QAM 0.829
ModCod 11 - 16-QAM 0.853

[ENTER]Select [ESC]Back [F5]Refresh [F8]Save [F10]Exit
    
```

Open the ACM page from the Modem submenu. Use this page as a quick reference guide for the Minimum and Maximum Tx ModCod settings. This submenu contains the following options:

Hot Key	Dialog Window	Option Entry
A	ACM Min Tx Mod Cod	Enter a minimum value from 0 to 11
B	ACM Max Tx Mod Cod	Enter a maximum value from 0 to 11
C	ACM Action on Remote Demod Unlock	Use the $\uparrow\downarrow$ arrow keys to select Go To Min Tx ModCod or Maintain Tx ModCod
D	ACM Target Eb No Margin	Enter a value from 0.0 to 4.5 dB

Press a hot key to open a dialog window. Otherwise, press **[ESC]** to return to the Modem submenu.

9.3.3.6 Home > Modem > Drop and Insert (D&I)



Appendix E. CLOCK MODES AND DROP AND INSERT (D&I)

```

CDM-625/A: Home > Modem > D&I

[A] Drop Type                [ T1 D4 ]
[B] Insert Type              [ T1 D4 ]
[C] Tx Terrestrial Alarm Mask [ Alarm Masked ]
[D] Rx Terrestrial Alarm Enable [ Disable ]

[E] D&I Table
[F] D&I++ Table
[G] D&I Quad Table

[ENTER] Select [ESC] Back [F5] Refresh [F8] Save [F10] Exit
    
```

Open the Drop and Insert (D&I) page from the Modem page. This page contains the following options:

Hot Key	Dialog Window	Option Entry
A	Drop Type	Typical for either entry – Use the ↑↓ arrow keys to select T1D4 , T1ESF , E1CCS , or E1CAS
B	Insert Type	
C	Tx Terrestrial Alarm Mask	Use the ↑↓ arrow keys to select Alarm Active or Alarm Masked
D	Rx Terrestrial Alarm Enable	Use the ↑↓ arrow keys to select Disable or Enable
E	D&I Table	See Sect. 9.3.3.6.1 for details
F	D&I++ Table	
G	D&I Quad Table	

Press a hot key to open a dialog window. Otherwise, press **[ESC]** to return to the Modem submenu.

9.3.3.6.1 Home > Modem > Drop and Insert (D&I) > D&I Tables

From the Drop and Insert (D&I) page, press **E** (D&I Table), **F** (D&I++ Table) or **G** D&I Quad Table to continue.

Typical for any table, enter a new value, and then press **[ENTER]** to accept the change or **[ESC]** to return to the D&I page.

- **Hot Key [E] – D&I Table**

```
CDM-625/A: Home > Modem > D&I > D&I Table
Note: Values can be pasted into input box
[A] Drop And Insert
[ 1234567
      Drop And Insert
      Current Value : 123456789ABCDEFGHIJKLMNO0123456789ABCDE
      GHIJKLMNO00
      New Value : █
      [ENTER] Accept [ESC] Back [UP/DOWN] Select
[ENTER]Select [ESC]Back [F5]Refresh [F8]Save [F10]Exit
```

The D&I Table dialog window shows the current value for the table. To edit the table value, press **A**, and then enter a new value*. Press **[ENTER]** to accept the change or **[ESC]** to return to the D&I dialog window.



*** For correct syntax, see the DNI Command/Query Description of Arguments column, SECT. 8.5.5 Bulk Configuration Strings, page 8-45 in CHAPTER 8. SERIAL-BASED REMOTE PRODUCT MANAGEMENT.**

- **Hot Key [F] – D&I++ Table**

```
CDM-625/A: Home > Modem > D&I > D&I++ Table
Note: Values can be pasted into input box
[A] Drop And Insert Plus Plus
[ 1234567 ]
      Drop And Insert Plus Plus
      Current Value : 123456789ABCDEFGHIJKLMNOPQRSTUVWXYZ0123456
      789ABCDEFGHIJKLMNOPQRSTUVWXYZ0
      New Value : █
      [ENTER] Accept [ESC] Back [UP/DOWN] Select
[ENTER]Select [ESC]Back [F5]Refresh [F8]Save [F10]Exit
```

9.3.3.7 Home > Modem > Block Upconverter (BUC)

```

CDM-625/A: Home > Modem > BUC

[A] BUC DC Power                [ Disable ]
[B] BUC 10 MHz Reference        [ Off ]
[C] BUC RF Output               [ Off ]
[D] BUC Low Current Limit       [ 0 ] mA
[E] BUC High Current Limit      [ 2000 ] mA
[F] BUC LO Frequency           [ 0 ] MHz
[G] BUC LO Mix                  [ High Side Mix ]
[H] BUC Address                  [ 1 ]

Status
BUC Alarms                      No Faults
BUC Current                      0 mA
BUC Voltage                      0.0 volts
BUC Power Level                  0.0 dBm
BUC Temperature                  0 degrees Celsius
BUC Power Class                  0 watts
BUC Phase Lock Loop              Unlocked
BUC Software Version             0

[ENTER] Select [ESC] Back [F5] Refresh [F8] Save [F10] Exit
    
```

Open the Block Upconverter (BUC) page from the Modem submenu. This page features a read-only status section for the installed device and contains the following options:

Hot Key	Dialog Window	Option Entry
A	BUC DC Power	Use the ↑↓ arrow keys to select Disable or Enable
B	BUC 10 MHz Reference	Typical for either entry – Use the ↑↓ arrow keys to select Off or On
C	BUC RF Output	
D	BUC Low Current Limit	Enter a low limit value from 0 to 4000 mA
E	BUC High Current Limit	Enter a high limit value from 0 to 4000 mA
F	BUC LO Frequency	Enter a value as follows: <ul style="list-style-type: none"> • Range 1 – From 0 to 0 MHz • Range 2 – From 3000 to 65000 MHz
G	BUC LO Mix	Use the ↑↓ arrow keys to select Low Side Mix or High Side Mix
H	BUC Address	Enter a value from 1 to 15

Press a hot key to open a dialog window. Otherwise, press **[ESC]** to return to the Modem submenu.

9.3.3.8 Home > Modem > (Low-Noise Block Downconverter) LNB

```

CDM-625/A: Home > Modem > LNB

[A] LNBDC Power                [ Off ]
[B] LNB 10 MHz Reference       [ Disable ]
[C] LNB Low Current Limit      [ 0 ] mA
[D] LNB High Current Limit     [ 500 ] mA
[E] LNB LO Frequency          [ 0 ] MHz
[F] LNB LO Mix                 [ High Side Mix ]

Status
LNB Alarms                     No Faults
LNB Current                    0 mA
LNB Voltage                    0.0 volts

[ENTER] Select [ESC] Back [F5] Refresh [F8] Save [F10] Exit
    
```

Open the (Low-Noise Block Downconverter) LNB page from the Modem submenu. This page provides a read-only status section for the installed device and contains the following options:

Hot Key	Dialog Window	Option Entry
A	LNB DC Power	Use the ↑↓ arrow keys to select Off , On 13V , On 18V , or On 24V
B	LNB 10 MHz Reference	Use the ↑↓ arrow keys to select Disable or Enable
C	LNB Low Current Limit	Enter a low limit value from 0 to 500 mA
D	LNB High Current Limit	Enter a high limit value from 0 to 500 mA
E	LNB LO Frequency	Enter a value as follows: <ul style="list-style-type: none"> • Range 1 – From 0 to 0 MHz • Range 2 – From 3000 to 65000 MHz
F	LNB LO Mix	Use the ↑↓ arrow keys to select Low Side Mix or High Side Mix

Press a hot key to open a dialog window. Otherwise, press **[ESC]** to return to the Modem submenu.

9.3.3.9 Home > Modem > MEO (Medium-Earth Orbit) (FUTURE)



MEO (Medium Earth Orbit) and its associated functions are not supported in FW Ver. 1.2.4. Its hot key and nested screen, while selectable and viewable, are NON-FUNCTIONAL at this time.

9.3.3.10 Home > Modem > Utilities

```

CDM-625/A: Home > Modem > Utilities

Unit
[A] Unit Test Mode                [ Normal ]
[B] Statistics Sample Interval    [ 10 Minutes ]
[C] Request To Send              [ Loop No Action ]
[D] HSSI Handshake Control       [ TA To CA Loop ]
[E] Circuit ID
[ TM2                             ]
[F] Carrier ID                   [ Disable ]

Date and Time
[G] RTC Time                     [ 11:04:11 ]
[H] RTC Date                     [ 22/07/13 ]

Clocks
[I] Tx Clock Source              [ Internal ]
[J] Rx Clock Source              [ Rx Satellite ]
[K] Rx Buffer Size               [ 16 ]
[L] Modem Reference Clock       [ Internal ]
[M] G703 Clock Extend Mode      [ None ]
[N] G703 Clock Extend Intf     [ T1 ]

Internal Reference
[O] Warm Up Delay                [ Disable ]
[P] Warm Up Countdown           [ 0 ] secs

BERT
BERT Result Err                  0
BERT Result BER                  2.14748E-1
BERT Sync State                  No Sync
[Q] BERT Restart Monitor        [ No ]
[R] BERT Tx State                [ Off ]
[S] BERT Tx Pattern              [ BERT Pattern 2047 ]
[T] BERT Rx State                [ Off ]
[U] BERT Rx Pattern              [ BERT Pattern 2047 ]
[V] BERT 10^-3 Error Insert     [ On ]

Miscellaneous
[W] Recenter Buffer               [ No ]

[ENTER]Select [ESC]Back [F5]Refresh [F8]Save [F10]Exit

```

Open the scrollable Utilities page from the Modem submenu. This page contains the following options:

Hot Key	Dialog Window	Option Entry
A	Unit Test Mode	Use the ↑↓ arrow keys to select <ul style="list-style-type: none"> • Normal • IF Loopback • I/O Loopback • Tx CW • RF Loopback • Tx Alt10 Pattern • Digital Loopback
B	Statistics Sample Interval	Use the ↑↓ arrow keys to select Disabled , or 10 minutes to 90 minutes

Hot Key	Dialog Window	Option Entry
C	Request To Send	Use the ↑↓ arrow keys to select Loop No Action , Loop RTS Controls Tx Output , or Ignore RTS Assert CTS
D	HSSI Handshake Control	Use the ↑↓ arrow keys to select TA To CA Loop or RR Control CA TA Control TxS
E	Circuit ID	Enter a Circuit ID value as needed
F	Carrier ID	Use the ↑↓ arrow keys to select Disable or Enable
G	RTC Time	Enter a value in the form HH:MM:SS
H	RTC Date	Enter a value in the form DD:MM:YY
I	Tx Clock Source	Use the ↑↓ arrow keys to select Internal , Tx Terrestrial , Rx Loop Timed , or Rx Sat
J	Rx Clock Source	Use the ↑↓ arrow keys to select Rx Satellite , Tx Terrestrial , Internal SCT , or Insert
K	Rx Buffer Size	Enter a value from 16 to 32768
L	Modem Reference Clock	Use the ↑↓ arrow keys to select: <ul style="list-style-type: none"> • Internal • External 1 MHz • External 2 MHz • External 5 MHz • External 10 MHz • Internal Plus Output
M	G703 Clock Extend Mode	Use the ↑↓ arrow keys to select None , Tx Lock , or Rx Enable
N	G703 Clock Extend Intf	Use the ↑↓ arrow keys to select T1 , E1 Balanced , or E1 Unbalanced
O	Warm Up Delay	Use the ↑↓ arrow keys to select Disable or Enable
P	Warm Up Countdown	Enter a value from 0 to 999 seconds
Q	BERT Restart Monitor	Use the ↑↓ arrow keys to select No or Yes
R	BERT Tx State	Use the ↑↓ arrow keys to select Off or On
S	BERT Tx Pattern	Typical for either entry – Use the ↑↓ arrow keys to select: <ul style="list-style-type: none"> • BERT Pattern Space • BERT Pattern Mark • BERT Pattern 11 • BERT Pattern 12 • BERT Pattern 63 • BERT Pattern 511 • BERT Pattern 2047 • BERT Pattern 2047 R • BERT Pattern MIL188 • BERT Pattern 2^15 • BERT Pattern 2^20 • BERT Pattern 2^23
U	BERT Rx Pattern	
T	BERT Rx State	Typical for each entry – Use the ↑↓ arrow keys to select Off or On
V	BERT 10^-3 Error Insert	
W	Recenter Buffer	

Press a hot key to open a dialog window. Otherwise, press **[ESC]** to return to the Modem submenu.

9.3.3.11 Home > Modem > Overhead

```

CDM-625/A: Home > Modem > Overhead

Engineering Service Channel (ESC)
[A] IDR Tx ESC Type           [ 64k Data Channel ]
[B] IDR Rx ESC Type           [ 64k Data Channel ]
[C] Tx Audio Volume Port1     [ Zero ]
[D] Tx Audio Volume Port2     [ Zero ]
[E] Rx Audio Volume Port1     [ Zero ]
[F] Rx Audio Volume Port2     [ Zero ]
[G] High Rate ESC              [ Disabled ]
[H] High Rate ESC Parameters  [ 300 ]

IDR Backward Alarms
[I] Tx Backward Alarm Enable Port1 [ Off ]
[J] Tx Backward Alarm Enable Port2 [ Off ]
[K] Tx Backward Alarm Enable Port3 [ Off ]
[L] Tx Backward Alarm Enable Port4 [ Off ]
[M] Rx Backward Alarm Enable Port1 [ Off ]
[N] Rx Backward Alarm Enable Port2 [ Off ]
[O] Rx Backward Alarm Enable Port3 [ Off ]
[P] Rx Backward Alarm Enable Port4 [ Off ]

Automatic Uplink Power Control (AUPC)
[Q] AUPC Enable                [ Disable ]
[R] AUPC Remote Demod Target Eb No [ 4.0 ] dB
[S] AUPC Tx Power Max Increase [ 3 ] dB
[T] AUPC Action On Max Power    [ No Action ]
[U] AUPC Action On Remote Demod Unlock [ Go To Nominal Power ]

Embedded Distant-end Monitor and Control (EDMAC)
[V] EDMAC Mode                  [ Off ]
[W] EDMAC Address                [ 20 ]

[ENTER]Select [ESC]Back [F5]Refresh [F8]Save [F10]Exit
    
```

Open the scrollable Overhead page from the Modem submenu. This page contains the following options:

Hot Key	Dialog Window	Option Entry
A	IDR Tx ESC Type	Typical for either entry – Use the ↑↓ arrow keys to select 64k Data Channel or 2 Audio Channels
B	IDR Rx ESC Type	
C	Tx Audio Volume Port 1	Typical for each entry – Use the ↑↓ arrow keys to select: <ul style="list-style-type: none"> • Negative6 • Negative4 • Negative2 • Zero • Positive2 • Positive4 • Positive6 • Positive8
D	Tx Audio Volume Port 2	
E	Rx Audio Volume Port 1	
F	Rx Audio Volume Port 2	
G	High Rate ESC	Use the ↑↓ arrow keys to select Disabled or Enabled
H	High Rate ESC Parameters	 See Sect. 6.2.1.10.6 CONFIG: Misc → HiRateESC in Chapter 6. FRONT PANEL OPERATION for details

Hot Key	Dialog Window	Option Entry
I	Tx Backward Alarm Enable Port1	Typical for each entry – Use the ↑↓ arrow keys to select Off or On
J	Tx Backward Alarm Enable Port2	
K	Tx Backward Alarm Enable Port3	
L	Tx Backward Alarm Enable Port4	
M	Rx Backward Alarm Enable Port1	
N	Rx Backward Alarm Enable Port2	
O	Rx Backward Alarm Enable Port3	
P	Tx Backward Alarm Enable Port4	
Q	AUPC Enable	Use the ↑↓ arrow keys to select Disable or Enable
R	AUPC Remote Demod Target Eb No	Enter a value from 0.0 to 14.9 dB
S	AUPC Tx Power Max Increase	Enter a value from 0 to 9 dB
T	AUPC Action On Max Power	Use the ↑↓ arrow keys to select No Action , Generate Tx Alarm Max Power , or Generate Tx Alarm Minimum ModCod
U	AUPC Action On Remote Demod Unlock	Use the ↑↓ arrow keys to select Go To Nominal Power , Go To Max Power , or Hold
V	EDMAC Mode	Use the ↑↓ arrow keys to select Off , Master , or Slave
W	EDMAC Address	Enter a value from 0 to 9999

Press a hot key to open a dialog window. Otherwise, press **[ESC]** to return to the Modem submenu.

9.3.4 Home > Network Submenu

```

CDM-625/A: Home > Network

[A] Ethernet Ports
[B] LAN IP
[C] LAN ARP
[D] VLAN
[E] Routes
[F] Managed Switch
[G] IGMP
[H] DNS
[I] DHCP
[J] PTP
[K] SNTP
[L] MAC Table

[ENTER] Select [ESC] Back [F5] Refresh [F10] Exit
    
```

Open the Network submenu from the Home menu. This submenu contains the following options:

Hot Key	Configuration Page	Function	Sect.
A	Ethernet Ports	Configure Ethernet Ports 1 through 4	9.3.4.1
B	LAN IP	Configure Ethernet Framing, IP addresses, QoS, Working Mode, Packet Processor parameters	9.3.4.2
C	LAN ARP	Configure LAN ARP operation and table entries	9.3.4.3
D	VLAN	Configure VLAN operation and table entries	9.3.4.4
E	Routes	Enter static routes into the IP Packet Processor to route IP traffic over the satellite or to another device on the local LAN	9.3.4.5
F	Managed Switch	Configure Header and Payload Compression and Encryption operations	9.3.4.6
G	IGMP	Configure use of IGMP (Internet Group Management Protocol) with configured multicast routes	9.3.4.7
H	DNS	Configure use of DNS (Domain Name System) caching function	9.3.4.8
I	DHCP	Configure use of DHCP (Dynamic Host Configuration Protocol) Relay function	9.3.4.9
J	PTP	Configure use and review status of PTP (Precision Time Protocol) feature	9.3.4.10
K	Sntp	Configure use of SNTP (Simple Network Time Protocol) feature, set RTC (Real Time Clock) time and date	9.3.4.11
L	MAC Table	View the MAC Addresses that the modem has discovered on one or more of its Ethernet switch ports	9.3.4.12

Press a hot key to access a configuration page. See the specified chapter section for further configuration options. Otherwise, press **[ESC]** to return to the Home menu.

9.3.4.1 Home > Network > Ethernet Ports

```
CDM-625/A: Home > Network > Ethernet Ports

<Ethernet Port 1>
Ethernet Ports Speed           Auto
Ethernet Port Pause Flow Control Off
Ethernet Port Mode             Trunk
Ethernet PVID                  0
Ethernet Port Priority          1
Ethernet Ports Actual Neg Speed Full 100 Mbps
Note: When changing Ethernet Port Mode to Access,
      a valid (non-zero) Ethernet PVID is needed

<Ethernet Port 2>
Ethernet Ports Speed           Auto
Ethernet Port Pause Flow Control Off
Ethernet Port Mode             Access
Ethernet PVID                  1
Ethernet Port Priority          1
Ethernet Ports Actual Neg Speed Link Down
Note: When changing Ethernet Port Mode to Access,
      a valid (non-zero) Ethernet PVID is needed

<Ethernet Port 3>
Ethernet Ports Speed           Auto
Ethernet Port Pause Flow Control Off
Ethernet Port Mode             Access
Ethernet PVID                  1
Ethernet Port Priority          1
Ethernet Ports Actual Neg Speed Link Down
Note: When changing Ethernet Port Mode to Access,
      a valid (non-zero) Ethernet PVID is needed

<Ethernet Port 4>
Ethernet Ports Speed           Auto
Ethernet Port Pause Flow Control Off
Ethernet Port Mode             Access
Ethernet PVID                  1
Ethernet Port Priority          1
Ethernet Ports Actual Neg Speed Link Down
Note: When changing Ethernet Port Mode to Access,
      a valid (non-zero) Ethernet PVID is needed

[ENTER]Select [ESC]Back [F5]Refresh [F8]Save [F10]Exit
```

Open the scrollable Ethernet Ports page from the Network submenu. This page lists the current configuration settings for Ethernet Ports 1 through 4.

Use the **↑↓** arrow keys to select **<Ethernet Port 1>**, **<Ethernet Port 2>**, **<Ethernet Port 3>**, or **<Ethernet Port 4>**, and then press **[ENTER]** to continue.

9.3.4.1.1 Home > Network > Ethernet Ports > Ethernet Port

```

CDM-625/A: Home > Network > Ethernet Ports > Ethernet Port 1

[A] Ethernet Ports Speed           [ Auto ]
[B] Ethernet Port Pause Flow Control [ Off ]
[C] Ethernet Port Mode             [ Trunk ]
[D] Ethernet PVID                  [ 0 ]
[E] Ethernet Port Priority          [ 1 ]
Ethernet Ports Actual Neg Speed    Full 100 Mbps
Note: When changing Ethernet Port Mode to Access,
      a valid (non-zero) Ethernet PVID is needed

[ENTER] Select [ESC] Back [F5] Refresh [F8] Save [F10] Exit
    
```

Open the nested **Ethernet Port 1** through **Ethernet Port 4** pages from the scrollable **Home > Network > Ethernet Ports** page. Each page contains the following options:

Hot Key	Dialog Window	Option Entry
A	Ethernet Ports Speed	Use the ↑↓ arrow keys to select: <ul style="list-style-type: none"> • Auto • Full 100 Mbps • Half 100 Mbps • Full 10 Mbps • Half 10 Mbps
B	Ethernet Ports Pause Flow Control	Use the ↑↓ arrow keys to select Off or On
C	Ethernet Port Mode	Use the ↑↓ arrow keys to select Trunk or Access
D	Ethernet PVID	Enter a value from 1 to 4095
E	Ethernet Port Priority	Enter a priority value from 1 to 4

Press a hot key to open a dialog window. Otherwise, press **[ESC]** to return to the Ethernet Ports page.

9.3.4.2 Home > Network > LAN IP

```

CDM-625/A: Home > Network > LAN IP

MAC Address                00:06:B0:01:63:FD
[A] 2048-byte Ethernet Frames [ Disabled ]
[B] Default Gateway         [ 192.168.1.128 ]
[C] IP Address              [ 192.168.1.11 ]
[D] IP Network Prefix       [ 24 ]
[E] Switch MAC Learning    [ On ]
[F] L2 QoS                  [ Off ]
[G] L3 QoS                  [ Off ]
[H] Working Mode            [ Managed Switch ]
[I] Packet Processor Enable [ Enabled ]

[ENTER] Select [ESC] Back [F5] Refresh [F8] Save [F10] Exit
    
```

Open the LAN IP page from the Network submenu. This page contains the following options:

Hot Key	Dialog Window	Option Entry
A	2048-byte Ethernet Frames	Use the ↑↓ arrow keys to select Disabled or Enabled
B	Default Gateway	Typical for either entry – Enter an IP address in the form XXX.XXX.XXX.XXX
C	IP Address	
D	IP Network Prefix	Enter a value from 8 to 30
E	Switch MAC Learning	Use the ↑↓ arrow keys to select Off or On
F	L2 QoS	Use the ↑↓ arrow keys to select Off , VLAN Prio Only , Port Prio Only , or VLAN and Port Prio
G	L3 QoS	Use the ↑↓ arrow keys to select Off , Advanced QoS Max Priority , Advanced QoS Min Max , or Advanced QoS DiffServ
H	Working Mode	Use the ↑↓ arrow keys to select Managed Switch , Router Point-to-Point , Router Multipoint Hub , or Router Multipoint Remote
I	Packet Processor Enable	Use the ↑↓ arrow keys to select Disabled or Enabled

Press a hot key to open a dialog window. Otherwise, press **[ESC]** to return to the Network submenu.

9.3.4.3 Home > Network > LAN ARP

```
CDM-625/A: Home > Network > ARP

[A] ARP Table
[B] Flush Dynamic ARP Entries      [ Cancel ]

[ENTER]Select [ESC]Back [F5]Refresh [F8]Save [F10]Exit
```

Open the LAN ARP page from the Network submenu. This page contains the following options:

Hot Key	Dialog Window	Option Entry
A	ARP Table	Use the ↑↓ arrow keys to select a table – see Sect. 9.3.4.3.1 .
B	Flush Dynamic ARP Entries	Use the ↑↓ arrow keys to select Cancel or Flush

Press a hot key to view the ARP Table or open the dialog window. Otherwise, press **[ESC]** to return to the Network submenu.

9.3.4.4 Home > Network > VLAN

```
CDM-625/A: Home > Network > VLAN

[A] VLAN Table
[B] VLAN Mode Enable           [ Disabled ]
[C] Ethernet Management PVID   [ 1 ]

Note: VLAN IDs in the VLAN table cannot be changed. The entry must
      be deleted then recreated with the new ID.

[ENTER] Select [ESC] Back [F5] Refresh [F8] Save [F10] Exit
```

Open the VLAN submenu from the Network submenu. This submenu contains the following options:

Hot Key	Dialog Window	Option Entry
A	VLAN Table	Use the ↑↓ arrow keys to select a table – see Sect. 9.3.4.3.1
B	VLAN Mode Enable	Use the ↑↓ arrow keys to select Disabled or Enabled
C	Ethernet Management PVID	Enter a value from 1 to 4095

Press a hot key to open the VLAN Table or a dialog window. Otherwise, press **[ESC]** to return to the Network submenu.

9.3.4.4.1 Home > Network > VLAN > VLAN Table > VLAN

```

CDM-625/A: Home > Network > VLAN > VLAN Table

<VLAN 1>
VLAN Entry VID                1
VLAN Entry Port1 Property     Untagged
VLAN Entry Port2 Property     Untagged
VLAN Entry Port3 Property     Untagged
VLAN Entry Port4 Property     Untagged

[ENTER]Select [ESC]Back [F5]Refresh [F8]Save [F9]Add [F11]Delete [F10]Exit
    
```

Open the VLAN Table from the nested VLAN submenu. Use the $\uparrow\downarrow$ arrow keys to scroll through the available entries. You may also select a header (e.g., <VLAN 1>) and press **[ENTER]** to view, in a standalone window, a specific VLAN page as shown in this example:

```

CDM-625/A: Home > Network > VLAN > VLAN Table > VLAN 1

[A] VLAN Entry VID                [ 1 ]
[B] VLAN Entry Port1 Property     [ Untagged ]
[C] VLAN Entry Port2 Property     [ Untagged ]
[D] VLAN Entry Port3 Property     [ Untagged ]
[E] VLAN Entry Port4 Property     [ Untagged ]

[ENTER]Select [ESC]Back [F5]Refresh [F8]Save [F9]Add [F11]Delete [F10]Exit
    
```

Each available VLAN # page contains the following options:

Hot Key	Dialog Window	Option Entry
A	VLAN Entry VID	Enter a value from 1 to 4095
B	VLAN Entry Port1 Property	Typical for each entry – Use the $\uparrow\downarrow$ arrow keys to select Tagged , Filtered , or Untagged
C	VLAN Entry Port2 Property	
D	VLAN Entry Port3 Property	
E	VLAN Entry Port4 Property	

Typical for any accessed VLAN table, press a hot key to open a dialog window. Otherwise, press **[ESC]** twice to return to the Network submenu.

9.3.4.5 Home > Network > Routes

```
CDM-625/A: Home > Network > Routes
[A] Route Table
[B] Delete all Route Entries          [ No ]
[ENTER] Select [ESC] Back [F5] Refresh [F8] Save [F10] Exit
```

Open the Routes page from the Network submenu. This page contains the following options:

Hot Key	Dialog Window	Option Entry
A	Route Table	Use the ↑↓ arrow keys to select an index – see Sect. 9.3.4.5.1
B	Delete All Route Entries	Use the ↑↓ arrow keys to select No or Yes

Press a hot key to open the Route Table or the dialog window. Otherwise, press **[ESC]** to return to the Network submenu.

9.3.4.5.1 Home > Network > Routes > Route Table

```

CDM-625/A: Home > Network > Routes > Route Table

<Index 1>
Route Description                default
Route Destination Address/Mask   0.0.0.0/0
Route Interface                  WAN
Route LAN Next Hop Address       0.0.0.0
Route Header Compression         Disable
Route Payload Compression        Disable
Route Encryption                 Disable
Route Encryption Key             Key 1

[ENTER]Select [ESC]Back [F5]Refresh [F8]Save [F9]Add [F11]Delete [F10]Exit
    
```

Open the Route Table from the nested Routes submenu. Use the $\uparrow\downarrow$ arrow keys to scroll through the available entries. You may also select a header (e.g., <Index 1>) and press **[ENTER]** to view, in a standalone window, a specific Route Index page as shown in this example:

```

CDM-625/A: Home > Network > Routes > Route Table > Index 1

[A] Route Description           [ default ]
[B] Route Destination Address/Mask [ 0.0.0.0/0 ]
[C] Route Interface             [ WAN ]
[D] Route LAN Next Hop Address  [ 0.0.0.0 ]
[E] Route Header Compression    [ Disable ]
[F] Route Payload Compression   [ Disable ]
[G] Route Encryption            [ Disable ]
[H] Route Encryption Key        [ Key 1 ]

[ENTER]Select [ESC]Back [F5]Refresh [F8]Save [F9]Add [F11]Delete [F10]Exit
    
```

Each available Index # page contains the following options:

Hot Key	Dialog Window	Option Entry
A	Route Description	Enter a description here
B	Route Destination Address/Mask	Enter an IP Address/Range in the form XXX.XXX.XXX.XXX/XX
C	Route Interface	Use the $\uparrow\downarrow$ arrow keys to select LAN or WAN
D	Route LAN Next Hop Address	Enter an IP Address in the form XXX.XXX.XXX.XXX
E	Route Header Compression	Typical for each entry – Use the $\uparrow\downarrow$ arrow keys to select Disable or Enable
F	Route Payload Compression	
G	Route Encryption	
H	Route Encryption Key	Use the $\uparrow\downarrow$ arrow keys to select Key 1 through Key 8 , or Random

Typical for any accessed Index # page, press a hot key to open a dialog window. Otherwise, press **[ESC]** twice to return to the Network submenu.

9.3.4.6 Home > Network > Managed Switch

```

CDM-625/A: Home > Network > Managed Switch

[A] Header Compression          [ Disable ]
[B] Payload Compression         [ Disable ]
[C] Encryption Feature          [ Disable ]
[D] Encryption Key Select       [ Key 1 ]

NOTE: Settings on this page affect Managed Switch mode only.

[ENTER] Select [ESC] Back [F5] Refresh [F8] Save [F10] Exit
    
```

Open the Managed Switch page from the Network submenu. This page contains the following options:

Hot Key	Dialog Window	Option Entry
A	Header Compression	Use the ↑↓ arrow keys to select Disable , Layer 2 Only , or Layer 2 And 3
B	Payload Compression	Typical for either entry – Use the ↑↓ arrow keys to select Disable or Enable
C	Encryption Feature	
D	Encryption Key Select	Use the ↑↓ arrow keys to select Key 1 through Key 8 , or Random

Press a hot key to open a dialog window. Otherwise, press **[ESC]** to return to the Network submenu.

9.3.4.7 Home > Network > IGMP (Internet Group Management Protocol)

```

CDM-625/A: Home > Network > IGMP

[A] IGMP Joined Groups
[B] Multicast Traffic

IGMP Multicast Router
[C] IGMP Version                [ IGMPv2 ]
[D] IGMP Last Member Query Interval [ 1 ] seconds
[E] IGMP Query Interval         [ 125 ] seconds
[F] IGMP Query Response Interval [ 10 ] seconds

[ENTER] Select [ESC] Back [F5] Refresh [F8] Save [F10] Exit
    
```

Open the IGMP page from the Network submenu. This page contains the following options:

Hot Key	Dialog Window	Option Entry
A	IGMP Joined Groups	Lists the IGMP Groups that are active on the modem. If none exist, this window displays the message <No IGMP Groups>
B	Multicast Traffic	Lists the Multicast Routes that are active on the modem. If none exist, this window displays the message <No IGMP Multicast Entries>
C	IGMP Version	Use ↑↓ arrow keys to select IGMPv1 , IGMPv2 , or IGMPv3
D	IGMP Last Member Query Interval	Enter a value from 1 to 25 seconds
E	IGMP Query Interval	Enter a value from 1 to 18000 seconds
F	IGMP Query Response Interval	Enter a value from 1 to 25 seconds

Press a hot key to open a dialog window. Otherwise, press **[ESC]** to return to the Network submenu.

9.3.4.8 Home > Network > DNS (Domain Name System)

```

CDM-625/A: Home > Network > DNS Caching

[A] DNS Caching Feature           [ Disable ]
[B] DNS Caching Flush             [ Cancel  ]

[ENTER] Select [ESC] Back [F5] Refresh [F8] Save [F10] Exit
    
```

Open the DNS Caching page from the Network submenu. This page contains the following options:

Hot Key	Dialog Window	Option Entry
A	DNS Caching Feature	Use the ↑↓ arrow keys to select Disable or Enable
B	DNS Caching Flush	Use the ↑↓ arrow keys to select Cancel or Flush

Press a hot key to open a dialog window. Otherwise, press **[ESC]** to return to the Network submenu.

9.3.4.9 Home > Network > DHCP (Dynamic Host Configuration Protocol)

```

CDM-625/A: Home > Network > DHCP Relay

[A] DHCP Relay Feature           [ Disable ]
[B] DHCP Relay IP Address        [ 0.0.0.0 ]

[ENTER] Select [ESC] Back [F5] Refresh [F8] Save [F10] Exit
    
```

Open the DHCP Relay page from the Network submenu. This page contains the following options:

Hot Key	Dialog Window	Option Entry
A	DHCP Relay Feature	Use the ↑↓ arrow keys to select Disable or Enable
B	DHCP Relay IP Address	Enter an IP Address in the form XXX.XXX.XXX.XXX

Press a hot key to open a dialog window. Otherwise, press **[ESC]** to return to the Network submenu.

9.3.4.10 Home > Network > PTP (Precision Time Protocol)

```

CDM-625/A: Home > Network > Precision Time Protocol (PTP)

[A] PTP Feature                [ Disabled ]
[B] PTP Grandmaster           [ LAN ]

Status
PTP Engine Status             Stopped
PTP Port                       2
PTP Time                      2013-07-23 12:27:44.718
PTP Offset                    0.0000000000
PTP LAN State                 Disabled
PTP WAN State                 Disabled

[ENTER] Select [ESC] Back [F5] Refresh [F8] Save [F10] Exit
    
```

Open the PTP (Precision Time Protocol) page from the Network submenu. This page contains the following options:

Hot Key	Dialog Window	Option Entry
A	PTP Feature	Use the ↑↓ arrow keys to select Disable or Enable
B	PTP Grandmaster	Use the ↑↓ arrow keys to select LAN or WAN

Press a hot key to open a dialog window. Otherwise, press **[ESC]** to return to the Network submenu.

9.3.4.11 Home > Network > SNTP (Simple Network Time Protocol)

```

CDM-625/A: Home > Network > Simple Network Time Protocol (SNTP)

[A] SNTP Enable                [ Disabled ]
[B] SNTP Primary Server        [ 192.168.1.10 ]
[C] SNTP Backup Server         [ 0.0.0.0 ]
SNTP Primary Last Update      Never
SNTP Backup Last Update       Never

Manual time/date adjustment
[D] RTC Time                   [ 12:32:04 ]
[E] RTC Date                   [ 23/07/13 ]

[ENTER] Select [ESC] Back [F5] Refresh [F8] Save [F10] Exit
    
```

Open the Simple Network Time Protocol (SNTP) page from the Network submenu. This page contains the following options:

Hot Key	Dialog Window	Option Entry
A	SNTP Enable	Use the ↑↓ arrow keys to select Disabled or Enabled
B	SNTP Primary Server	Typical for either entry – Enter an IP Address in the form XXX.XXX.XXX.XXX
C	SNTP Backup Server	
[R/O]	SNTP Primary Last Update	These read-only entries display the date/timestamp of the last updates – otherwise, if no updates have occurred, entries will read “Never”
[R/O]	SNTP Backup Last Update	
D	RTC Time	Enter a time in the form HH:MM:SS
E	RTC Date	Enter a date in the form DD:MM:YY

Press a hot key to open a dialog window. Otherwise, press **[ESC]** to return to the Network submenu.

9.3.4.12 Home > Network > MAC Table

```
CDM-625/A: Home > Network > MAC Table

<Index 1>
MAC Address          00:06:BO:01:63:FD
MACDB Num            0
MACCPU Port          Not Connected
MAC Port4            Not Connected
MAC Port3            Not Connected
MAC Port2            Not Connected
MAC Port1            Not Connected
MACWAN Port          Connected
MAC Type             Dynamic

<Index 2>
MAC Address          00:06:BO:01:E1:8E
MACDB Num            0
MACCPU Port          Connected
MAC Port4            Not Connected
MAC Port3            Not Connected
MAC Port2            Not Connected
MAC Port1            Not Connected
MACWAN Port          Not Connected
MAC Type             Static

<Index 3>
MAC Address          90:E2:BA:2B:A6:BB
MACDB Num            0
MACCPU Port          Not Connected
MAC Port4            Not Connected
MAC Port3            Not Connected
MAC Port2            Not Connected
MAC Port1            Connected
MACWAN Port          Not Connected
MAC Type             Dynamic

[ENTER] Select [ESC] Back [F5] Refresh [F10] Exit
```

Open the MAC Table page from the Network submenu. Use this page to review status information on the recognized MAC Addresses.

Use the **↑↓** arrow keys to scroll through the available indices. You may also press **[ENTER]** to select, and then view in a standalone window, a specific Index entry. Otherwise, press **[ESC]** to return to the Network submenu.

9.3.5 Home > WAN Submenu

```

CDM-625/A: Home > WAN

[A] QoS
[B] Compression
[C] Encryption

[ENTER] Select [ESC] Back [F5] Refresh [F10] Exit
    
```

Open the WAN submenu from the Home menu. This submenu contains the following options:

Hot Key	Configuration Page	Function	Sect.
A	QoS	Configure Quality of Service operation	0
B	Compression	Configure Router Mode compression refresh rates	9.3.5.2
C	Encryption	Configure Managed Switch Mode Encryption and define Encryption Keys 1 through 8	9.3.5.3

Press a hot key to access a configuration page. See the specified chapter section for further configuration options. Otherwise, press **[ESC]** to return to the Home menu.

9.3.5.1 Home > WAN > QoS Submenu

Open the QoS (Quality of Service) submenu from the WAN submenu. The appearance of this page changes with the selected Advanced QoS mode (see **Sect. 9.3.4.2 Home > Network > LAN IP**).

With Advanced QoS mode set to Max-Priority or Min-Max:

CDM-625/A: Home > WAN > QoS
[A] QoS Max-Pri / Min-Max Table [C] QoS SAR Feature [Disable] [D] Delete all Max-Pri / Min-Max rules [No]
[ENTER] Select [ESC] Back [F5] Refresh [F8] Save [F10] Exit

With Advanced QoS mode set to DiffServ:

CDM-625/A: Home > WAN > QoS
[B] QoS Differentiated Services Table [C] QoS SAR Feature [Disable] [D] Delete all Max-Pri / Min-Max rules [No]
[ENTER] Select [ESC] Back [F5] Refresh [F8] Save [F10] Exit

This submenu contains the following options:

Hot Key	Page / Dialog Window	Description / Option Entry
A	QoS Max-Pri / Min-Max Table (visible only when Advanced QoS mode is set to Max-Priority or Min-Max)	See Sect. 0
B	QoS Differentiated Services Table (visible only when QoS mode is set to Differentiated Services)	See Sect. 9.3.5.1.2
C	QoS SAR Feature	Use the ↑↓ arrow keys to select Disable or Enable
D	Delete All Max-Pri / Min-Max rules	Use the ↑↓ arrow keys to select No or Yes

Press a hot key to open a dialog window. Otherwise, press **[ESC]** to return to the Network submenu.

9.3.5.1.1 Home > WAN > QoS > Max-Pri / Min-Max Table

```

CDM-625/A: Home > WAN > QoS > QoS Table

<Index 1>
QoS Rules Protocol                All
QoS Rules Min VLAN Id            4094
QoS Rules Max VLAN Id            4094
QoS Rules TOS                     255
QoS Rules Src IP Addr/Mask       0.0.0.0/0
QoS Rules Dst IP Addr/Mask       0.0.0.0/0
QoS Rules Src Port Min           0
QoS Rules Src Port Max           65535
QoS Rules Dst Port Min           0
QoS Rules Dst Port Max           65535
QoS Rules Min Bw                  0 Kbps
QoS Rules Max Bw                  99999 Kbps
QoS Rules Priority                 1
QoS Rules WRED                    Disable
QoS Rules Filter                  Disable

[ENTER]Select [ESC]Back [F5]Refresh [F8]Save [F9]Add [F11]Delete [F10]Exit

```

Open the scrollable QoS Table (Max-Pri / Min-Max Table) from the QoS submenu.

Use the **↑↓** arrow keys to scroll through the available entries. You may also select a header (e.g., <Index 1>) and press **[ENTER]** to view, in a standalone window, a specific set of statistics as shown in this example:

```

CDM-625/A: Home > WAN > QoS > QoS Table > Index 1

[A] QoS Rules Protocol                [ All ]
[B] QoS Rules Min VLAN Id            [ 4094 ]
[C] QoS Rules Max VLAN Id            [ 4094 ]
[D] QoS Rules TOS                     [ 255 ]
[E] QoS Rules Src IP Addr/Mask       [ 0.0.0.0/0 ]
[F] QoS Rules Dst IP Addr/Mask       [ 0.0.0.0/0 ]
[G] QoS Rules Src Port Min           [ 0 ]
[H] QoS Rules Src Port Max           [ 65535 ]
[I] QoS Rules Dst Port Min           [ 0 ]
[J] QoS Rules Dst Port Max           [ 65535 ]
[K] QoS Rules Min Bw                  [ 0 ] Kbps
[L] QoS Rules Max Bw                  [ 99999 ] Kbps
[M] QoS Rules Priority                 [ 1 ]
[N] QoS Rules WRED                    [ Disable ]
[O] QoS Rules Filter                  [ Disable ]

[ENTER]Select [ESC]Back [F5]Refresh [F8]Save [F9]Add [F11]Delete [F10]Exit

```

Press **[ESC]** to return to the QoS submenu.

9.3.5.1.2 Home > WAN > QoS > QoS Differentiated Services Table

```

CDM-625/A: Home > WAN > QoS > QoS Differentiated Services

Note: Settings on this page only apply when L3 QoS is set to DiffServ

Assured Forwarding Class 4
[A] AF4 Service Rate [ 16 ] Kbps
[B] AF4 Medium Drop Precedence Level [ 75 ] %
[C] AF4 High Drop Precedence Level [ 50 ] %

Assured Forwarding Class 3
[D] AF3 Service Rate [ 16 ] Kbps
[E] AF3 Medium Drop Precedence Level [ 75 ] %
[F] AF3 High Drop Precedence Level [ 50 ] %

Assured Forwarding Class 2
[G] AF2 Service Rate [ 16 ] Kbps
[H] AF2 Medium Drop Precedence Level [ 75 ] %
[I] AF2 High Drop Precedence Level [ 50 ] %

Assured Forwarding Class 1
[J] AF1 Service Rate [ 16 ] Kbps
[K] AF1 Medium Drop Precedence Level [ 75 ] %
[L] AF1 High Drop Precedence Level [ 50 ] %

[ENTER]Select [ESC]Back [F5]Refresh [F8]Save [F10]Exit
    
```

Open the nested QoS Differentiated Services page from the QoS submenu. This page contains the following options:

Hot Key	Dialog Window	Option Entry
A	AF4 Service Rate	Typical for each entry – Enter a value from 0 to 100000000 Kbps
D	AF3 Service Rate	
G	AF2 Service Rate	
J	AF1 Service Rate	
B	AF4 Medium Drop Precedence Level	Typical for each entry – Enter a value from 20 to 90 %
E	AF3 Medium Drop Precedence Level	
H	AF2 Medium Drop Precedence Level	
K	AF1 Medium Drop Precedence Level	
C	AF4 High Drop Precedence Level	Typical for each entry – Enter a value from 10 to 80 %
F	AF3 High Drop Precedence Level	
I	AF2 High Drop Precedence Level	
L	AF1 High Drop Precedence Level	

Press a hot key to open a dialog window. Otherwise, press **[ESC]** to return to the QoS submenu.

9.3.5.2 Home > WAN > Compression

```
CDM-625/A: Home > WAN > Compression

Router Mode Compression Settings
[A] Header Comp RTP Refresh Rate      [ 50 ]
[B] Header Comp UDP Refresh Rate      [ 50 ]
[C] Header Comp Default Refresh Rate  [ 50 ]
[D] Payload Comp Refresh Rate         [ 50 ]

[ENTER] Select [ESC] Back [F5] Refresh [F8] Save [F10] Exit
```

Open the Compression page from the WAN submenu. This page contains the following options:

Hot Key	Dialog Window	Option Entry
A	Header Comp RTP Refresh Rate	Typical for each entry – Enter a value from 1 to 600
B	Header Comp UTD Refresh Rate	
C	Header Comp Default Refresh Rate	
D	Payload Comp Refresh Rate	Enter a value from 1 to 255

Press a hot key to open a dialog window. Otherwise, press **[ESC]** to return to the WAN submenu.

9.3.5.3 Home >WAN > Encryption

```

CDM-625/A: Home > WAN > Encryption

[A] Allow Unencrypted Rx          [ Allow ]

Managed Switch Mode Encryption
[B] Encryption Feature            [ Disable ]
[C] Encryption Key Select         [ Key 1 ]

Router Mode Encryption
Enable or disable encryption in the route table.

Key Management
[D] Encryption Key1
[ 00000000000000000000000000000000 ]
[E] Encryption Key2
[ 00000000000000000000000000000000 ]
[F] Encryption Key3
[ 00000000000000000000000000000000 ]
[G] Encryption Key4
[ 00000000000000000000000000000000 ]
[H] Encryption Key5
[ 00000000000000000000000000000000 ]
[I] Encryption Key6
[ 00000000000000000000000000000000 ]
[J] Encryption Key7
[ 00000000000000000000000000000000 ]
[K] Encryption Key8
[ 00000000000000000000000000000000 ]
[L] Decryption Key1
[ 00000000000000000000000000000000 ]
[M] Decryption Key2
[ 00000000000000000000000000000000 ]
[N] Decryption Key3
[ 00000000000000000000000000000000 ]

[ENTER] Select [ESC] Back [F5] Refresh [F8] Save [F10] Exit
    
```

Open the Encryption page from the WAN submenu. This page contains the following options:

Hot Key	Dialog Window	Option Entry
A	Allow Unencrypted Rx	Use the ↑↓ arrow keys to select Drop or Allow
B	Encryption Feature	Use the ↑↓ arrow keys to select Disable or Enable
C	Encryption Key Select	Use the ↑↓ arrow keys to select Key1 through Key8 , or Random
D	Encryption Key 1	Typical for each key entry – Enter a 32-character encryption code
E	Encryption Key 2	
F	Encryption Key 3	
G	Encryption Key 4	
H	Encryption Key 5	Typical for each key entry – Enter a 32-character encryption code

Hot Key	Dialog Window	Option Entry
I	Encryption Key 6	
J	Encryption Key 7	
K	Encryption Key 8	
L	Decryption Key 1	Typical for each key entry – Enter a 32-character decryption code
M	Decryption Key 2	
N	Decryption Key 3	

Press a hot key to open a dialog window. Otherwise, press **[ESC]** to return to the WAN submenu.

9.3.6 Home > Outdoor Unit (ODU) Submenus (Summary Only)



1) After configuring the CDM-625A for 70/140 MHz operation, and then enabling ODU Comms, you may use the Telnet CLI 'ODU (Outdoor Unit)' submenus and pages to control and monitor a CSAT-5060 Outdoor Unit that is connected via FSK to the CDM-625A.

2) Comtech EF Data KST-2000A/B Transceivers and LPOD Outdoor Amplifiers / Block Up Converters (BUCs) are not supported by the Telnet CLI at this time.



See Chapter 10. CDM-625A ODU (TRANSCIVER, BUC, LNB) OPERATION for complete details about using this product-specific menu branch.

```
CDM-625/A: Home > Outdoor Unit (ODU)

[A] ODU Comms Enabled          [ Disabled ]
[B] CSAT-5060

[ENTER] Select [ESC] Back [F5] Refresh [F8] Save [F10] Exit
```

```
CDM-625/A: Home > Outdoor Unit (ODU) > CSAT-5060

[A] Select                      [ Csat1 ]

[B] Up Converter Settings (1/2)
[C] Up Converter Settings (2/2)
[D] Down Converter Settings (1/2)
[E] Down Converter Settings (2/2)
[F] Unit Settings (1/2)
[G] Unit Settings (2/2)
[H] LNA Settings
[I] Status
[J] Logs
[K] Redundancy
[L] Utilities

[ENTER] Select [ESC] Back [F5] Refresh [F8] Save [F10] Exit
```

9.3.7 Home > Redundancy Submenu

```

CDM-625/A: Home > Redundancy

[A] Traffic IP Address           [ 192.168.1.15 ]
[B] Traffic IP Network Prefix   [ 24 ]
[C] Redundancy 1-for-N Mode     [ Disabled ]
[D] Packet Processor Redundancy [ Disabled ]
[E] Force Redundant Switch      [ No Switch ]
Redundancy Status
Online. 1:1 Switch is Not connected.

Note: Force Redundant Switch applies to online modem in 1:1 mode

[ENTER] Select [ESC] Back [F5] Refresh [F8] Save [F10] Exit
    
```

Open the Redundancy submenu from the Home menu. This submenu additionally displays the status of the redundant modem setup. The redundant modem operation options are as follows:

Hot Key	Dialog Window	Option Entry
A	Traffic IP Address	Enter an IP address in the form XXX.XXX.XXX.XXX
B	Traffic IP Network Prefix	Enter a value from 8 to 30
C	Redundancy 1-for-N Mode	Typical for either entry – Use the ↑↓ arrow keys to select Disabled or Enabled
D	Packet Processor Redundancy	
E	Force Redundant Switch	Use the ↑↓ arrow keys to select No Switch or Force Switch

Press a hot key to open a dialog window. Otherwise, press **[ESC]** to return to the Home submenu.

9.3.8 Home > General Information Submenu

```
CDM-625/A: Home > General Information

[A] Modem Status
[B] Modem Information
[C] MAC Table
[D] Block Upconverter (BUC)
[E] Low Noise Block Downconverter (LNB)

[ENTER] Select [ESC] Back [F5] Refresh [F10] Exit
```

Open the General Information submenu from the Home menu. This submenu contains the following options:

Hot Key	Information Page	Sect.
A	Modem Status	9.3.8.1
B	Modem Information	9.3.8.2
C	MAC Table	9.3.8.3
D	Block Upconverter (BUC)	9.3.8.4
E	Low Noise Block Downconverter (LNB)	9.3.8.5

Press a hot key to access a read-only (except where noted) information page. See the specified chapter section for further information. Otherwise, press **[ESC]** to return to the Home menu.

9.3.8.1 Home > General Information > Modem Status

```
CDM-625/A: Home > General Information > Modem Status

Alarms
Unit Alarms                No Faults
Tx Alarms                  Tx Traffic OK
Rx Alarms                  Demodulator Unlocked
Open Network Alarms       No Faults
BUC Alarms                 No Faults
LNB Alarms                 No Faults

AUPC
AUPC Remote Demod Eb No    99.9 dB
AUPC Tx Power Increase     99.9 dB

ACM
Tx Mod Cod Description     Not Available
Rx Mod Cod Description     Not Available
Local SNR                  88.8 dB
Remote SNR                  88.8 dB

Fractional CnC Counters
NOTE: A value of [0] means CnC is Not Installed
Full Year Counter          3827831 seconds
Fractional CnC Counter     0 seconds

RX Parameters
Rx BER Multiplier          2.14748E-1
Rx Eb No                   99.9 dB
Rx Frequency Offset        999999.000 KHz
Rx Signal Level            LT-40 dBm
Buffer Fill State          38 percent

CnC
CnC Delay Monitor          999.999 ms
CnC Delay Offset Freq      9999.900 KHz
CnC Power Ratio            99.9 dB
CnC PSDR                   99.9 dB

General Status
Redundancy State           Online
Temperature                 35 degrees C

[ENTER]Select [ESC]Back [F5]Refresh [F8]Save [F10]Exit
```

Press **[ESC]** to return to the General Information submenu.

9.3.8.2 Home > General Information > Modem Information

```

CDM-625/A: Home > General Information > Modem Information

General Information
[A] Circuit ID
[ TM2 ]
Serial Number          000000000
Software Revision      2.3.1
Hardware Revision      02.1

Installed Options
Data Rate Option       Up To 25 Mbps
TPC Data Rate Option   Up To 25 Mbps
LDPC Data Rate Option  Up To 25 Mbps
CnC Data Rate Option   Up To 25 Mbps
VersaFEC Data Rate Option Up To 16 Mbps
ACM Symbol Rate Option Up To 4100 kbps
TPC/LDPC Codec         Installed
External 20 dB Attenuator Not Installed
DNI Option             Installed
8PSK 8QAM Option      Installed
16QAM Option           Installed
AES Option             Installed
Payload Compression Option Up To 25 Mbps
Advanced QoS Option    Installed
Header Compression Option Up To 25 Mbps
QDI Option             Installed
L-Band Option          Installed
Open Network Framing Option Installed
Audio Chips            Installed
CnC Module             Installed
VersaFEC Module        Installed
G.703 Clock Extension Option Installed
Fractional CnC Option  Not Installed
Packet Processor Card  Installed
Advanced Network Timing Option Installed
Carrier ID Option      Not Installed

[ENTER]Select [ESC]Back [F5]Refresh [F8]Save [F10]Exit
    
```

Open the Modem Information page from the General Information submenu. This page contains the following option:

Hot Key	Dialog Window	Option Entry
A	Circuit ID	Enter an identifying label for the modem

Press the hot key to open the dialog window. Otherwise, press **[ESC]** to return to the General Information submenu.

9.3.8.3 Home > General Information > MAC Table

```
CDM-625/A: Home > General Information > MAC Table

<Index 1>
MAC Address          00:06:B0:01:63:FD
MACDB Num            0
MACCPU Port          Not Connected
MAC Port4            Not Connected
MAC Port3            Not Connected
MAC Port2            Not Connected
MAC Port1            Not Connected
MACWAN Port          Connected
MAC Type              Dynamic

<Index 2>
MAC Address          00:06:B0:01:E1:8E
MACDB Num            0
MACCPU Port          Connected
MAC Port4            Not Connected
MAC Port3            Not Connected
MAC Port2            Not Connected
MAC Port1            Not Connected
MACWAN Port          Not Connected
MAC Type              Static

<Index 3>
MAC Address          90:E2:BA:2B:A6:BB
MACDB Num            0
MACCPU Port          Not Connected
MAC Port4            Not Connected
MAC Port3            Not Connected
MAC Port2            Not Connected
MAC Port1            Connected
MACWAN Port          Not Connected
MAC Type              Dynamic

[ENTER]Select [ESC]Back [F5]Refresh [F10]Exit
```

Press **[ESC]** to return to the General Information submenu.

9.3.8.4 Home > General Information > Block Upconverter (BUC)

CDM-625/A: Home > General Information > Block Upconverter (BUC)	
BUC Alarms	No Faults
BUC Current	0 mA
BUC Voltage	0 0.1 volt
BUC Power Level	0 0.1 watts
BUC Temperature	0 degrees Celsius
BUC Power Class	0 watts
BUC Phase Lock Loop	Unlocked
BUC Software Version	0
[ENTER] Select [ESC] Back [F5] Refresh [F8] Save [F10] Exit	

Press [ESC] to return to the General Information submenu.

9.3.8.5 Home > General Information > Low Noise Block Downconverter (LNB)

CDM-625/A: Home > General Information > Low Noise Block Downconverter (LNB)	
LNB Alarms	No Faults
LNB Current	0 mA
LNB Voltage	0 volt
[ENTER] Select [ESC] Back [F5] Refresh [F8] Save [F10] Exit	

Press [ESC] to return to the General Information submenu.

9.3.9 Home > Logs Submenu

```
CDM-625/A: Home > Logs

[A] Base Modem
[B] Packet Processor

[ENTER] Select [ESC] Back [F5] Refresh [F10] Exit
```

Open the Logs submenu from the Home menu. This submenu contains the following options:

Hot Key	Dialog Window	Sect.
A	Base Modem	9.3.9.1
B	Packet Processor	9.3.9.2

Press a hot key to access a submenu. See the specified chapter section for further information. Otherwise, press **[ESC]** to return to the Home menu.

9.3.9.1 Home > Logs > Base Modem

```

CDM-625/A: Home > Logs > Base Modem

[A] Stored Event Table
[B] Stored Statistic Table
[C] Clear All Stored Events          [ Cancel ]
[D] Clear All Stored Statistics      [ Cancel ]

Alarm Mask
[E] Alarm Mask Tx AIS              [ Masked ]
[F] Alarm Mask Rx AIS              [ Masked ]
[G] Alarm Mask Buffer Slip         [ Active ]
[H] Alarm Mask Rx AGC              [ Masked ]
[I] Alarm Mask Eb No               [ Active ]
[J] Alarm Mask BUC                 [ Active ]
[K] Alarm Mask LNB                 [ Active ]
[L] Alarm Mask G703 Loss Of Signal [ Active ]
[M] Alarm Mask Reference           [ Active ]
[N] Alarm Mask Tx Clock            [ Active ]

[ENTER] Select [ESC] Back [F5] Refresh [F8] Save [F10] Exit
    
```

Open the Base Modem page from the Logs submenu. This page contains the following options:

Hot Key	Dialog Window	Option Entry
A	Stored Event Table	See Sect. 9.3.9.1.1
B	Stored Statistic Table	See Sect. 9.3.9.1.2
C	Clear All Stored Events	Typical for either entry – Use the ↑↓ arrow keys to select Cancel or Clear
D	Clear All Stored Statistics	
E	Alarm Mask Tx AIS	Typical for each entry – Use the ↑↓ arrow keys to select Active or Masked
F	Alarm Mask Rx AIS	
G	Alarm Mask Buffer Slip	
H	Alarm Mask Rx AGC	
I	Alarm Mask Eb No	
J	Alarm Mask BUC	
K	Alarm Mask LNB	
L	Alarm Mask G703 Loss of Signal	
M	Alarm Mask Reference	
N	Alarm Mask Tx Clock	

Press a hot key to open a dialog window. See the specified chapter section for further information. Otherwise, press **[ESC]** to return to the Home menu.

9.3.9.1.1 Home > Logs > Base Modem > Stored Event Table

CDM-625/A: Home > Logs > Base Modem > Stored Event Table	
<Event 1>	
Event Date	04/06/13
Event Time	14:35:35
Event Description	Info - Log Erased
[ENTER] Select [ESC] Back [F5] Refresh [F8] Save [F10] Exit	

Open the scrollable Stored Event Table from the Base Modem page. Use the $\uparrow\downarrow$ arrow keys to scroll through the available entries. The date, time, and description are provided for each event. Events are numbered in the order logged, from the time the event logging buffer was last cleared.

Press **[ESC]** to return to the Base Modem page. Or, you may press **[ENTER]** to select, and then view in a standalone window, a specific stored event as shown in this example:

CDM-625/A: Home > Logs > Base Modem > Stored Event Table > Event 1	
Event Date	04/06/13
Event Time	14:35:35
Event Description	Info - Log Erased
[ENTER] Select [ESC] Back [F5] Refresh [F8] Save [F10] Exit	

9.3.9.1.2 Home > Logs > Base Modem > Stored Statistic Table



An Eb No value of 99.9 dB means “signal loss.”

```
CDM-625/A: Home > Logs > Base Modem > Stored Statistic Table
```

<Statistic 1>	
Statistic Date	28/06/13
Statistic Time	12:35:57
Statistic Min Eb No	99.9 dB
Statistic Avg Eb No	99.9 dB
Statistic Max Tx Power Increase	0.0 dB
Statistic Avg Tx Power Increase	0.0 dB
Statistic Min Reed-Solomon L	396 dB
Statistic Avg Reed-Solomon L	396 dB

```
[ENTER] Select [ESC] Back [F5] Refresh [F8] Save [F10] Exit
```

Open the scrollable Stored Statistic Table from the Base Modem page. Use the $\uparrow\downarrow$ arrow keys to scroll through the available entries. The date, time, and description are provided for each statistic. Statistics are numbered in the order logged, from the time the statistics logging buffer was last cleared.

Press **[ESC]** to return to the Base Modem page. Or, you may press **[ENTER]** to select and view in a standalone window, a specific stored statistic as shown in this example:

```
CDM-625/A: Home > Logs > Base Modem > Stored Statistic Table > Statistic 1
```

Statistic 1	
Statistic Date	28/06/13
Statistic Time	12:55:57
Statistic Min Eb No	99.9 dB
Statistic Avg Eb No	99.9 dB
Statistic Max Tx Power Increase	0.0 dB
Statistic Avg Tx Power Increase	0.0 dB
Statistic Min Reed-Solomon L	396 dB
Statistic Avg Reed-Solomon L	396 dB

```
[ENTER] Select [ESC] Back [F5] Refresh [F8] Save [F10] Exit
```

9.3.9.2 Home > Logs > Packet Processor

```

CDM-625/A: Home > Logs > Packet Processor

[A] Stored Event Table
[B] Logging [ Enable ]
[C] Logging Level [ All Information ]
[D] Clear Event Log [ Cancel ]

[ENTER] Select [ESC] Back [F5] Refresh [F8] Save [F10] Exit
    
```

Open the Packet Processor page from the Logs submenu. This page contains the following options:

Hot Key	Page / Dialog Window	Description / Option Entry
A	Stored Event Table	See Sect. 9.3.9.2.1
B	Logging	Use the ↑↓ arrow keys to select Enable or Disable
C	Logging Level	Use the ↑↓ arrow keys to select Errors Only , Errors And Warnings , or All Information
D	Clear Event Log	Use the ↑↓ arrow keys to select Cancel or Clear

Press a hot key to open a dialog window. See the specified chapter section for further information. Otherwise, press **[ESC]** to return to the Logs submenu.

9.3.9.2.1 Home > Logs > Packet Processor > Stored Event Table

CDM-625/A: Home > Logs > Packet Processor > Stored Event Table	
<Event 1>	
Event Log Type	Informational
Event Log Date	04/29/2013
Event Log Time	13:57:02
Event Log Description	Event log cleared.
[ENTER]Select [ESC]Back [F5]Refresh [F8]Save [F10]Exit	

Open the scrollable Stored Event Table from the Packet Processor page. Use the $\uparrow\downarrow$ arrow keys to scroll through the available entries. You may also select a header (e.g., <Event 1>) and press **[ENTER]** to select, and then view in a standalone window, a specific stored event as shown in this example:

CDM-625/A: Home > Logs > Packet Processor > Stored Event Table > Event 1	
Event Log Type	Informational
Event Log Date	04/29/2013
Event Log Time	13:57:02
Event Log Description	Event log cleared.
[ENTER]Select [ESC]Back [F5]Refresh [F8]Save [F10]Exit	

The date, time, and description are provided for each event. Events are numbered in the order logged, from the time the event logging buffer was last cleared.

Press **[ESC]** to return to the Base Modem page.

9.3.10 Home > Statistics Submenu

The Telnet CLI Statistics submenu provides access to a number of read-only informational pages. Most page submenus provide a dialog window that affords you the option to reset (clear) the counters for that specific page.

```

CDM-625/A: Home > Statistics

[A] Ethernet
[B] Router
[C] Managed Switch
[D] WAN (Router mode)
[E] WAN (Managed Switch Mode)
[F] Compression
[G] QoS
[H] PTP
[I] CPU
[J] Reset Counters

[ENTER] Select [ESC] Back [F5] Refresh [F10] Exit
    
```

Open the Statistics submenu from the Home menu:

Hot Key	Page	Description	Sect.
A	Ethernet	Access pages to review Ethernet Ports 1 through 4 Rx, Tx, and Error Statistics	9.3.10.1
B	Router	Review received, routed, transmitted, and errored packets	9.3.10.2
C	Managed Switch	Review Managed Switch LAN/WAN/Management received, transmitted, and errored packets statistics	9.3.10.3
D	WAN (Router Mode)	Review Router Mode WAN/Interface/Satellite received, transmitted, and errored packets and counters statistics	9.3.10.4
E	WAN (Managed Switch Mode)	Review Managed Switch Mode WAN/Interface/Satellite received, transmitted, and errored packets and counters statistics	9.3.10.5
F	Compression	Review payload and header compression statistics	9.3.10.6
G	QoS	Review Quality of Service statistics	9.3.10.7
H	PTP	Access pages to review LAN/WAN/PTP Engine statistics	9.3.10.8
I	CPU	Review CPU total, kernel and apps usage statistics	9.3.10.9
J	Reset Counters	Clear and reset all counters	9.3.10.10

Press a hot key to access a nested statistics page submenu. See the specified chapter section for further information. Otherwise, press **[ESC]** to return to the Home menu.

9.3.10.1 Home > Statistics > Ethernet Submenu

```
CDM-625/A: Home > Statistics > Ethernet

[A] Rx Statistics
[B] Tx Statistics
[C] Error Statistics
[D] Clear IP Statistics           [ Cancel ]

[ENTER]Select [ESC]Back [F5]Refresh [F8]Save [F10]Exit
```

Open the nested Ethernet submenu from the Statistics submenu:

Hot Key	Page / Dialog Window	Description / Option Entry
A	Rx Statistics	See Sect. 9.3.10.1.1
B	Tx Statistics	See Sect. 9.3.10.1.2
C	Error Statistics	See Sect. 9.3.10.1.2
D	Clear IP Statistics	Use the ↑↓ arrow keys to select Cancel or Clear

Press a hot key to open a statistics page or dialog window. See the specified chapter section for further information. Otherwise, press **[ESC]** to return to the nested Ethernet submenu.

9.3.10.1.1 Home > Statistics > Ethernet > Rx

```
CDM-625/A: Home > Statistics > Ethernet > Rx

<Port 1>
Enet Total Pkts Received          6173
Enet Rx Unicast Pkts              5662
Enet Rx Broadcast Pkts            221
Enet Rx Multicast Pkts            290
Enet Rx Pause Frames              0
Enet Bytes Received               420858
Enet Total Receive Errors         0
Enet Rx Current Datarate          0 kbps
Enet Rx Avg Datarate              0 kbps
Enet Rx Max Data Rate             238 kbps
Enet Rx Current Pkt Rate          0
Enet Rx Avg Pkt Rate              0
Enet Rx Max Pkt Rate              465

<Port 6>
Enet Total Pkts Received          65
Enet Rx Unicast Pkts              65
Enet Rx Broadcast Pkts            0
Enet Rx Multicast Pkts            0
Enet Rx Pause Frames              0
Enet Bytes Received               20673
Enet Total Receive Errors         0
Enet Rx Current Datarate          0 kbps
Enet Rx Avg Datarate              0 kbps
Enet Rx Max Data Rate             21 kbps
Enet Rx Current Pkt Rate          0
Enet Rx Avg Pkt Rate              0
Enet Rx Max Pkt Rate              7

[ENTER]Select [ESC]Back [F5]Refresh [F8]Save [F10]Exit
```

Open the scrollable Rx statistics page from the nested Ethernet submenu. Use the $\uparrow\downarrow$ arrow keys to scroll through the available entries. You may also select a header (e.g., <Port 1>) and press **[ENTER]** to view, in a standalone window, a specific set of statistics as shown in this example:

```
CDM-625/A: Home > Statistics > Ethernet > Rx > Port 1

Enet Total Pkts Received          8169
Enet Rx Unicast Pkts              7623
Enet Rx Broadcast Pkts            236
Enet Rx Multicast Pkts            310
Enet Rx Pause Frames              0
Enet Bytes Received               549969
Enet Total Receive Errors         0
Enet Rx Current Datarate          21 kbps
Enet Rx Avg Datarate              1 kbps
Enet Rx Max Data Rate             238 kbps
Enet Rx Current Pkt Rate          41
Enet Rx Avg Pkt Rate              2
Enet Rx Max Pkt Rate              465

[ENTER]Select [ESC]Back [F5]Refresh [F8]Save [F10]Exit
```

Press **[ESC]** to return to the nested Ethernet submenu.

9.3.10.1.2 Home > Statistics > Ethernet > Tx

```
CDM-625/A: Home > Statistics > Ethernet > Tx

<Port 1>
Enet Total Pkts Transmitted      15044
Enet Tx Unicast Pkts             14975
Enet Tx Broadcast Pkts           3
Enet Tx Multicast Pkts           66
Enet Tx Pause Frames             0
Enet Bytes Transmitted           1281902
Enet Tx Current Datarate         14 kbps
Enet Tx Avg Datarate             0 kbps
Enet Tx Max Data Rate            633 kbps
Enet Tx Current Pkt Rate         22
Enet Tx Avg Pkt Rate             0
Enet Tx Max Pkt Rate             924

<Port 6>
Enet Total Pkts Transmitted      188
Enet Tx Unicast Pkts             83
Enet Tx Broadcast Pkts           39
Enet Tx Multicast Pkts           66
Enet Tx Pause Frames             0
Enet Bytes Transmitted           32814
Enet Tx Current Datarate         0 kbps
Enet Tx Avg Datarate             0 kbps
Enet Tx Max Data Rate            21 kbps
Enet Tx Current Pkt Rate         1
Enet Tx Avg Pkt Rate             0
Enet Tx Max Pkt Rate             8

[ENTER]Select [ESC]Back [F5]Refresh [F8]Save [F10]Exit
```

Open the scrollable Tx statistics page from the nested Ethernet submenu. Use the **↑↓** arrow keys to scroll through the available entries. You may also select a header (e.g., <Port 1>) and press **[ENTER]** to view, in a standalone window, a specific set of statistics as shown in this example:

```
CDM-625/A: Home > Statistics > Ethernet > Tx > Port 1

Enet Total Pkts Transmitted      22844
Enet Tx Unicast Pkts             22771
Enet Tx Broadcast Pkts           3
Enet Tx Multicast Pkts           70
Enet Tx Pause Frames             0
Enet Bytes Transmitted           1956410
Enet Tx Current Datarate         399 kbps
Enet Tx Avg Datarate             4 kbps
Enet Tx Max Data Rate            633 kbps
Enet Tx Current Pkt Rate         571
Enet Tx Avg Pkt Rate             6
Enet Tx Max Pkt Rate             924

[ENTER]Select [ESC]Back [F5]Refresh [F8]Save [F10]Exit
```

Press **[ESC]** to return to the nested Ethernet submenu.

9.3.10.1.3 Home > Statistics > Ethernet > Errors

```
CDM-625/A: Home > Statistics > Ethernet > Errors

<Port 1>
Enet Rx FCS Err          0
Enet Rx Alignment Err    0
Enet Rx Undersize        0
Enet Rx Fragments        0
Enet Rx Jabber           0
Enet Rx Oversize         0
Enet Rx Discards         0
Enet Tx Single Collision  0
Enet Tx Multiple Collisions 0
Enet Tx Excessive Collisions 0

<Port 6>
Enet Rx FCS Err          0
Enet Rx Alignment Err    0
Enet Rx Undersize        0
Enet Rx Fragments        0
Enet Rx Jabber           0
Enet Rx Oversize         0
Enet Rx Discards         0
Enet Tx Single Collision  0
Enet Tx Multiple Collisions 0
Enet Tx Excessive Collisions 0

[ENTER]Select [ESC]Back [F5]Refresh [F8]Save [F10]Exit
```

Open the scrollable Error statistics page from the nested Ethernet submenu. Use the **↑↓** arrow keys to scroll through the available entries. You may also select a header (e.g., <Port 1>) and press **[ENTER]** to view, in a standalone window, a specific set of statistics as shown in this example:

```
CDM-625/A: Home > Statistics > Ethernet > Errors > Port 1

Enet Rx FCS Err          0
Enet Rx Alignment Err    0
Enet Rx Undersize        0
Enet Rx Fragments        0
Enet Rx Jabber           0
Enet Rx Oversize         0
Enet Rx Discards         0
Enet Tx Single Collision  0
Enet Tx Multiple Collisions 0
Enet Tx Excessive Collisions 0

[ENTER]Select [ESC]Back [F5]Refresh [F8]Save [F10]Exit
```

Press **[ESC]** to return to the nested Ethernet submenu.

9.3.10.2 Home > Statistics > Router

```

CDM-625/A: Home > Statistics > Router

[A] Router Clear Stats          [ Cancel ]
Router Received Pkts           0 packets
Router Routed Pkts             0 packets
Router Error IP Header         0
Router Error IP Dest           95
Router Error No Route          0
Router Error Buffer Full        0
Management Received Pkts      13328 packets
Management Transmitted Pkts   27036 packets

[ENTER] Select [ESC] Back [F5] Refresh [F8] Save [F10] Exit
  
```

Open the Router statistics page from the Statistics submenu:

Hot Key	Dialog Window	Option Entry
A	Router Clear Stats	Use the ↑↓ arrow keys to select Cancel or Clear

Press the hot key to open the dialog window. Otherwise, press **[ESC]** to return to the Statistics submenu.

9.3.10.3 Home > Statistics > Managed Switch

```

CDM-625/A: Home > Statistics > Managed Switch

[A] Clear Stats                               [ Cancel ]

LAN
Interface Received Pkts LAN                   14649 packets
Interface Transmitted Pkts LAN                26768 packets

WAN
Interface Received Pkts WAN                   0 packets
Interface Transmitted Pkts WAN                893 packets

Management
Management Received Pkts                     26768 packets
Management Transmitted Pkts                  13867 packets
WAN Rx Errors                                0
WAN Tx Errors                                0

[ENTER] Select [ESC] Back [F5] Refresh [F8] Save [F10] Exit
  
```

Open the Managed Switch statistics page from the Statistics submenu:

Hot Key	Dialog Window	Option Entry
A	Router Clear Stats	Use the ↑↓ arrow keys to select Cancel or Clear

Press the hot key to open the dialog window. Otherwise, press **[ESC]** to return to the Statistics submenu.

9.3.10.4 Home > Statistics > WAN (Router Mode)

```
CDM-625/A: Home > Statistics > WAN (Router Mode)

Interface Transmitted Pkts WAN          packets
Tx WAN Utilization                      0 percent

Counters
Interface Transmitted Pkts WAN          1 packets
Satellite Tx Frames                     45 packets
Interface Received Pkts WAN            0 packets
Satellite Rx Frames                     0 packets

Errors
WAN Tx Errors                           0
Satellite Tx Errors                     0
WAN Rx Errors                           0
Satellite Rx Errors                     0

Detailed Satellite Rx Errors
Satellite Rx Frame CRC Errors           0
Satellite Rx Oversized Errors           0
Satellite Rx Undersized Errors           0
Satellite Rx Frame Length Errors         0
Satellite Rx Overrun Errors              0

[ENTER]Select [ESC]Back [F5]Refresh [F8]Save [F10]Exit
```

Open the scrollable WAN (Router Mode) statistics page from the Statistics submenu. Otherwise, press **[ESC]** to return to the Statistics submenu.

9.3.10.5 Home > Statistics > WAN (Managed Switch Mode)

```

CDM-625/A: Home > Statistics > WAN (Managed Switch Mode)

[A] Clear Stats                                [ Cancel ]

Tx WAN Utilization                            0 percent
Counters
Interface Transmitted Pkts WAN                943 packets
Satellite Tx Frames                          45 packets
Interface Received Pkts WAN                  0 packets
Satellite Rx Frames                          0 packets

Errors
WAN Tx Errors                                0
Satellite Tx Errors                          0
WAN Rx Errors                                0
Satellite Rx Errors                          0

Detailed Satellite Rx Errors
Satellite Rx Frame CRC Errors                0
Satellite Rx Oversized Errors                0
Satellite Rx Undersized Errors               0
Satellite Rx Frame Length Errors            0
Satellite Rx Overrun Errors                  0

[ENTER]Select [ESC]Back [F5]Refresh [F8]Save [F10]Exit
  
```

Open the scrollable WAN (Managed Switch Mode) statistics page from the Statistics submenu:

Hot Key	Dialog Window	Option Entry
A	Clear Stats	Use the ↑↓ arrow keys to select Cancel or Clear

Press the hot key to open the dialog window. Otherwise, press **[ESC]** to return to the Statistics submenu.

9.3.10.6 Home > Statistics > Compression

```

CDM-625/A: Home > Statistics > Compression

[A] Compression Clear Counters          [ Cancel ]
[B] View Statistics Table

General Compression Statistics
Pre Payload Compression Bytes          4052 bytes
Post Payload Compression Bytes         0 bytes
Payload Compression Savings            0 percent saved
Payload Compression Ratio              100 one hundredths

[ENTER]Select [ESC]Back [F5]Refresh [F8]Save [F10]Exit
    
```

Open the Compression statistics page from the Statistics submenu:

Hot Key	Page / Dialog Window	Option Entry / Description
A	Compression Clear Counters	Use the ↑↓ arrow keys to select Cancel or Clear
B	View Statistics Table	See Sect. 9.3.10.6.1

Press a hot key to open the dialog window or view the statistics table. Otherwise, press **[ESC]** to return to the Statistics submenu.

9.3.10.6.1 Home > Statistics > Compression > Table View

```
CDM-625/A: Home > Statistics > Compression > Table View

<Route Index 1>
Pre Header Comp Bytes           0 bytes
Post Header Comp Bytes          0 bytes
Header Comp Savings              0 percent saved
Header Comp Total Packets        0 packets
Header Comp Full Header Packets  0 packets
Header Comp Error Packets        0 packets

[ENTER]Select [ESC]Back [F5]Refresh [F10]Exit
```

Open the scrollable Compression statistics table from the nested Compression submenu.

Use the **↑↓** arrow keys to scroll through the available entries. You may also select a header (e.g., <Route Index 1>) and press **[ENTER]** to view, in a standalone window, a specific set of statistics as shown in this example:

```
CDM-625/A: Home > Statistics > Compression > Table View > Route Index 1

Pre Header Comp Bytes           0 bytes
Post Header Comp Bytes          0 bytes
Header Comp Savings              0 percent saved
Header Comp Total Packets        0 packets
Header Comp Full Header Packets  0 packets
Header Comp Error Packets        0 packets

[ENTER]Select [ESC]Back [F5]Refresh [F10]Exit
```

Press **[ESC]** to return to the Compression page.

9.3.10.7 Home > Statistics > QoS

```

CDM-625/A: Home > Statistics > QoS
[A] QoS Clear Counters          [ Cancel ]
[B] View Statistics Table

[ENTER]Select [ESC]Back [F5]Refresh [F10]Exit
    
```

Open the QoS statistics page from the Statistics submenu:

Hot Key	Page / Dialog Window	Option Entry / Description
A	QoS Clear Counters	Use the ↑↓ arrow keys to select Cancel or Clear
B	View Statistics Table	See Sect. 9.3.10.7.1

Press a hot key to open the dialog window or view the table. Otherwise, press **[ESC]** to return to the Statistics submenu.

9.3.10.7.1 Home > Statistics > QoS > Table View

```

CDM-625/A: Home > Statistics > QoS > Table View
<QoS Index 1>
QoS Stats Description          ALL
QoS Stats Tx Packets           75 packets
QoS Stats Dropped Packets     1175 packets
QoS Stats Tx Packet Rate       0 packets / second
QoS Stats Tx Data Rate         0 Kbps

[ENTER]Select [ESC]Back [F5]Refresh [F10]Exit
    
```

Open the scrollable QoS statistics table from the nested QoS submenu.

Use the ↑↓ arrow keys to scroll through the available entries. You may also select a header (e.g., <QoS Index 1>) and press **[ENTER]** to view, in a standalone window, a specific set of statistics as shown in this example:

```

CDM-625/A: Home > Statistics > QoS > Table View > QoS Index 1
QoS Stats Description          ALL
QoS Stats Tx Packets           75 packets
QoS Stats Dropped Packets     1187 packets
QoS Stats Tx Packet Rate       0 packets / second
QoS Stats Tx Data Rate         0 Kbps

[ENTER]Select [ESC]Back [F5]Refresh [F10]Exit
    
```

Press **[ESC]** to return to the Compression page.

9.3.10.8 Home > Statistics > PTP

```
CDM-625/A: Home > Statistics > PTP

[A] LAN Details
[B] WAN Details

PTP Engine Status           Stopped
PTP Time                    2013-07-25 15:30:25.937
PTP Offset                  0.000000000
PTP LAN State               Disabled
PTP WAN State               Disabled

[ENTER] Select [ESC] Back [F5] Refresh [F10] Exit
```

Open the PTP statistics page from the Statistics submenu:

Hot Key	Page	Description
A	LAN Details	See Sect. 9.3.10.8.1
B	WAN Details	See Sect. 9.3.10.8.2

Press a hot key to view a statistics page. Otherwise, press [ESC] to return to the Statistics submenu.

9.3.10.8.1 Home > Statistics > PTP > LAN Details

CDM-625/A: Home > Statistics > PTP > LAN Details	
PTP LAN Event Port Received	0
PTP LAN Event Port Transmitted	0
PTP LAN General Port Received	0
PTP LAN General Port Transmitted	0
PTP LAN Announce Received	0
PTP LAN Announce Transmitted	0
PTP LAN Sync Received	0
PTP LAN Sync Transmitted	0
PTP LAN Followup Received	0
PTP LAN Followup Transmitted	0
PTP LAN Delay Request Received	0
PTP LAN Delay Request Transmitted	0
PTP LAN Delay Response Received	0
PTP LAN Delay Response Transmitted	0
PTP LAN Management Received	0
PTP LAN Management Transmitted	0
PTP LAN Signal Received	0
PTP LAN Signal Transmitted	0
PTP LAN Discarded Received	0
PTP LAN Discarded Transmitted	0

[ENTER] Select [ESC] Back [F5] Refresh [F10] Exit

Open the LAN Details statistics page from the PTP page. Otherwise, press **[ESC]** to return to the PTP page.

9.3.10.8.2 Home > Statistics > PTP > WAN Details

CDM-625/A: Home > Statistics > PTP > WAN Details	
PTP WAN Event Port Received	0
PTP WAN Event Port Transmitted	0
PTP WAN General Port Received	0
PTP WAN General Port Transmitted	0
PTP WAN Announce Received	0
PTP WAN Announce Transmitted	0
PTP WAN Sync Received	0
PTP WAN Sync Transmitted	0
PTP WAN Followup Received	0
PTP WAN Followup Transmitted	0
PTP WAN Delay Request Received	0
PTP WAN Delay Request Transmitted	0
PTP WAN Delay Response Received	0
PTP WAN Delay Response Transmitted	0
PTP WAN Management Received	0
PTP WAN Management Transmitted	0
PTP WAN Signal Received	0
PTP WAN Signal Transmitted	0
PTP WAN Discarded Received	0
PTP WAN Discarded Transmitted	0

[ENTER] Select [ESC] Back [F5] Refresh [F10] Exit

Open the WAN Details statistics page from the PTP page. Otherwise, press **[ESC]** to return to the PTP page.

9.3.10.9 Home > Statistics > CPU

CDM-625/A: Home > Statistics > CPU Statistics	
CPU Usage Total	1
CPU Usage Kernel	0
CPU Usage Apps	1
[ENTER] Select [ESC] Back [F5] Refresh [F10] Exit	

Open the CPU statistics page from the Statistics submenu. Otherwise, press **[ESC]** to return to the Statistics submenu.

9.3.10.10 Home > Statistics > Clear All Counters

CDM-625/A: Home > Statistics > Clear Counters	
[A] Clear All Counters	[Cancel]
[ENTER] Select [ESC] Back [F5] Refresh [F8] Save [F10] Exit	

Open the Clear All Counters page from the Statistics submenu:

Hot Key	Dialog Window	Option Entry
A	Clear All Counters	Use the ↑↓ arrow keys to select Cancel or Clear

Press the hot key to open the dialog window. Otherwise, press **[ESC]** to return to the Statistics submenu.

9.3.11 Home > Contact Page

For all product support, please call:

+1.240.243.1880

+1.866.472.3963 (toll free USA)

Chapter 10. CDM-625A ODU (TRANSCEIVER, BUC, LNB) OPERATION

10.1 Overview

The CDM-625A Advanced Satellite Modem permits configuration, monitoring, and control of Comtech EF Data ODUs (Outdoor Units) either in standalone or 1:1 redundant configuration.

The following ODUs are compatible under 70/140 MHz operation:

- **CSAT-5060** series (5 to 25, 50 & 100 Watts) C-Band Transceivers
- **KST-2000A** (LNA) Ku-Band Satellite Transceiver
- **KST-2000B** (LNB) Ku-Band Satellite Transceiver

Under L-Band operation, ODU refers to use of a **Comtech EF Data LPOD Outdoor Amplifier / Block Up Converter (BUC)**, or an **LNB (Low-Noise Block Down Converter)**.

For either 70/140 MHz or L-Band operation, you may fully monitor and control ODU operations in the following ways:

- By using the CDM-625A front panel keypad and VFD. The Front Panel ODU menu branch allows you to configure power supplies, a 10 MHz reference, and low/high current alarm thresholds for the BUC and LNB.

LO (Local Oscillator) menus allow you to set up the upconversion and downconversion settings for the BUC and LNB so that you can view the satellite frequencies as well as the modem IF input/output frequencies.

- By using ODU remote commands through Serial-based Remote Product Management with the **CSAT-5060** or **KST-2000A/B Transceiver**, or the **LPOD**.
- By using the SNMP Interface with the **CSAT-5060** or **KST-2000A/B Transceiver MIB**.

- By using the CDM-625A HTTP (Web Server) Interface (excluding the **LPOD**).
- By using the CDM-625A Telnet Command Line Interface for **CSAT-5060 Transceiver** operation (excluding the **KST-2000A/B Transceiver** or the **LPOD**).

10.2 ODU Remote Control Address Setup

The ODU, as connected to a CDM-625A through FSK (Frequency Shift Keying), can be remotely monitored and controlled through the use of ODU commands and queries issued via serial remote control or with the Telnet Command Line Interface (CLI).

The address of the ODU is set up as follows:

- **For Local-End ODUs:**
 - Use the Modem's RC Address + 1 for a Standalone Unit or the Online Unit in a 1:1 Redundancy System;
 - Use the Modem's RC Address + 2 for the Offline Unit in a 1:1 Redundancy System.
- **For Distant-End ODUs in an EDMAC setup:**
 - Use the EDMAC Slave Address (ESA) Range +4 for Standalone Unit or the Online Unit in a 1:1 Redundancy System;
 - Use the EDMAC Slave Address (ESA) Range +5 for the Offline Unit in a 1:1 Redundancy System.



- **Chapter 8. SERIAL-BASED REMOTE PRODUCT MANAGEMENT**
- **Appendix H. EDMAC CHANNEL**

10.3 ODU Operations via the CDM-625A Front Panel



- 1) The ODU menu branch is accessible from the CDM-625A front panel menu only when the CDM-625A detects the presence of an installed ODU.
- 2) This chapter deals strictly with ODU operations. Chapter 6. FRONT PANEL OPERATION provides detailed information for any CDM-625A menu operations or selections not otherwise specified here.

10.3.1 CDM-625A Front Panel Operation Overview



See Chapter 6. FRONT PANEL OPERATION for an in-depth explanation of the function and operation of the CDM-625A front panel.

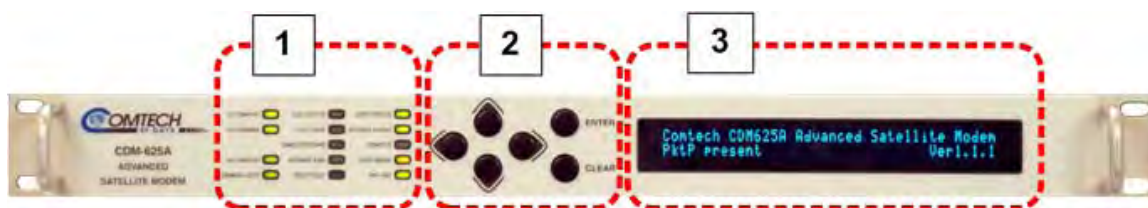

Feature	Description	Function	See Chapter Section...
1	LED Indicators	The LEDs indicate, in a summary fashion, the status of the modem.	6.1.1
2	Keypad	The keypad comprises six individual keyswitches. The keys have a positive 'click' action that provides tactile feedback. Enter data via the keypad. Data, prompts, and messages are displayed on the VFD.	6.1.2
3	Vacuum Fluorescent Display (VFD)	The VFD is an active display showing two lines of 40 characters each. It produces a blue light with adjustable brightness. Nested menus display all available options and prompt you to carry out a required action.	6.1.3

Figure 10-1. CDM-625A Front Panel Features

Use the CDM-625A front panel keypad and Vacuum Fluorescent Display (**Figure 10-1**) to configure, monitor, and control ODU operation. Nested menus display all available options and prompt you to carry out any required action(s) (**Figure 10-2**).

10.3.2 CDM-625A Front Panel Menus – ODU Menu Hierarchy

Figure 10-2 identifies the CDM-625A front panel menu hierarchies allocated to the configuration, monitor, and control of a Comtech EF Data ODU. More specifically, menu branches that incorporate ODU operations are shown in **bold**; menu content that is dedicated to ODU operations is additionally **italicized**.

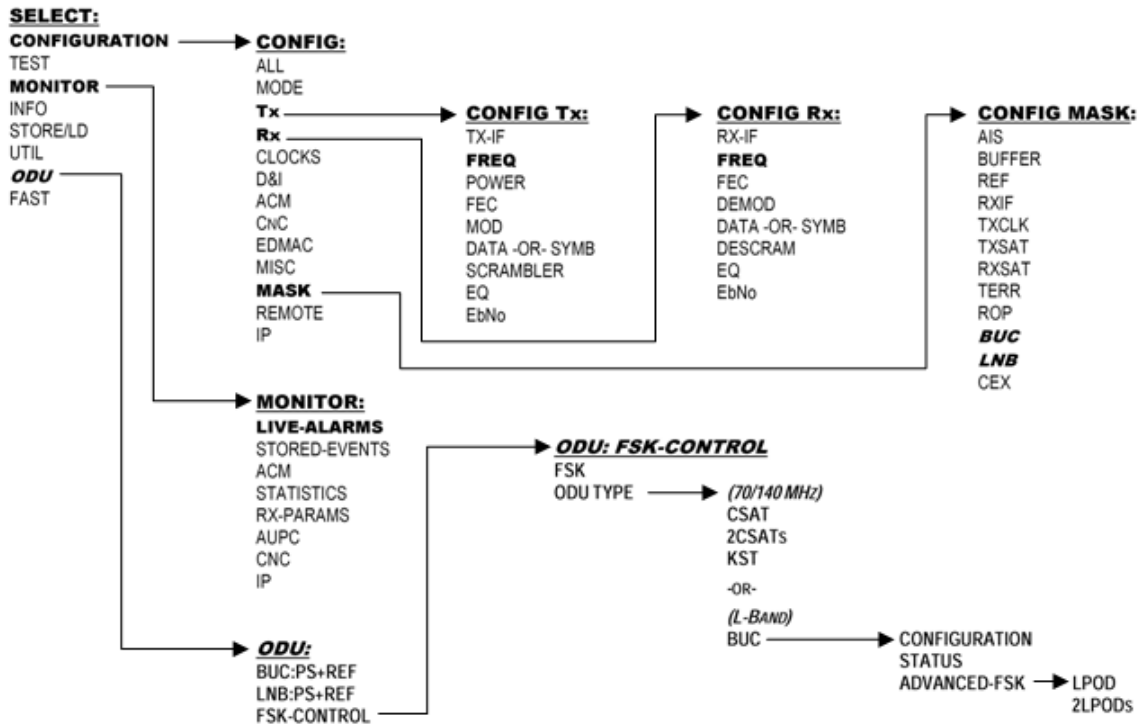

Figure 10-2.CDM-625A Front Panel ODU Operation Menu Tree – (FW Ver. 1.4.1)

10.3.3 SELECT: (Main) Menu Overview

```
SELECT: Configuration Test Monitor
Info Store/Ld Utility ODU FAST (◀ ▶)
```

Press **ENTER** or **CLEAR** to immediately access the **SELECT:** menu screen from the opening screen. From any nested menu, press **CLEAR** repeatedly until this screen reappears.

The table that follows identifies each menu branch available from the **SELECT:** menu and its content section in **Chapter 6. FRONT PANEL OPERATION**. ODU M&C is available for selection as noted:

Menu Branch	See Chapter Section...	Function
Configuration	6.2.1	Use to fully configure the modem and the ODU alarm masks. The Tx, Rx, and Mask submenus incorporate ODU functionality. For detailed information see the following sections in this chapter: <ul style="list-style-type: none"> • 10.3.3.1.1 CONFIG: Tx →Freq and CONFIG: Rx →Freq • 10.3.3.1.2.1 CONFIG: Mask →BUC • 10.3.3.1.2.2 CONFIG: Mask→LNB
Test	6.2.2	Use to configure the modem into one of several Test modes, and configures/monitors the BER Tester.
Monitor	6.2.3	Use to monitor the current status of the modem and ODUs and view the log of stored events for the modem. For detailed information, see to Sect. 10.3.3.2 (SELECT: MONITOR) Live-Alarm Menus in this chapter.
Info	6.2.4	(Information) Use to view information on the modem without having to access the Configuration screens.
Store/Ld	6.2.5	(Store/Load) Use to store and retrieve up to 10 different modem configurations.
Utility	6.2.6	Use to perform miscellaneous functions – e.g., setting the Real-Time Clock, adjusting the VFD brightness, etc.
ODU	6.2.7 (Summary)	(Outdoor Unit) For detailed information, see Sect. 10.3.3.3 (SELECT: ODU) Menu Branches in this chapter.
FAST	6.2.8	(Fully Accessible System Topology) Use to configure available options – e.g., extended data rates, interfaces, etc. Contact Comtech EF Data Product Support for details.

From the top **SELECT:** menu, use the ◀▶ arrow keys to select **Configuration** or **ODU**, and then press **ENTER**.

10.3.3.1 (SELECT: CONFIGURATION) Menu Branches

```
CONFIG: All Mode Tx Rx Clocks D&I/ACM  
CnC EDMAC Misc Mask Remote IP (◀ ▶)
```

Use the ◀▶ arrow keys to select **Tx**, **Rx**, or **Mask**, and then press **ENTER**.

10.3.3.1.1 CONFIG: Tx → Freq and CONFIG: Rx → Freq Submenus

```
Tx-IF Frequency: 1750.0000 MHz  
(LO:12500 MHz Sat:14250.0000 MHz) (◀ ▶ ⬆)
```

```
Rx-IF Frequency: 1200.0000 MHz  
(LO:12500 MHz Sat:13700.0000 MHz) (◀ ▶ ⬆)
```

When you use the ODU menus to configure a BUC or LNB LO-frequency, the **CONFIG: Tx→Freq** and **CONFIG: Rx→Freq** menu screens provide supplemental information on the bottom line. As you edit the IF frequency, the Satellite frequency updates accordingly.



Satellite frequency = LO ± IF frequency, where the ± sign is determined by the LO mix setting:

- High-sided mix [-] (includes a spectral inversion);
- Low-sided mix [+].

To edit the Tx-IF or Rx Frequency, use the ◀▶ arrow keys to select a digit to edit, and then use the ▲▼ arrow keys to change that digit. The available ranges are 50-180 MHz, and 950-2000 MHz (L-Band) (**FAST option**). The resolution is 100Hz. Press **ENTER** when done.

10.3.3.1.2 (SELECT: CONFIGURATION) Mask Submenus

The Mask submenus allow you to selectively mask (ignore) or make active various alarms and traffic conditions that are monitored by the modem.

```
Alarm Masks: AIS Buffer Ref RxIF TxClk  
TxSat RxSat Terr ROP BUC LNB CEX (◀ ▶)
```

Use the ◀▶ arrow keys to select **BUC** or **LNB**, and then press **ENTER**.

10.3.3.1.2.1 CONFIG: Mask → BUC

```
BUC alarm = Active          (Active,Mask)
Attach to Tx alarm = No    (Yes,No) (▲ ▼◆)
```

When using L-Band, a Block Up Converter (BUC) may be included in the system. A 'smart' BUC may be monitored and/or controlled via the modem via FSK (Frequency-Shift Keying control).



For a modem in a 1:1 redundancy setup, the fault indications must be customized for the physical setup:

- 1) **Two modems, two LNBS in parallel** – If a fault occurs on the active modem/BUC pair and switchover is desired, the BUC mask should be configured as **Attach to Tx alarm = Yes**.
- 2) The more common redundancy setup is **Two modems in parallel, one BUC** – If a fault occurs on the active modem, switchover is desired. But, if a fault occurs on the BUC yet a switchover of modems does *not* fix the problem, then switchover should *not* occur and the BUC mask should be configured as **Attach to Tx alarm = No**.

If the system has no redundancy and was attached to an external audio alarm, **Attach to Tx alarm = Yes** would indicate that a BUC fault has occurred, as the fault would be included in the FORM C alarms.

First, use the ▲ ▼ arrow keys to select **BUC Alarm** or **Attach to Tx alarm**. Then:

- For **BUC Alarm**, use the ▲ ▼ arrow keys to select **Active** or **Masked**.
- For **Attach to Tx alarm**, use the ▲ ▼ arrow keys to select **Yes** or **No**.

Press **ENTER** when done.

10.3.3.1.2.2 CONFIG: Mask → LNB

```
LNB alarm = Active          (Active,Mask)
Attach to Rx alarm = No    (Yes,No) (◀ ▶ ⏏)
```

When using L-Band, a Low-Noise Block Down Converter (LNB) may be included in the system. It cannot be monitored and/or controlled by the modem, except for the power supply values.



For a modem in a 1:1 redundancy setup, the fault indications must be customized for the physical setup:

- 1) **Two modems, two LNBs in parallel** – If a fault occurs on the active modem/LNB pair and switchover is desired, the LNB mask should be configured as Attach to Rx alarm = Yes.
- 2) The more common redundancy setup is **Two modems in parallel, one LNB** – If a fault occurs on the active modem, switchover is desired. But, if a fault occurs on the LNB, a switchover of modems might or might *not* fix the problem. If switchover should take place, the LNB mask should be configured as **Attach to Rx alarm = Yes**.

If the system has no redundancy and was attached to an external audio alarm, **Attach to Rx alarm = Yes** would indicate that a LNB fault has occurred, as the fault would be included in the FORM C alarms.

First, use the ◀▶ arrow keys to select **LNB Alarm** or **Attach to Rx alarm**. Then:

- For **LNB Alarm**, use the ▲▼ arrow keys to select **Active** or **Masked**.
- For **Attach to Rx alarm**, use the ▲▼ arrow keys to select **Yes** or **No**.

Press **ENTER** when done.

10.3.3.2 (SELECT: MONITOR) Live-Alarms Menu

```

Live      Unit=None      Net=None
Alarms    Rx=Demod Lock  Tx=No Clock (⬆)
  
```

```

Live      BUC=None
Alarms    LNB=None      (⬆)
  
```

Six alarm types are provided across two screens. The last two alarm types (on the second screen) pertain to ODU operation as shown in the preceding examples.

Use the ▲▼ arrow keys to navigate between these **read-only** pages. The **highest** priority alarms currently active for each of the ODU alarm types are as follows:

ALARM TYPE	
BUC	BUC current
	BUC voltage
	BUC checksum or bad comms
	BUC PLL
	BUC temperature
LNB	LNB current
	LNB voltage

10.3.3.3 (SELECT:) ODU Menu Branches

```
ODU: BUC:PwrSupply+Ref
      LNB:PwrSupply+Ref  FSK-control (◀ ▶)
```

Use the ◀▶ arrow keys to select **BUC:PwrSupply+Ref**, **LNB:PwrSupply+Ref**, or **FSK-control**, and then press **ENTER**:

ODU Menu Branch	Sect.	Nested Menu Function
BUC:PwrSupply+Ref	10.3.3.3.1	Provides menus to enter a Tx LO frequency, and to control a 10MHz reference and for Power supply control and alarm limits.
LNB:PwrSupply+Ref	10.3.3.3.2	Provides menus to enter an Rx LO frequency, and to control a 10MHz reference and for Power supply control and alarm limits.
FSK-control	10.3.3.3.3	(Frequency Shift Keying control) Provides menus to monitor and control CSAT-5060 OR KST-2000A/B or BUC settings, and LPOD settings via Advanced FSK. The appearance of, and the functional selections available from this nested menu are dependent on the Tx frequency employed – 70/140 versus L-Band.

10.3.3.3.1 ODU: BUC:PwrSupply+Ref (Power Supply and Reference)

```
BUC control/monitor (non-FSK):
PSU-and-10MHz  LO-freq  PSUmonitor (◀ ▶)
```

The modem provides DC power and a 10MHz reference that may be used by a BUC. Use the ◀▶ arrow keys to select **PSU-and-10MHz**, **LO-Freq**, or **PSUmonitor**, and then press **ENTER**.

10.3.3.3.1.1 ODU: BUC:PwrSupply+Ref → PSU-and-10MHz Parameters

```
BUC supply=N/I      10MHz-ref:Off (Off,On)
Alarm limits, from 0.0 to 2.0 amps (◀ ▶⬇)
```

Use the ◀▶ arrow keys to select **BUC Supply**, **10MHz-ref**, or **Alarm Limits**, and then use the ▲▼ arrow keys to select a setting:

Selection	Setting
BUC supply	Indicates installation state, e.g., N/I == Not Installed.
10MHz-ref	Set the 10MHz Reference as Off or On .  A BUC will not transmit without a 10MHz reference.
Alarm Limits	Use the ◀▶ arrow keys to select a digit to edit, and then use the ▲▼ arrow keys to change that digit. Valid range, in Amps, is 0.0 to 4.0 .

Press **ENTER** when done.

10.3.3.3.1.2 ODU: BUC:PwrSupply+Ref → LO Freq (Local Oscillator Frequency)

```
BUC-LO Frequency= 00000 MHz  
Mix= High [-] (Hi,Lo) (◀ ▶ ◆)
```

Use the ◀▶ arrow keys to select **BUC-LO (Local Oscillator) Frequency** for the upconversion, or **Mix** to set the polarity for the upconversion mix in the BUC.

On the top line – To set the BUC-LO Frequency, use the ◀▶ arrow keys to select a digit to edit, and then use the ▲▼ arrow keys to change that digit. The valid LO range is **3000** to **65000** MHz. Entering a non-zero value for BUC LO causes the Tx-IF frequency menu to show LO and Satellite frequencies (**satellite frequency = LO frequency ± modem frequency**).

Press **ENTER** when done.

On the bottom line – To set the Mix polarity, use the ▲▼ arrow keys to set polarity as **Hi** (to indicate a high side, inverting mix) or **Lo** (to indicate a low side, non-inverting mix).

Press **ENTER** when done.

10.3.3.3.1.3 ODU: BUC:PwrSupply+Ref → PSUmonitor

```
BUC Power Supply:  
0000mA, 00.0V
```

Use this **read-only** display to view the power supply current and voltage information. Press **ENTER** or **CLEAR** to return to the previous menu.

10.3.3.3.2 ODU: LNB:PwrSupply+Ref (Power Supply and Reference)

```
LNB control/monitor:
PSU-and-10MHz  LO-freq  PSUmonitor  (◀ ▶)
```

The modem can supply DC power to an LNB connected to the Type 'N' rear panel Rx connector. It can also supply a 10 MHz reference for a phase-locked LNB. Use the ◀▶ arrow keys to select **PSU-and-10MHz**, **LO-freq**, or **PSUmonitor**, and then press **ENTER**.

10.3.3.3.2.1 ODU: LNB:PwrSupply+Ref → PSU-and-10MHz

```
LNB: Voltage=Off  10MHz:Off (Off,On)
Alarm limits, from 000 to 500 mA  (◀ ▶◆)
```

Use the ◀▶ arrow keys to select **Voltage**, **10MHz**, or **Alarm Limits**. Then, use the ▲▼ arrow keys to change that setting:

Selection	Setting
Voltage	Select Off , 13V , 18V , or 24V
10MHz	Set the 10MHz Reference as Off or On .
Alarm Limits	Use the ◀▶ arrow keys to select a digit to edit, and then use the ▲▼ arrow keys to change that digit. Valid range, in mA, is 000 to 500 .

Press **ENTER** when done.

10.3.3.3.2.2 ODU: LNB:PwrSupply+Ref → LO-Freq (Local Oscillator Frequency)

```
LNB-LO: Frequency= 00000 MHz
Mix= High [-] (Hi,Lo)  (◀ ▶◆)
```

Use the ◀▶ arrow keys to select the LNB-LO (Local Oscillator) **Frequency** for the downconversion, or **Mix** to set the polarity for the downconversion mix in the LNB.

On the top line – To set the LNB-LO Frequency, use the ◀▶ arrow keys to select a digit to edit, and then use the ▲▼ arrow keys to change that digit. The valid LO range is 3000 to 65000 MHz. Entering a non-zero value for LNB LO causes the Rx-IF frequency menu to show LO and Satellite frequencies (**satellite frequency = LO frequency ± modem frequency**).

Press **ENTER** when done.

On the bottom line – To set the Mix polarity, use the ▲▼ arrow keys to set polarity as **Hi** (to indicate a high side, inverting mix) or **Lo** (to indicate a low side, non-inverting mix).

Press **ENTER** when done.

10.3.3.3.2.3 ODU: LNB:PwrSupply+Ref → PSUmonitor

```
LNB Power Supply [Off]:  
0000mA, 00.0V
```

This **read-only** display shows the LNB power supply information. Press **ENTER** or **CLEAR** to return to the previous menu.

10.3.3.3.3 ODU: FSK-control

Comtech EF Data ODUs (CSAT, KST, or **LPOD**), when connected to a CDM-625A through Frequency Shift Keying (FSK), can be remotely monitored and controlled by using the CDM-625A front panel, Web Server interface, or by using remote commands and queries through Serial or Telnet Remote Product Management. In order to facilitate remote M&C, the ODU address is set up as follows:

- **For Local-End ODUs:**
 - Use the Modem's RC Address + 1 for a Standalone Unit or the Online Unit in a 1:1 Redundancy System;
 - Use the Modem's RC Address + 2 for the Offline Unit in a 1:1 Redundancy System.

- **For Distant-End ODUs in an EDMAC setup:**



- **Chapter 8. SERIAL-BASED REMOTE PRODUCT MANAGEMENT**
- **Appendix H. EDMAC CHANNEL**

- Use the EDMAC Slave Address (ESA) Range +4 for Standalone Unit or the Online Unit in a 1:1 Redundancy System;
- Use the EDMAC Slave Address (ESA) Range +5 for the Offline Unit in a 1:1 Redundancy System.

The appearance of the **ODU: FSK-control** screen adjusts automatically to the mode of operation: **70/140 MHz** or **L-Band**.

When the Tx frequency is 70/140 MHz – Communication with a Comtech EF Data CSAT or KST transceiver is achieved using a low-speed, half-duplex FSK link over the Rx IF port, with a carrier frequency around 2.7 MHz.

With FSK communication **disabled**, the **ODU: FSK-control** screen appears as shown here:

```
ODU Control:      FSK=Off    (Off,On)  
ODU Type: C/KST (C/KST, 2CSATS)  (◀ ▶ ◆)
```

To enable FSK, on the **top line** use the ◀▶ arrow keys to select **FSK**, and then use the ▲▼ arrow keys to set control as **On**.

Press **ENTER** when done.

Once FSK is **enabled**, the modem attempts to communicate with the installed transceiver(s). Once communications are established, the bottom line of the **ODU: FSK-control** screen updates to show the attached – and therefore controllable via FSK – transceiver(s), as per the following examples:

```
ODU Control:      FSK=Off      (Off,On)
ODU Type: CSAT (C/KST, 2CSATS)  (◀ ▶ ⬇)
```

```
ODU Control:      FSK=Off      (Off,On)
ODU Type: KST (C/KST, 2CSATS)  (◀ ▶ ⬇)
```

At this time, use the ◀▶ arrow keys to navigate to the **bottom line**, and then use the ▲▼ arrow keys to select (where appropriate), **CSAT**, **2CSATS**, or **KST**.

Press **ENTER** when done.



- Sect. 10.3.3.3.3.1 ODU: FSK-control → CSAT
- Sect. 0 ODU: FSK-control → 2CSATs (Redundant configuration)
- Sect. 10.3.3.3.3 ODU: FSK-control → KST

When the Tx frequency is L-Band – Communication with a ‘smart’ BUC is achieved using a low-speed, half-duplex FSK link over the Tx IF port, with a carrier frequency around 650 kHz.

With FSK communication **disabled**, the **ODU: FSK-control** screen appears as shown here:

```
ODU Control:      FSK=Off      (Off,On)
ODU Type: None    (due to Tx freq) (◀ ▶ ⬇)
```

Use the ◀▶ arrow keys to select **FSK** control, and then use the ▲▼ arrow keys to set control as **On**, and then press **ENTER**. Once FSK is **On**, the ODU type is fixed as “BUC” and the screen appears as shown here:

```
ODU Control:      FSK=On      (Off,On)
ODU Type: BUC     (due to Tx freq) (◀ ▶ ⬇)
```



- Sect. 10.3.3.3.3.4 ODU: FSK-control → BUC

10.3.3.3.1 ODU: FSK-control → CSAT



The CSAT menus that follow assume that you have already selected, and the system has identified, a (standalone) CSAT connected via the rear panel Rx IF port.

When the following menu selections are made:

- ODU: FSK-control → CSAT
- ODU: FSK-control → 2CSATs → CSAT#1
- ODU: FSK-control → 2CSATs → CSAT#2

You are directed to a common submenu branch:

```
CSAT-5060/050 V1.02
Configuration Monitor Alarms Info(◀ ▶)
```

For clarity, this common submenu branch and its nested menus are defined in this section. (CSAT#X denotes CSAT#1 or CSAT#2.)

Use the ◀▶ arrow keys to select **Configuration**, **Monitor**, **Alarms**, or **Info**, and then press **ENTER**.

10.3.3.3.1.1 ODU: FSK-control → CSAT (2CSATs → CSAT #X) → Configuration

```
Configuration settings:
Tx Rx LNA Misc (◀ ▶)
```

Use the ◀▶ arrow keys to select **Tx**, **Rx**, **LNA**, or **Misc**, and then press **ENTER**.

10.3.3.3.1.1.1 ODU: FSK-control → CSAT (2CSATs → CSAT #X) → Configuration → Tx

```
Tx: Fq=6247.0 MHz Att=23.00 dB Amp=On
Mute=Unmuted Slope: xxx, Cal (◀ ▶ ⬆ ⬇)
```

Use the ◀▶ arrow keys to select a setting, and then use the ▲▼ arrow keys to change that setting:

Selection	Setting
Fq	(Tx Frequency) 3625-4200 MHz, in steps of 1.0 or 2.5 MHz
At	(Tx Attenuation) 0 to 25 dB, in increments of .25dB
Amp	(Amplifier setting) Off or On

Selection	Setting
Mute	(Mute setting) Muted (i.e., Tx off) or Unmuted (i.e., Tx on)
Slope	Manual (0.0 to 1.0, in increments of 0.1) or Calibrated

Press **ENTER** to save, or **CLEAR** to cancel and return to the previous menu.

10.3.3.3.3.1.1.2 ODU: FSK-control → CSAT (2CSATs → CSAT #X) → Configuration → Rx

```
Rx: Fq=6427.0 MHz Att=23.00 dB
Mute=Unmuted Slope:x.x, Cal(◀▶⬇)
```

Use the ◀▶ arrow keys to select a setting, and then use the ▲▼ arrow keys to change that setting:

Selection	Setting
Fq	(Rx Frequency) 3625-4200 MHz, in steps of 1.0 or 2.5 MHz.
Att	(Rx Attenuation) 0 to 25 dB, in increments of .25dB.
Mute	(Mute setting) Muted (i.e., Tx off) or Unmuted (i.e., Tx on).
Slope	Manual (0.0 to 1.0, in increments of 0.1) or Calibrated .

Press **ENTER** when done.

10.3.3.3.3.1.1.3 ODU: FSK-control → CSAT (2CSATs → CSAT #X) → Configuration → LNA

```
LNA: State=On Calibrate-LNA-Current=N
Current-Window=50% Fault-Logic=Summary
```

Use the ◀▶ arrow keys to select a setting, and then use the ▲▼ arrow keys to change that setting:

Selection	Setting
State	(LNA State) Off or On . This controls whether or not the CSAT provides LNA Power via the Receive RF Cable.
Calibrate-LNA-Current	Select YES and press ENTER to calibrate the LNA current for use with the Current-Window function. (Default is NO .)
Current-Window:	A value from 20% to 50% defines the allowable LNA Current change before declaring a fault. Select 99% to <i>disable</i> the Current Window function.

Selection	Setting
Fault-Logic:	Summary or No-Summary. This controls whether or not an LNA Current-Window fault activates the Summary Fault Relay, and further permits you to select whether or not to switch the Online/Offline CSAT in the event of an LNA Current-Window fault.

Press **ENTER** when done.

10.3.3.3.3.1.1.4 ODU: FSK-control → CSAT (2CSATs → CSAT #X) → Configuration → Misc

```
Misc: Cold-Start=Disabled  AFR=Enable
      Xref=No    Ref-Adj=087 Sync-Clk=Y (◀ ▶ ⬆ ⬇)
```

Use the ◀▶ arrow keys to select a setting, and then use the ▲▼ arrow keys to change that setting:

Selection	Setting
Cold-Start	If enabled, when the CSAT is powered on, the IF and RF outputs remain muted for 15 minutes.
AFR	(Auto Fault Recovery) This defines how a CSAT reacts to momentary fault conditions: Off: CSAT mutes when faulted and remain muted. On: CSAT mutes when faulted, but unmute after the fault goes away.
Xref	(External Reference) The CSAT automatically locks to an external 5 or 10 MHz reference independent of the state of this selection. This selection determines whether or not the Summary Fault Relay activates if the CSAT loses lock with the external reference.
Ref-Adj	Select a value for the Internal 10MHz Reference setting from 000 to 255 . NOTE: The Internal Reference is set in the factory to be very accurate with the default setting of 087. This setting is provided to compensate for the long-term frequency drift of the oscillator.
Sync-Clk	(Default is NO .) Selecting YES and pressing ENTER causes the CSAT RTC (Real-Time Clock) to be synchronized to the Modem RTC.

Press **ENTER** when done.

10.3.3.3.3.1.2 ODU: FSK-control → CSAT (2CSATs → CSAT #X) → Monitor

```
Monitor:
  Tx   Rx   Misc  Power-Supplies  (◀ ▶)
```

To view these **read-only** displays, use the ◀▶ arrow keys to select **Tx**, **Rx**, **Misc**, or **Power-Supplies**, and then press **ENTER**.

Press **ENTER** or **CLEAR** after viewing any Monitor screen to return to the previous menu.

ODU: FSK-control → CSAT (2CSATs → CSAT #X) → Monitor → Tx

```
Tx: SynTune = 09.6 VDC   Power = <24 dBm
     IFLO = 11.1 VDC    Temp = 26 C
```

ODU: FSK-control → CSAT (2CSATs → CSAT #X) → Monitor → Rx

```
Rx: SynTuneE = 01.4 VDC
     IFLO = 11.2 VDC   Temp = 26 C
```

ODU: FSK-control → CSAT (2CSATs → CSAT #X) → Monitor → Misc

```
Misc: Ref-Tune = 03.0 VDC
       LNA = 00.05 mA   Fan = 550 mA
```

ODU: FSK-control → CSAT (2CSATs → CSAT #X) → Monitor → Power-Supplies

```
24V=24.1 VDC   12V=12.5VDC   +5V=+5.4VDC
20V=21.2 VDC   10V=10.2VDC   -5V=-5.3VDC
```

10.3.3.3.1.3 ODU: FSK-control → CSAT (2CSATs → CSAT #X) → Alarms

```
Alarms:
  Current-Alarms   Stored-Alarms (◀ ▶)
```

Use the ◀▶ arrow keys to select **Current-Alarms** or **Stored-Alarms**, and then press **ENTER**.

10.3.3.3.1.3.1 ODU: FSK-control → CSAT (2CSATs → CSAT #X) → Alarms → Current-Alarms

```
Current Status: Tx = OK      Rx = OK
                 Power-Supply = OK  Misc = OK
```

This screen is **read-only**. Press **ENTER** or **CLEAR** to return to the previous menu.\

10.3.3.3.1.3.2 ODU: FSK-control → CSAT (2CSATs → CSAT #X) → Alarms → Stored-Alarms

As stored events are compiled, the screen shows:

```
Reading Stored Faults..... Please Wait
```

Once the events are compiled, the Stored Alarms screen appears as shown here:

```
Stored Alarms: Clear-All: No (No, Yes)
IF #84: 10/14/04 12:52:08 Power On
```

Use the ◀▶ arrow keys to select between the log entries and the **Clear-All** option.

To view a log entry: With the cursor on the entry number, use the ▲▼ arrow keys to view through the entries. Up to 99 entries are stored. Each entry provides the following information:

Item	Comments
Entry type	<ul style="list-style-type: none"> • IF = Information • FT = Fault • OK = Fault cleared
Entry number	00 through 99
Date	European Day-Month-Year (DD-MM-YY) format
Time	Hour:Minute:Second (HH:MM:SS) format
Description of information / fault	Example: Power On

To clear the Stored Alarms Log, use the ◀▶ arrow keys to select **Clear-All**, and then use the ▲▼ arrow keys to select **Yes**. Press **ENTER** to clear the log.

10.3.3.3.1.4 ODU: FSK-control → CSAT (2CSATs → CSAT #X) → Info

```
Info:
Model Tx Rx Misc LNA (◀ ▶)
```

These **read-only** screens provide the ODU's current configuration information without risking inadvertent changes.

Use the ◀▶ arrow keys to select **Model**, **Tx**, **Rx**, **Misc**, or **LNA**, and then press **ENTER**. After viewing any CSAT/CSAT#X Info screen, press **ENTER** or **CLEAR** to return to the previous menu.

ODU: FSK-control → CSAT (2CSATs → CSAT #X) → Info → Model

```
Model: CSAT-5060/025 V2.19
S/N: 010300346
```

Use this screen to view the CSAT model number, its operating firmware, and the unit serial number.

ODU: FSK-control → CSAT (2CSATs → CSAT #X) → Info → Tx

```
Info: Tx:Off 6427.0MHz 23.00dB
      Amp:Off Unmuted Slope:0.3
```

Use this screen to view the Tx state, Frequency, Tx Attenuation, Amplifier state, Tx Mute state and Tx Slope adjustment (value or CAL).

ODU: FSK-control → CSAT (2CSATs → CSAT #X) → Info → Rx

```
Info: Rx:ON 3400.0MHz 18.00dB
      Ref:087 Unmuted Slope:0.2
```

Use this screen to view the Rx state, Rx Frequency, Rx Attenuation, Rx Reference, Rx Mute state and Rx Slope adjustment (value or CAL).

ODU: FSK-control → CSAT (2CSATs → CSAT #X) → Info → Misc

```
Info: Cold-Start:Off
      Auto-Fault-Recovery:Summary (EC)
```

Use this screen to view the Cold Start and Auto Fault Recovery settings.

ODU: FSK-control → CSAT (2CSATs → CSAT #X) → Info → LNA

```
Info: LNA:Off Fault-Logic:Summary
      Window:48% (EC)
```

Use this screen to view the Low Noise Amplifier operational settings.

10.3.3.3.2 ODU: FSK-control → 2CSATs



The menus that follow assume that you have selected and the system has identified two CSATs connected via the Rx IF port and the ODU Redundancy Controller Box.

```
1:1 Monitor & Control
  CSAT#1  CSAT#2  Redundancy-Box  (◀ ▶)
```

Use the ◀▶ arrow keys to select **CSAT#1**, **CSAT#2**, or **Redundancy-Box**, and then press **ENTER**.

10.3.3.3.2.1 ODU: FSK-control → 2CSATs → CSAT#X



This submenu and its nested menus are identical in form and function for the following menu structures:

```
ODU: FSK-control → CSAT →
ODU: FSK-control → 2CSATs → CSAT#X → (where CSAT#X = CSAT#1, CSAT#2)
```

```
CSAT-5060/050 v1.02
Configuration Monitor Alarms Info (◀ ▶)
```

Use the ◀▶ arrow keys to select **Configuration**, **Monitor**, **Alarms**, or **Info**, and then press **ENTER**.



Sect. 10.3.3.3.1 ODU: FSK-control → CSAT for complete information for these nested menu choices.

10.3.3.3.2.2 ODU: FSK-control → 2CSATs → Redundancy-Box

```
Red: Online: ODU2  Mode:Auto  Switch:N
TxSw:OK  RxSw:OK  5V:5.0  12V:12.0
```

This menu provides operating mode and switchover controls. You may also view the following **read-only** information here:

- Which of the two CSATs is currently online (**ODU1** or **ODU2**);
- Waveguide Switch Tx and Rx status: **OK** or **Ft** (fault);
- Redundancy Controller Box 5V and 12V values (to aid trouble-shooting system problems).

To set Operating Mode, use the ◀▶ arrow keys to select **Mode**, and then use the ▲▼ arrow keys to select this mode as **Auto** or **Manual**:

- **AUTO** mode – When the Online ODU faults, the switchover is done **automatically** to replace the faulty unit.



If the ODU Redundancy system is in **AUTO** mode, a ‘forced switch-over’ can only occur if the currently **OFFLINE** unit is fault-free.

- **MANUAL** mode – If selecting the mode as Manual, *there is no automatic switchover if a fault occurs.*

To force a switchover to the other CSAT unit, use the ◀▶ arrow keys to select **Switch: N**, and then use the ▲▼ arrow keys to select **Y** (Yes). Press **ENTER** when done.

10.3.3.3.3.3 ODU: FSK-control → KST

```
KST Select:
Configuration Information Alarms (◀ ▶)
```

Use the ◀▶ arrow keys to select **Configuration**, **Information**, or **Alarms**, and then press **ENTER**.

10.3.3.3.3.3.1 ODU: FSK-control → KST → Configuration

```
KST Config:
Tx Rx Miscellaneous (◀ ▶)
```

Use the ◀▶ arrow keys to select **Tx**, **Rx**, or **Miscellaneous**, and then press **ENTER**.

10.3.3.3.3.3.1.1 ODU: FSK-control → KST → Configuration → Tx

```
Tx:Off Freq=13955 MHz Att=23 dB
AGC=Off (◀ ▶ ⬇)
```

Use the ◀▶ arrow keys to select **Tx**, **Freq**, **Att**, or **AGC**, and then use the ▲▼ arrow keys to change that setting. Press **ENTER** when done.

10.3.3.3.3.3.1.2 ODU: FSK-control → KST → Configuration → Rx

```
Rx: Freq=11950 MHz Att=20 dB Ref=087
Band=B (◀ ▶)
```

Note that Rx Band is not shown for the KST-2000A.

Use the ◀▶ arrow keys to select **Freq**, **Att**, **Ref**, or **Band** (KST-2000B only), and then use the ▲▼ arrow keys to change that setting. Press **ENTER** when done.

10.3.3.3.3.1.3 ODU: FSK-control → KST → Configuration → Miscellaneous

```
HPA:Off      Fault-Logic=Summary
LNA:OFF      Fault-Logic=Summary  Cal:No
```

Use the ◀▶ arrow keys to select **HPA**, **(HPA) Fault-Logic-Summary**, **LNA**, **(LNA) Fault-Logic-Summary**, or **Cal**, and then use the ▲▼ arrow keys to change that setting:

Selection	Setting
HPA	(HPA power enable) Select Off or On .
Fault-Logic	This controls whether or not a HPA fault is indicated on the Fault status, and activates the Summary Fault Relay. Select Summary or No-Summary .
LNA	(LNA power enable) Select Off or On .
Fault-Logic	This controls whether or not a LNA fault is indicated on the Fault status, and I activates the Summary Fault Relay. Select Summary or No-Summary .
Cal	To calibrate, select YES and press ENTER . Calibration allows the system to determine nominal LNB or LNB power consumption, performed at initial installation only. (Default is NO .)

Press **ENTER** when done.

10.3.3.3.3.1.4 ODU: FSK-control → KST → Information

```
KST Info:  Model  Tx+Rx-Param
           Misc  Numbers  (◀ ▶)
```

These **read-only** screens provide the ODU's current configuration information without risking inadvertent changes.

Use the ◀▶ arrow keys to select **Model**, **Tx+Rx-Param**, **Misc**, or **Numbers**, and then press **ENTER**.

Once any KST Info screen has been viewed, press **ENTER** or **CLEAR** to return to the previous menu.

10.3.3.3.3.1.5 ODU: FSK-control → KST → Information → Model

```
MODEL:  KST-2000B
HPA:    CEFD-SSPA
```

This screen displays the KST and HPA model numbers.

10.3.3.3.3.1.6 ODU: FSK-control → KST → Information → Tx+Rx-Param

```
Info: Tx:Off    13955MHz    10dB
      Rx:       11950MHz    20dB    Ref:087
```

This screen displays the Tx and Rx states, Frequencies, and Attenuation, and the reference.

10.3.3.3.3.1.7 ODU: FSK-control → KST → Information → Misc

```
Info:          HPA:Off    Flt-Logic:No-Summ
      Band:B    LNA:Off    FLT-Logic:Summary
```

This screen displays the HPA and LNA operational and fault logic summary settings.



Note that the Rx Band information is not shown for the KST-2000A.

10.3.3.3.3.1.8 ODU: FSK-control → KST → Information → Numbers

```
M&C:          F/W:9364-1B    VER:01.01.03
      assy:9357-1A    S/N:021476493
```

Use the ▲▼ arrow keys to view the Up-Converter, Down-Converter and HPA assembly and serial numbers as well as their firmware numbers/versions.

10.3.3.3.3.1.9 ODU: FSK-control → KST → Alarms

```
Current Status: Up:OK    Ref:OK    AGC:OK
                P-Supplies:OK    Dn:OK    HPA:OK    LNA:OK
```

This is Summary Status information. Use the ◀▶ arrow keys to select **Up**, **Ref**, **AGC**, **Power-Supplies**, **Down**, **HPA**, or **LNA**, and then press **ENTER**. A detailed status screen, similar to the following examples, is then shown:

```
Up-Converter:  Comms:OK    L-Synth:OK
                Over-Temp:OK    Ku-Synth:OK
```

```
Reference:Warm    72M-Lock:OK    Range:NA
                Source:IntT    Xref-Lock:NA    Phase:NA
```

```
AGC Status:      Excess-Power-In:OK
                Loop-Conv:OK    Insuff-Power-In:OK
```

```
P-Supplies:  7V:OK    17V:OK
              -7V:OK   12V:OK    (EC)
```

```
Down-Converter:  Comms:OK    L-Synth:OK
                  Over-Temp:OK  Ku-Synth:OK
```

```
HPA:    Comms:OK          9.75V:OK
         Over-Temp:OK    Bias:OK          -5V:OK
```

Once any KST Alarms screen has been viewed, press **ENTER** or **CLEAR** to return to the previous menu.

10.3.3.3.4 ODU: FSK-control → BUC



The menus that follow assume that you have selected and the system has identified a BUC connected via the Tx IF port.

```
BUC controls via FSK:
Configuration  Status  Advanced-FSK  (◀ ▶)
```

Use the ◀▶ arrow keys to select **Configuration**, **Status**, or **Advanced-FSK**, and then press **ENTER**.

10.3.3.3.4.1 ODU: FSK-control → BUC → Configuration

```
BUC: Tx:On  (Off,On)
      Addr:01 (1-15)          (◀ ▶ ⬇)
```

Use the ◀▶ arrow keys to select **Tx:** or **Addr:**

On the top line – For **Tx:** use the ▲▼ arrow keys to select **Off** or **On**.

On the bottom line – For **Addr:** use the ▲▼ arrow keys to select an address from **01** to **15**. Press **ENTER** when done.

10.3.3.3.4.2 ODU: FSK-control → BUC → Status

```
BUC: Pwr=16.2dBm=00.0W    Pclass=5 W
      PLL=locked    +045°C    Sw-Ver=01
```

This screen provides **read-only** status information for the BUC setup.

Press **ENTER** or **CLEAR** to return to the previous menu.

10.3.3.3.3.4.3 ODU: FSK-control → BUC → Advanced-FSK

```
Advanced FSK:  
CEFD BUC Type: LPOD (LPOD, 2LPODs) (◀▶)
```

Use the ▲▼ arrow keys to select **LPOD** or **2LPODs**, and then press **ENTER**.

10.3.3.3.3.4.3.1 ODU: FSK-control → BUC → Advanced-FSK → LPOD (2LPODs → Online/Offline LPOD)

```
LPOD S/N: 123456789  
Cnfg Monitor Alarms Stats Info Redun (◀▶)
```



This submenu and its nested menus are identical in form and function for the following menu structures:

```
ODU: FSK-control → Advanced-FSK → LPOD→  
ODU: FSK-control → Advanced-FSK → 2LPODs → Online LPOD→  
ODU: FSK-control → Advanced-FSK → 2LPODs → Offline LPOD→
```

Use the ◀▶ arrow keys to select **Cnfg**, **Monitor**, **Alarms**, **Stats**, **Info**, or **Redun**, and then press **ENTER**.

10.3.3.3.3.4.3.1.1 ODU: FSK-control → BUC → Advanced-FSK → LPOD (2LPODs → Online/Offline LPOD) → Cnfg

```
Configuration settings:  
Amplifier LNB Mask Misc (◀▶)
```

Use the ◀▶ arrow keys to select **Amplifier**, **LNB**, **Mask**, or **Misc**, and then press **ENTER**.

ODU: FSK-control → BUC → Advanced-FSK → LPOD (2LPODs → Online/Offline LPOD) → Cnfg → Amplifier

```
Amplifier: Att=10.00 dB Amp=On  
Mute=Disabled Att-Offset=00.00 dB (◀▶◄)
```

Use the ◀▶ arrow keys to select a setting, and then use the ▲▼ arrow keys to change that setting:

Selection	Setting
Att	(Attenuation) 0 to 20 dB, in increments of .25dB. Limit and increments are variable based upon unit Info string.
Amp	(Amplifier setting) Off or On
Mute	(Mute Mode) Disabled (i.e., Tx off) or Enabled (i.e., Tx on)
Att-Offset	(Attenuation Offset) 0 to 20 dB, in .25 dB increments

Press **ENTER** when done.

ODU: FSK-control → BUC → Advanced-FSK → LPOD (2LPODs → Online/Offline LPOD) → Cnfg → LNB

```
LNB Current: Src=On   SwitchBiasTee=Thru
Window:30% Alarm=Disabled Cal=No (◀ ▶ ⬆)
```

Use the ◀▶ arrow keys to select a setting, and then use the ▲▼ arrow keys to edit the setting:

Selection	Setting
Src	(LNB Current Source) Disabled or Enabled.
SwitchBiasTee	Off (mute LNB) or Thru (unmute LNB).
Window	(LNB Current-Window) Selecting a value from 20% to 50% defines the allowable LNB Current change before declaring a fault. Selecting 99% disables the Current Window function.
Alarm	(LNB Current Window Alarm Enable) Disable or Enable the current window alarm.
Cal	(Calibrate-LNB-Current) Select Yes and press ENTER to calibrate the LNB current. (Default is No .) Note: LNB Current Source must be Enabled before the LNB current can be calibrated.

Press **ENTER** when done.

ODU: FSK-control → BUC → Advanced-FSK → LPOD (2LPODs → Online/Offline LPOD) → Cnfg → Mask

```
Mask: LFRFPwr=Masked ERLD=Masked (◀ ▶ ⬆)
FanSpd=Masked LNBCD=Alarm LNB22V=Masked
```

First, use the ◀▶ arrow keys to select **LFRFPwr** (Low Forward RF Power), **ERLD** (External Reference Lock detect), **FanSpd** (Fan Speed), **LNBCD** (LNB Current Detect), or **LNB22V** (LNB 22V Power Supply)

Then, for each selection, use the ▲▼ arrow keys to set that alarm to **Fault**, **Alarm**, or **Masked**. Press **ENTER** when done.

ODU: FSK-control → BUC → Advanced-FSK → LPOD (2LPODs → Online/Offline LPOD) → Configuration → Misc

```
Misc: AFR=Enabled Ref-Adjust=087 (◀ ▶ ⏏)
LowFwdPowerThreshold=00.00 Sync-Clock=No
```

Use the ◀▶ arrow keys to select a setting, and then use the ▲▼ arrow keys to edit the setting:

Selection	Setting
AFR	(Auto Fault Recovery) This defines how a LPOD reacts to momentary fault conditions: <ul style="list-style-type: none"> • Disable – LPOD mutes when faulted and remain muted. • Enable – LPOD mutes when faulted, and then unmutes once the fault goes away.
Ref-Adjust	Select an Internal 10MHz Reference setting from 000 to 255. NOTE: The Internal Reference is set in the factory to be very accurate with the default setting of 087. This setting is provided to compensate for the long-term frequency drift of the oscillator.
LowFwdPower Threshold	This sets the threshold for the low forward power alarm/fault. An alarm/fault is triggered if the forward power drops below the specified value. Set this setting to 00.00 to disable the threshold.
Sync-Clock	Select YES and press ENTER to synchronize the LPOD RTC to the Modem RTC. (Default is NO .)

Press **ENTER** when done.

10.3.3.3.4.3.1.2 ODU: FSK-control → BUC → Advanced-FSK → LPOD (2LPODs → Online/Offline LPOD) → Monitor

```
Monitor: Tx Temperature FET Misc
Power-Supplies1 Power-Supplies2 (◀ ▶)
```

To view these **read-only LPOD Monitor** screens, use the ▲▼ arrow keys to select **Tx**, **Temp**, **FETs**, **Misc**, or **Power-Supplies**, and then press **ENTER**.

Once any of these screens are viewed, press **ENTER** or **CLEAR** to return to the previous menu.

ODU: FSK-control → BUC → Advanced-FSK → LPOD (2LPODs → Online/Offline LPOD) → Monitor → Tx

```
Tx: RefTune=009.6 V FwdPower = +20.4 dBm
BUCTune=011.1 V
```

ODU: FSK-control → BUC → Advanced-FSK → LPOD (2LPODs → Online/Offline LPOD) → Monitor → Temperature

```
Temperature: Heat Sink=048.0°C  
External Air=030.0°C
```

ODU: FSK-control → BUC → Advanced-FSK → LPOD (2LPODs → Online/Offline LPOD) → Monitor → FETs

```
RF Power FETs Total = 20.301 Amps
```

ODU: FSK-control → BUC → Advanced-FSK → LPOD (2LPODs → Online/Offline LPOD) → Monitor → Misc

```
Fan1Speed=100.0% Fan2Speed=100.0%  
LNB Current Draw=005.5mA
```

ODU: FSK-control → BUC → Advanced-FSK → LPOD (2LPODs → Online/Offline LPOD) → Monitor → Power-Supplies1

```
P24V1=024.1 P24V2=024.0 LNVBT=022.1  
P13VT=013.7 P10V1=010.3 A10V1=010.0
```

ODU: FSK-control → BUC → Advanced-FSK → LPOD (2LPODs → Online/Offline LPOD) → Monitor → Power-Supplies2

```
A10V2=N/A P7V8T=007.8 P5V8t=005.7  
P2V5T=002.5 P1V2T=001.2 N5V8T=-05.6
```

10.3.3.3.3.4.3.1.3 ODU: FSK-control → BUC → Advanced-FSK → LPOD (2LPODs → Online/Offline LPOD) → LPOD → Alarms

```
Alarms:  
Current-Alarms Stored-Events (◀ ▶)
```

Use the ◀▶ arrow keys to select **Current-Alarms** or **Stored-Alarms**, and then press **ENTER**.

ODU: FSK-control → BUC → Advanced-FSK → LPOD (2LPODs → Online/ Offline LPOD) → Alarms → Current-Alarms

```
P24V1=OK P24V2=OK LNVBT=OK P13VT=OK  
P10V1=OK A10V1=OK A10V2=OK P7V8T=OK (↕)
```

Use the ▲▼ arrow keys to view additional Current Alarm status screens. Press **ENTER** or **CLEAR** to return to the previous menu.

ODU: FSK-control → BUC → Advanced-FSK → LPOD (2LPODs → Online/Offline LPOD) → Stored-Events

As events are compiled, the Stored-Events screen appears as shown here:

```
Reading Stored Events.... Please Wait
```

Once all events are compiled, the Stored-Events screen appears as shown here:

```
Stored Events: Clear-All: No (No, Yes)
#084 Info - PWR ON 10/12/10 12:52:08
```

On the top line – Use the ◀▶ arrow keys to select between log entries and the **Clear-All** option.

To clear the Stored -Events Log, use the ▲▼ arrow keys to select **Clear-All**, and then use the ▲▼ arrow keys to select **Yes**. Press **ENTER** when done.

On the bottom line – **To view the Stored-Events Log**: With the cursor on the entry number, use the ▲▼ arrow keys to scroll through the entries. Up to 512 entries are stored.

Each entry provides the following information:

Item	Comments
Entry Type	<ul style="list-style-type: none"> • Info (Information) • Fault • Clear (fault cleared)
Entry Number	001 through 511
Date	European Day-Month-Year (DD-MM-YY) format
Time	Hour:Minute:Second (HH:MM:SS) format
Description of the fault/information	Example: Info – PWR ON

10.3.3.3.4.3.1.4 ODU: FSK-control → BUC → Advanced-FSK → LPOD (2LPODs→ Online/Offline LPOD)→ Statistics

```
Statistics:
Config Stored-Statistics (◀ ▶)
```

Use the ▲▼ arrow keys to select **Config** or **Stored-Statistics**, and then press **ENTER**.

ODU: FSK-control → BUC → Advanced-FSK → LPOD (2LPODs→ Online/Offline LPOD)→ Statistics →Config

```
Stats: Logging=Enabled Interval=10 min  
Averaging=Disabled Clear-All=No (◀▶↕)
```

Use the ▲▼ arrow keys to select **Logging**, **Interval**, **Averaging**, or **Clear-All**, and then use the ▲▼ arrow keys to set that setting:

Selection	Setting
Logging	Enabled or Disabled.
Interval	The Logging Interval is the period of time over which performance statistics are measured. Set this interval as 00 to disable the feature (i.e., no logging) or, otherwise, define the logging interval from 10 through 90 minutes in 10-minute increments.
Averaging	Enabled or Disabled.
Clear-All	When prompted, select YES.

Press **ENTER** when done.

ODU: FSK-control → BUC → Advanced-FSK → LPOD (2LPODs→ Online/Offline LPOD) → Statistics → Stored-Statistics

To enable statistics logging, see the **LPOD → Statistics: Config** menu. As statistics are compiled, the Stored-Statistics screen appears as shown here:

```
Reading Stored Stats..... Please Wait
```

Once the statistics are compiled, the Stored-Statistics screen displays this data as shown here:

```
Stats001: 000.0C 040.0C 20.45dBm 10.00dB  
10/01/10 12:52:08 On On Off 001.0 002.3V
```

Use the ▲▼ arrow keys to scroll backwards or forwards through the statistics log entries.
The top line displays:

- The statistics log entry number (up to 512 entries may be stored)
- Operating Temperature
- Amplifier Temperature
- Power

- Attenuation

The bottom line displays:

- Entry date (in DAY-MONTH-YEAR format)
- Entry Time (in HH:MMSS format)
- **On/Off** state for RF Amplifier mode
- **On/Off** state for Mute mode
- Online state (**Online/Offline**)
- LNB current
- BUC Tuning Voltage

Press **ENTER** or **CLEAR** to return to the previous menu.

10.3.3.3.3.4.3.1.5 ODU: FSK-control → BUC → Advanced-FSK → LPOD (2LPODs → Online/Offline LPOD) → Information

```
Info:
  Model  Amp  LNB  Mask  Misc      (◀ ▶)
```

These **read-only** screens provide you with the ODU's current configuration information without risking inadvertent changes. Use the ◀▶ arrow keys to select **Model**, **AMP**, **LNB**, **Mask**, or **Misc**, and then press **ENTER**.

For any LPOD Information screen: Once viewed, press **ENTER** or **CLEAR** to return to the previous menu.

ODU: FSK-control → BUC → Advanced-FSK → LPOD (2LPODs → Online/Offline LPOD) → Information → Model

```
PS1032-1375145-K REF BUC V1.2.2
S/N: 101101068          VER: 1.3.1
```

This screen displays the **LPOD** model number, the unit serial number and its operating firmware.

ODU: FSK-control → BUC → Advanced-FSK → LPOD (2LPODs → Online/Offline LPOD) → Information → Amp

```
Amp Info: Att=20.00dB Amp=On  
Mute=Disabled Att-Offset=00.00dB
```

This screen displays the RF Amplifier state, RF Mute state, Attenuation, and AUX Mute state.

ODU: FSK-control BUC → Advanced-FSK → LPOD (2LPODs → Online/Offline LPOD) → Information → LNB

```
LNB Current: Src=On SwitchBiasTee=Off  
Window:30% Alarm=Disabled
```

This screen displays the LNB Current information.

ODU: FSK-control → BUC → Advanced-FSK → LPOD (2LPODs → Online/Offline LPOD) → Information → Mask

```
Mask: LFRFPwr=Masked ERLD=Masked  
FanSpd=Alarm LNBCD=Alarm LNB22V=Alarm
```

This screen displays the LPOD mask settings.

ODU: FSK-control → BUC → Advanced-FSK → LPOD (2LPODs → Online/Offline LPOD) → Information → Misc

```
Misc: AFR=Enabled Ref-Adjust=087  
LowFwdPowerThreshold=00.00
```

This screen displays the Auto Fault Recovery state, the Internal 10MHz Reference setting, and the Low Forward Power Threshold setting.

10.3.3.3.3.4.3.1.6 ODU: FSK-control → BUC → Advanced-FSK → LPOD (2LPODs → Online/Offline LPOD) → Redun

```
Redundancy-Switch-Mode=1:1 Red TX+RX
Force-Online=N Online-State=Offline (◀ ▶ ⏏)
```

Use the ◀▶ arrow keys to select a setting, and then use the ▲▼ arrow keys to change that setting:

Selection	Setting
Redundancy-Switch-Mode	Off, 1:1 Red Tx, 1:1 Red TX+RX, Manual.
Force-Online	Select Yes to force Offline unit to generate a redundant switchover. Otherwise, select No .
Online-State	Read-only. Displays status as Online or Offline .

Press ENTER when done.

ODU: FSK-control → BUC → Advanced-FSK → 2LPODs



The menus that follow assume that you have selected, and the system has identified, two LPODs connected via the Tx IF port.

```
1:1 Monitor & Control
Online LPOD Offline LPOD (◀ ▶)
```

Use the ◀▶ arrow keys to select **Online LPOD** or **Offline LPOD**, and then press ENTER.

ODU: FSK-control → BUC → Advanced-FSK → 2LPODs → Online LPOD

ODU: FSK-control → BUC → Advanced-FSK → 2LPODs → Offline LPOD

```
LPOD S/N: 123456789
Cnfg Monitor Alarms Stats Info Redun (◀ ▶)
```

Use the ◀▶ arrow keys to select **Cnfg**, **Monitor**, **Alarms**, **Stats**, **Info**, or **Redun**, and then press ENTER.



Sect. 10.3.3.3.3.4.3.1 ODU: FSK-control → BUC → Advanced-FSK → LPOD for complete information for these nested menu choices.

10.4 ODU Operations via the CDM-625A HTTP (Web Server) Interface



The CDM-625A Advanced Satellite Modem's embedded HTTP Interface provides an easy to use application to configure and monitor all aspects of an ODU. See Chapter 7. ETHERNET-BASED REMOTE PRODUCT MANAGEMENT for complete instructions on using this interface.



The Comtech EF Data LPOD Amplifier / Block Up Converter is not supported by the CDM-625A HTTP Interface at this time.

A user-supplied web browser allows the full monitor and control (M&C) of an installed Comtech EF Data CSAT-5060 or KST-2000A/B Transceiver (ODU), installed in standalone or 1:1 Redundancy configurations, from the CDM-625A's Web Server Interface. This embedded web application is designed for, and works best with, Microsoft's Internet Explorer Version 7.0 or higher.

10.4.1 Web Server Interface and Menu Tree

Type the CDM-625A's IP Address into the **Address** area of the user-supplied web browser, and then enter a valid User Name and Password is accepted. You will see the CDM-625A Web Server Interface "splash" page (**Figure 10-3**). Note that the Base Modem and Packet Processor **Firmware Versions** shown in this example are subject to change.



Figure 10-3. CDM-625A HTTP (Web Server) Interface Home Page

The **Figure 10-4** menu tree illustrates the ODU options available through the CDM-625A HTTP Interface. The CDM-625A Web Server Interface provides access to six (6) navigation tabs (shown in blue). Beyond this top-level row of navigation tabs, the diagram illustrates the available primary (green) and nested (yellow) page tabs that afford you more specific functionality.

Tabs not specific to ODU operation appear dimmed and are explicitly defined in **Chapter 7. ETHERNET-BASED REMOTE PRODUCT MANAGEMENT**. Click a navigation tab to continue.

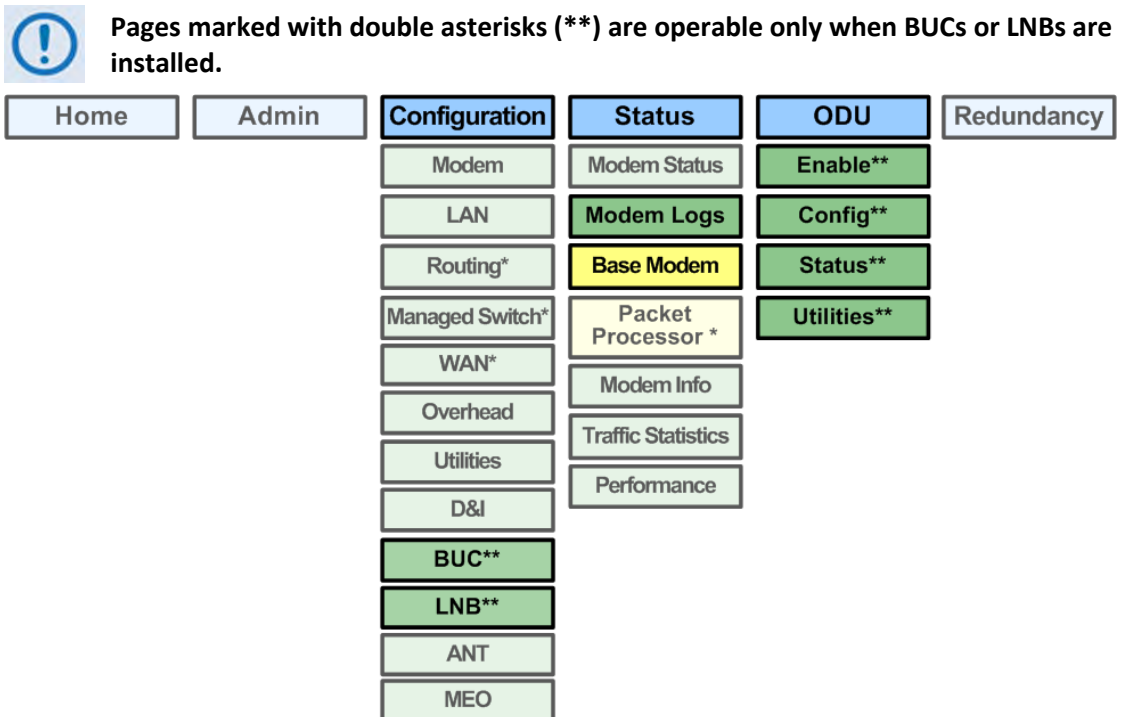

Figure 10-4. CDM-625A HTTP (Web Server) Interface Menu Tree (FW Ver. 1.4.1)

10.4.2 Web Page Descriptions

10.4.2.1 Configuration | BUC (Block Up Converter) Page

When a Block Up Converter (BUC) is available, use this page to configure its operating settings and to view the BUC status for L-Band operation.

The screenshot shows the 'CDM-625A: Comtech EF Data Modem :: Block Up Converter' web page. The navigation menu includes Home, Admin, Configuration, Status, ODU, Redundancy, Modem, LAN, Routing, Managed Switch, WAN, Overhead, Utilities, D&I, BUC, LNB, ANT, and MEO. The BUC Configuration section includes fields for BUC Power Enable (OFF), BUC 10 MHz Ref Enable (OFF), BUC Output Power Enable (OFF), BUC Low Current Limit (0 mA), BUC High Current Limit (2000 mA), TX LO Frequency (0 MHz), and BUC Address (1). A 'Submit BUC Controls' button is present. The BUC Status section, which refreshes every 10 seconds, displays BUC Current (0 mA), BUC Voltage (00.0 volts), BUC Output Power Level (N/A dBm), BUC Phase Lock Loop (N/A), BUC Temperature (N/A degrees C), BUC Power Class (N/A watts), and BUC Software Version (N/A).

Figure 10-5. Configuration | BUC page

BUC Configuration

- **BUC Power Enable, 10 MHz Ref Enable, and Output Power Enable** – Use the drop-down lists to turn these functions **ON** or **OFF**.
- **BUC Low and High Current Limit** – Assign a value (in mA) ranging from **0** to **4000**.
- **Tx LO (Low Oscillator) Frequency** – Assign a value (in MHz) to the Tx LO Frequency, and then use the drop-down list to designate the value as a **HIGH (+)** or **LOW (-)** limit.
- **BUC Address** – Assign a value for the BUC Address from **1** to **15**.

Click **[Submit BUC Controls]** to save the setting changes made in this section.

BUC Status

This section refreshes automatically every ten seconds. These status settings are **read-only** and cannot be changed.

10.4.2.2 Configuration | LNB (Low Noise Block Down Converter)

When a Low Noise Block Down Converter (LNB) is available, use this page to configure its operating settings and to view the LNB status for L-Band operation.

The screenshot shows the 'CDM-625A: Comtech EF Data Modem :: Low Noise Block Down Converter' configuration page. The page has a navigation menu with tabs for Home, Admin, Configuration, Status, ODU, and Redundancy. Below this is a sub-menu with tabs for Modem, LAN, Routing, Managed Switch, WAN, Overhead, Utilities, D&I, BUC, LNB, ANT, and MEO. The 'LNB Control' section contains the following fields: LNB DC Power (OFF), LNB Reference Enable (OFF), LNB Current Threshold Low (0 mA), LNB Current Threshold High (500 mA), and RX LO Frequency (0 MHz) with a HIGH (-) limit. A 'Submit LNB Controls' button is located below these fields. The 'LNB Status (Refreshes every 5 seconds)' section shows LNB Current (0 mA) and LNB Voltage (00.0 volts).

Figure 10-6. Configuration | LNB page

LNB Control

- **LNB DC Power** and **LNB Reference Enable** – Use the drop-down lists to turn either function **ON** or **OFF**.
- **LNB Low** and **High Current Threshold** – Assign a value (in mA) ranging from **0** to **500** for either function.
- **Rx LO (Low Oscillator) Frequency** – Assign a value (in MHz) to the Rx LO Frequency, and then use the drop-down list to designate the value as a **HIGH (+)** or **LOW (-)** limit.

Click [**Submit LNB Controls**] to save.

LNB Status (Refreshes every 5 seconds)

This section refreshes automatically every five seconds. These status settings are **read-only** and cannot be changed.

10.4.2.3 Status | Modem Logs | Base Modem Page

Use this page to control how the CDM-625A processes ODU faults and alarms.

The screenshot shows the 'CDM-625A: Comtech EF Data Modem :: Modem Logs' interface. It features a navigation menu with tabs for Home, Admin, Configuration, Status, ODU, and Redundancy. Below this, there are sub-tabs for Modem Status, Modem Logs, Modem Info, Traffic Statistics, and Performance. The 'Modem Logs' sub-tab is active, and within it, 'Base Modem' and 'Packet Processor' are selected.

The main content area is divided into three sections:

- Events Log:** Contains radio buttons for 'Read Next Five Events' (selected), 'Clear Events Log', and 'Initialize Events Pointer', along with a 'Submit' button. A scrollable window displays event logs with columns for 'Info', 'Log Erased', and a timestamp '12:09:48 20-11-14'. The log shows 'Empty' entries. An 'Unread Events' counter is set to '000'.
- Statistics Log:** Contains radio buttons for 'Read Next Five Statistics' (selected), 'Clear Statistics Log', and 'Initialize Statistics Pointer', along with a 'Submit' button. A scrollable window shows 'No New Entry'. An 'Unread Statistics' counter is set to '000'.
- Alarm Mask:** A grid of controls for various alarm types, each with 'Masked' and 'Active' radio buttons:
 - Tx AIS:** Masked (selected), Active
 - Rx AIS:** Masked (selected), Active
 - Buffer slip:** Masked, Active (selected)
 - Rx AGC:** Masked (selected), Active
 - Eb/No:** Masked (selected), Active
 - CnC Lock:** Masked (selected), Active
 - BUC:** Masked, Active (selected)
 - LNB:** Masked, Active (selected)
 - G.703 LOS:** Masked, Active (selected)
 - Reference:** Masked, Active (selected)
 - Tx Clock:** Masked (selected), Active
 A 'Submit Alarm Mask' button is located at the bottom.

Figure 10-7. Status | Modem Logs | Base Modem page

Events Log

- **Unread Events** – Displays the total number of *unread* stored events in the scrollable events window. As you display stored event groups, this number decrements accordingly.
- **Read Next Five Events** – Click to buffer the next group of five stored events into the scrollable events window.
- **Clear Events Log** – Click to wipe clean the stored events log.
- **Initialize Events Pointer** – Click to reset the log’s internal pointer.

Click **[Submit]** to save.

Statistics Log

- **Read Next Five Statistics** – Click to buffer the next group of five stored events into the scrollable statistics window.

- **Clear Statistics Log** – Click to wipe clean the stored statistics log.
- **Initialize Statistics Pointer** – Click to reset the log's internal pointer.
- **Unread Statistics** – Displays the total number of *unread* stored statistics in the scrollable statistics window. As stored statistics are displayed, this number decrements accordingly.

Click **[Submit]** to save.

Alarm Mask

Use the available option buttons to define a designated BUC or LNB alarm as **Masked** or **Active**, and then click **[Submit Alarm Mask]** to save these changes.

10.4.2.4 ODU Pages



All ODU pages are viewable with all three levels of user login. However, you may submit changes to the 'ODU | Config' and 'ODU | Utilities' pages only if you have Administrative or Read/Write privileges.

When configuring the CDM-625A for 70/140 MHz operation, use the 'ODU (Outdoor Unit)' pages to control and monitor the **CSAT-5060** or **KST-2000A/B** Outdoor Unit that is connected via FSK to the CDM-625A.



ODU Comms must be Enabled, and the CDM-625A must be configured for 70/140 MHz operation, in order to fully access the 'ODU | Config', 'ODU | Status', and 'ODU | Utilities' pages.

If the CDM-625A is otherwise configured for L-Band operation and selection of the 'ODU | Config', 'ODU | Status', and 'ODU | Utilities' pages is attempted, the following error message displays:



When you configure the CDM-625A for L-Band operation, use the 'ODU | Enable' page to enable FSK operation for BUC products.

Select the **Enable**, **Config**, **Status**, or **Utilities** tab to continue.

10.4.2.4.1 ODU | Enable

Use this page to enable or disable communications with **CSAT-5060** or **KST-2000A/B** ODUs for 70/140 MHz operation, or **LPOD** BUCs for L-Band operation (see **Sect. 10.4.2.1 Configuration | BUC (Block Up Converter)**).



Figure 10-8. ODU | Enable page

ODU Comms

Use the drop-down list to select ODU operation as **Disabled** or **Enabled**, and then click **[Submit]**. If you encounter a communications issue – e.g., an ODU is either physically not present or the ODU Comms cable is not connected to the CDM-625A – the following error page displays after clicking **[Submit]**:

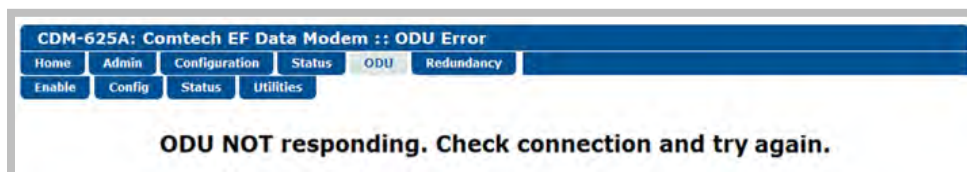

Take steps to troubleshoot the ODU setup before attempting to enable ODU operations from this page. See your pertinent ODU *Installation and Operation Manual* for further information.

10.4.2.4.2 ODU | Config Pages

When you configure either the Comtech EF Data **CSAT-5060** or **KST-2000A/B** as the ODU, you may use this page to configure operating settings specific to the active unit. **Otherwise**, when you attempt to access this page without first **enabling** ODU communications per the previous section, the following error page displays:

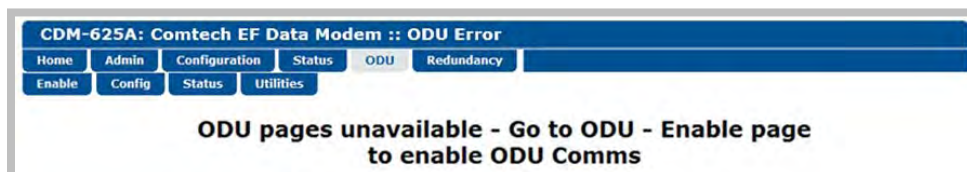

10.4.2.4.2.1 ODU | Config (CSAT-5060)

Figure 10-9 shows the 'ODU | Config' page as it appears with you configure the Comtech EF Data **CSAT-5060** as the ODU. Use this page to configure the primary ODU's Transmit and Receive Parameters.

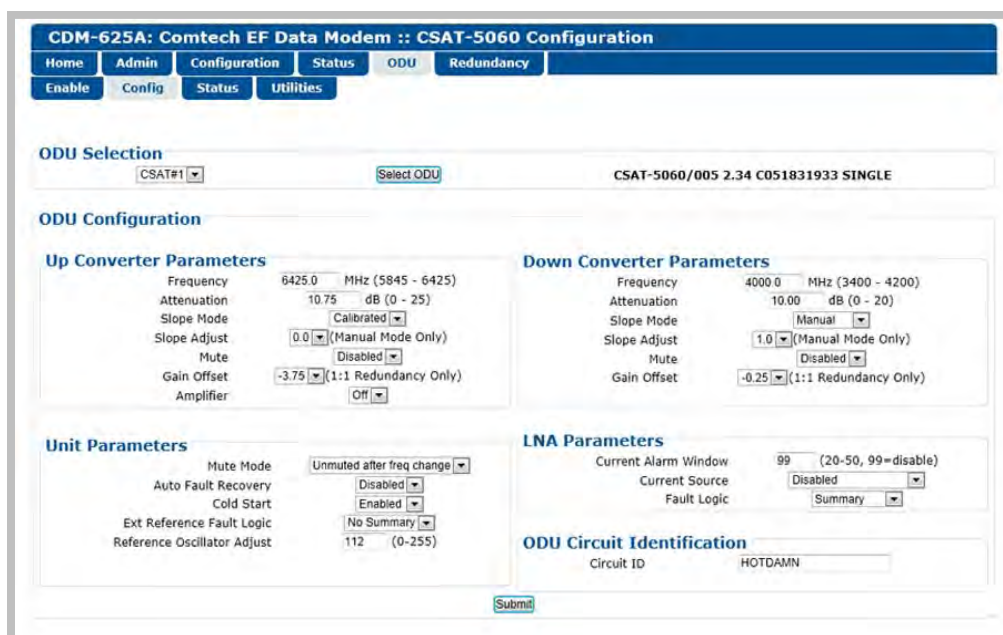

Figure 10-9. ODU | Config page (CSAT-5060)

ODU Selection

If you use ODUs in redundancy, you may toggle this page between the **Online** and **Offline** units. Use the drop-down list to select **CSAT #1** or **CSAT #2**, and then click **[Select ODU]**. A message in the right hand column of this section identifies which unit is **'ONLINE'**.

Up Converter Parameters

- **Frequency** – Enter a value in MHz.
- **Attenuation** – Enter a value in dB.
- **Slope Mode** – From the drop-down list, select **Manual** or **Calibrated**.
- **Slope Adjust (Manual Mode Only)** – Select the desired setting from the drop-down list.
- **Mute** – From the drop-down list, select **Disable** or **Enable**.
- **Gain Offset (1:1 Redundancy Only)** – Select the desired setting from the drop-down list.
- **Amplifier** – From the drop-down list, select **On** or **Off**.

Down Converter Parameters

- **Frequency** – Enter a value in MHz.
- **Attenuation** – Enter a value in dB.
- **Slope Mode** – From the drop-down list, select **Manual** or **Calibrated**.
- **Slope Adjust (Manual Mode Only)** – Select the desired setting from the drop-down list.
- **Mute** – From the drop-down list, select **Disable** or **Enable**.
- **Gain Offset (1:1 Redundancy Only)** – Select the desired setting from the drop-down list.

Unit Parameters

- **Mute Mode** – From the drop-down list, select **Muted** after freq change or **Unmuted** after freq change.
- **Auto Fault Recovery, Cold Start, and Ext Reference Fault Logic** – From the drop-down lists, select **Disable** or **Enable**.
- **Reference Oscillator Adjust** – Enter a value from 0-255.

LNA Parameters

- **Current Alarm Window** – Enter a value of **20-50**, or **99** to disable this feature.
- **Current Source** – From the drop-down list, select **Disable** or **Enable**.
- **Fault Logic** – From the drop-down list, select **Summary** or **No Summary**.

ODU Circuit Identification

Enter an ODU Circuit Identification name of up to 24 alphanumeric characters.

Click [**Submit**] to save.

10.4.2.4.2.2 ODU | Config (KST-2000A/B)

Figure 10-10 shows the 'ODU | Config' page as it appears when you configure the Comtech EF Data KST-2000A/B as the ODU. Use this page to configure the primary ODU's Transmit and Receive Parameters.

CDM-625A: Comtech EF Data Modem :: KST-2000A/B Configuration

Home Admin Configuration Status ODU Redundancy

Enable Config Status Utilities

KST-2000A/B Configuration

Up Converter
Frequency: 14250.0 MHz
Attenuation: 20.0 dB
Output: Off

Down Converter
Frequency: 11950.0 MHz
Attenuation: 00.0 dB
Rx Band (For KST-2000B only): NA

HPA
HPA Power Enable: Off
HPA Fault Logic: No Summary

LNA
LNA Power Enable: Off
LNA Fault Logic: Summary

Unit
AGC: Off
Reference Oscillator Adjust: 128
Circuit ID: -----CIRCUIT ID-----
Lock Mode: Off

Submit

Figure 10-10. ODU | Config page (KST-2000A/B)

Up Converter

- **Frequency** – Enter a value in MHz.
- **Attenuation** – Enter a value in dB.
- **Output** – From the drop-down list, select **On** or **Off**.

Down Converter

- **Frequency** – Enter a value in MHz.
- **Attenuation** – Enter a value in dB.
- **Rx Band (For KST-2000B Only)** – From the drop-down list, select **band A (10950 to 11700 MHz)**, **band B (11700 to 12200 MHz)**, or **band C (12250 to 12750 MHz)**.

HPA

- **HPA Power Enable** – From the drop-down list, select **On** or **Off**.
- **HPA Fault Logic** – From the drop-down list, select **Summary** or **No Summary**.

LNA

- **LNA Power Enable** – From the drop-down list, select **On** or **Off**.
- **LNA Fault Logic** – From the drop-down list, select **Summary** or **No Summary**.

Unit

- **AGC (Automatic Gain Control)** – From the drop-down list, select **On** or **Off**.
- **Reference Oscillator Adjust** – Enter a value from **0-255**.
- **Circuit ID** – Enter a Circuit Identification name of up to 24 alphanumeric characters.
- **Lock Mode** – From the drop-down list, select **On** or **Off**.

Click [**Submit**] to save.

10.4.2.4.3 ODU | Status



The appearance of the 'ODU | Status' page adjusts to the type of ODU that is configured for operation with the CDM-625A.

Use this page to review **read-only** status windows pertaining to the current operating condition for either the Comtech EF Data **CSAT-5060** or the **KST-2000A/B** ODU.

10.4.2.4.3.1 ODU | Status (CSAT-5060)

Figure 10-11 shows the 'ODU | Status' page as it appears when you configure the Comtech EF Data **CSAT-5060** as the ODU. Use this page to review **read-only** status reports pertaining to the ODU's Maintenance Parameters; Alarms; and the number of Unread Events in the Events Log.

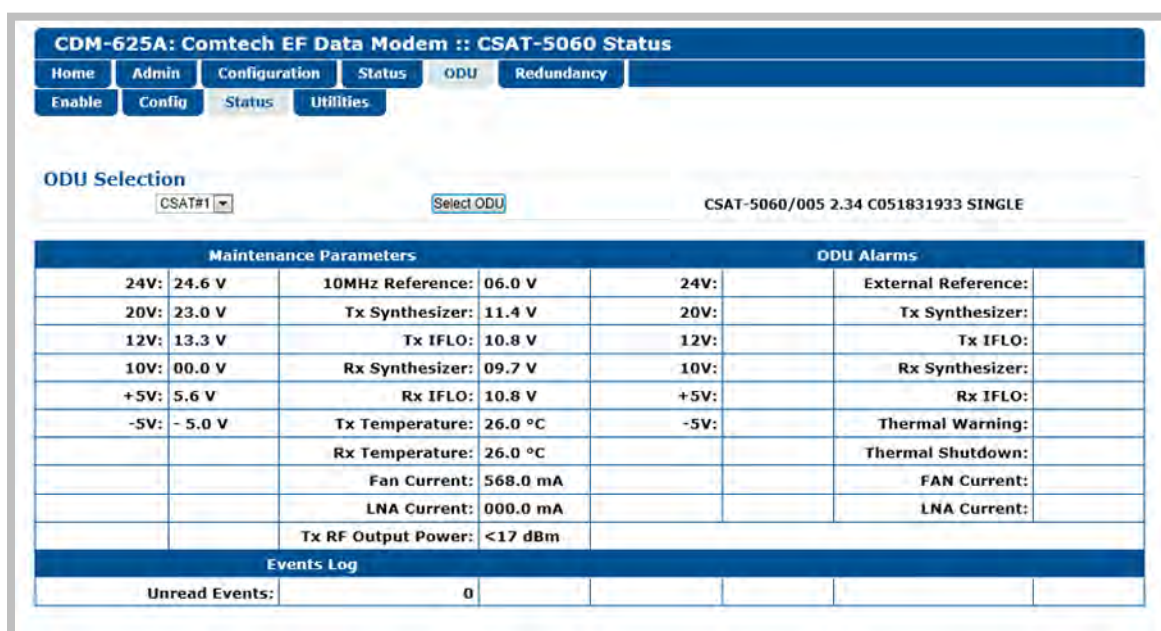

Figure 10-11. ODU | Status page (CSAT-5060)

ODU Selection

If you use ODUs in redundancy, you may toggle this page between the Online and Offline units. Use the drop-down list to select **CSAT #1** or **CSAT #2**, and then click **[Select ODU]**. A message identifies the currently active unit as '**ONLINE**' in the right-hand column of this section.

10.4.2.4.3.2 ODU | Status (KST-2000A/B)

Figure 10-12 shows the read-only 'ODU | Status' page as it appears when you configure the Comtech EF Data KST-2000A/B as the ODU.

CDM-625A: Comtech EF Data Modem :: KST-2000A/B Status			
<div style="display: flex; justify-content: space-between;"> Home Admin Configuration Status ODU Redundancy </div> <div style="display: flex; justify-content: space-between; margin-top: 5px;"> Enable Config Status Utilities </div>			
ODU Type KST-2000B		HPA Type OEM-SSPA	
Summary Fault Status		LNA	
FT		OK	
Common Equipment		AGC	
-7V PS	OK	Loop Convergence	OK
+7V PS	OK	Excess Power	OK
+12V PS	OK	Insufficient Power	FT
+17V PS	OK		
Up Converter		Down Converter	
Over Temperature	OK	Over Temperature	OK
L-Band Lock	OK	L-Band Lock	OK
Ku-Band Lock	OK	Ku-Band Lock	OK
Interprocessor Comms	OK	Interprocessor Comms	OK
Reference		HPA	
REF Source	INT	Over Temperature	OK
Oscillator	COLD	+9.75 V	OK
72M Lock	OK	-5 V	OK
Ext Ref Lock	NA	BIAS Voltage	OK
Ext Ref Phase_N	NA	Interprocessor Comms	OK
Ext Ref Range	NA		

Figure 10-12. ODU | Status page (KST-2000A/B)

ODU Type / HPA Type

The section identifies the installed equipment types.

The remainder of this page provides configuration and operational status information (e.g., **OK** / **FT = Fault**) for the following settings:

- Summary Fault Status
- LNA (Low-Noise Amplifier)
- Common Equipment
- AGC (Automatic Gain Control)
- Up Converter
- Down Converter
- Reference
- HPA (High Power Amplifier)

10.4.2.4.4 ODU | Utilities



The appearance of the 'ODU | Utilities' page adjusts to the type of ODU that is configured for operation with the CDM-625A.

Use this page to configure various ODU utility functions for either the Comtech EF Data **CSAT-5060** or the **KST-2000A/B** ODU.

10.4.2.4.4.1 ODU | Utilities (CSAT-5060)

Figure 10-13 shows the 'ODU | Utilities' page as it appears when you configure the Comtech EF Data **CSAT-5060** as the ODU.

Figure 10-13. ODU | Utilities page (CSAT-5060)

ODU Selection

If you use ODUs in redundancy, you may toggle this page between the Online and Offline units. Use the drop-down list to select **CSAT #1** or **CSAT #2**, and then click **[Select ODU]**. A message identifies the currently active unit as '**ONLINE**' in the right-hand column of this section.

Force 1:1 Switch

If you use ODUs in redundancy, and the selected unit is currently the **Online** unit, click **[Force 1:1 Switch]** to force a switchover so the unit will then be in **Offline** (standby) mode. The command is only valid for the **Online** unit in a 1:1 pair.

Recalibrate LNA Current

Click to recalibrate the LNA Current.

Redundancy Box Mode

Select **Automatic** or **Manual**, and then click [**Submit**].

ODU Date & Time

- Enter a date in the form DD/MM/YY (where DD = day [01 to 31], MM = month [01 to 12], and YY = year [00 to 99]).
- Enter a time using HH:MM:SS format (where HH = hour [00 to 23], MM = minutes [00 to 59], and SS = seconds [00 to 59]).

Click [**Enter Date/Time**] once you enter the desired date and time in this section.

ODU Stored Events

This section includes a scrollable window, which provides a visual record of the ODU stored events.

- **Unread Events** – Displays the total number of *unread* stored events in the scrollable events window. As stored event groups are displayed, this number decrements accordingly.
- **Read Next Five Events** – Click to buffer the next group of five stored events into the scrollable events window.
- **Clear Stored Events** – Click to wipe clean the stored events log.
- **Initialize Events Pointer** – Click to reset the log's internal pointer.

Click [**Submit**] to save.

10.4.2.4.4.2 ODU | Utilities (KST-2000A/B)

Figure 10-14 shows the read-only 'ODU | Utilities' page as it appears when you configure the Comtech EF Data KST-2000A/B as the ODU.

	Assembly Number	Serial Number	Firmware Number	Firmware Version
M&C	8816-1C	000000000	0303-1C	01.01.04
Up Converter	7210-1E	031573173	7085-1D	01.01.05
Down Converter	7206-1A	031583144	7087-1C	01.01.03
HPA	xxxx-xx	xxxxxxxxxx	xxxx-xx	xx.xx.xx

Figure 10-14. ODU | Utilities page (KST-2000A/B)

ODU Type / HPA Type

This section identifies the installed equipment types.

The remainder of this page identifies the configured ODU chassis' installed component assembly numbers and serial numbers, and firmware numbers and versions.

10.5 ODU Operations via the CDM-625A Telnet Command Line Interface (CLI)



Chapter 9. TELNET COMMAND LINE INTERFACE (CLI) OPERATION

The Telnet Command Line Interface (referred to hereafter as the Telnet CLI or the CLI) (**Figure 10-15**) is an Ethernet-based user menu system for the CDM-625A Advanced Satellite Modem equipped with an **installed and enabled** optional IP Packet Processor card. The CLI facilitates configuration, monitoring, and control of a CSAT-5060 Transceiver (ODU), installed in standalone or 1:1 Redundancy configurations, using a user-supplied terminal emulator.



- 1) The CDM-625A Telnet Command Line Interface (CLI) is accessible only when the optional IP Packet Processor is **installed and enabled**.
- 2) The CDM-625A Telnet CLI uses Telnet TCP Port **107**. Be sure to specify this port when configuring your terminal emulator for CLI operation.
- 3) For best results Comtech EF Data recommends PuTTY or Tera Term as the preferred terminal emulators.
- 4) The Telnet CLI's Remote Access Mode must be set to [Ethernet] in order to use the Telnet CLI for ODU operations.

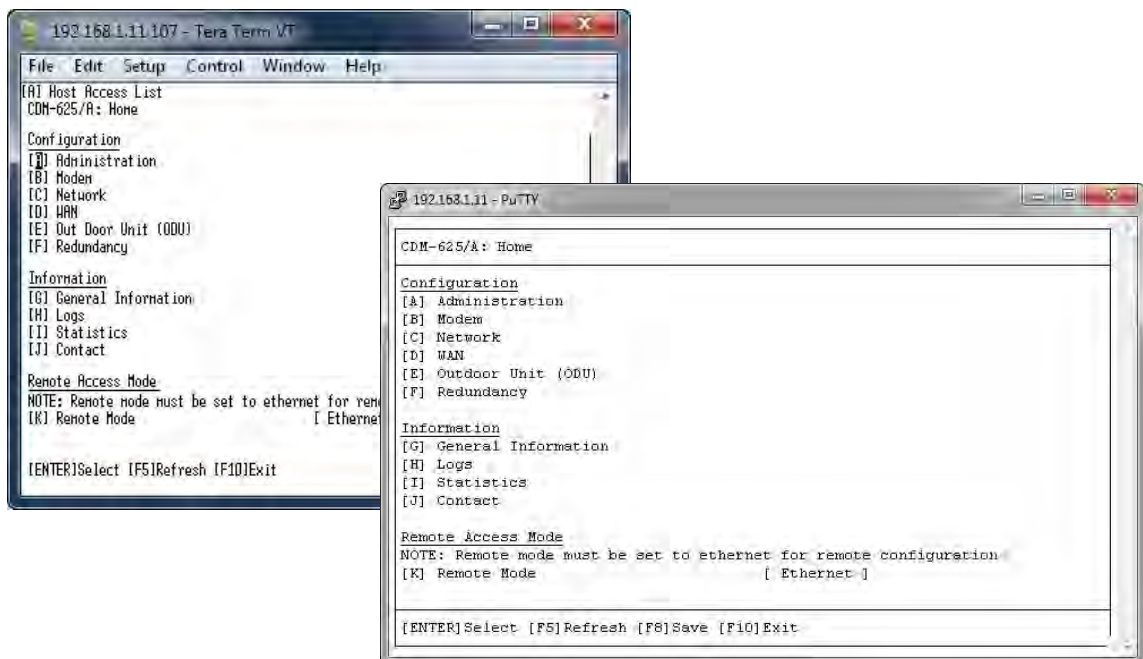

(LEFT) Tera Term CLI Example

(RIGHT) PuTTY CLI Example

Figure 10-15. CDM-625A Telnet Command Line Interface (CLI)

10.5.1 ODU Operations using the Telnet CLI



- 1) **ODU Comms must be Enabled, and the CDM-625A must be configured for 70/140 MHz operation in order to fully use the Telnet CLI ODU menus.**
- 2) **The Comtech EF Data KST-2000A/B Transceiver and LPOD Amplifier / Block Up Converter are not supported by the Telnet CLI at this time.**

10.5.1.1 Home (Main) Menu

```

CDM-625/A: Home
-----
Configuration
[A] Administration
[B] Modem
[C] Network
[D] WAN
[E] Outdoor Unit (ODU)
[F] Redundancy

Information
[G] General Information
[H] Logs
[I] Statistics
[J] Contact

Remote Access Mode
NOTE: Remote mode must be set to ethernet for remote configuration
[K] Remote Mode                [ Ethernet ]

-----
[ENTER] Select [F5] Refresh [F8] Save [F10] Exit
    
```

The **Home Menu** serves as the CLI's primary navigation page. Press the 'E' hot key to access the ODU submenus.

Hot Key	Description	Function
A	Administration	Access administrative configuration submenu
B	Modem	Access modem configuration submenu
C	Network	Access network configuration submenu
D	WAN	Access WAN configuration submenu
E	Outdoor Unit (ODU)	Access ODU comms, CSAT-5060 configuration submenus
F	Redundancy	Access 1:1 or 1:N redundancy configuration submenu
G	General Information	Enter alphanumeric Circuit ID; view read-only CDM-625A operations information screens
H	Logs	Access Base Modem and Packet Processor stored events and statistics logs, alarms control submenus
I	Statistics	Access CDM-625A operational statistics submenus
J	Contact	View read-only Customer Support contact information screen
K	Remote Mode	Open the Remote Access Mode setting

10.5.1.2 Home > Outdoor Unit (ODU) Submenu

After configuring the CDM-625A for 70/140 MHz operation, you may use the '**ODU** (Outdoor Unit)' pages to control and monitor the CSAT-5060 Outdoor Unit that is connected via FSK to the CDM-625A.

CDM-625/A: Home > Outdoor Unit (ODU)
[A] ODU Comms Enabled [Disabled] [B] CSAT-5060
[ENTER]Select [ESC]Back [F5]Refresh [F8]Save [F10]Exit

Open the **Outdoor Unit (ODU)** submenu from the **Home** menu. This submenu contains the following options:

Hot Key	Dialog Window	Option Entry
A	ODU Comms Enabled	Use the ↑↓ arrow keys to select Disabled or Enabled
B	CSAT-5060	Open the CSAT-5060 submenu – See Sect. 10.5.1.2.1

Press a hot key to open the dialog window or the submenu. Otherwise, press **[ESC]** to return to the **Home** submenu.

10.5.1.2.1 Home > Outdoor Unit (ODU) > CSAT-5060 Submenu

```

CDM-625/A: Home > Outdoor Unit (ODU) > CSAT-5060

[A] Select                               [ Csat1 ]

[B] Up Converter Settings (1/2)
[C] Up Converter Settings (2/2)
[D] Down Converter Settings (1/2)
[E] Down Converter Settings (2/2)
[F] Unit Settings (1/2)
[G] Unit Settings (2/2)
[H] LNA Settings
[I] Status
[J] Logs
[K] Redundancy
[L] Utilities

[ENTER]Select [ESC]Back [F5]Refresh [F8]Save [F10]Exit
  
```

Open the nested **CSAT-5060** submenu from the **Outdoor Unit (ODU)** submenu. This submenu contains the following options:

Hot Key	Dialog Window	Option Entry	Sect.
A	Select	Use the ↑↓ arrow keys to select Csat1 or Csat2	N/A
B	Up Converter Settings (1/2)	Configure an Up Converter	10.5.1.2.1.1
C	Up Converter Settings (2/2)		
D	Down Converter Settings (1/2)	Configure a Down Converter	10.5.1.2.1.2
E	Down Converter Settings (2/2)		
F	Unit Settings (1/2)	Configure an ODU	10.5.1.2.1.3
G	Unit Settings (2/2)		
H	LNA Settings	Configure a Low Noise Amplifier	10.5.1.2.1.4
I	Status	Review ODU Status Information	10.5.1.2.1.5
J	Logs	Review and manage Event Logs	10.5.1.2.1.6
K	Redundancy	Configure ODUs for 1:N Redundancy	10.5.1.2.1.7
L	Utilities	Set device time and date, review the unit's firmware version and serial number	10.5.1.2.1.8

Press a hot key to open a dialog window or configuration page. See the specified chapter section for further configuration options. Otherwise, press **[ESC]** to return to the **ODU** submenu.

10.5.1.2.1.1 Home > Outdoor Unit (ODU) > CSAT-5060 > Up Converter Settings 1/2, 2/2



After configuring the CDM-625A for L-Band operation, and when a Block Up Converter (BUC) is installed, you may use this page to configure BUC operating settings and to view the BUC operational status.

```

CDM-625/A: Home > Outdoor Unit (ODU) > CSAT-5060 > Up Converter Settings (1/2)

[A] Tx Frequency           [ 6425.000 ] MHz
[B] Tx Attenuation        [ 10.75 ] dB
[C] Tx Slope Mode         [ Calibrated ]
[D] Tx Slope Value        [ 0.0 ] units
Note: Slope value is for manual mode only

[ENTER] Select [ESC] Back [F5] Refresh [F8] Save [F10] Exit
    
```

```

CDM-625/A: Home > Outdoor Unit (ODU) > CSAT-5060 > Up Converter Settings (2/2)

[A] Tx Mute                [ Disabled ]
[B] Tx Amplifier           [ Off ]
[C] Tx Gain Offset         [ -3.75 ] dBm
Note: Gain Offset is for 1:1 Redundancy only
      Valid values are in increments of 0.25

[ENTER] Select [ESC] Back [F5] Refresh [F8] Save [F10] Exit
    
```

Open the **Up Converter Settings 1/2** page or the **Up Converter Settings 2/2** page from the nested **CSAT-5060** submenu.

The **Up Converter Settings 1/2** page contains the following options:

Hot Key	Dialog Window	Option Entry
A	Tx Frequency	Enter a value from 5845.000 to 6725.000 MHz
B	Tx Attenuation	Enter a value from 0.00 to 25.00 dB
C	Tx Slope Mode	Use the ↑↓ arrow keys to select Manual or Calibrated
D	Tx Slope Value	Enter a value from 0.0 to 1.0 units

The **Up Converter Settings 2/2** page contains the following options:

Hot Key	Dialog Window	Option Entry
A	Tx Mute	Use the ↑↓ arrow keys to select Disabled or Enabled
B	Tx Amplifier	Use the ↑↓ arrow keys to select Off or On
C	Tx Gain Offset	Enter a value from -4.00 to 0.00 dBm

Typical for either page, press a hot key to open a dialog window. Otherwise, press **[ESC]** to return to the nested **CSAT-5060** submenu.

10.5.1.2.1.2 Home > Outdoor Unit (ODU) > CSAT-5060 > Down Converter Settings 1/2, 2/2



After configuring the CDM-625A for L-Band operation, and when a Low Noise Block Down Converter (LNB) is installed, you may use this page to configure LNB operating settings and to view the LNB operational status.

```

CDM-625/A: Home > Outdoor Unit (ODU) > CSAT-5060 > Down Converter Settings (1/2)

[A] Rx Frequency           [ 4000.000 ] MHz
[B] Rx Attenuation         [ 10.00 ] dB
[C] Rx Slope Mode          [ Manual ]
[D] Rx Slope Value         [ 1.0 ] units
Note: Slope value is for manual mode only

[ENTER]Select [ESC]Back [F5]Refresh [F8]Save [F10]Exit
    
```

```

CDM-625/A: Home > Outdoor Unit (ODU) > CSAT-5060 > Down Converter Settings (2/2)

[A] Rx Mute                [ Disabled ]
[B] Rx Gain Offset         [ -0.25 ] dBm
Note: Gain Offset is for 1:1 Redundancy only
      Valid values are in increments of 0.25

[ENTER]Select [ESC]Back [F5]Refresh [F8]Save [F10]Exit
    
```

Open the **Down Converter Settings 1/2** page or the **Down Converter Settings 2/2** page from the nested **CSAT-5060** submenu.

The **Down Converter Settings 1/2** page contains the following options:

Hot Key	Dialog Window	Option Entry
A	Rx Frequency	Enter a value from 3400.000 to 4200.000 MHz
B	Rx Attenuation	Enter a value from 0.00 to 20.00 dB
C	Rx Slope Mode	Use the ↑↓ arrow keys to select Manual or Calibrated
D	Rx Slope Value	Enter a value from 0.0 to 1.0 units

The **Down Converter Settings 2/2** page contains the following options:

Hot Key	Dialog Window	Option Entry
A	Rx Mute	Use the ↑↓ arrow keys to select Disabled or Enabled
B	Rx Gain Offset	Enter a value from -4.00 to 0.00 dBm

Typical for either page, press a hot key to open a dialog window. Otherwise, press [ESC] to return to the nested **CSAT-5060** submenu.

10.5.1.2.1.3 Home > Outdoor Unit (ODU) > CSAT-5060 > Unit Settings 1/2, 2/2

```

CDM-625/A: Home > Outdoor Unit (ODU) > CSAT-5060 > Unit Settings (1/2)

[A] Unit Mute Mode                [ Muted After Freq Change ]
[B] Unit Auto Fault Recovery      [ Enabled ]
[C] Unit Cold Start               [ Disabled ]

[ENTER]Select [ESC]Back [F5]Refresh [F8]Save [F10]Exit
  
```

```

CDM-625/A: Home > Outdoor Unit (ODU) > CSAT-5060 > Unit Settings (2/2)

[A] Unit Ext Ref Fault Logic      [ Summary ]
[B] Unit Ref Osc Adjust          [ 255 ]
[C] Circuit ID                   [ ODU2 ]
Note: Circuit ID must be upper case

[ENTER]Select [ESC]Back [F5]Refresh [F8]Save [F10]Exit
  
```

Open the **Unit Settings 1/2** page or the **Unit Settings 2/2** page from the nested **CSAT-5060** submenu.

The **Unit Settings 1/2** page contains the following options:

Hot Key	Dialog Window	Option Entry
A	Unit Mute Mode	Use the ↑↓ arrow keys to select Unmuted After Freq Change or Muted After Freq Change
B	Unit Auto Fault Recovery	Use the ↑↓ arrow keys to select Disabled or Enabled
C	Unit Cold Start	Use the ↑↓ arrow keys to select Disabled or Enabled

The **Unit Settings 2/2** page contains the following options:

Hot Key	Dialog Window	Option Entry
A	Unit Ext Ref Fault Logic	Use the ↑↓ arrow keys to select No Summary or Summary
B	Unit Ref Osc Adjust	Enter a value from 0 to 255
C	Circuit ID	Enter an identifying label for the ODU here

Typical for either page, press a hot key to open a dialog window. Otherwise, press **[ESC]** to return to the nested **CSAT-5060** submenu.

10.5.1.2.1.4 Home > Outdoor Unit (ODU) > CSAT-5060 > LNA Settings

```

CDM-625/A: Home > Outdoor Unit (ODU) > CSAT-5060 > LNA Settings

[A] Unit LNA Current Window          [ 30 ]
[B] Unit LNA Current Source          [ Enabled When Online ]
[C] Unit LNA Fault Logic             [ Summary ]

[ENTER] Select [ESC] Back [F5] Refresh [F8] Save [F10] Exit
  
```

Open the **LNA Settings** page from the nested **CSAT-5060** submenu. This page contains the following options:

Hot Key	Dialog Window	Option Entry
A	Unit LNA Current Window	Enter a value as follows: <ul style="list-style-type: none"> • Range 1 – 20 to 50 • Range 2 – 99 to 99
B	Unit LNA Current Window	Use the ↑↓ arrow keys to select Disabled, Enabled, or Enabled When Online
C	Unit LNA Fault Logic	Use the ↑↓ arrow keys to select No Summary or Summary

Press a hot key to open a dialog window. Otherwise, press **[ESC]** to return to the nested **CSAT-5060** submenu.

10.5.1.2.1.5 Home > Outdoor Unit (ODU) > CSAT-5060 > Status

```

CDM-625/A: Home > Outdoor Unit (ODU) > CSAT-5060 > CSAT-5060 Status

Online State                               Offline

Maintenance Parameters
024.6023.0013.3000.0005.6-05.0011.4010.8009.7010.8006.0000.0577.0
26.017.5- 26.0

Unit Faults
0

Number Unread Events                       88

[ENTER] Select [ESC] Back [F5] Refresh [F8] Save [F10] Exit
  
```

Open the **read-only Status** page from the nested **CSAT-5060** submenu. This page provides the following information:

Item	Description
Online State	Identifies the unit as Online or Offline
Maintenance Parameters	Info needed
Unit Faults	Lists the current number of unit faults
Number Unread Events	Lists the number of unread events that are currently stored in the Events Log

Press **[ESC]** to return to the nested **CSAT-5060** submenu.

10.5.1.2.1.6 Home > Outdoor Unit (ODU) > CSAT-5060 > Logs

```

CDM-625/A: Home > Outdoor Unit (ODU) > CSAT-5060 > Logs

[A] Reset Event Pointer          [ No ]
[B] Clear Event Log             [ No ]

Stored Events
POWER OFF  IF 233428 120713
POWER ON   IF 234448 120713
POWER OFF  IF 000218 120813
POWER ON   IF 151857 120813
POWER OFF  IF 151900 120813

NOTE: Refresh to display next 5 events

[ENTER]Select [ESC]Back [F8]Save [F5]Refresh [F10]Exit
  
```

Open the **Logs** page from the nested **CSAT-5060** submenu. This page contains the following options:

Hot Key	Dialog Window	Option Entry
A	Reset Event Pointer	<i>Typical for either entry</i> – Use the ↑↓ arrow keys to select No or Yes
B	Clear Event Log	

Press a hot key to open a dialog window.

Stored Events: The page additionally provides a listing of the latest five stored events. Each event consists of a description, its time in HHMMSS format, and the date in DDMMYY format. Press **[F5]** to update this page with the next five events. Accessing event items in this manner causes the **Number Unread Events** count on the **CSAT-5060 > Status** page to decrement accordingly.

Press **[ESC]** to return to the nested **CSAT-5060** submenu.

10.5.1.2.1.7 Home > Outdoor Unit (ODU) > CSAT-5060 > Redundancy

```

CDM-625/A: Home > Outdoor Unit (ODU) > CSAT-5060 > Redundancy

[A] Unit Red Force Switch          [ No ]
[B] Unit Redundancy Mode          [ Manual ]

[ENTER] Select [ESC] Back [F5] Refresh [F8] Save [F10] Exit
  
```

Open the **Redundancy** page from the nested **CSAT-5060** submenu. Redundant ODU configuration options are as follows:

Hot Key	Dialog Window	Option Entry
A	Unit Red Force Switch	Use the ↑↓ arrow keys to select No or Yes
B	Unit Redundancy Mode	Use the ↑↓ arrow keys to select Manual or Auto

Press a hot key to open a dialog window. Otherwise, press **[ESC]** to return to the nested **CSAT-5060** submenu.

10.5.1.2.1.8 Home > Outdoor Unit (ODU) > CSAT-5060 > Utilities

```

CDM-625/A: Home > Outdoor Unit (ODU) > CSAT-5060 > CSAT-5060 Utilities

[A] Device Time                    [ 18:33:26 ]
[B] Device Date                    [ 01/01/14 ]
Model Number Software Ver         CSAT-5060/005  2.34
Unit Serial Number                 C000000000

[ENTER] Select [ESC] Back [F5] Refresh [F8] Save [F10] Exit
  
```

Open the **Utilities** page from the nested **CSAT-5060** submenu. This page contains the following options:

Hot Key	Dialog Window	Option Entry
A	Device Time	Enter a time in the form HH:MM:SS
B	Device Date	Enter a date in the form DD/MM/YY

The page additionally provides the model number, software version, and unit serial number of the recognized ODU.

Press a hot key to open a dialog window. Otherwise, press **[ESC]** to return to the nested **CSAT-5060** submenu.

Appendix A. CABLE DRAWINGS

A.1 Overview

The EIA-530 standard pinout provided on the CDM-625A Advanced Satellite Modem is becoming more popular in many applications. However, there are still many occasions – especially for existing EIA-422/449 and V.35 users – when a conversion is required. For these situations:

- **Figure A-1** depicts the cable required for EIA-530 -to- EIA-422/449 DCE conversion.
- **Figure A-2** depicts the cable required for EIA-530 -to- V.35 DCE conversion.
- **Figure A-3** depicts a standard EIA-232 cable for connection between the CDM-625A Rear Panel Remote Control port and any serial port on the User PC.



- 1) **The Electronic Industries Association (EIA) designations supersede the Recommended Standard (RS) designations. References to the old designations may be shown when depicting actual text (e.g., RS-232) displayed on Web Server pages, serial remote interfaces, Telnet Command Line Interfaces (CLIs), or unit rear panels. All other references in the manual refer to EIA designations.**
- 2) **All dimensions, where specified in the illustrations featured in this appendix, are in inches.**

A.1.1 EIA-530 to EIA-422/449 DCE Conversion Cable

Use this EIA-530-to-EIA-422/449 DCE Conversion Cable for connections between the CDM-625A and the user data.

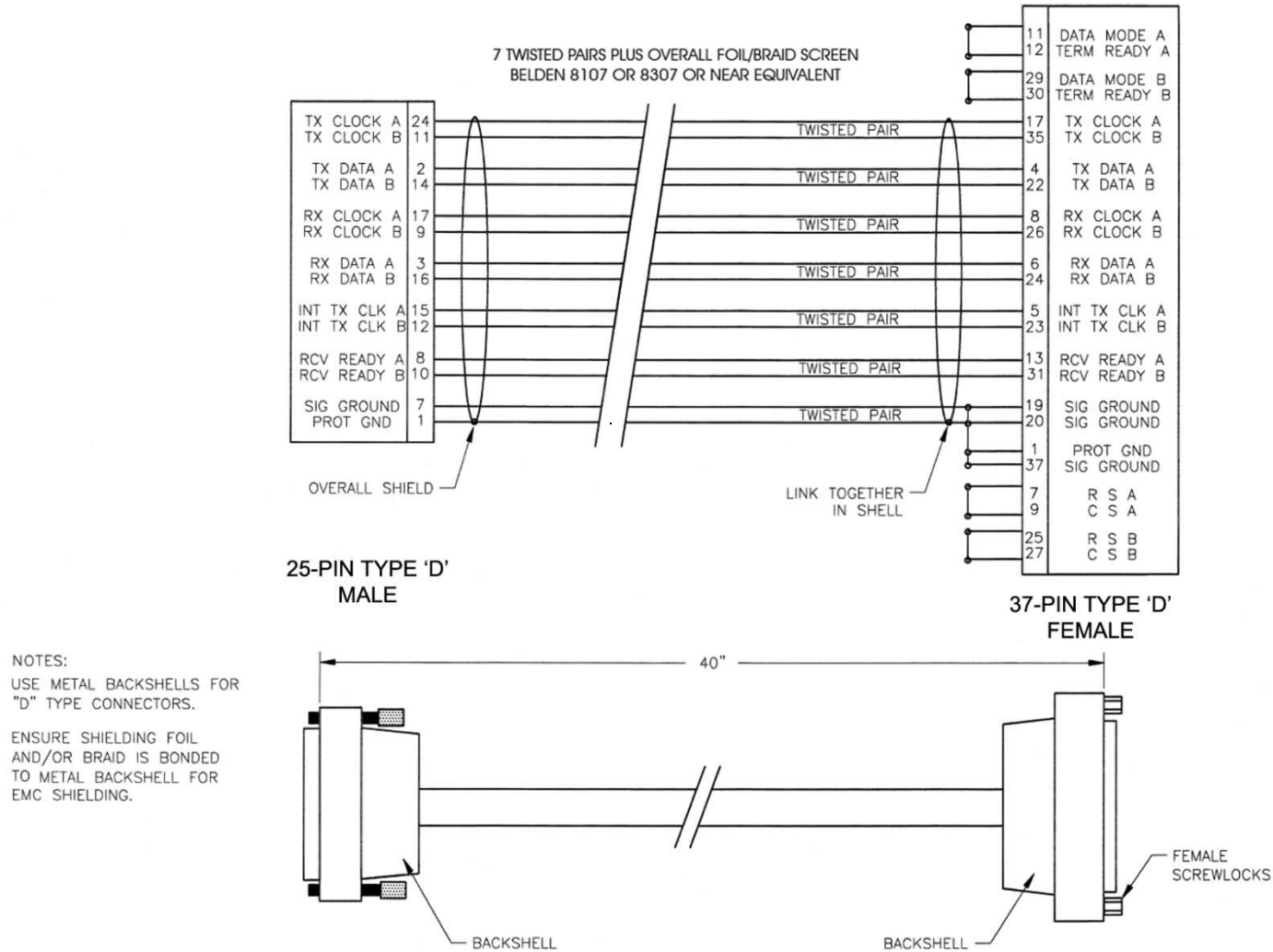
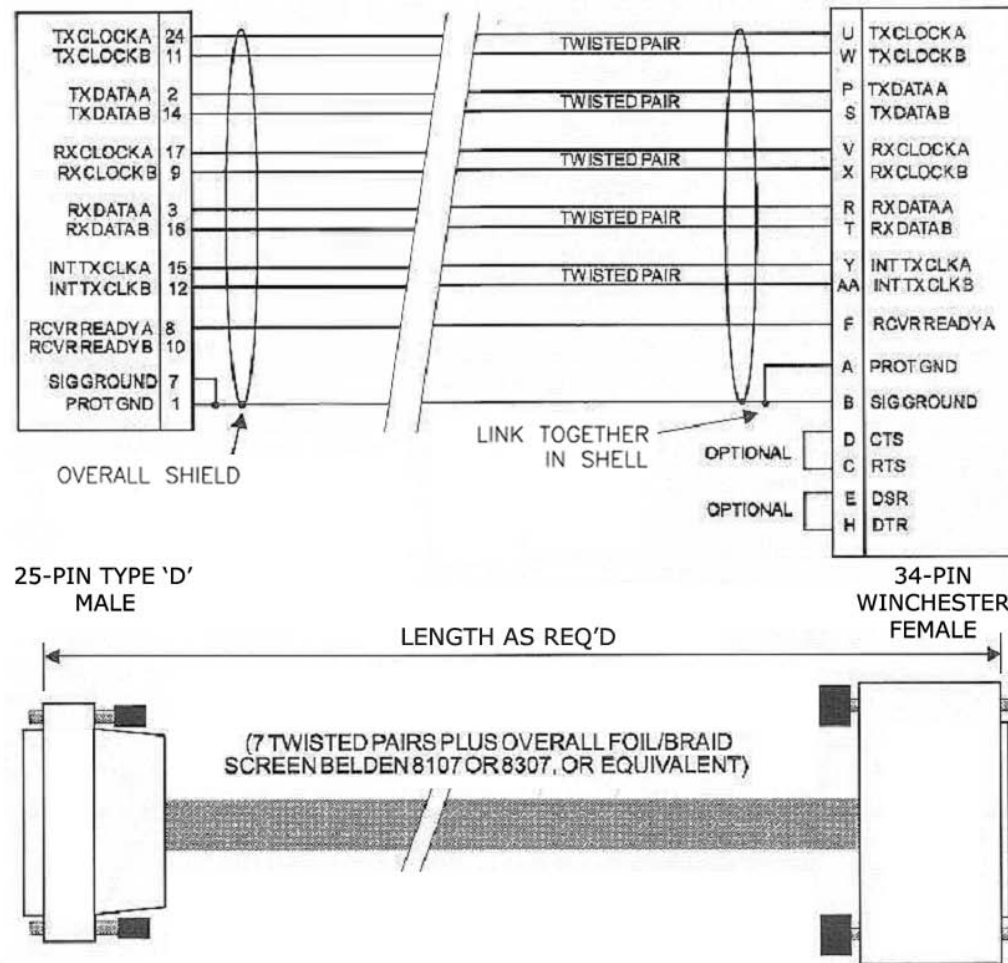

Figure A-1. EIA-530 to EIA-422/449 DCE Conversion Cable (CEFD P/N CA/WR0049)

A.1.2 EIA-530 to V.35 DCE Conversion Cable

Use this EIA-530 to V.35 DCE Conversion Cable for connections between the CDM-625A and the user data.



NOTES:
USE METAL BACKSHELLS FOR "D" TYPE CONNECTORS.
ENSURE SHIELDING FOIL AND/OR BRAID IS BONDED TO METAL BACKSHELL FOR EMC SHIELDING.

Figure A-2. EIA-530 to V.35 DCE Conversion Cable

A.1.3 EIA-232 Remote Control Cable

Use this EIA-232 Remote Control Cable for firmware updates in the absence of an Ethernet-based connection. You may also use this cable for serial-based M&C of the CDM-625A. Connect this cable from the CDM-625A Rear Panel “**Remote Control**” port to any User PC serial port.

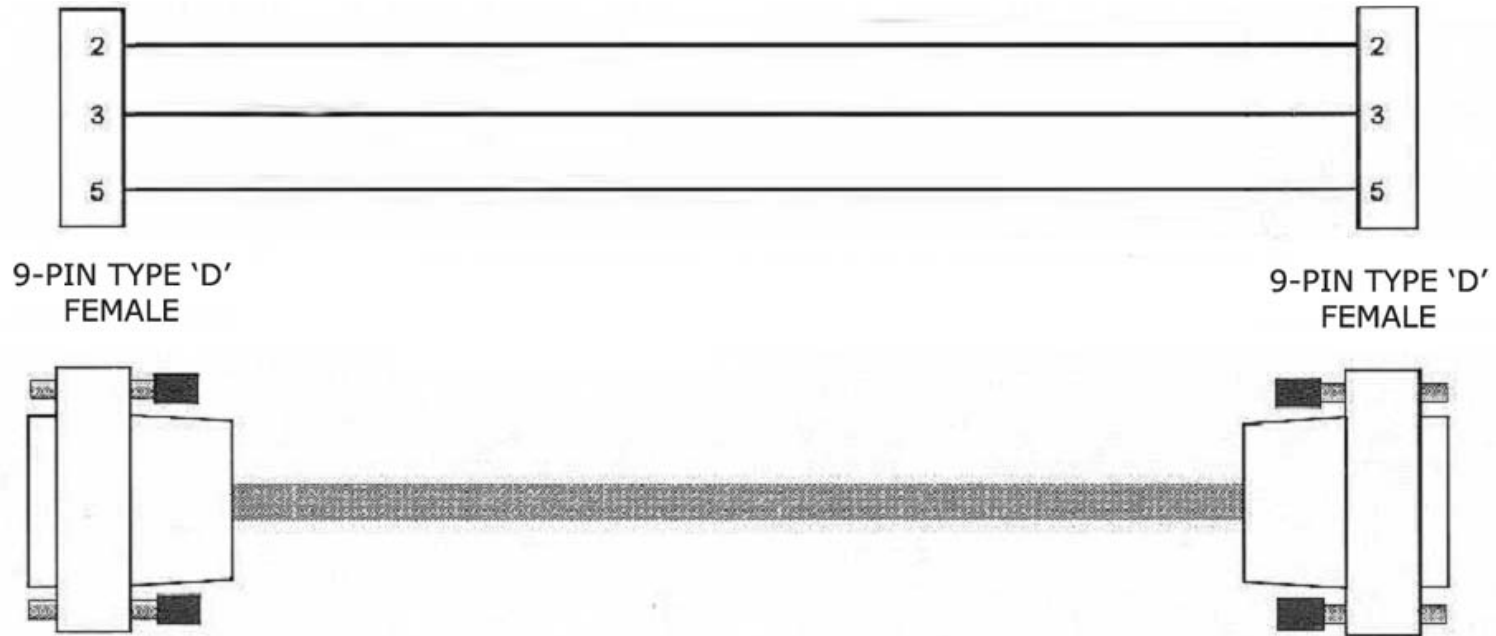

Figure A-3. EIA-232 Remote Control Cable (CDM-625A “Remote Control” Port to User PC 9-Pin Serial Port)

Appendix B. FEC (FORWARD ERROR CORRECTION) OPTIONS

B.1 FEC Overview

As standard, the CDM-625A Advanced Satellite Modem is equipped with four Forward Error Correction encoders/decoders – Viterbi, Sequential, concatenated Reed-Solomon and Trellis (which is available with the 8-PSK FAST option). The constraint lengths and encoding polynomials are not only Open Network compatible, but are also Closed Network compatible with the vast majority of existing modems from other manufacturers. Comtech EF Data has performed compatibility testing to ensure inter-operability.

Turbo Product Coding (**TPC**) and Low-Density Parity Check (**LDPC**) coding represent a significant development in the area of FEC. An option card, field upgradeable, combines LDPC and TPC together on one module.

While the performance of LDPC is exceptional in terms of coding gain, its higher latency is considered disadvantageous in some applications. For this reason, Comtech EF Data and Comtech AHA Enterprise Products Group have jointly developed a family of short-block LDPC codes, which we have called **VersaFEC**[®]. (The name VersaFEC is a trademark registered to Comtech AHA.) It is ideal for lower data rates that demand the shortest possible latency, and is available as a field upgradeable option card.

VersaFEC represents the best Forward Error Correction technology currently available, and is offered with a sufficient range of code rates and modulation types that link performance can be optimized under almost any conditions.

B.2 Viterbi

In the 1990s, the combination of convolutional coding and Viterbi decoding was an almost universal standard for satellite communications. The CDM-625A complies with the Intelsat IESS 308/309 standards for Viterbi decoding with a constraint length of seven. This is a *de facto* standard, even in a closed network environment, which means almost-guaranteed interoperability with other manufacturer’s equipment. It provides useful levels of coding gain, and its short decoding delay and error-burst characteristics make it particularly suitable for low data rate coded voice applications. It has a short constraint length, fixed at 7, for all code rates. (The constraint length is defined as the number of output symbols from the encoder that are affected by a single input bit.)

By choosing various coding rates (Rate 1/2, 3/4 or 7/8) you can trade off coding gain for bandwidth expansion. Rate 1/2 coding gives the best improvement in error rate, but doubles the transmitted data rate, and hence doubles the occupied bandwidth of the signal. Rate 7/8 coding, at the other extreme, provides the most modest improvement in performance, but only expands the transmitted bandwidth by 14%.

A major advantage of the Viterbi decoding method is that the performance is independent of data rate, and does not display a pronounced threshold effect (i.e., does not fail rapidly below a certain value of E_b/N_0). Note that, in BPSK mode, the CDM-625A only permits a coding rate of 1/2. Because the method of convolutional coding used with Viterbi, the encoder does not preserve the original data intact, and is called *non-systematic*.

Table B-1. Viterbi Decoding Summary

FOR	AGAINST
<ul style="list-style-type: none"> • Good BER performance – very useful coding gain. • Almost universally used, with <i>de facto</i> standards for constraint length and coding polynomials. • Shortest decoding delay (~100 bits) of any FEC scheme – good for coded voice, VOIP, etc. • Short constraint length produce small error bursts – good for coded voice. • No pronounced threshold effect – fails gracefully. • Coding gain independent of data rate. 	<p>Much higher coding gain possible with other methods.</p> <div style="display: flex; align-items: center;">  <p><u>NOT RECOMMENDED FOR NEW LINKS!</u></p> </div>

B.3 Sequential

Although the method of convolutional coding and Sequential decoding appears to be very similar to the Viterbi method, there are some fundamental differences. To begin with, the convolutional encoder is said to be *systematic* – it does not alter the input data, and the FEC overhead bits are simply appended to the data. Furthermore, the constraint length k is much longer (Rate 1/2, $k=36$. Rate 3/4, $k= 63$. Rate 7/8, $k=87$). This means that, when the decoding process fails (i.e., when its capacity to correct errors is exceeded), it produces a burst of errors which is in multiples of half the constraint length. An error distribution is produced which is markedly different to that of a Viterbi decoder; this gives rise to a pronounced threshold effect.

A Sequential decoder does not fail gracefully – a reduction in E_b/N_0 of just a few tenths of a dB can make the difference between acceptable BER and a complete loss of synchronization. The decoding algorithm itself, called the *Fano algorithm*, uses significantly more path memory – 4 kbps in this case – than the equivalent Viterbi decoder, giving rise to increased latency. Furthermore, a fixed computational clock is used to process input symbols and to search backwards and forwards in time to determine the correct decoding path.

At lower data rates there are sufficient number of computational cycles per input symbol to permit the decoding process to perform optimally. However, as the data rate increases, there are fewer cycles available, leading to a reduction in coding gain. This is clearly illustrated in the performance curves that follow. For data rates above ~ 1 Mbps, Viterbi should be considered the better alternative; the practical upper limit in this implementation is 2.048 Mbps.

Table B-2. Sequential Decoding Summary

FOR	AGAINST
Higher coding gain (1-2 dB) at lower data rates, compared to Viterbi.	<ul style="list-style-type: none"> • Pronounced threshold effect – does not fail gracefully in poor E_b/N_0 conditions. • Higher processing delay than Viterbi (~ 4 k bits) – not good for low-rate coded voice. • Upper data rate limit 2.048Mbps • Coding gain varies with data rate – favors lower data rates. • Much higher coding gain possible with other methods. <div style="display: flex; align-items: center;">  <p><u>NOT RECOMMENDED FOR NEW LINKS!</u></p> </div>

B.4 Reed-Solomon Outer Codec

The concatenation of an outer Reed-Solomon (RS) Codec with Viterbi decoder first became popular when it was introduced by Intelsat in the early 1990s. It permits significant improvements in error performance without significant bandwidth expansion. The coding overhead added by the RS outer Codec is typically around 10%, which translates to a 0.4 dB power penalty for a given link.

Reed-Solomon codes are block codes – as opposed to Viterbi, which is convolutional; in order to be processed correctly, the data must be framed and de-framed. Additionally, RS codes are limited in how well they can correct errors that occur in bursts. This, unfortunately, is the nature of the uncorrected errors from Viterbi decoders, which produce clusters of errors that are multiples of half the constraint length. For this reason, the data must be interleaved following RS encoding, and is then de-interleaved prior to decoding. This ensures that a single burst of errors leaving the Viterbi or Sequential decoder is spread out over a number of interleaving frames, so errors entering the RS decoder do not exceed its capacity to correct those errors. In the case of the CDM-625A, different RS code rates are used according to the mode of operation: **Closed Network Modes** and **Open Network Modes**.

B.4.1 Closed Network Modes

A 220,200 code is used in transparent closed network modes, and a 200,180 code is used in framed (EDMAC) modes. (220,200 means that data is put into blocks of 220 bytes, of which 200 bytes are data, and 20 bytes are FEC overhead.) These two codes were chosen because they fit well into Comtech EF Data’s clock generation scheme, and they have almost identical coding gain. There is also a 225, 205 code available that it compatible with legacy EF Data modems. When Viterbi decoding is used as the primary FEC, an interleaver depth of 4 is used. The increase in coding gain is at the expense of delay. The interleaving/de-interleaving delay and the delay through the decoder itself can be as high as 25 kbits. At very low data rates, this equates to several seconds, making it highly unsuitable for voice applications. Additionally, the de-interleaver frame synchronization method can add significantly to the time taken for the demodulator to declare acquisition.

B.4.2 Open Network Modes

Code Rate	Mode
219, 201	Standard IESS-308 E1, and IESS-310 mode
225, 205	Standard IESS-308 T1
194, 178	Standard IESS-308 T2/E2
126, 112	Standard IESS-309 modes

A characteristic of concatenated RS coding is the very pronounced threshold effect. For any given modem design, there will be a threshold value of E_b/N_0 below which the demodulator cannot stay synchronized. This may be due to the carrier-recovery circuits, or the synchronization threshold of the primary FEC device, or both. In the CDM-625A, and Rate 1/2 operation, this threshold is around 4 dB E_b/N_0 . Below this value, operation is not possible, but above this value, the error performance of the concatenated RS system produces exceptionally low error rates for a very small increase in E_b/N_0 .



CAUTION – You must take care not to operate the demodulator near its sync threshold. Small fluctuations in E_b/N_0 may cause total loss of the link and, as a result, the demodulator will need to re-acquire the signal.

Table B-3. Concatenated RS Coding Summary

FOR	AGAINST
<ul style="list-style-type: none"> • Exceptionally good BER performance – several orders of magnitude improvement in link BER under given link conditions. • Very small additional bandwidth expansion. 	<ul style="list-style-type: none"> • Very pronounced threshold effect – does not fail gracefully in poor E_b/N_0 conditions. Additional coding overhead actually degrades sync threshold, and reduces link fade margin. • Significant processing delay (~25 kbps) – not good for voice or IP applications. • Adds to demod acquisition time. • Higher coding gain methods with much lower latency now available. <div style="display: flex; align-items: center;"> <p><u>NOT RECOMMENDED FOR NEW LINKS!</u></p> </div>

B.5 Trellis Coding (FAST Option)

In the other FEC methods described here, the processes of coding and modulation are independent – the FEC codec has no knowledge of, or interaction with the modulator. However, there are schemes in which the coding and modulation are combined together, where the encoder places FEC symbols in a precise manner into the signal constellation. This can yield an overall improvement in performance, and is used in higher-order modulation schemes, such as 8-PSK, 16-PSK, 16-QAM, etc.

When convolution coding is used, the overall *coded modulation* approach is referred to as Trellis Coded Modulation (TCM). Ungerboeck was an early pioneer and developed optimum mapping and decoding schemes. However, the decoding scheme was seen as complex and expensive, and Qualcomm Inc. developed a variation on the theme that uses a Viterbi decoder at the core, surrounded by adjunct processing. The scheme, called *pragmatic Trellis Coded Modulation*, is able to achieve performance very close to the optimum Ungerboeck method, but with far less complexity.

As more and more high power transponders are put in to service, Intelsat recognized that the transponders are no longer *power limited*, but *bandwidth limited*. In order to maximize transponder capacity, 8-PSK was looked at as a method of reducing the occupied bandwidth of a carrier, and Qualcomm’s pragmatic TCM, at Rate 2/3, was adopted.

A Rate 2/3 8-PSK/TCM carrier occupies only 50% of the bandwidth of a Rate 1/2 QPSK carrier. However, the overall coding gain of the scheme is not adequate by itself, so Intelsat’s IESS-310 specification requires that the scheme be concatenated with an outer RS codec. When combined, there is a threshold value of E_b/N_0 of around 6 dB and, above approximately 7 dB, the bit error rate is better than 1×10^{-8} .

The detractions of the concatenated RS approach apply here also, along with more stringent requirements for phase noise and group delay distortion – the natural consequences of the higher-order modulation.

The CDM-625A fully implements the IESS-310 specification at data rates up to 20 Mbps. In accordance with the specification, the RS outer code can be disabled. Performance curves for both cases are shown in the following figures.

Table B-4. 8-PSK/TCM Coding Summary

FOR	AGAINST
Exceptionally bandwidth efficient compared to QPSK.	<ul style="list-style-type: none"> • Needs concatenated RS outer codec to give acceptable coding gain performance. • Demod acquisition threshold much higher than for QPSK. • 8-PSK is more sensitive to phase noise and group delay distortion than QPSK. <div style="text-align: center; margin-top: 10px;">  NOT RECOMMENDED FOR NEW LINKS! </div>

B.6 Turbo Product Codec (Hardware Option)

Turbo coding is an FEC technique developed within the last few years, which delivers significant performance improvements compared to more traditional techniques. Two general classes of Turbo Codes have been developed, Turbo Convolutional Codes (TCC), and Turbo Product Codes (TPC, a block coding technique). Comtech EF Data has chosen to implement an FEC codec based on TPC. A Turbo Product Code is a 2 or 3 dimensional array of block codes. Encoding is relatively straightforward, but decoding is a very complex process requiring multiple iterations of processing for maximum performance to be achieved.

Unlike the popular method of concatenating an RS codec with a primary FEC codec, Turbo Product Coding is an entirely stand-alone method. It does not require the complex interleaving/de-interleaving of the RS approach, and consequently, decoding delays are significantly reduced. Furthermore, the traditional concatenated RS schemes exhibit a very pronounced threshold effect – a small reduction in E_b/N_0 can result in total loss of demod and decoder synchronization. TPC does not suffer from this problem – the demod and decoder remain synchronized down to the point where the output error rate becomes unusable. This is considered to be a particularly advantageous characteristic in a fading environment. Typically, in QPSK, 8-PSK and 16-QAM TPC modes the demod and decoder can remain synchronized **2 – 3 dB below** the Viterbi/Reed-Solomon or TCM cases.

B.7 TPC and Low Density Parity Check (LDPC) Coding

B.7.1 Overview

In the past few years there has been an unprecedented resurgence in interest in Forward Error Correction (FEC) technology. The start of this new interest has its origins in the work done by Claude Berrou *et al*, and the 1993 landmark paper, *Near Shannon Limit Error Correcting Coding and Decoding – Turbo Codes*. FEC is considered an essential component in all wireless and satellite communications in order to reduce the power and bandwidth requirements for reliable data transmission.

Claude Shannon, considered by many to be the father of modern communications theory, first established the concept of Channel Capacity in his 1948 paper *A Mathematical Theory of Communication*. This places an absolute limit on how fast it is possible to transmit error-free data within a channel of a given bandwidth, and with given noise conditions within that channel. He concluded that it would only be possible to approach this limit through the use of source encoding – what is familiar today as Forward Error Correction.

Shannon postulated that if it were possible to store every possible message in the receiver, finding the stored message that most closely matched the incoming message would yield an optimum decoding method. However, for all but the shortest bit sequences, the memory required for this, and the time taken to perform the comparisons, makes this approach impractical. For all practical purposes, the memory requirement and the decoding latency become infinite.

For many years, there were few advances in the quest to approach the Shannon Limit. The Viterbi algorithm heralded a major step forward, followed in the early 1990s by the concatenation of a Viterbi decoder with Reed-Solomon hard-decision block codes. It remained clear, however, that the Shannon Limit was still an elusive target.

Berrou's work on Turbo Codes showed, through the use of an ingeniously simple approach (multiple, or *iterative* decoding passes) that it is possible to achieve performance close to the Shannon Limit. Berrou's early work dealt exclusively with iteratively-decoded convolutional codes (Turbo Convolutional Coding, or TCC), but in time the iterative approach was applied to a particular class of block codes called Product Codes – hence Turbo Product Coding (TPC). TPC exhibits inherently low decoding latency compared with TCC, and so is considered much more desirable for 2-way, interactive satellite communications applications.

In August 1999, Comtech became the first company in the world to offer satellite modems that incorporate TPC. Since its inception, Comtech has continued to develop and refine its implementation of TPC in its products, and now offers a comprehensive range of code rates (from Rate 5/16 to Rate 0.95) and modulations (from BPSK to 16-QAM). However, in the past few years, as part of the general interest in Turbo coding, a third class of Turbo coding has emerged: Low Density Parity Check Codes (LDPC).

LDPC is more like TPC than TCC in that it is an iteratively-decoded block code. Gallager first suggested this in 1962 but, at the time, the implementation complexity was considered to be

too great; for decades, it remained of purely academic interest. Further interest in LDPC was stimulated in 2003, when the Digital Video Broadcasting (DVB) committee adopted LDPC codes (proposed by Hughes Network Systems) as the basis for the new DVB-S2 standard. Now, however, with silicon gates being cheap, plentiful and fast, an LDPC decoder can easily be accommodated in a large Field Programmable Gate Array (FPGA) device.

The LDPC method on its own produces an undesirable ‘flaring’ in the Bit Error Rate (BER) vs. E_b/N_0 characteristic, and for this reason it is desirable to concatenate a short BCH code with LDPC. This concatenation produces almost vertical BER vs. E_b/N_0 curves, as can be seen in the performance graphs that are presented later. In order to take full advantage of the coding gain increase that LDPC provides, it became necessary to find an alternative to 8-PSK. Comtech EF Data has therefore developed an 8-QAM approach that permits acquisition and tracking at much lower values of E_b/N_0 than 8-PSK. Comtech EF Data’s implementation of 8-QAM is the subject of a U.S. Patent, granted in 2007.

Comtech EF Data chose the CDM-600 platform as the first satellite modem in which to implement both LDPC and 8-QAM, and the CDM-625A includes a newer technology version of the original design.

B.7.2 TPC vs. LDPC

Is LDPC better than TPC? The answer must be ‘sometimes, but not always’, and there are issues such as latency that must be taken into consideration. **Figure B-1** graphs the performance of various TPC and LDPC modes relative to the Shannon Limit – the Channel Capacity is shown for both QPSK and 8-PSK. Error free transmission is not possible for values of spectral efficiency (capacity) vs. E_b/N_0 above these limit curves. The horizontal distance to the limit provides a metric of overall performance.

It can be seen from this graph that, for Code Rates above 3/4, Comtech EF Data’s TPCs are very close (1-1.5 dB) to the Shannon Limit. However, at 3/4 and below, LDPCs are performing 0.7-1.2 dB better than TPCs.

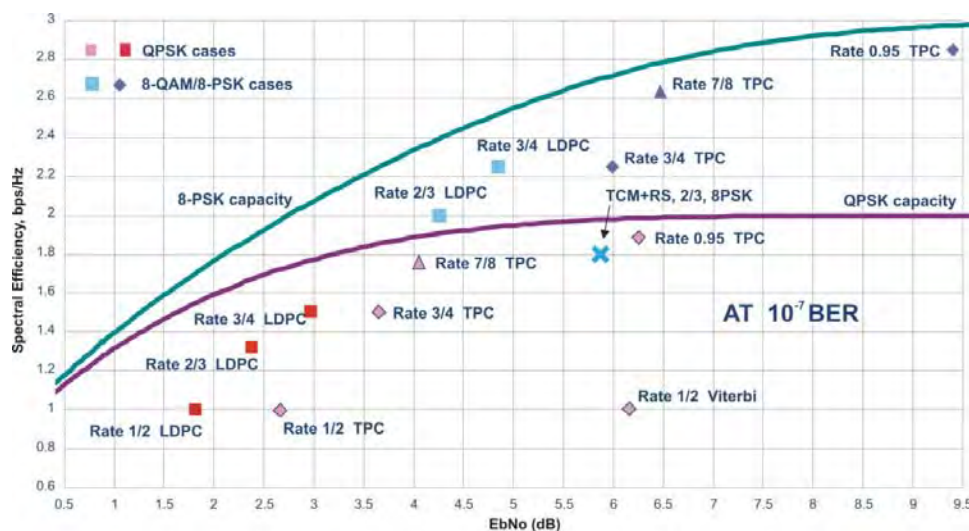

Figure B-1. TPC & LDPC Modes Performance (Relative to Shannon Limit)

It is clear that, in order to provide the best possible performance over the range of code rates from 1/2 to 0.95, both an LDPC and a TPC codec need to be offered.

In order to meet this requirement, Comtech EF Data has developed a combination LDPC/TPC Codec module that can be added to the CDM-625A Modem. **Table B-5** outlines the operating modes provided by this module.

Table B-5. Available TPC/LDPC Modes

Mode	Code Rate/Modulation	Lower Data Rate Limit (kbps)	Upper Data Rate Limit (kbps)
TPC	Rate 21/44 BPSK (aka 1/2)	18.0	5965.9
	Rate 5/16 BPSK	18.0	3906.2
	Rate 21/44 QPSK, OQPSK (aka 1/2)	18.0	11931.8
	Rate 3/4 QPSK, OQPSK	27.0	18750.0
	Rate 3/4 8-PSK , 8-QAM	40.0	25000.0
	Rate 3/4 16-QAM	54.0	25000.0
	Rate 7/8 QPSK, OQPSK	31.5	21875.0
	Rate 7/8 8-PSK , 8-QAM	48.0	25000.0
	Rate 7/8 16-QAM	63.0	25000.0
	Rate 0.95 QPSK, OQPSK (aka 17/18)	34.2	23611.1
	Rate 0.95 8-PSK , 8-QAM (aka 17/18)	52.0	25000.0
LDPC	Rate 1/2 BPSK	18.0	6250.0
	Rate 1/2 QPSK, OQPSK	18.0	12500.0
	Rate 2/3 QPSK, OQPSK	24.0	16666.6
	Rate 2/3 8-PSK , 8-QAM	36.0	25000.0
	Rate 3/4 QPSK, OQPSK	27.0	18750.0
	Rate 3/4 8-PSK , 8-QAM	40.5	25000.0
	Rate 3/4 16-QAM	54.0	25000.0

This LDPC/TPC codec module may be installed in any existing CDM-625A as a simple field upgrade, or it can be pre-installed in new modems ordered from the factory. It also requires the appropriate FAST codes for enabling operation beyond the base data rate limit of 5 Mbps.

Contact Comtech EF Data Product support for pricing and delivery information.

Table B-6 compares all TPC and LDPC modes available in Comtech EF Data’s CDM-625A, and shows E_b/N_0 performance and spectral efficiency (occupied bandwidth) for each case. This information will be of particular interest to satellite operators wishing to simultaneously balance transponder power and bandwidth. The large number of modes offered will permit, in the majority of cases, significant power and/or bandwidth savings when compared with existing schemes such as concatenated Viterbi/Reed-Solomon, or the popular 8-PSK/Trellis/Reed-Solomon (Intelsat IESS-310).

Table B-6. Comparison of all Comtech EF Data TPC/LDPC Modes (CDM-625A with TPC/LDPC Codec)

Mode	Eb/No at BER = 10 ⁻⁶ (typical)	Eb/No at BER = 10 ⁻⁸ (typical)	Spectral Efficiency (bps/Hz)	Symbol Rate	Occupied * Bandwidth for 1 Mbps Carrier
<i>QPSK Rate 1/2 Viterbi **</i>	5.5 dB	6.8 dB	1.00 bps/Hz	1.0 x bit rate	1190 kHz
BPSK Rate 1/2 LDPC	1.7 dB	1.9 dB	0.50 bps/Hz	2.0 x bit rate	2380 kHz
BPSK Rate 21/44 TPC	2.8 dB	3.0 dB	0.48 bps/Hz	2.1 x bit rate	2493 kHz
BPSK Rate 5/16 TPC	2.4 dB	3.0 dB	0.31 bps/Hz	3.2 x bit rate	3808 kHz
QPSK/OQPSK Rate 1/2 LDPC	1.7 dB	1.9 dB	1.00 bps/Hz	1.0 x bit rate	1190 kHz
QPSK/OQPSK Rate 21/44 TPC	2.8 dB	3.3 dB	0.96 bps/Hz	1.05 x bit rate	1246 kHz
QPSK/OQPSK Rate 2/3 LDPC	2.1 dB	2.4 dB	1.33 bps/Hz	0.75 x bit rate	892 kHz
QPSK/OQPSK Rate 3/4 LDPC	2.7 dB	2.9 dB	1.50 bps/Hz	0.67 x bit rate	793 kHz
QPSK/OQPSK Rate 3/4 TPC	3.4 dB	4.0 dB	1.50 bps/Hz	0.67 x bit rate	793 kHz
QPSK/OQPSK Rate 7/8 TPC	4.2 dB	4.3 dB	1.75 bps/Hz	0.57 x bit rate	678 kHz
QPSK/OQPSK Rate 0.95 TPC	6.0 dB	6.5 dB	1.90 bps/Hz	0.53 x bit rate	626 kHz
<i>8-PSK Rate 2/3 TCM ** and RS (IESS-310)</i>	5.6 dB	6.2 dB	1.82 bps/Hz	0.56 x bit rate	666 kHz
8-QAM Rate 2/3 LDPC	4.3 dB	4.6 dB	2.00 bps/Hz	0.50 x bit rate	595 kHz
8-QAM Rate 3/4 LDPC	5.3 dB	5.5 dB	2.25 bps/Hz	0.44 x bit rate	529 kHz
8-PSK/8-QAM Rate 3/4 TPC	6.1 dB	6.7 dB	2.25 bps/Hz	0.44 x bit rate	529 kHz
8-PSK/8-QAM Rate 7/8 TPC	6.7 dB	6.9 dB	2.62 bps/Hz	0.38 x bit rate	453 kHz
8-PSK/8-QAM Rate 0.95 TPC	9.2 dB	10.2 dB	2.85 bps/Hz	0.35 x bit rate	377 kHz
16-QAM Rate 3/4 LDPC	6.7 dB	6.8 dB	3.00 bps/Hz	0.33 x bit rate	396 kHz
16-QAM Rate 3/4 TPC	7.4 dB	8.1 dB	3.00 bps/Hz	0.33 x bit rate	396 kHz
16-QAM Rate 7/8 TPC	7.9 dB	8.1 dB	3.50 bps/Hz	0.28 x bit rate	340 kHz
<i>16-QAM Rate 3/4 ** Viterbi/Reed-Solomon</i>	7.5 dB	8.0 dB	2.73 bps/Hz	0.37 x bit rate	435 kHz
<i>16-QAM Rate 7/8 ** Viterbi/Reed-Solomon</i>	9.0 dB	9.5 dB	3.18 bps/Hz	0.31 x bit rate	374 kHz

* The occupied bandwidth is defined at the width of the transmitted spectrum taken at the -10 dB points on the plot of power spectral density. This equates to 1.19 x symbol rate for the CDM-625A transmit filtering.

** Included for comparative purposes

B.7.3 End-to-End Processing Delay

In many cases, FEC methods that provide increased coding gain do so at the expense of increased processing delay. However, with TPC, this increase in delay is very modest. **Table B-7** shows the processing delays for the CDM-625A's major FEC types, including the three TPC modes.

Table B-7. TPC/LDPC Processing Delay Comparison

FEC Mode (64 kbps data rate)		End-to-end delay (ms)
Viterbi	Rate 1/2	9
	Rate 1/2 + Reed Solomon	266
Sequential	Rate 1/2	74
	Rate 1/2 + Reed Solomon	522
Turbo Product Coding	Rate 3/4	47
	Rate 21/44	41
	Rate 5/16	69
	Rate 7/8	245 *
	Rate 0.95	69
LDPC Coding	Rate 1/2	198
	Rate 2/3, O/QPSK	234
	Rate 2/3, 8-PSK, 8-QAM	350
	Rate 3/4, O/QPSK	248
	Rate 3/4, 8-PSK, 8-QAM, 16-QAM	395

***A larger block is used for the Rate 7/8 code, which increases decoding delay.**

Note that, in all cases, the delay is inversely proportional to data rate, so for 128 kbps, the delay values would be half of those shown above. It can be seen that the concatenated Reed-Solomon cases increase the delay significantly (due mainly to interleaving/de-interleaving), while the TPC cases yield delays which are less than or equal to Sequential.

Table B-8. TPC/LDPC Summary

FOR	AGAINST
<ul style="list-style-type: none"> • Exceptionally good BER performance – significant improvement compared with every other FEC method in use today. • Most modes have no pronounced threshold effect – fails gracefully. • Exceptional bandwidth efficiency. • Coding gain independent of data rate (in this implementation). • Low decoding delay for TPC. • Easy field upgrade in CDM-625A. 	<p>Nothing!</p>

B.8 VersaFEC (Short-block LDPC)

VersaFEC is a system of short-block LDPC codes that have been designed as a low-latency alternative to both Comtech EF Data's existing LDPC codes, and to the system set forth in the DVB-S2 specification (EN 302307) ratified by ETSI.

Since the introduction of Comtech EF Data's LDPC, considerable research has been carried out to find ways to reduce the block size of LDPC (and hence its latency) while preserving the coding gain performance very close to the Shannon bound.

The set of VersaFEC codes was developed with two distinct purposes:

- 1) To provide an expanded choice of combinations of modulation and coding that maintain the same coding gain performance as Comtech EF Data's existing LDPC, while **significantly** reducing latency. The existing LDPC approach (and DVB-S2 short-block) uses blocks that are 16 kbits in length. VersaFEC, on the other hand, uses block sizes that vary between 2k and 8.2 kbits, and at the same time reduces latency still further through a novel design approach.
- 2) To provide combinations of modulation and coding (**ModCods**) that are suitable not only for Constant Coding and Modulation (**CCM**) applications, but are also the basis for a patent-pending Adaptive Coding and Modulation (**ACM**) system. The modulation types (BPSK, QPSK, 8-QAM and 16-QAM) and the code rates have been chosen to give a continuous progression of performance in terms of both Eb/No and spectral efficiency – an essential aspect of a well-engineered ACM system. There are 12 ModCods in the VersaFEC set. For a detailed discussion on ACM, see **Appendix M. VERSAFEC / VERSAFEC-2 ACM (ADAPTIVE CODING AND MODULATION) OPTION.**

Table B-9. The VersaFEC ModCod set

ModCod	Modulation	Code Rate	Spectral efficiency, bps/Hz	Block size, kbits	Typical Eb/No, for BER = 5×10^{-8} (dB)	Latency at 64 kbps (ms)	Min. Data Rate, CCM mode (kbps)	Max. Data Rate, CCM mode (Mbps)
00	BPSK	0.488	0.49	2	2.4	26	18	5.7
01	QPSK	0.533	1.07	4.1	2.2	53	20	10
02	QPSK	0.631	1.26	4.1	2.7	59	23	10
03	QPSK	0.706	1.41	4.1	3.4	62	26	10
04	QPSK	0.803	1.61	4.1	3.8	66	28	12
05	8-QAM	0.642	1.93	6.1	4.6	89	35	12
06	8-QAM	0.711	2.13	6.1	5.2	93	39	12
07	8-QAM	0.780	2.34	6.1	5.6	97	43	12
08	16-QAM	0.731	2.93	8.2	6.3	125	53	12
09	16-QAM	0.780	3.12	8.2	7.0	129	57	14
10	16-QAM	0.829	3.32	8.2	7.5	131	60	14
11	16-QAM	0.853	3.41	8.2	8.0	132	62	16

As a comparison, looking at LDPC Rate 2/3 8-QAM and VersaFEC Rate 0.642 8-QAM essentially identical spectral efficiency and Eb/No performance. However, at 64 kbps, the latency has been reduced from 350 milliseconds to 89 milliseconds – **reduction by a factor of 4**.

The performance of the VersaFEC codes compared with the Shannon bound is shown in **Figure B-2**. This puts the performance of VersaFEC at or near the DVB-S2 performance with 16 kbit blocks.

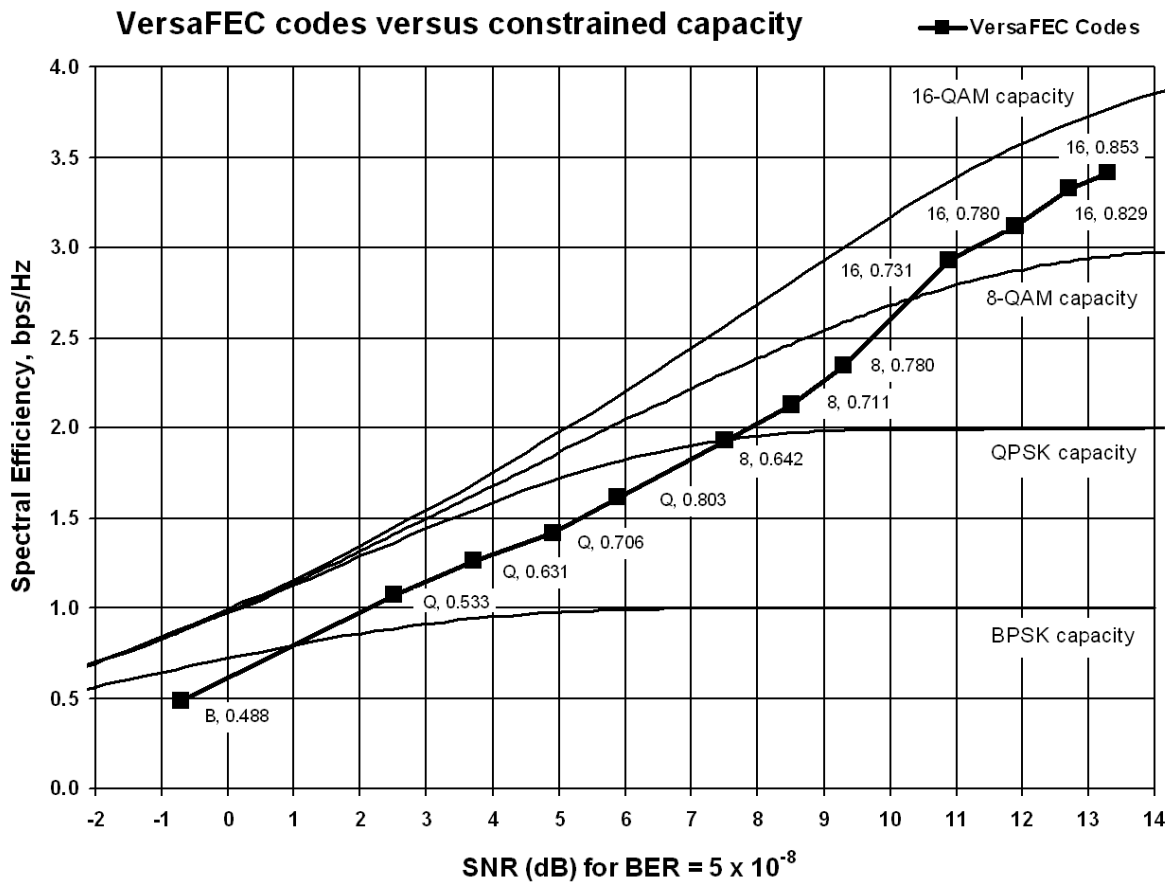

Figure B-2. VersaFEC Codes versus Shannon Capacity

Note that SNR is used in place of Eb/No – a convention for comparing ACM ModCods. SNR is defined as $E_b/N_0 + 10 \log(\text{Spectral Efficiency})$.



VersaFEC ACM requires the appropriate FAST code for the maximum operating symbol rate.

B.8.1 VersaFEC Extensions

B.8.1.1 Extended CCM Codes

Two additional rates are available with the VersaFEC family of codes. Note that these are CCM (Constant Coding and Modulation) only – they are NOT included in the ACM set of ModCods.

These two codes (Rate 0.576 8-QAM and Rate 0.644 16-QAM) have been added to fill in perceived gaps in the progression of spectral efficiency versus SNR. They do not, in fact, provide any discernible improvement in Eb/No performance (compared with their nearest neighbors in the initial VersaFEC family), but exhibit a modest SNR improvement.

Table B-10. Extended CCM Codes

Modulation	Code Rate	Spectral efficiency, bps/Hz	Typical Eb/No, for BER = 5×10^{-8}	Latency at 64 kbps, in milliseconds	Min. Data Rate, CCM mode	Max. Data Rate, CCM mode
8-QAM	0.576	1.73	4.5 dB	87	32 kbps	11 Mbps
16-QAM	0.644	2.58	6.5 dB	121	47 kbps	11 Mbps

B.8.1.2 Ultra-Low-Latency (ULL) Codes

Four additional ultra-short block LDPC codes address the needs of users with applications requiring even lower latency than the ‘standard’ VersaFEC code set. These codes (which are limited to BPSK and QPSK only) use significantly shorter code blocks than ‘standard’ VersaFEC, and as a result, the coding gain is slightly reduced. However, in terms of latency, the performance is exceptional – far lower than any other FEC method ever offered, with the exception of Viterbi.

Table B-11. ULL Codes

Modulation	Code Rate	Spectral efficiency, bps/Hz	Typical Eb/No, for BER = 5×10^{-8}	Latency at 64 kbps, in milliseconds	Min. Data Rate, CCM mode	Max. Data Rate, CCM mode
BPSK	0.493	0.49	3.3 dB	18	18 kbps	5.7 Mbps
QPSK	0.493	0.99	3.3 dB	19	18 kbps	6 Mbps
QPSK	0.654	1.30	3.8 dB	21	24 kbps	9 Mbps
QPSK	0.734	1.47	4.3 dB	23	27 kbps	9 Mbps

B.9 VersaFEC-2 ACM and CCM



Appendix M. VERSAFEC / VERSAFEC-2 ACM (ADAPTIVE CODING & MODULATION) OPTION

Comtech EF Data's second generation VersaFEC-2 comprises 74 new ModCods, with a new family of constellations. This new functionality requires the plug-in VersaFEC-2 Option Card, Firmware Version 1.3.1 or higher, and activation of the appropriate FAST codes.

- **VersaFEC-2** has two modes:
 - **Long Block** – Maximum coding gain with higher latency.
 - 38 ModCods – BPSK to 32-ARY modulation, 9600 symbol block size.
 - Spectral efficiency up to 4.4 bps/Hz for Long Block VersaFEC-2.
 - **Short Block** – Slightly lower coding gain with much lower latency.
 - 36 ModCods - BPSK to 32-ARY modulation, 1600 symbol block size.
 - Short Block performance is, overall, considerably better than 1st generation VersaFEC, with similar latency performance.
 - Short Block deliberately limits throughput to 2 Mbps in CCM (Constant Coding and Modulation) and 1 Msp in ACM (Adaptive Coding and Modulation). Above these limits, latency is no longer an issue, and Long Block is preferred.
 - Spectral efficiency up to 4.15 bps/Hz for Short Block VersaFEC-2.
- CCM and point-to-point ACM are supported in both modes.
- In CCM, links can be run with VersaFEC-2 in one direction, and any other supported FEC type in the other (Example: Rx = VersaFEC-2, Tx = TPC).
- In ACM, the range of rate bit rate adaptation is approximately 9:1.
- In ACM, both sides need to be VersaFEC-2, but Tx and Rx can be Short or Long – no restrictions (but NOT compatible in any way with 1st generation VersaFEC).
- If VersaFEC-2 is used on both sides of the link then, even in CCM operation, the remote modem's Eb/No can be seen on the front panel display/web pages, etc, of the local modem.
- VersaFEC-2 has increased throughput compared to VersaFEC – the full symbol rate of 12.5 Msp, and full bit rate of 25 Mbps in CCM and ACM (Long Block) are supported.
- VersaFEC-2 provides five modulation types – BPSK, QPSK, 8-ARY, 16-ARY, and 32-ARY.

- VersaFEC-2 adds new circular or quasi-circular constellations for higher-order modulations (above QPSK) to replace the square VersaFEC constellations.
- Es/No span from -1.3 dB (ModCod 0) to 16.3 dB (ModCod 37), giving an average of approx. 0.45 dB per ModCod, and a 17.6 dB total span.
- The overhead associated with AUPC is eliminated. (A framed mode such as EDMAC is normally required.)
- Combined AUPC and ACM operation is possible - VersaFEC-2 permits up to 10 dB of AUPC power increase, followed by 17.6 dB of ACM range, for a total of 27.6 dB of fade protection.

Table B-10. The VersaFEC-2 ModCod Set – Long Block

ModCod	Modulation	Code Rate	Spectral efficiency, bps/Hz	Block size, bits	Typical * Es/No (SNR), for BER = 1×10^{-8} (dB)	Latency at 128 kbps (ms)	Min. Data Rate, CCM Mode (kbps)	Max. Data Rate, CCM Mode (Mbps)	Min Sym Rate, ACM Mode (ksps)	Max Sym Rate, ACM Mode (Msps)
00	BPSK	0.489	0.489	4800	-1.3	79	18.0	6.1	37	12.5
01	QPSK	0.489	0.977	9600	1.5	153	18.0	12.2	37	12.5
02	QPSK	0.537	1.075	10560	2.0	170	19.3	13.4	37	12.5
03	QPSK	0.586	1.173	11520	2.6	185	21.1	14.7	37	12.5
04	QPSK	0.611	1.221	12000	2.8	193	22.0	15.3	37	12.5
05	QPSK	0.635	1.270	12480	3.2	200	22.9	15.9	37	12.5
06	QPSK	0.660	1.319	12960	3.5	208	23.7	16.5	37	12.5
07	QPSK	0.684	1.368	13440	3.7	215	24.6	17.1	37	12.5
08	QPSK	0.733	1.466	14400	4.4	231	26.4	18.3	37	12.5
09	8-ARY	0.521	1.564	15360	5.1	246	28.1	19.5	37	12.5
10	8-ARY	0.537	1.612	15840	5.4	254	29.0	20.2	37	12.5
11	8-ARY	0.562	1.686	16560	5.6	265	30.3	21.1	37	12.5
12	8-ARY	0.586	1.759	17280	5.8	276	31.7	22.0	37	12.5
13	8-ARY	0.611	1.832	18000	6.0	287	33.0	22.9	37	12.5
14	8-ARY	0.635	1.906	18720	6.2	299	34.3	23.8	37	12.5
15	8-ARY	0.660	1.979	19440	6.5	311	35.6	24.7	37	12.5
16	8-ARY	0.684	2.052	20160	6.9	322	36.9	25.0	37	12.2
17	8-ARY	0.708	2.125	20880	7.2	333	38.3	25.0	37	11.8
18	8-ARY	0.733	2.199	21600	7.5	345	39.6	25.0	37	11.4
19	16-ARY	0.586	2.345	23040	8.1	368	42.2	25.0	37	10.7
20	16-ARY	0.611	2.443	24000	8.6	383	44.0	25.0	37	10.2
21	16-ARY	0.635	2.541	24960	8.9	398	45.7	25.0	37	9.8
22	16-ARY	0.660	2.638	25920	9.2	413	47.5	25.0	37	9.5
23	16-ARY	0.684	2.736	26880	9.6	429	49.3	25.0	37	9.1
24	16-ARY	0.708	2.834	27840	10.0	444	51.0	25.0	37	8.8
25	16-ARY	0.733	2.932	28800	10.5	459	52.8	25.0	37	8.5
26	16-ARY	0.757	3.029	29760	10.9	474	54.5	25.0	37	8.3
27	16-ARY	0.782	3.127	30720	11.4	489	56.3	25.0	37	8.0
28	32-ARY	0.660	3.298	32400	12.0	517	59.4	25.0	37	7.6
29	32-ARY	0.684	3.420	33600	12.5	535	61.6	25.0	37	7.3
30	32-ARY	0.708	3.542	34800	12.9	554	63.8	25.0	37	7.1
31	32-ARY	0.733	3.664	36000	13.3	573	66.0	25.0	37	6.8
32	32-ARY	0.757	3.787	37200	13.7	592	68.2	25.0	37	6.6
33	32-ARY	0.782	3.909	38400	14.2	610	70.4	25.0	37	6.4
34	32-ARY	0.801	4.007	39360	14.7	625	72.1	25.0	37	6.2
35	32-ARY	0.831	4.153	40800	15.2	648	74.8	25.0	37	6.0
36	32-ARY	0.855	4.275	42000	16.0	667	77.0	25.0	37	5.8
37	32-ARY	0.879	4.397	43200	16.7	685	79.2	25.0	37	5.7

Table B-11. The VersaFEC-2 ModCod Set – Short Block

ModCod	Modulation	Code Rate	Spectral efficiency, bps/Hz	Block size, bits	Typical * Es/No (SNR), for BER = 1×10^{-8} (dB)	Latency at 128 kbps (ms)	Min. Data Rate, CCM Mode (kbps)	Max. Data Rate, CCM Mode (Mbps)	Min Sym Rate, ACM Mode (ksps)	Max Sym Rate, ACM Mode (Msps)
00	BPSK	0.489	0.489	800	-0.2	16	18.0	2.0	37	1
01	QPSK	0.489	0.977	1600	2.3	30	18.0	2.0	37	1
02	QPSK	0.537	1.075	1760	2.8	33	19.3	2.0	37	1
03	QPSK	0.586	1.173	1920	3.4	36	21.1	2.0	37	1
04	QPSK	0.611	1.221	2000	3.7	37	22.0	2.0	37	1
05	QPSK	0.635	1.270	2080	3.9	38	22.9	2.0	37	1
06	QPSK	0.660	1.319	2160	4.2	39	23.7	2.0	37	1
07	QPSK	0.684	1.368	2240	4.5	41	24.6	2.0	37	1
08	QPSK	0.733	1.466	2400	5.2	43	26.4	2.0	37	1
09	8-ARY	0.521	1.564	2560	5.6	46	28.1	2.0	37	1
10	8-ARY	0.537	1.612	2640	5.9	47	29.0	2.0	37	1
11	8-ARY	0.562	1.686	2760	6.2	49	30.3	2.0	37	1
12	8-ARY	0.586	1.759	2880	6.4	51	31.7	2.0	37	1
13	8-ARY	0.611	1.832	3000	6.6	53	33.0	2.0	37	1
14	8-ARY	0.635	1.906	3120	6.9	55	34.3	2.0	37	1
15	8-ARY	0.660	1.979	3240	7.2	57	35.6	2.0	37	1
16	8-ARY	0.684	2.052	3360	7.5	59	36.9	2.0	37	1
17	8-ARY	0.708	2.125	3480	7.8	61	38.3	2.0	37	1
18	8-ARY	0.733	2.199	3600	8.3	63	39.6	2.0	37	1
19	16-ARY	0.586	2.345	3840	8.7	67	42.2	2.0	37	1
20	16-ARY	0.611	2.443	4000	9.0	70	44.0	2.0	37	1
21	16-ARY	0.635	2.541	4160	9.3	73	45.7	2.0	37	1
22	16-ARY	0.660	2.638	4320	9.7	76	47.5	2.0	37	1
23	16-ARY	0.684	2.736	4480	10.3	79	49.3	2.0	37	1
24	16-ARY	0.708	2.834	4640	10.7	82	51.0	2.0	37	1
25	16-ARY	0.733	2.932	4800	11.0	85	52.8	2.0	37	1
26	16-ARY	0.757	3.029	4960	11.6	88	54.5	2.0	37	1
27	16-ARY	0.782	3.127	5120	12.2	91	56.3	2.0	37	1
28	32-ARY	0.660	3.298	5400	12.8	93	59.4	2.0	37	1
29	32-ARY	0.684	3.420	5600	13.1	96	61.6	2.0	37	1
30	32-ARY	0.708	3.542	5800	13.4	99	63.8	2.0	37	1
31	32-ARY	0.733	3.664	6000	14.0	102	66.0	2.0	37	1
32	32-ARY	0.757	3.787	6200	14.4	105	68.2	2.0	37	1
33	32-ARY	0.782	3.909	6400	14.8	109	70.4	2.0	37	1
34	32-ARY	0.801	4.007	6560	15.2	112	72.1	2.0	37	1
35	32-ARY	0.831	4.153	6800	15.8	117	74.8	2.0	37	1

Notes:

- 1) * Typical Es/No values are shown – guaranteed values are 0.3 dB higher.
- 2) Note that Es/No (SNR) is used in place of Eb/No, a convention for comparing ACM ModCods. SNR is defined as:

$$Es/No = Eb/No + 10 * 10_{\log}(\text{Spectral Efficiency})$$

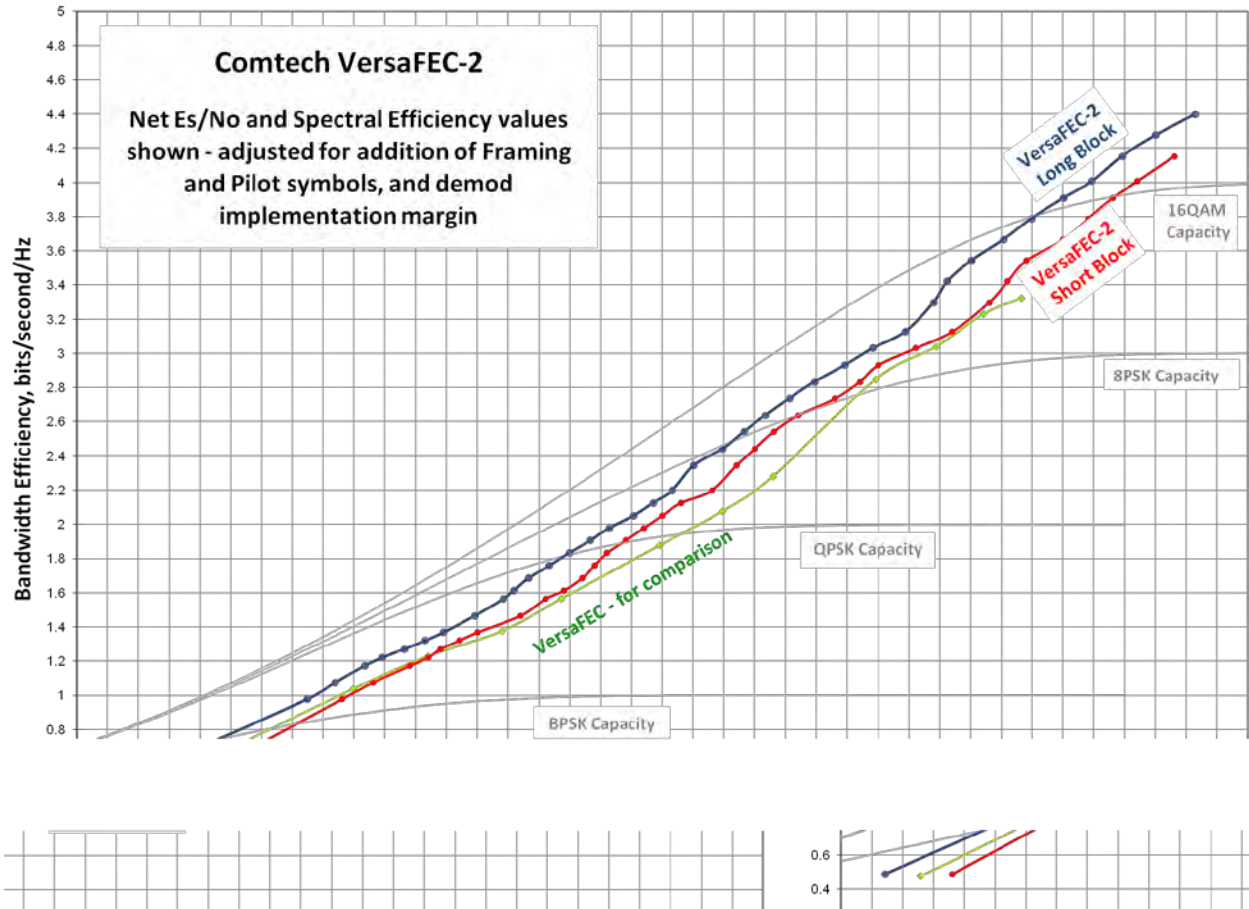

Figure B-3. VersaFEC-2 Codes vs. Constrained Capacity (Typical Values Shown)

B.9.1 VersaFEC-2 ACM Latency

Section M.6.1 addresses latency in VersaFEC ACM mode. Table B-12 summarizes both VersaFEC-2 Long and Short Block modes:

Table B-12. VersaFEC-2 End-to-End Latency @ 100 ksps

VersaFEC-2 Mode	Min Throughput @ 100 ksps	Max Throughput @ 100 ksps	End-to-end Latency
VersaFEC-2 Short Block	48.9 kbps	415.3 kbps	40.4 ms
VersaFEC-2 Long Block	48.9 kbps	439.7 kbps	205 ms

As explained in Section M.6.1, these figures do not include the WAN buffer latency (where used).

B.10 Uncoded Operation (No FEC)



CAUTION – Comtech EF Data strongly cautions users when using uncoded operation. If the acquisition sweep width exceeds one quarter of the symbol rate, there is a very high probability that the demodulator will false lock.

Example: If selecting 64 kbps QPSK, uncoded, the symbol rate will be half of this rate, or 32 ksymbols/second. One quarter of this equals 8 kHz. Therefore, the absolute maximum acquisition sweep range that should be considered is ± 8 kHz. If there is any frequency uncertainty on the incoming carrier, this should be subtracted from the sweep width. The problem becomes progressively better with increasing symbol rate.

Comtech EF Data cannot be held responsible for incorrect operation if you do not adhere to these guidelines when using uncoded operation.

There are occasions where a user may wish to operate a satellite link with no forward error correction of any kind. For this reason, the CDM-625A offers this uncoded mode for three modulation types – BPSK, QPSK, and OQPSK. However, you should be aware of some of the implications of using this approach.

PSK demodulators have two inherent undesirable features. The first, known as ‘phase ambiguity’, is due to the fact the demodulator does not have any absolute phase reference and, in the process of carrier recovery, the demodulator can lock up in any of K phase states where K = 2 for BPSK, K = 4 for QPSK. Without the ability to resolve these ambiguous states, there would be a 1-in-2 chance that the data at the output of the demodulator would be wrong in the case of BPSK. For QPSK, the probability would be 3-in-4.

The problem is solved in the case of BPSK by differentially encoding the data prior to transmission, then performing the inverse decoding process. This is a very simple process, but has the disadvantage that it doubles the receive BER. For every bit error the demodulator produces, the differential decoder produces two.

The problem for QPSK is more complex, as there are four possible lock states leading to four ambiguities. When FEC is employed, the lock state of the FEC decoder can be used to resolve two of the four ambiguities, and the remaining two can be resolved using serial differential encoding/decoding. However, when no FEC is being used, an entirely different scheme must be used. Therefore, in QPSK, a parallel differential encoding/decoding technique is used, but has the disadvantage that it again doubles the receive BER.

OQPSK is a different situation again, where the ambiguities result not only from not having an absolute phase reference, but also not knowing which of the two parallel paths in the demod, I or Q, contains the half-symbol delay. Another type of differential encoding is used, but yet again the error rate is doubled, compared to ideal.



Whenever uncoded operation is selected, the modem offers the choice between enabling and disabling the differential encoder/decoder appropriate for the modulation type.

The second problem inherent in PSK demodulators is that of 'data false locking'. In order to accomplish the task of carrier recovery, the demodulator must use a non-linear process. BPSK uses a second-order non-linearity; QPSK uses a fourth-order non-linearity. When you use data at a certain symbol rate to modulate the carrier, the demodulator can lock at incorrect frequencies, spaced at intervals of one-quarter of the symbol rate away from the carrier. Fortunately, when you use FEC decoding, the decoder synchronization state can be used to verify the correct lock point has been achieved, and to reject the false locks.

However, if you use uncoded operation, there is no way to recognize a data false lock. The demodulator will indicate that it is correctly locked, but the data out will not be correct.

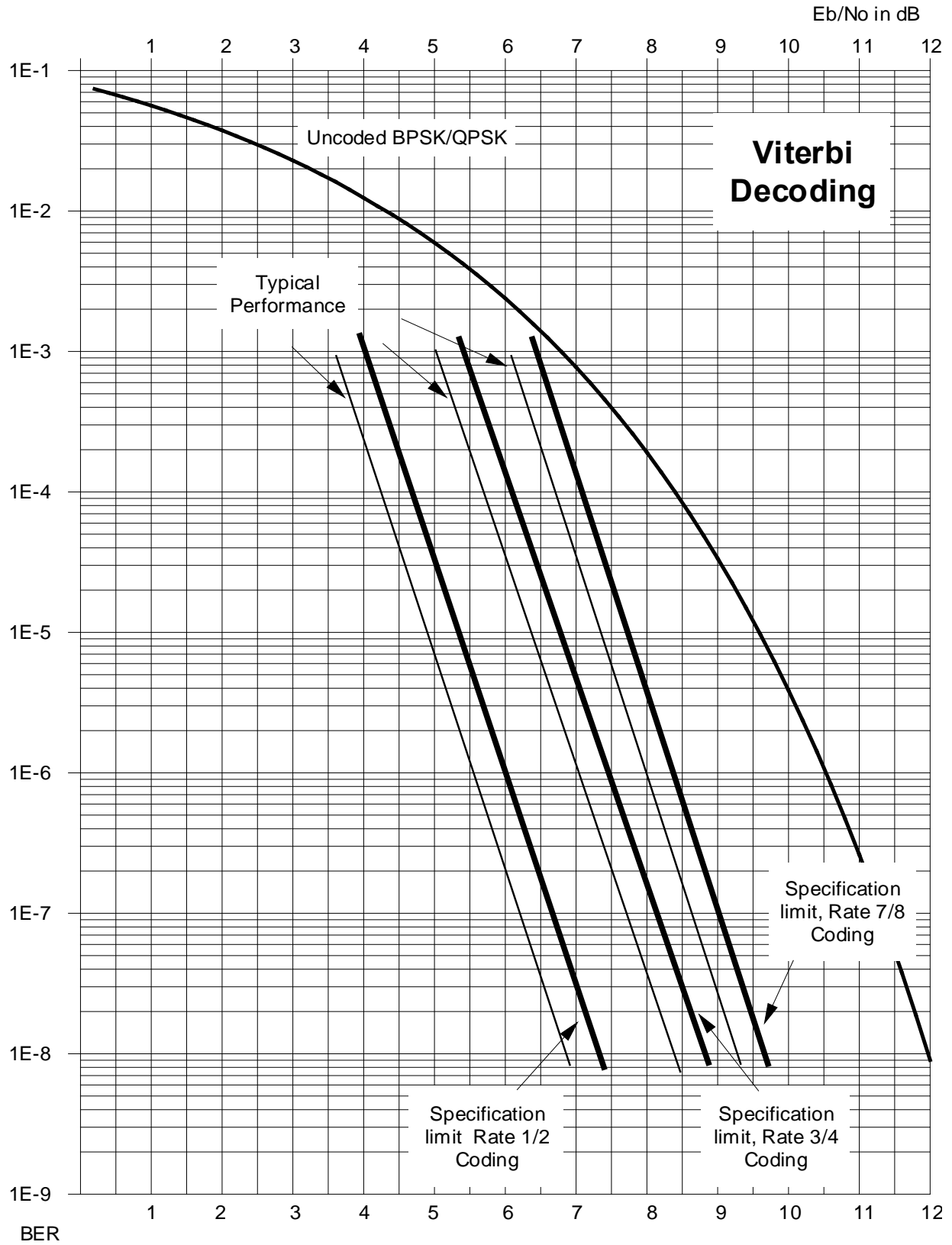

Figure B-4. Viterbi Decoding

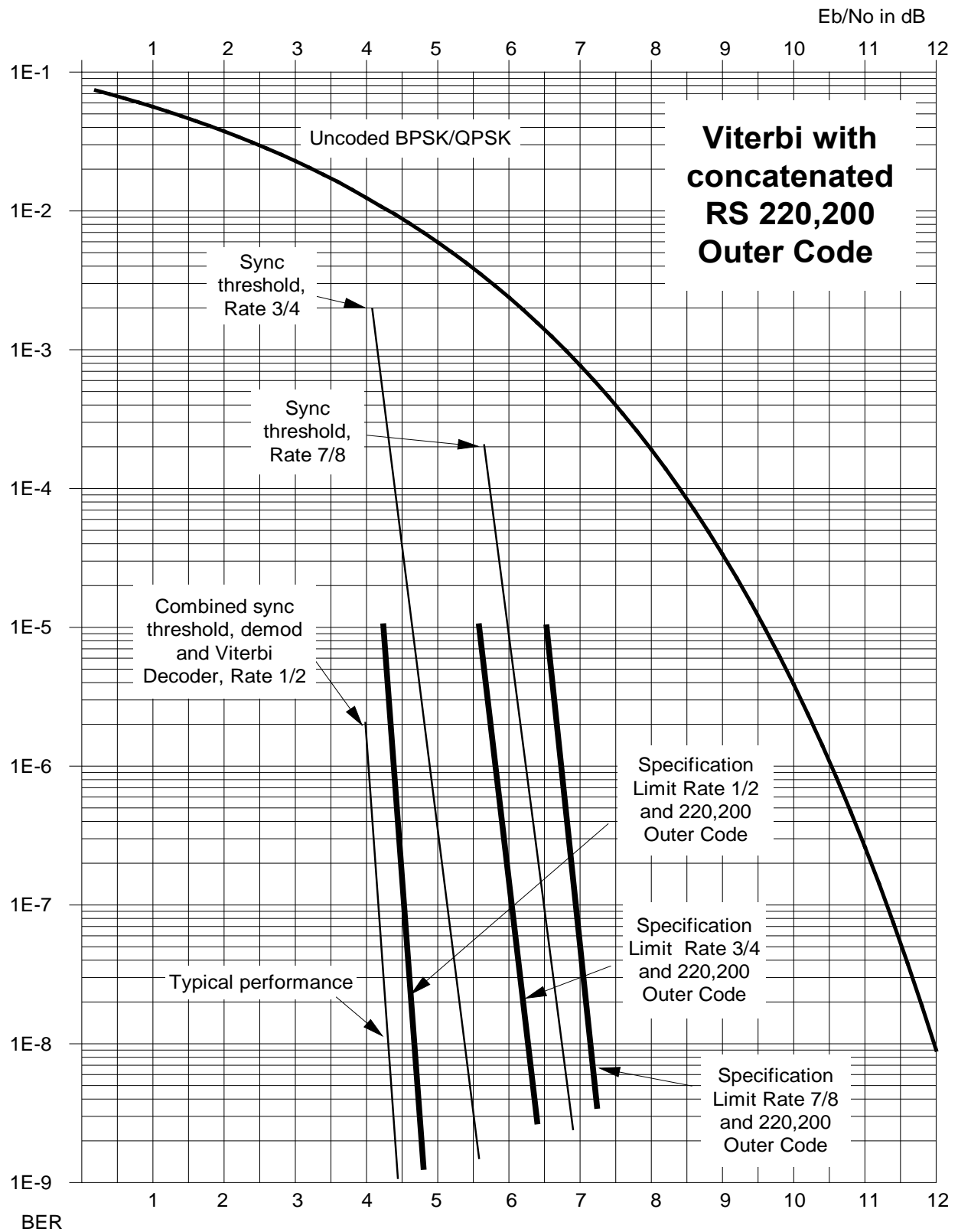

Figure B-5. Viterbi with Concatenated RS 220, 200 Outer Code

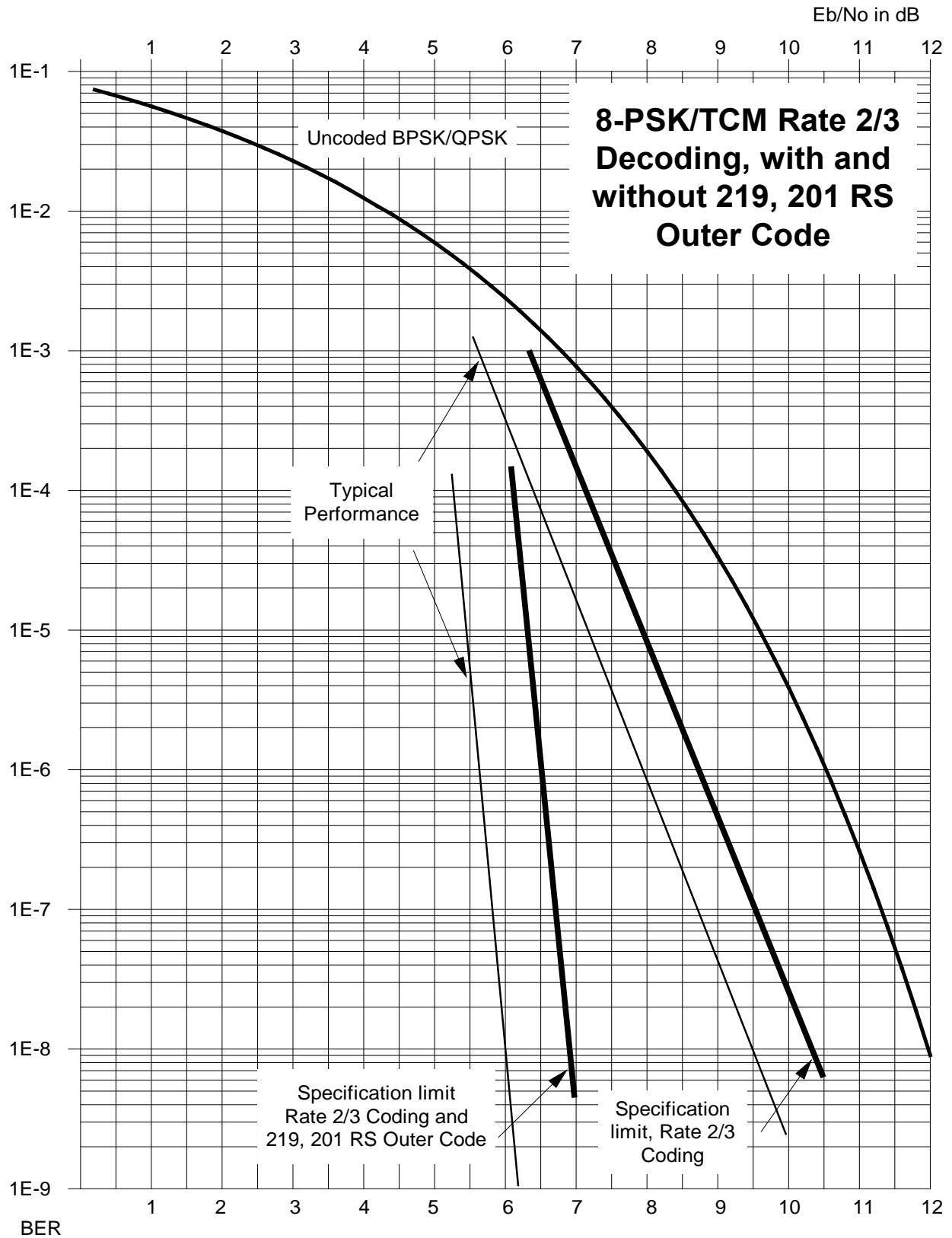

Figure B-6. 8-PSK/TCM Rate 2/3 Decoding with/without Concatenated RS 219, 201 Outer Code

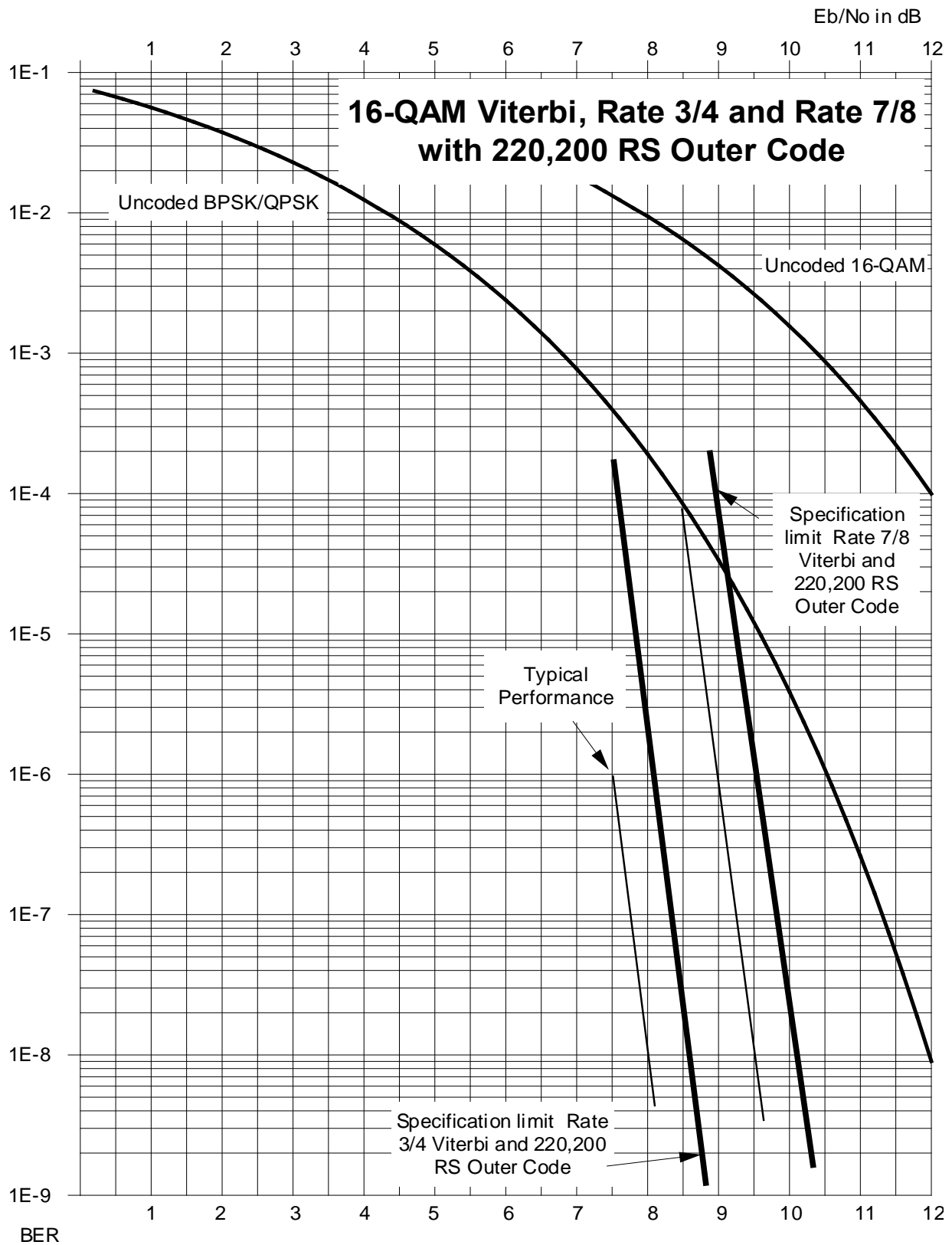

Figure B-7. 16-QAM Rates 3/4 and 7/8 with Concatenated RS 220,200 Outer Code

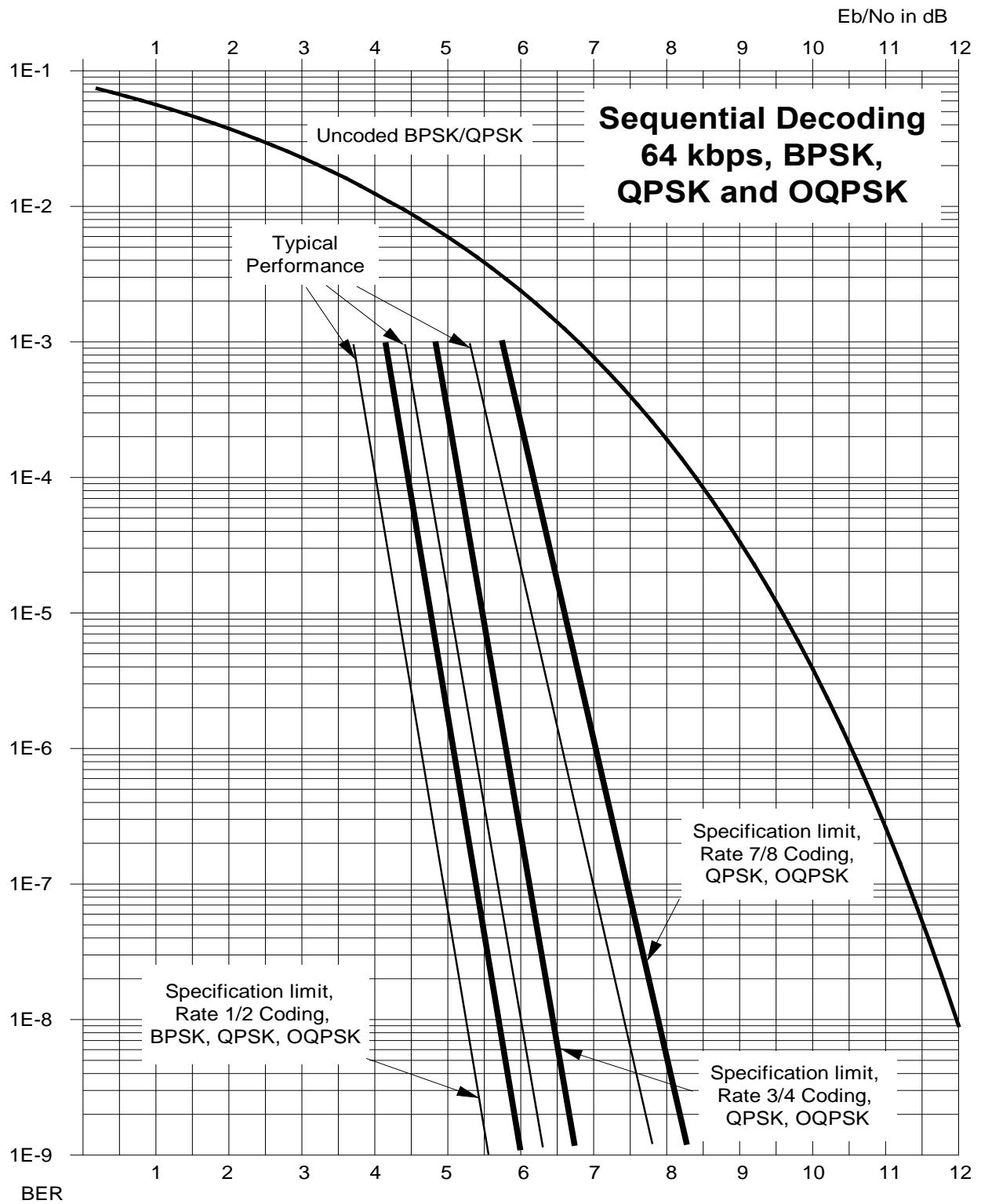

Figure B-8. Sequential Decoding at 64 kbps, BPSK, QPSK, and OQPSK

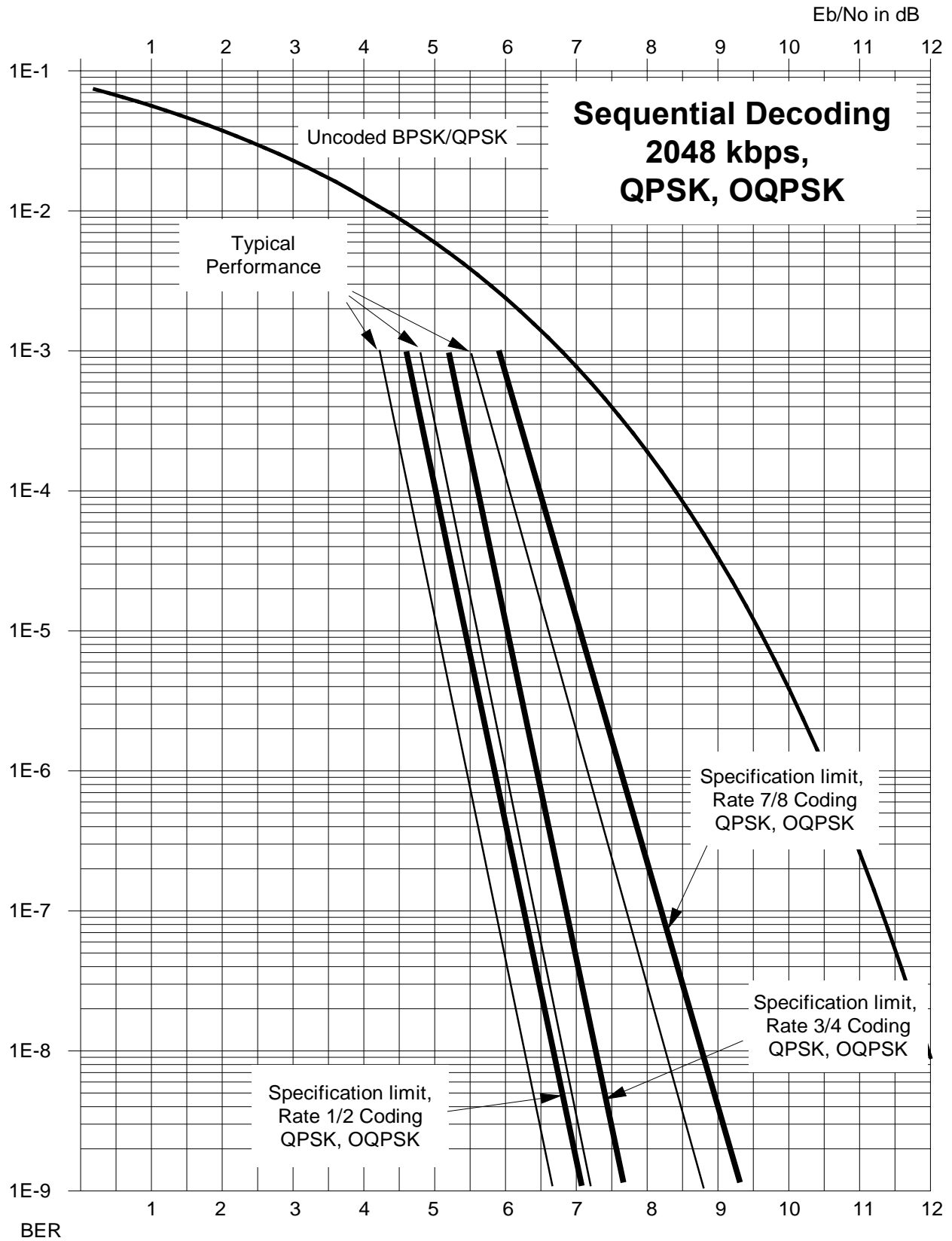

Figure B-9. Sequential Decoding at 2048 kbps QPSK, OQPSK

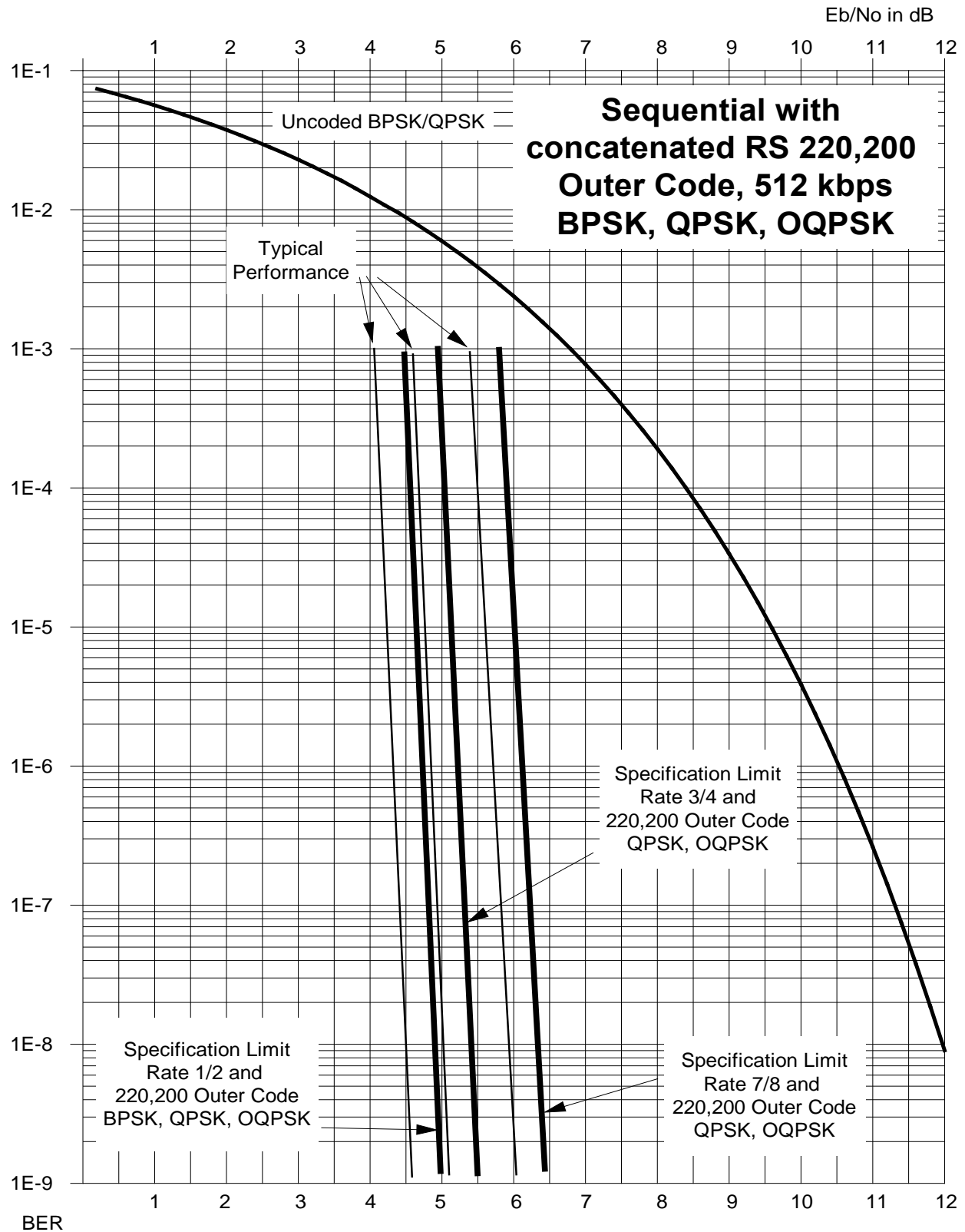

Figure B-10. Sequential Decoding at 512 kbps with Concatenated RS 220,200 Outer Code BPSK, QPSK, OQPSK

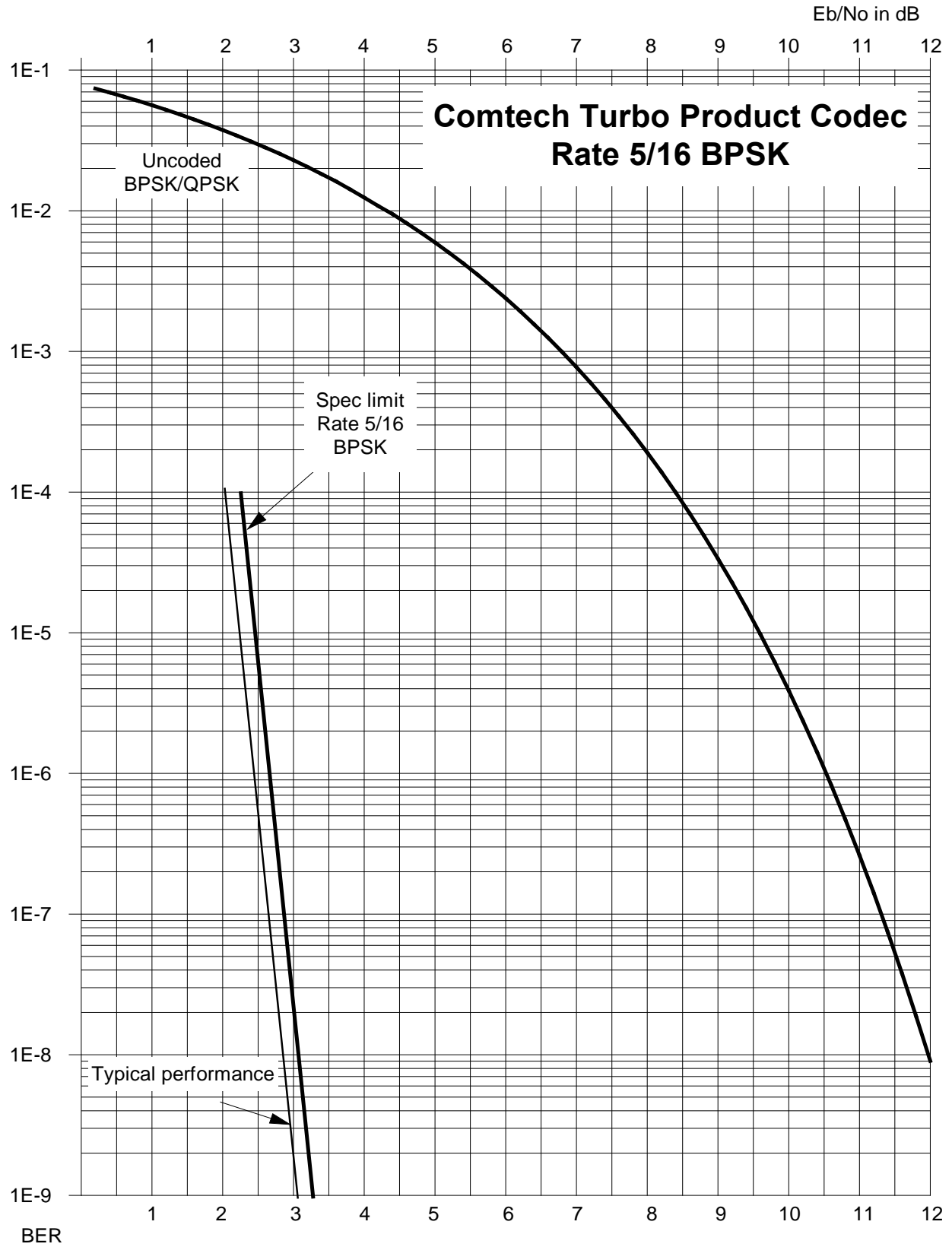

Figure B-11. Turbo Product Code Rate 5/16 BPSK

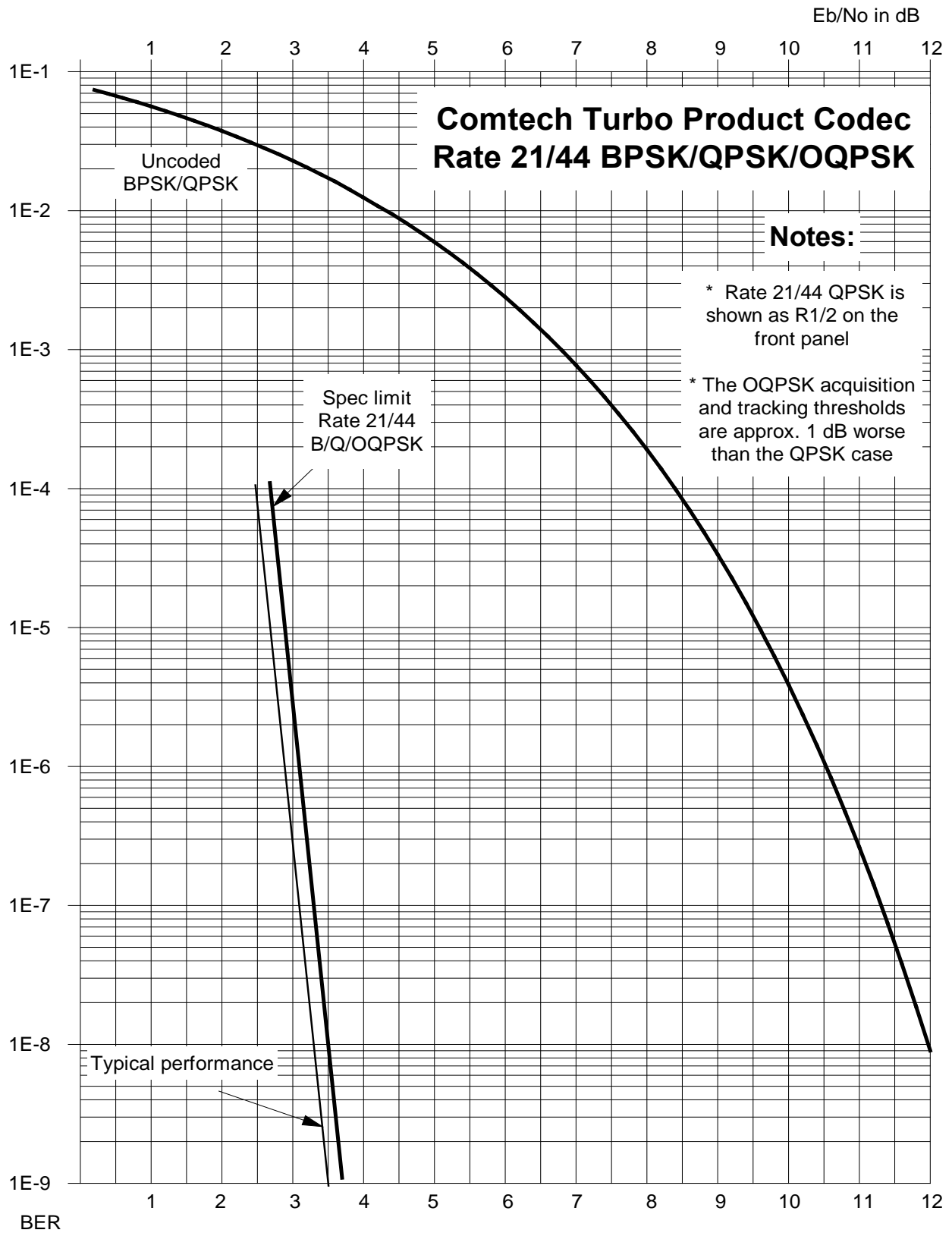

Figure B-12. Turbo Product Codec Rate 21/44 BPSK/QPSK/OQPSK

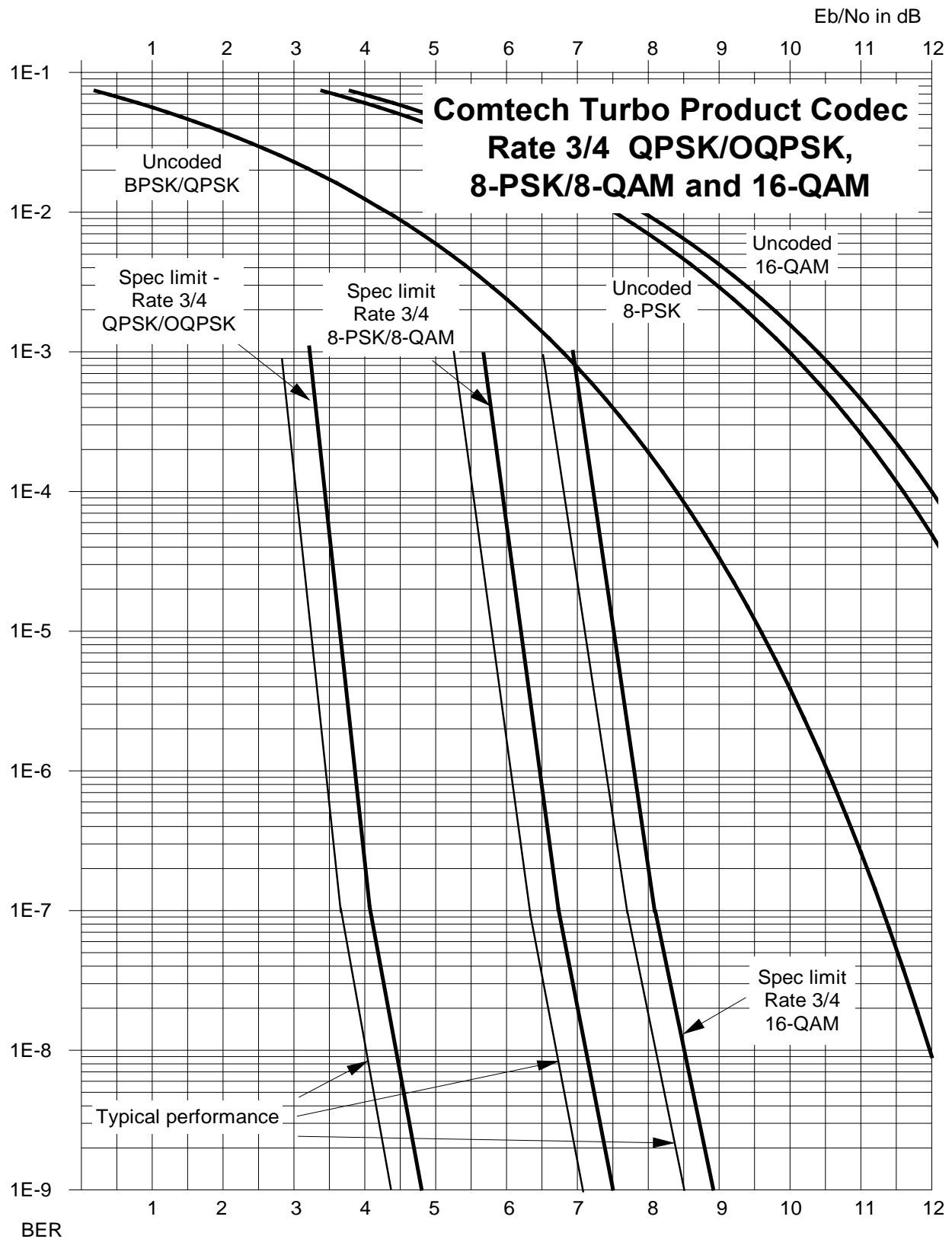

Figure B-13. Turbo Product Codec Rate 3/4 QPSK/OQPSK, 8-PSK/8-QAM, and 16-QAM

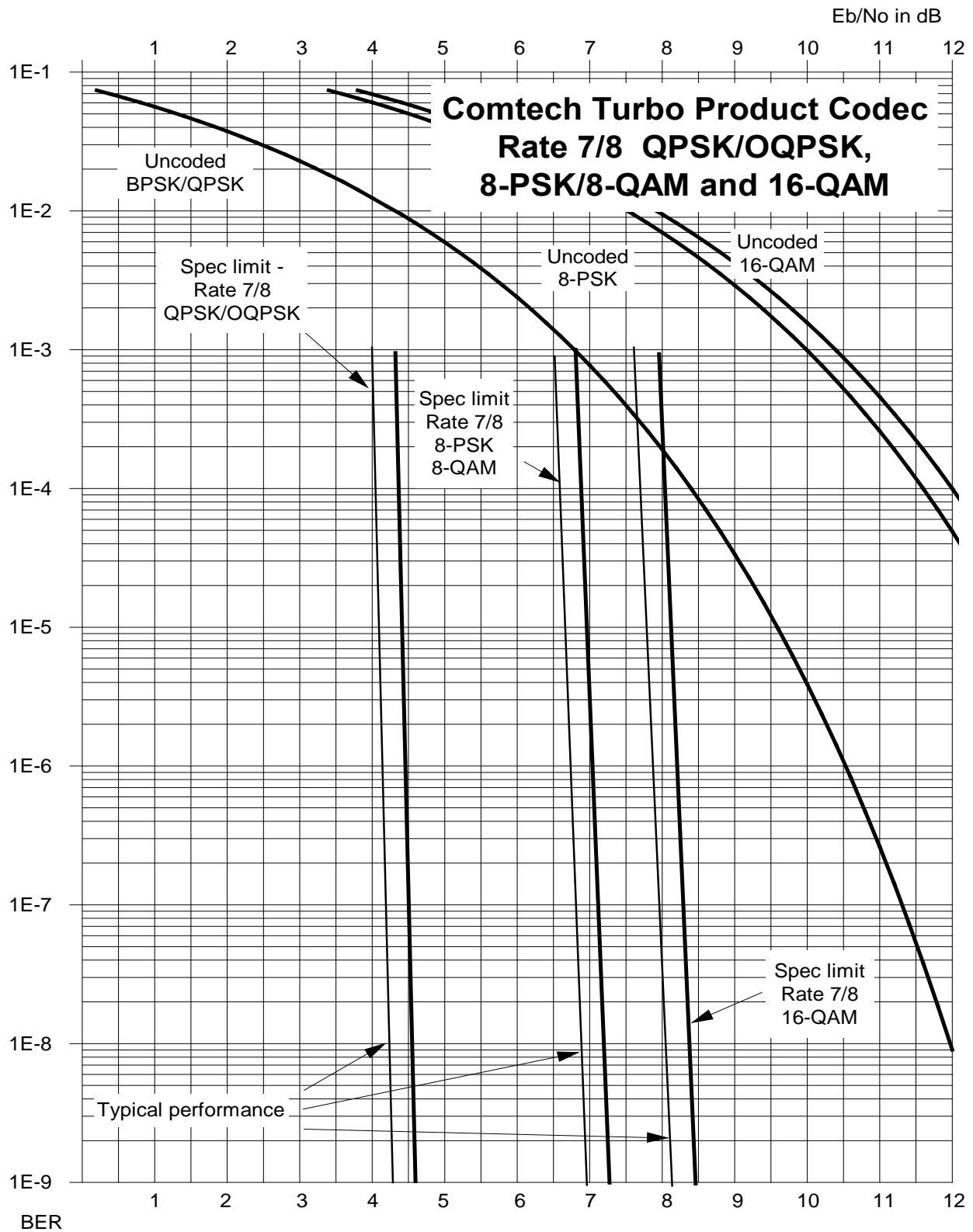

Figure B-14. Turbo Product Codec Rate 7/8 QPSK/OQPSK, 8-PSK/8-QAM, and 16-QAM

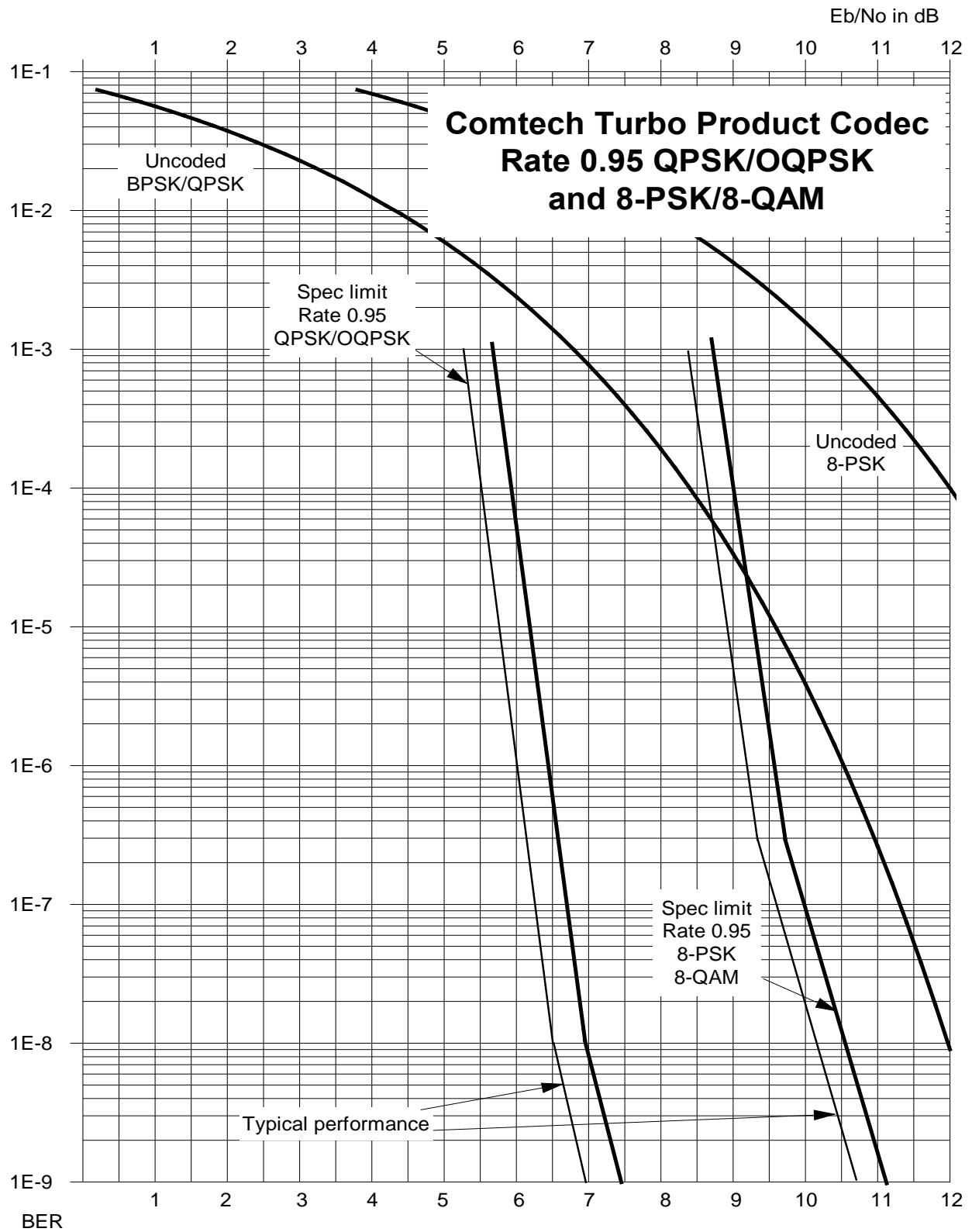

Figure B-15. Turbo Product Codec Rate 0.95 QPSK/OQPSK and 8-PSK/Q-QAM

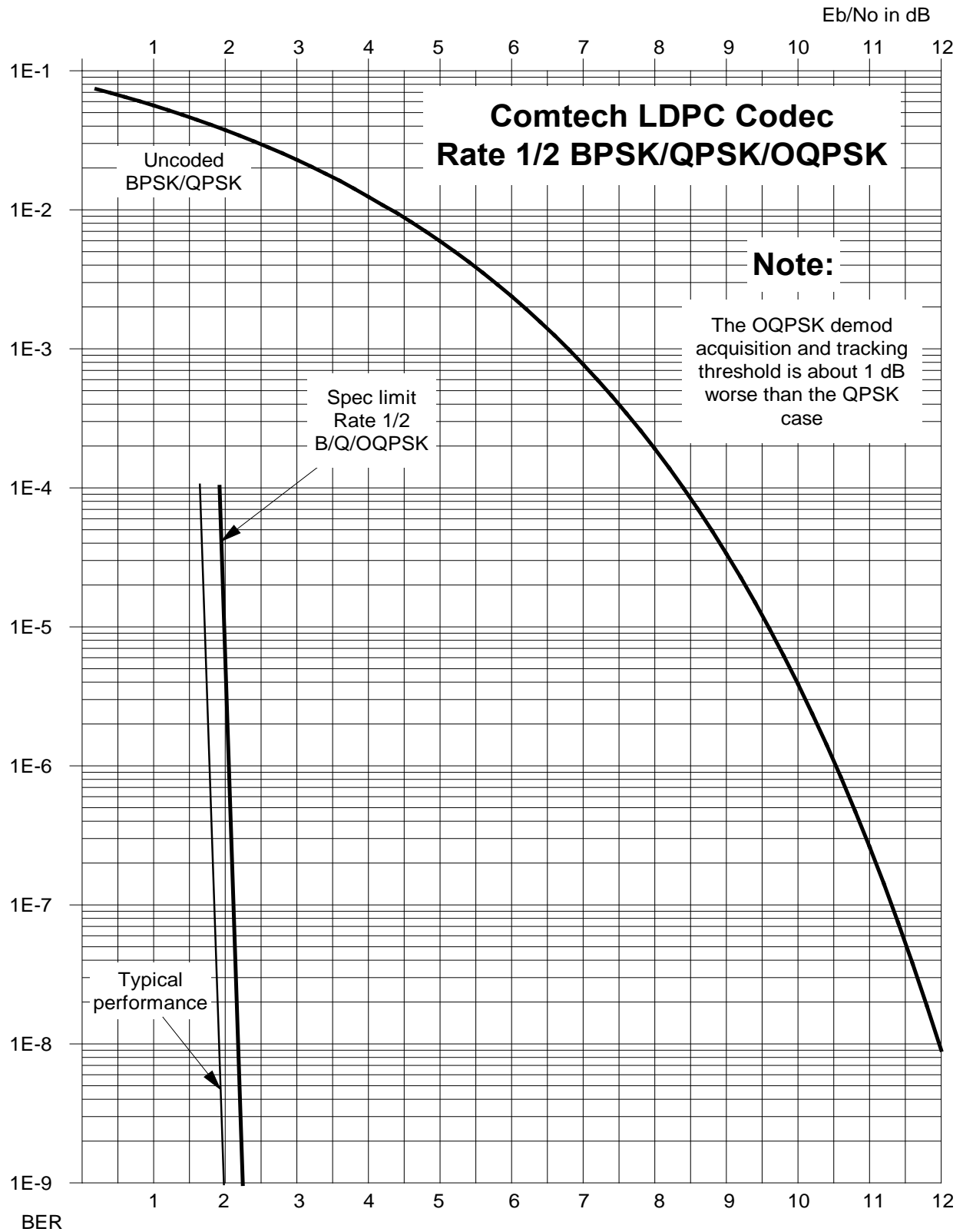

Figure B-16. LDPC Codec Rate 1/2 BPSK/QPSK/OQPSK

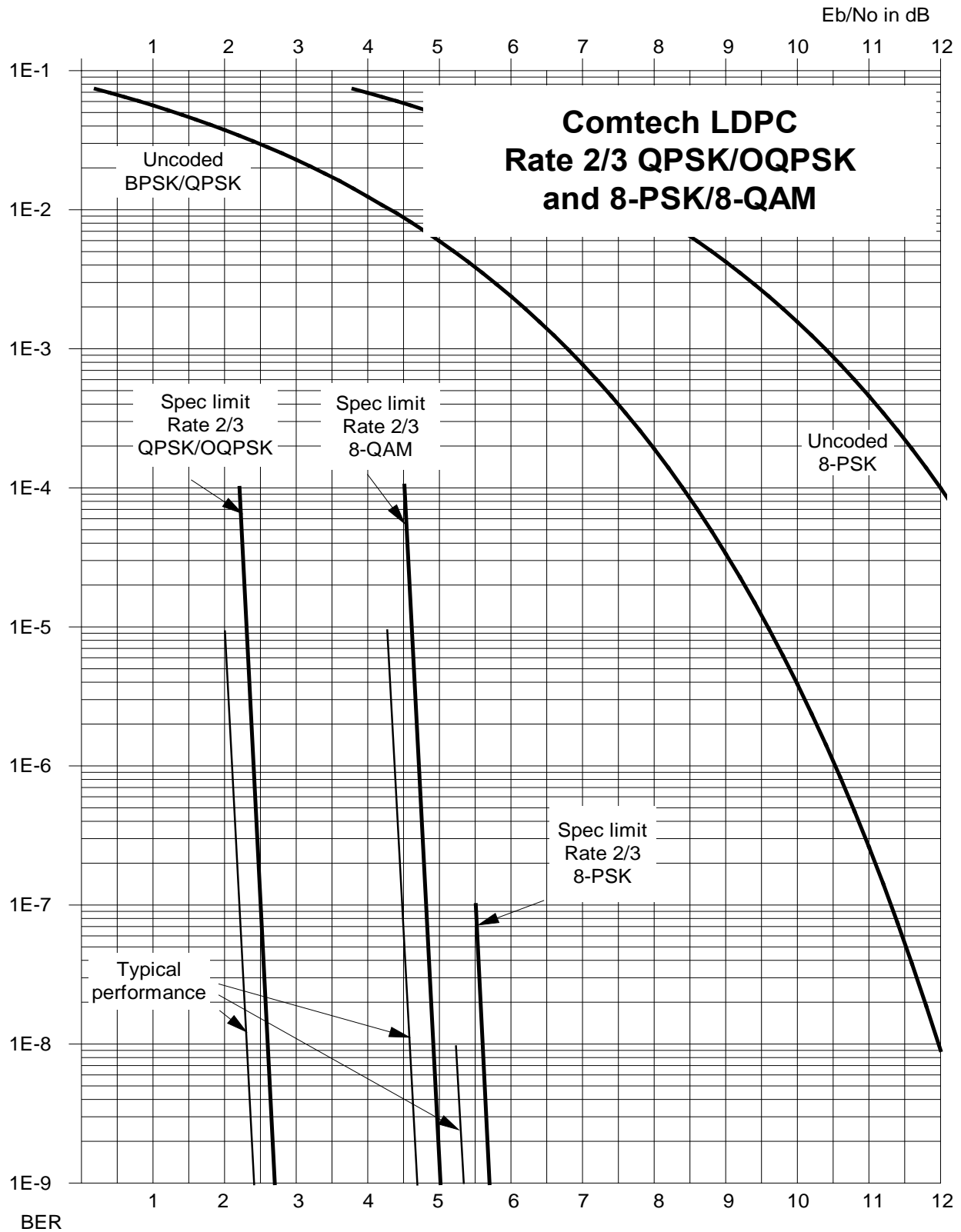

Figure B-17. LDPC Codec Rate 2/3 QPSK/OQPSK and 8-PSK/8-QAM

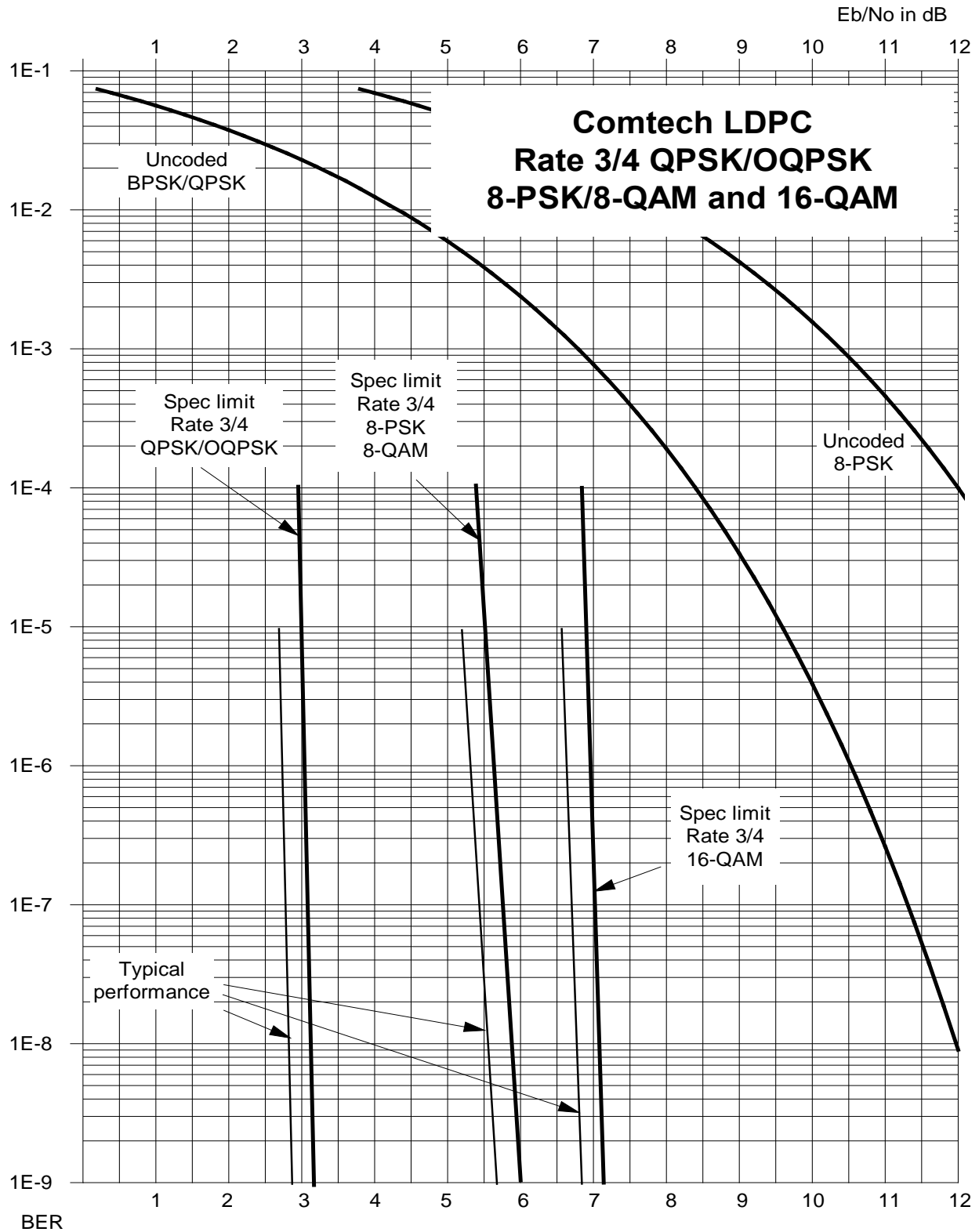

Figure B-18. LDPC Codec Rate 3/4 QPSK/OQPSK, 8-PSK/8-QAM, and 16-QAM

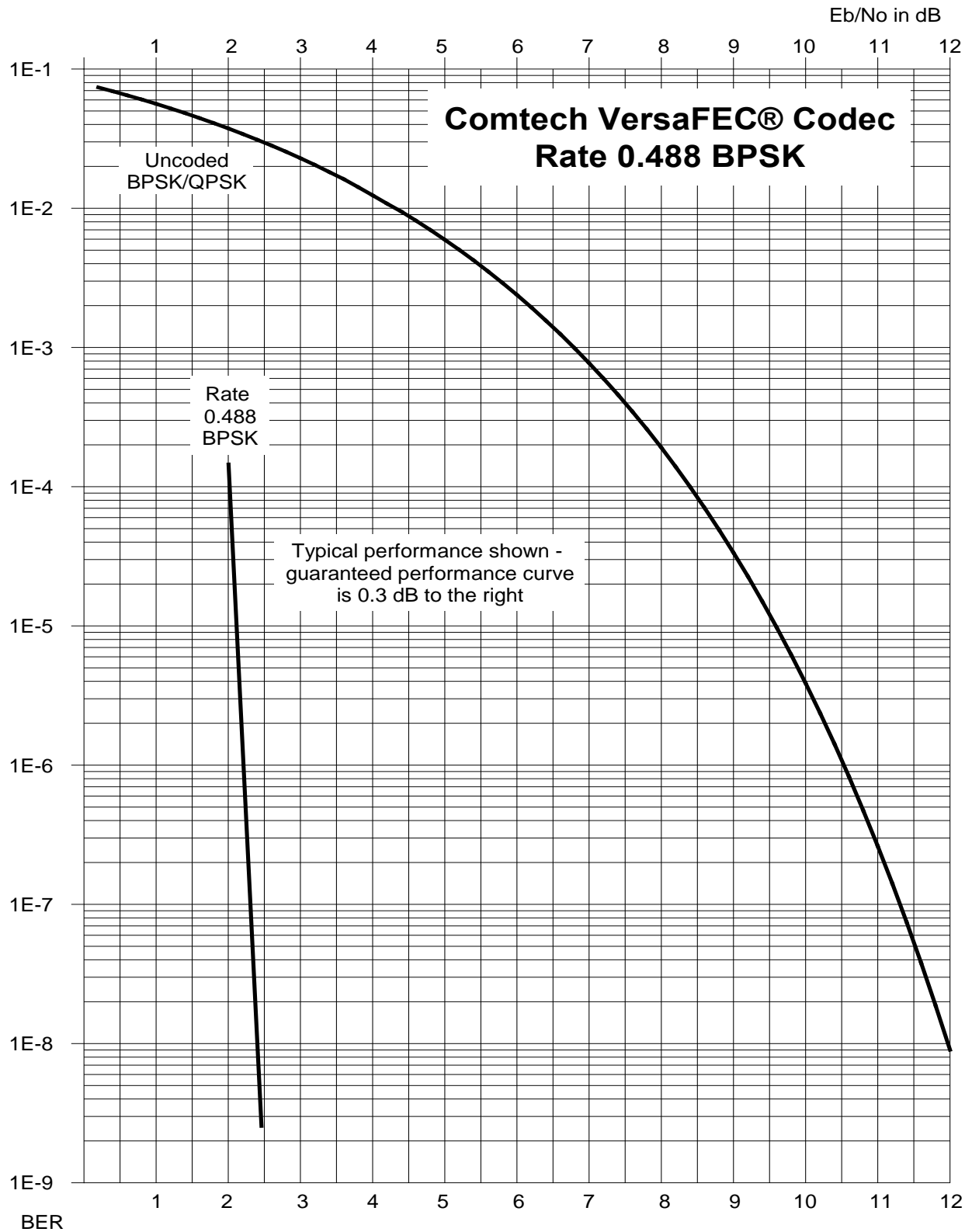

Figure B-19. VersaFEC Codec Rate 0.488 BPSK

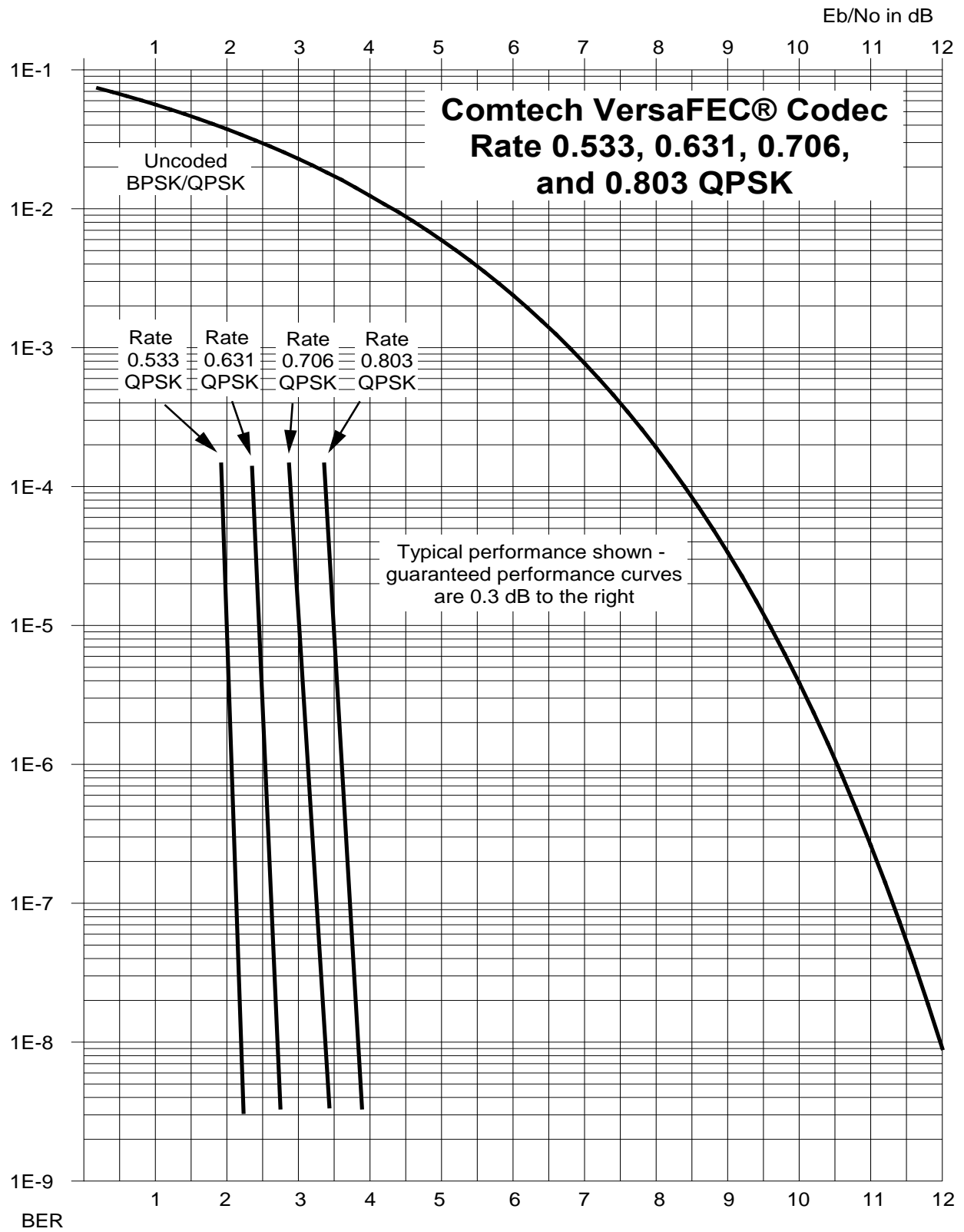

Figure B-20. VersaFEC Codec Rates 0.533, 0.631, 0.706, and 0.803 QPSK

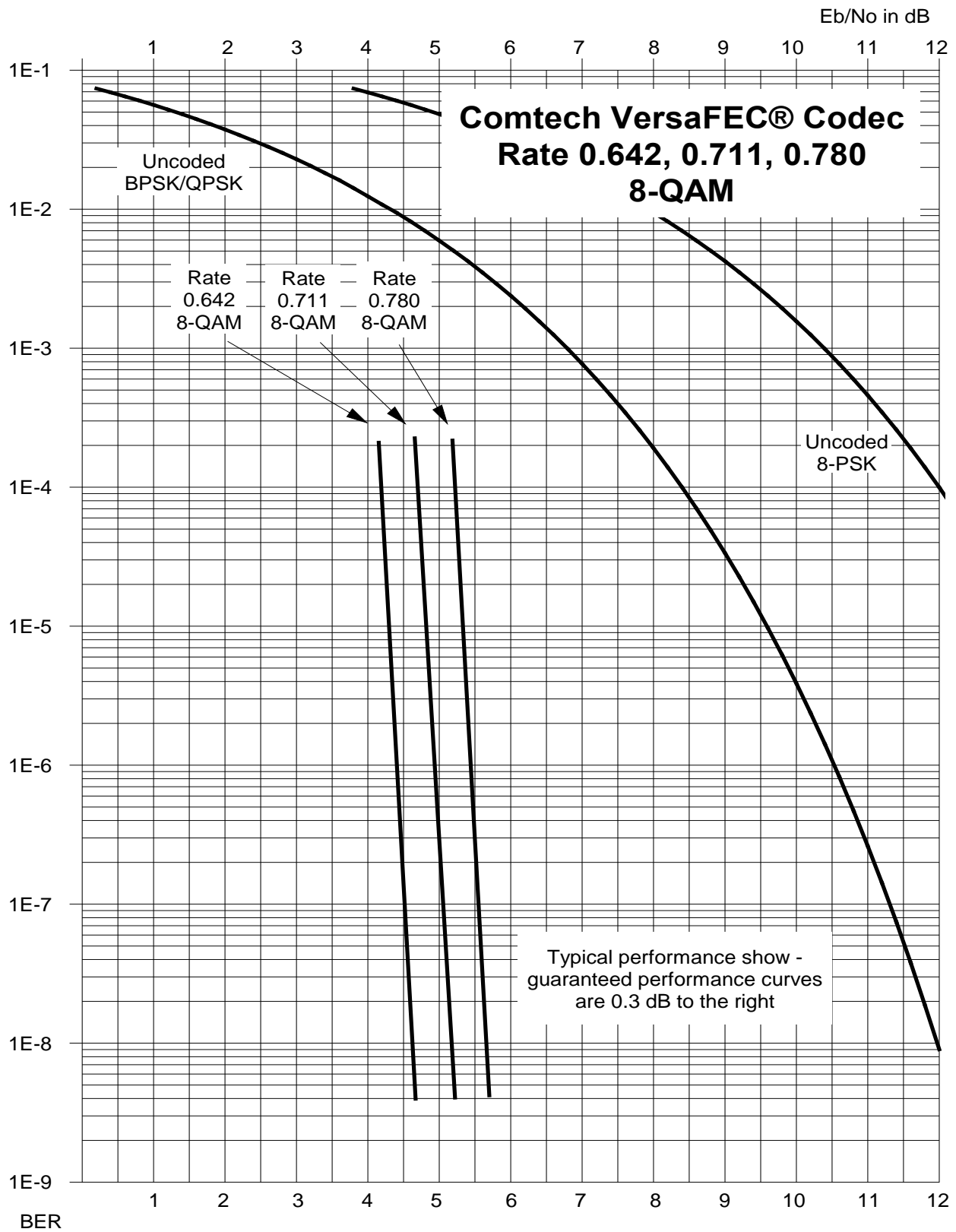

Figure B-21. VersaFEC Codec Rates 0.642, 0.711, and 0.780 8-QAM

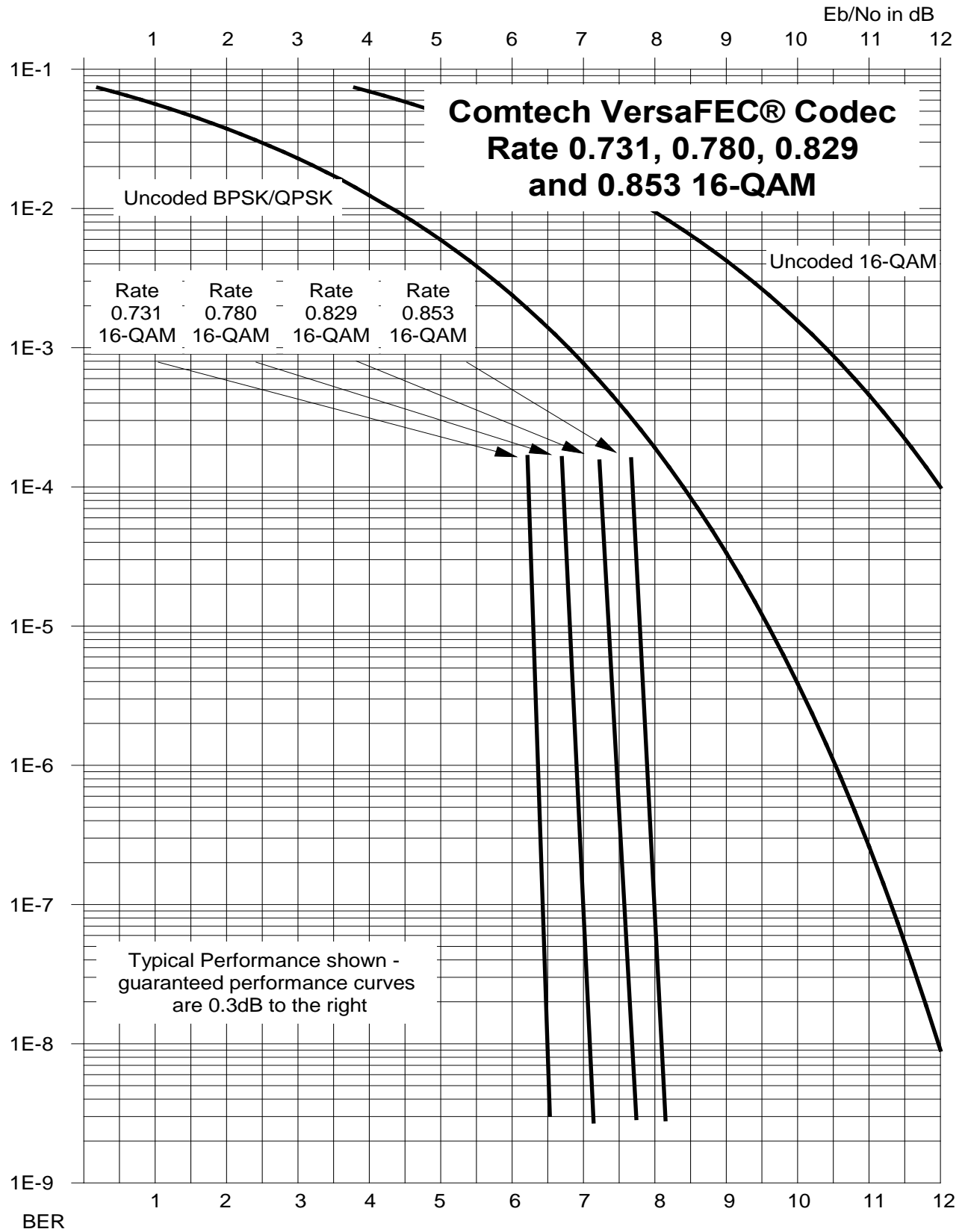

Figure B-22. VersaFEC Codec Rates 0.731, 0.780, 0.829, and 0.853 16-QAM

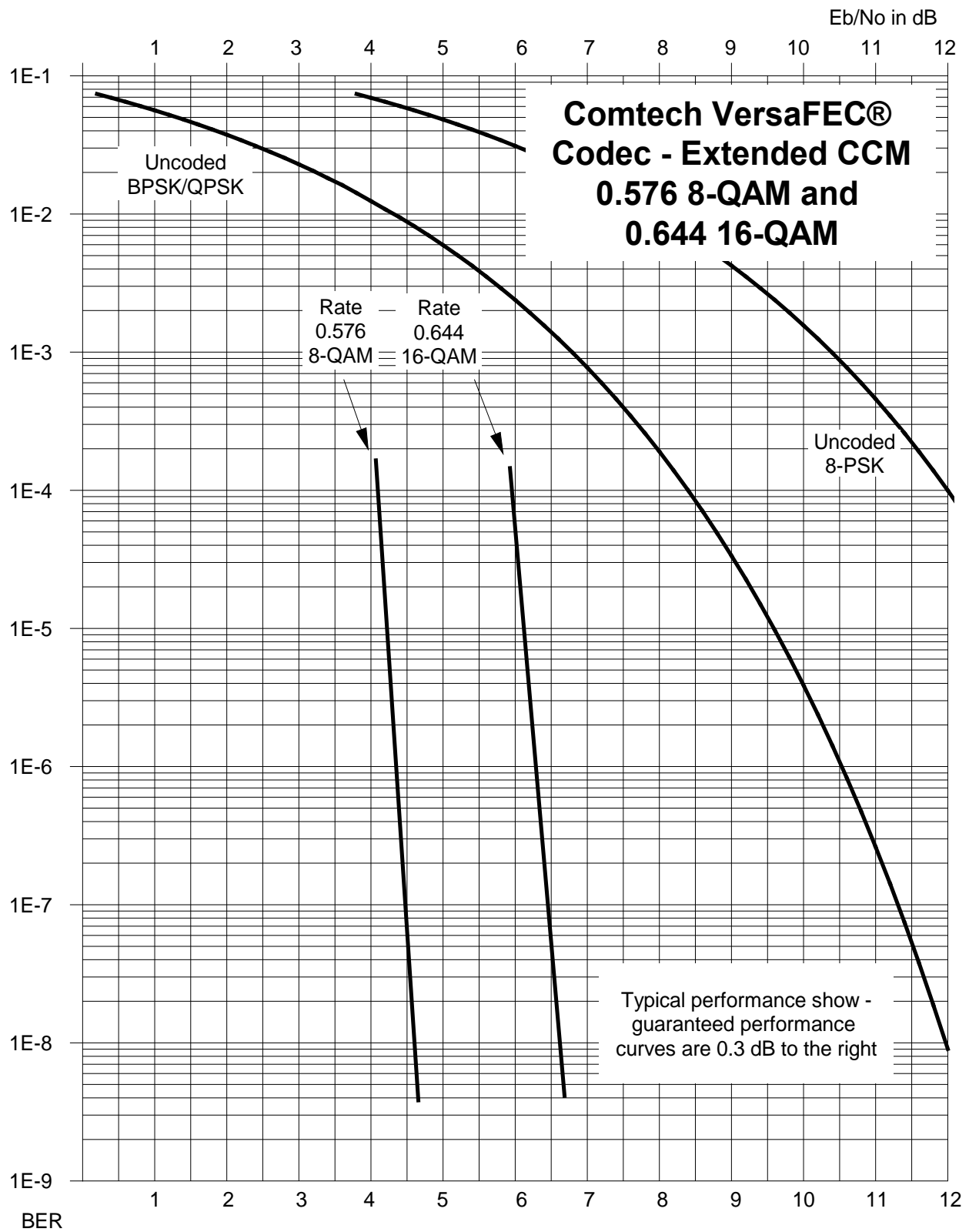

Figure B-23. VersaFEC Codec Extended CCM Rate 0.576 8-QAM and Rate 0.644 16-QAM

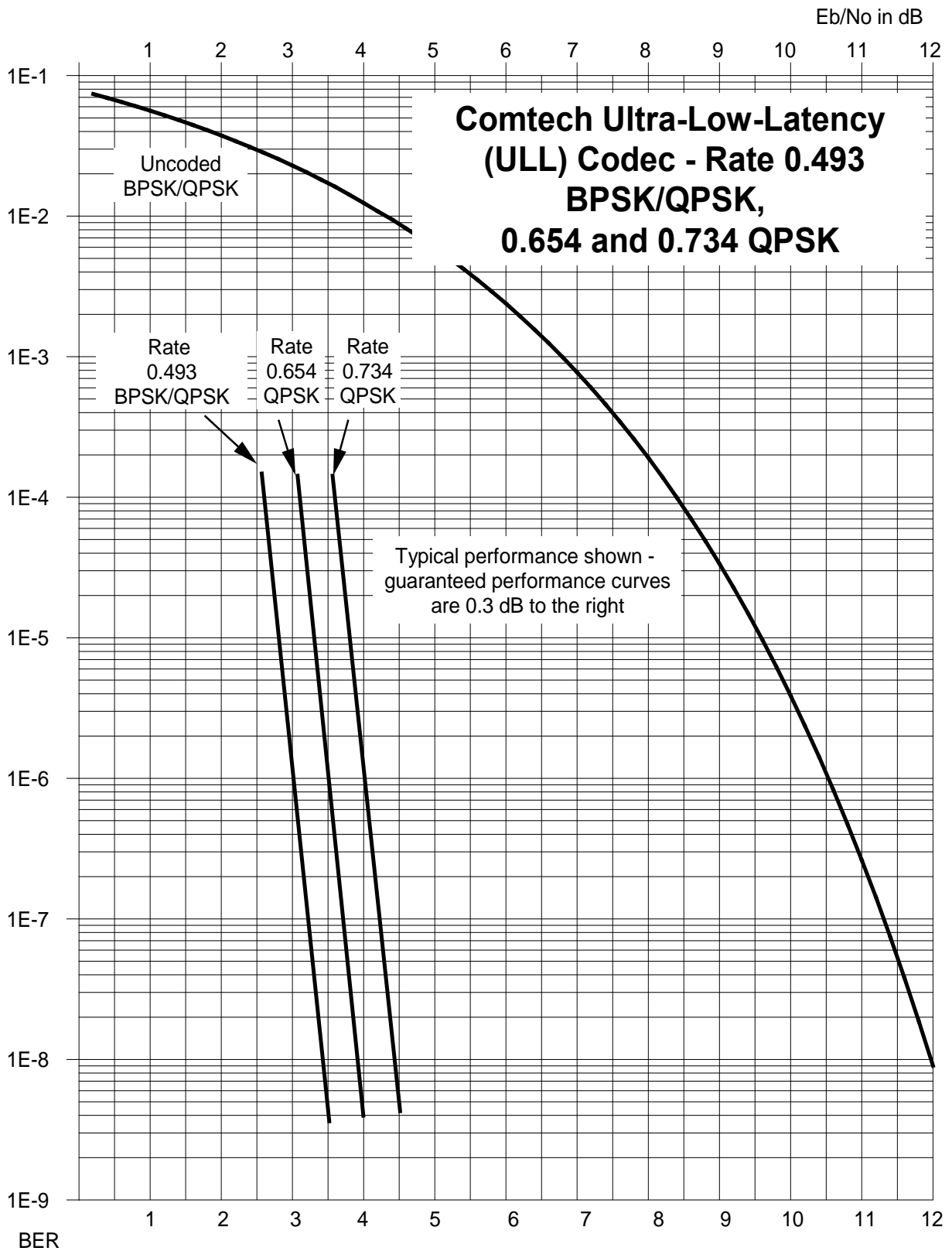

Figure B-24. ULL Codec Rate 0.493 BPSK/QPSK and Rates 0.654 and 0.734 QPSK

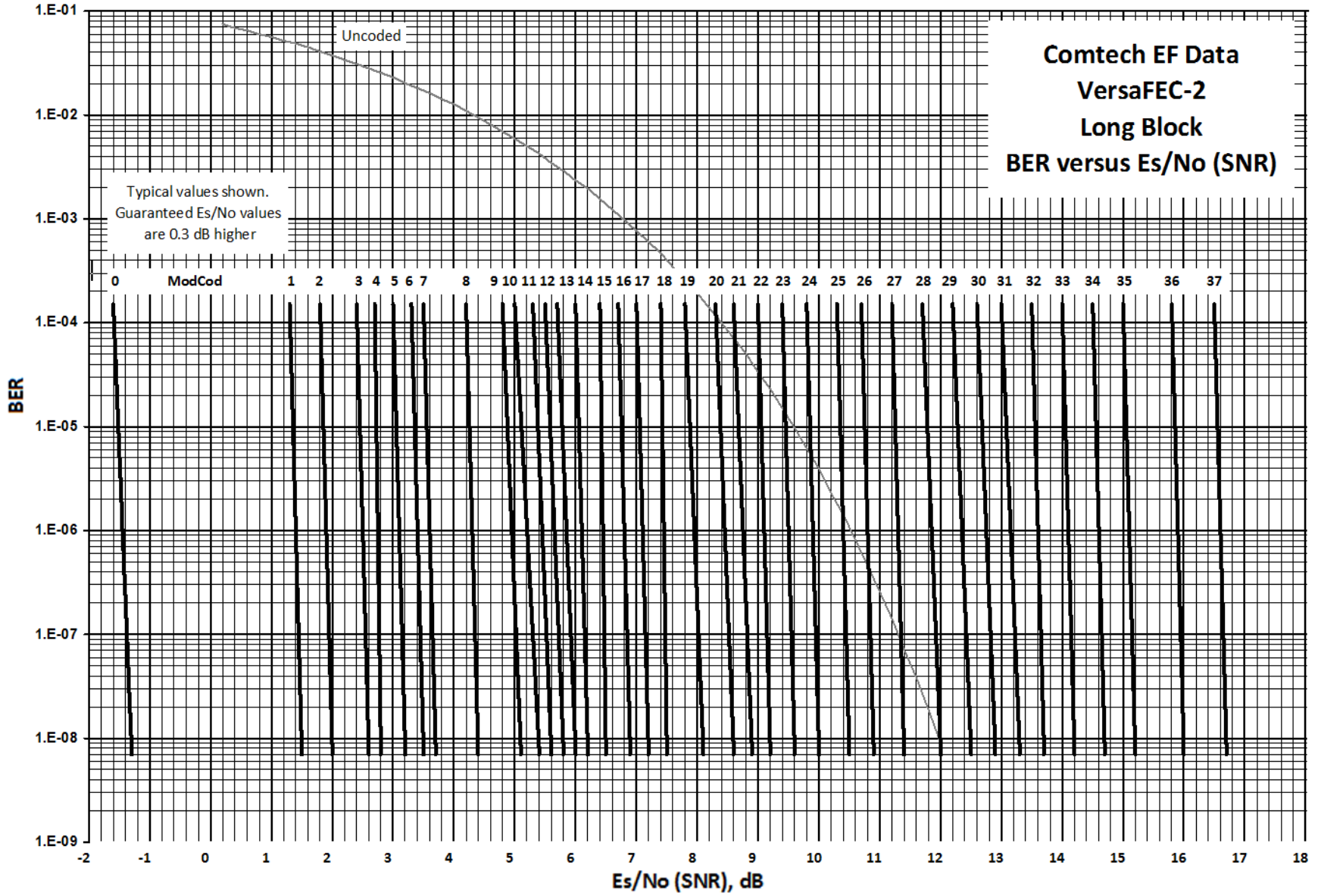

Figure B-25. VersaFEC-2 Short Block

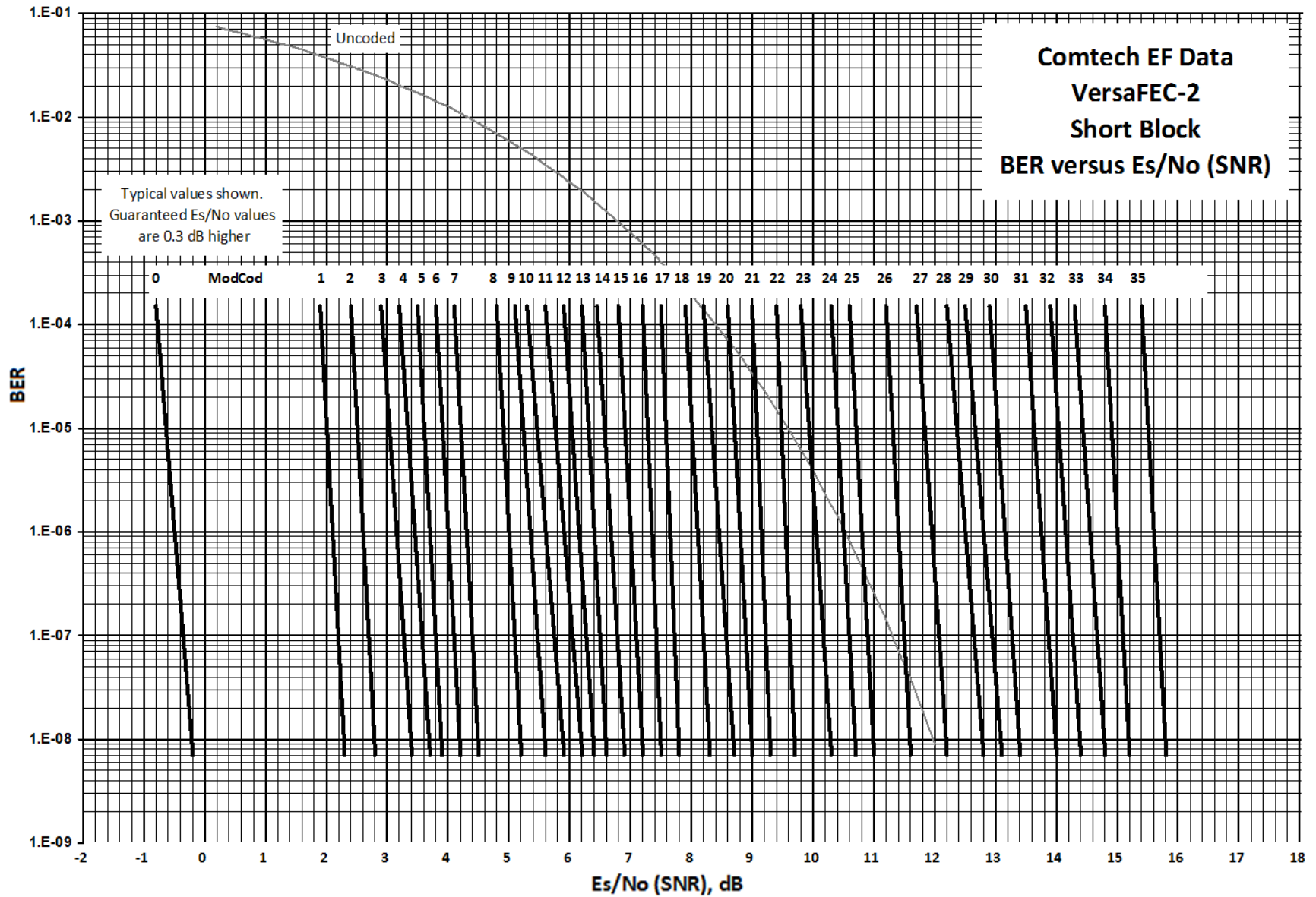

Figure B-26. VersaFEC-2 Short Block

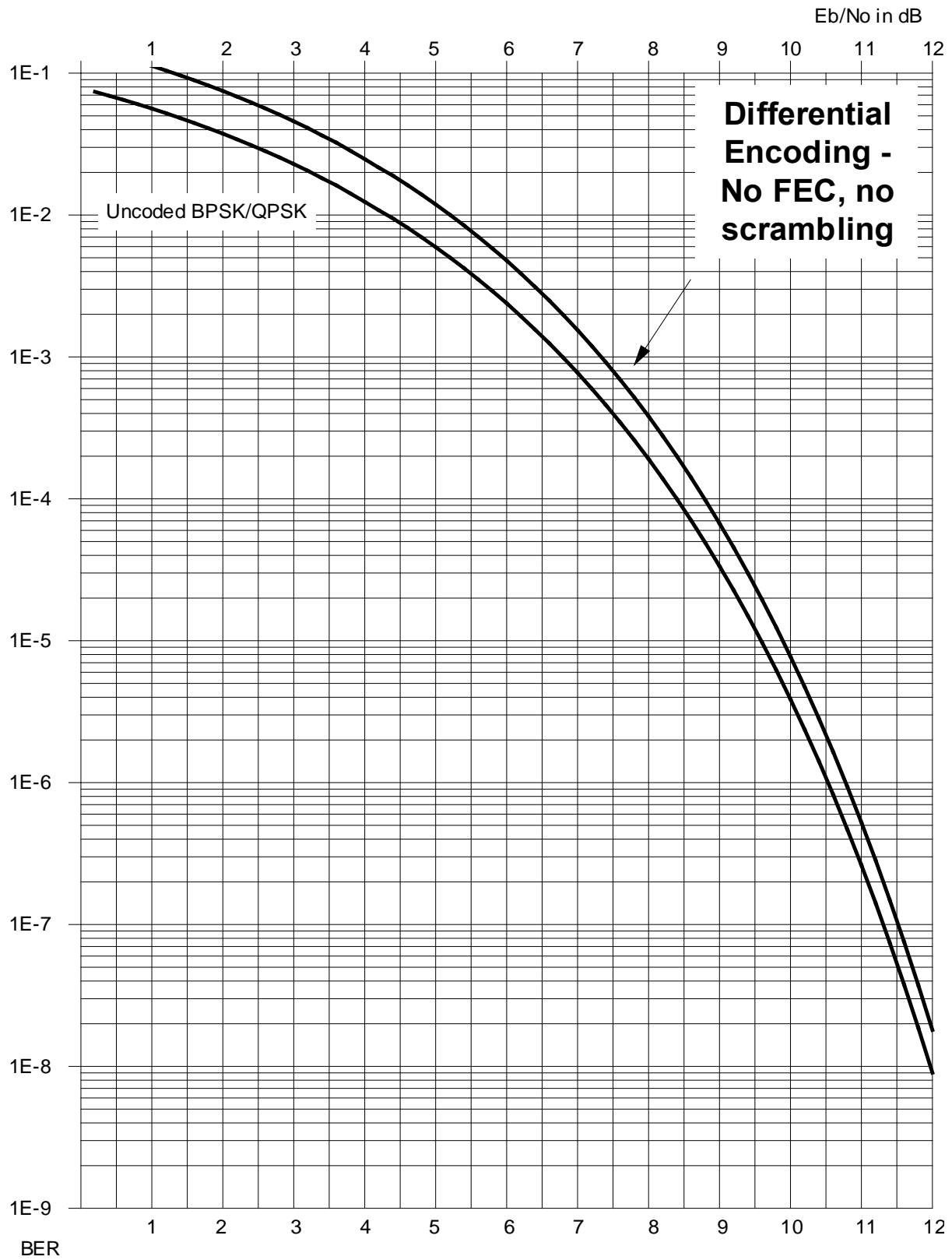

Figure B-27. Differential Encoding – No FEC, No Scrambling

Appendix C. AUPC (AUTOMATIC UPLINK POWER CONTROL)

C.1 AUPC Overview



WARNING! YOU MUST OBTAIN PERMISSION FROM THE SATELLITE OPERATOR TO USE THIS FEATURE. IMPROPER USE OF THIS FEATURE COULD RESULT IN A TRANSMITTING TERMINAL SERIOUSLY EXCEEDING ITS ALLOCATED FLUX DENSITY ON THE OPERATOR'S SATELLITE. THIS COULD PRODUCE INTERFERENCE TO OTHER CARRIERS, AND COULD CAUSE TRANSPONDER SATURATION PROBLEMS.

AUPC is the acronym for **A**utomatic **U**plink **P**ower **C**ontrol. This feature permits a local modem to adjust its own output power level in order to attempt to maintain the E_b/N_0 at the remote modem. To accomplish this, you must use one of the following framing types if not running in IP-ACM Mode:

- EDMAC, EDMAC-2, or EDMAC-3
- D&I++
- ESC++
- Framed QDI



If IP-ACM mode is selected, no additional framing is required.

The remote modem constantly sends back information about the demodulator E_b/N_0 using reserved bytes in the overhead structure. The local modem then compares this value of E_b/N_0 with a pre-defined target value. If the Remote E_b/N_0 is below the target, the local modem will increase its output power, creating a closed-loop feedback system over the satellite link. A particularly attractive benefit of this feature is that, whenever framed operation is selected, the remote demodulator's E_b/N_0 can be viewed from the front panel display of the local modem. Note that both EDMAC and AUPC can be used simultaneously with either framing type.

There are several important parameters associated with this mode of operation. You must understand how the AUPC feature works, and what the implications are for setting these parameters.

C.2 Setting AUPC Parameters

The important consideration is that *EDMAC framing should be enabled*.

- 1) Use the **SELECT: Configuration → Mode** menu to first select **EDMAC** framing. You may select **EDMAC** as **IDLE**, or define the unit as an **EDMAC Master** or **Slave**.
- 2) Verify that the remote modem *also* has EDMAC framing enabled.
- 3) Set the nominal output power of the modem: Use the **SELECT: Configuration → Tx → POWER** menu to select **MANUAL** mode, and then edit the displayed Tx output power level.
- 4) Select **AUPC** as the operating mode. At this point, you are prompted to define four key parameters: **Target Eb/No**, **Max Range**, **Alarm**, and **Demod Unlock**.

C.2.1 Target Eb/No

This is value of Eb/No that you need to keep constant at the remote modem:

- The minimum value to enter is 0.0 dB. If the Eb/No falls below this value, the AUPC control will increase the Tx output power, but will never exceed the value determined by the parameter **MAX RANGE**.
- The maximum value to enter is 14.9 dB. If the Eb/No exceeds this value, the AUPC control will reduce the Tx output power, but will never drop below the nominal value set.
- The default value is 3.0 dB.
- The resolution is 0.1 dB.



If IP-ACM mode is selected, then the larger Eb/No value does not need to be specified. The combined AUPC/ACM algorithm does not require this parameter.

C.2.2 Max Range

This defines how much the modem is permitted to increase the output level, under AUPC control:

- The minimum value to enter is 0 dB.
- The maximum value to enter is 9 dB.
- The default value is 1 dB.
- The resolution is 1 dB.

C.2.3 Alarm

This defines modem behavior if the maximum power limit is reached while under AUPC control. The two choices are:

- **NONE** (no action) – **default setting**.
- **Tx ALARM** (generate a Tx alarm).

C.2.4 Demod Unlock

This defines the action the modem will take if the remote demodulator loses lock. The two choices are:

- **NOMINAL** (reduce the Tx Output Power to the nominal value) – **default setting**.
- **MAXIMUM** (increase the Tx Output Power to the maximum value permitted by the parameter **MAX RANGE**).



If the local demod loses lock, then the modem automatically moves its output power to the nominal value.

C.3 Compensation Rate

As with any closed-loop control system, you must choose loop parameters that ensure stability at all times. Several features ensure that the AUPC system does overshoot, or oscillate:

- First, corrections for which the output power can be made are fixed at the rate of once every 4 seconds. This takes into account the round trip delay over the satellite link, the time taken for a power change to be reflected in the remote demodulator's value of E_b/N_0 , and other processing delays in the modems.
- Second, if the comparison of actual and target E_b/N_0 yields a result that requires a change in output power, to avoid the possibility of overshoot the first correction made will be at 80% of the calculated step. Subsequent corrections are made until the difference is less than 0.5 dB. At this point, the output power is only changed in increments of 0.1 dB to avoid 'hunting' around the correct set point.

C.4 Monitoring



CAUTION – Comtech EF Data strongly cautions against the use of large values of permitted power level increase under AUPC control. Users should consider using the absolute minimum range necessary to improve rain-fade margin.

The remote demodulator's value of E_b/N_0 can be monitored at all times, either from the front panel (**SELECT: Monitor → AUPC**) or via the remote control interface. The resolution of the reading is 0.2 dB. For all values greater than or equal to 16 dB, a value of 16.0 dB will be displayed. As long as framing is enabled, the value will still be available, even though AUPC may be disabled.

The current value of Tx power increase is also displayed. If EDMAC framing is enabled but AUPC is disabled, this will indicate 0.0 dB. This value is also available via the remote control interface.



If IP-ACM mode is selected, then distant-end E_b/N_0 monitoring is done through the ACM monitor functions. In the IP-ACM case, the displayed resolution is 0.1 dB.

Appendix D. CARRIER ID (DVB-CID METACARRIER[®])

D.1 Overview

CDM-625A Advanced Satellite Modems incorporate a patent-pending carrier identification (CID) technique that uses MetaCarrier[®] spread spectrum technology to embed a unique carrier identification sequence for the transmitted carrier.

The CDM-625A with MetaCarrier[®] is used in tandem with the Comtech EF Data MCDD-100 MetaCarrier[®] Detection Device to provide a complete MetaCarrier embedding and decoding solution.

Since the initial release of this technology in the CDM-625A, the European Telecommunications Standards Institute (ETSI) has adopted a modified version of Comtech's original scheme, which is defined in **ETSI TS 103 129 – Digital Video Broadcasting (DVB) Framing Structure, Channel Coding and Modulation of a Carrier Identification System (DVB-CID) for Satellite Transmission**. CDM-625As running Firmware Version 1.2.1 or later fully comply with this new ETSI specification.

D.2 About MetaCarrier

The DVB-CID (MetaCarrier) concept employs a low-speed data sequence containing identifying information about a host carrier that is spread using Direct Sequence Spread Spectrum (DSSS), and then combined, at a low power level, directly underneath that host carrier. The composite signal therefore carries its own embedded identification. The power level and bandwidth of the MetaCarrier is sufficiently low that it is completely hidden below the host carrier, and has minimal effect on system E_b/N_0 (approximately 0.1 dB).

DVB-CID operates independent of the modulation and Forward Error Correction (FEC) rate of the host carrier. In configurations where the carrier is encrypted or uses cryptographic technologies, the information carried in the DVB-CID is not affected.

Traditionally, the method for identifying an interfering carrier involves using a geo-location system that, in turn, uses the phase offset from an adjacent satellite to triangulate the approximate location on the surface of the earth where the interference is being generated. While such "tried-and-true" geo-locating methods have proven beneficial to satellite operators

and service providers, they are nevertheless imprecise. For example, to find the exact location of the transmission source in a densely populated area, you must dispatch a helicopter equipped with a feed horn and spectrum analyzer; the time and cost associated with such methods are significant.

By contrast, Comtech EF Data’s DVB-CID provides you with the interference source’s identification information within seconds. Once you identify the offending carrier, you may then contact the uplinking station and request that the station shut down or otherwise remove the identified transmission from service.

D.3 Functional Description

In a typical network, there can be many CDM-625As with DVB-CID, and one (or more) MCDD-100 MetaCarrier Detection Devices to verify the presence of the DVB-CID on each carrier. In an interference situation, the MCDD-100 may be used to decode the DVB-CID of an interfering carrier that may not be part of one’s own transmission network, as long as the interfering carrier has an embedded DVB-CID.

The CDM-625A creates a composite carrier by first sizing the appropriate MetaCarrier, and then by adding the spread spectrum CID (at a highly reduced power spectral density compared with that of the host carrier).

The size of the MetaCarrier is determined based purely on symbol rate and is totally independent of modulation and coding, resulting in two (2) discrete sizes of MetaCarrier being combined with the host carrier. The MetaCarrier parameters are shown below:

Host Carrier	Embedded DVB-CID MetaCarrier	DVB-CID psd relative to host carrier psd
128 ksps to < 512 ksps	112 kchips per sec *	-27.5 dB
512 ksps to < 2048 ksps	224 kchips per sec	-27.5 dB
2048 ksps to < 4096 ksps	224 kchips per sec	-24.5 dB
4096 ksps to < 8192 ksps	224 kchips per sec	-21.5 dB
8192 ksps to 12500 ksps	224 kchips per sec	-18.5 dB

*kchips per sec refers to the direct sequence spread spectrum chipping rate

As shown here, the bandwidth of the host carrier is always wider than the MetaCarrier, the worst case being a 112 kcps MetaCarrier underneath a 128 ksps host carrier. In all configurations of the combined carrier, the MetaCarrier raises the transmission power less than 0.1 dB above the original carrier.



Note that in accordance with the DVB specification, Carrier ID is only available when the Transmit symbol rate is greater than, or equal to 128 ksps.

The CID message is composed of the following information:

- CDM-625A MAC Address
- Contact Telephone number
- Latitude and Longitude
- Custom message

D.4 Configuring the CDM-625A for Carrier ID Operation

Carrier ID operation requires that you first enable Carrier ID feature operation, and then create a MetaCarrier Custom Message. All other parameters (center frequency, symbol rate, and the CDM-625's MAC address) are set automatically. The CDM-625A provides several means for configuring Carrier ID operation:

- Local Control via the CDM-625A Front Panel keypad and VFD.
- Remote Control with a user-supplied PC via the
 - CDM-625A HTTP (Web Server) Interface using a compatible Web browser.
 - Serial-based or Telnet-based Remote Control Interface using a terminal emulation program or Windows Command-line.
 - Ethernet-based Simple Network Management Protocol (SNMP) using a Network Management System (NMS) and Management Information Base (MIB) File Browser.



USE OF THE SERIAL-BASED REMOTE CONTROL INTERFACE, THE TELNET-BASED REMOTE CONTROL INTERFACE, AND THE ETHERNET-BASED SNMP INTERFACE ARE RECOMMENDED ONLY FOR ADVANCED USERS. COMTECH EF DATA STRONGLY ENCOURAGES USE OF THE CDM-625A FRONT PANEL OR HTTP (WEB SERVER) INTERFACE FOR MONITOR AND CONTROL (M&C) OF THE CDM-625A.

D.4.1 Enabling Carrier ID Operation

D.4.1.1 Enabling Operation via the CDM-625A Front Panel and VFD



Sect. 6.2.6.3 Utilities: CarrID (Chapter 6. FRONT PANEL OPERATION)

From the front panel main (**SELECT:**) menu, use the ◀▶ arrow keys to select the **Utility** menu branch, and then press **ENTER**. Then, from the **Utilities:** screen, use the ◀▶ arrow keys to select the **CarrID** submenu. Press **ENTER** to continue (the flashing solid block indicates the cursor position upon navigation to that display item):

```
SELECT: Configuration Test Monitor
Info Store/Ld Utility ODU FAST (◀ ▶)
```

```
Utilities: Set-RTC Display-Bright CarrID
LED Redundancy Circuit-ID Firmware Em
```

```
CarrierID:On (Off,On) For Tx>128ksps (◀ ▶ ⬇)
Latitude Longitude Telephone Message
```

Use the ▲▼ arrow keys to select Carrier ID (MetaCarrier) operation as **On**, and then press **ENTER**.

You are then prompted to enter user supplied data, as follows:

```
CarrierID:Latitude 33025.43' N      (◀ ▶ ⏏)
```

Edit the latitude (in the form shown – degrees and decimal minutes, North or South) of the location where the CDM-625A is located using the ▲▼ arrow keys, then press **ENTER**.

```
CarrierID:Longitude 111056.28' W   (◀ ▶ ⏏)
```

Edit the longitude (in the form shown – degrees and decimal minutes, East or West) of the location where the CDM-625A is located using the ▲▼ arrow keys, then press **ENTER**.

```
CarrierID Telephone Number:      (◀ ▶ ⏏)  
----- +18664723963 -----
```

Enter the telephone number of the person or entity to be contacted in the event that there is an interference problem, using the ▲▼ arrow keys, then press **ENTER**.

```
CarrierID:Custom message:      (◀ ▶ ⏏)  
----- Comtech EF Data -----
```

Enter the custom message that you want to be associated with the particular CDM-625A satellite link, using the ▲▼ arrow keys, then press **ENTER**.

Appendix E. CLOCK MODES AND DROP AND INSERT (D&I)

E.1 Overview

When dealing with satellite modems, the subject of clocking can be a complex issue. This appendix describes the various clocking options that are available with the CDM-625A.

The CDM-625A provides two fundamentally different interfaces:

- Synchronous clock and data interfaces (EIA-422, V.35, etc.) that permit great flexibility concerning the source and direction of clocks. These cause the most confusion.
- G.703 interfaces, in which the clock and data are combined into a single signal (and are referred to as *self-clocking*). In their basic form, these are less flexible and therefore easier to understand. However, when used with Drop and Insert operation, the subject again becomes more complex.

E.2 Transmit Clocking

There are five transmit clocking modes in the CDM-625A. EIA-422/449 signal mnemonics will be used for illustration, but the description applies equally to V.35, HSSI, and LVDS. **Figure E-1** provides a graphic depiction of these modes.

E.2.1 Internal Clock

In this mode, the modem, assumed always to be the DCE, supplies the clock to the DTE. (The EIA-422/449 name for this signal is Send Timing, or ST.) The DTE then clocks from this source, and gives the modem transmit data (Send Data, or SD) that is synchronous with this clock. It is optional whether the DTE also returns the clock (Terminal Timing, or TT) – the modem can accept it if it is present, but uses ST if it is not. At rates above 2 Mbps, Comtech EF Data highly recommends that you return TT to ensure the correct clock/data relationship.

G.703 and ASI: The internal clock mode does not apply – the clock is always recovered from the incoming signal, and the modem locks its modulator clocks to this.

IP and Audio: This is the only available mode.

E.2.2 TX Terrestrial

In this mode, the modem expects to see the DTE provide the clock so that it can phase-lock its internal circuits. In this case, the modem does not provide any signal on ST, but instead requires a clock signal on Terminal Timing (TT) that is synchronous with the data. If no clock is present, an alarm will be generated and the modem will substitute its internal clock.

G.703 and ASI: This is the 'natural' clock mode.

IP and Audio: Does not apply.

E.2.3 RX Loop-Timed, RX=TX

In certain circumstances, a terminal at the distant-end of a satellite link may be required to provide a clock to the DTE equipment that is locked to the receive satellite signal. This is similar to Internal Clock mode in that the modem will source Send Timing (ST) to the DTE, but now the timing is derived from the demodulator. The DTE then clocks from this source and gives the modem transmit data (Send Data, or SD) that is synchronous with this clock. It is optional whether the DTE also returns the clock (Terminal Timing, or TT) – the modem can accept it, if it is present, but uses ST if it is not. If the demodulator loses lock, the modem's internal clock will be substituted, so an accurate and stable clock is present on ST rather than a clock that may jitter and wander in a random fashion.

G.703, ASI, IP and Audio: Does not apply.

E.2.4 RX Loop-Timed, RX<>TX (Asymmetric Loop Timing)

The CDM-625A incorporates circuitry that permits loop timing when the TX and RX data rates are not the same. In this case, the clock frequency appearing at ST will be whatever the TX data rate is programmed to, but will be phase-locked to the demodulator's receive symbol clock. In all other respects, the operation is the same as for 'standard' loop timing.

G.703, ASI, IP and Audio: Does not apply.

E.2.5 External TT with ST = RX Satellite

This is a special case that addresses a particular need for backwards compatibility with the SDM-300A modem. It is, in many ways, similar to the standard TX Terrestrial mode described in **Sect. 9.2.2** in that, in this mode, the signal appearing on TT is used to provide the timing reference for the transmit side of the CDM-625A. However, in this mode the ST pins on the interface are active and provide a copy of the RX Satellite clock (i.e., the clock from the demodulator, prior to the buffer).

This mode is subject to certain limitations:

- RX and TX data rates must be identical.

- No framing (EDMAC, etc.) may be used.
- No RS coding may be used.
- RS-422, V.35, HSSI, and LVDS are the only interfaces supported and used on the Type 'D' 25-pin connector.

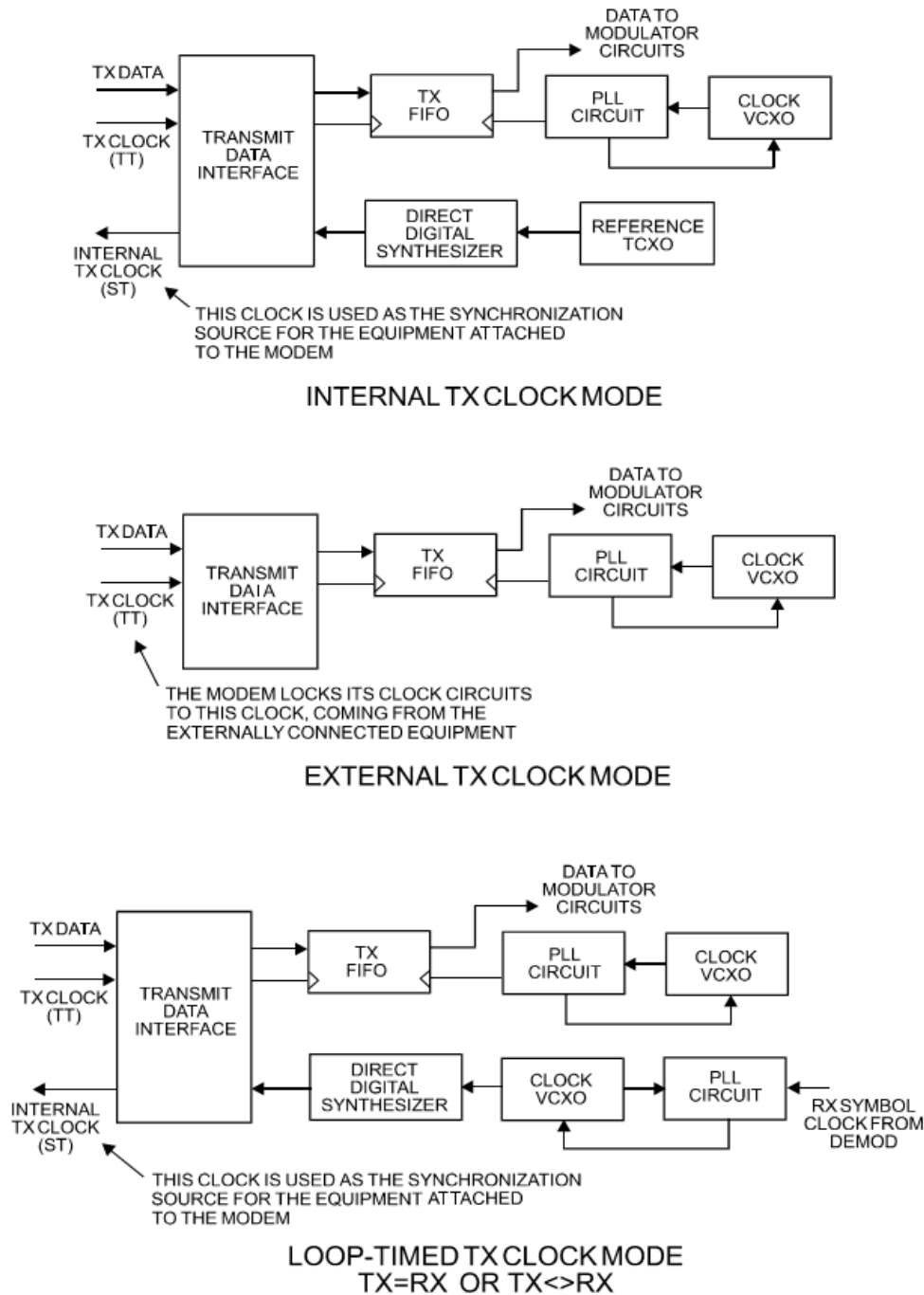

Figure E-1. TX Clock Modes

E.3 Receive Clocking

There are three receive clocking modes in the CDM-625A: Buffer Disabled (RX Satellite), Buffer Enabled (TX=RX), and Buffer Enabled (RX< >TX). An additional setting used only for Drop and Insert is described in further detail later in this appendix. **Figure E-2** provides a graphic depiction of these modes.

E.3.1 Buffer Disabled (RX Satellite)

When the buffer is disabled, the receive clock (Receive Timing, or RT) is derived directly from the demodulator, and will therefore be subject to plesiochronous and Doppler offsets. This may be acceptable in certain instances. There is still a minimum buffer in use to de-jitter the effects of removing overhead framing.

G.703: Applicable.

E.3.2 Buffer Enabled, TX=RX (TX Terrestrial or Int (SCT) Clock)

In this instance, it is required that the buffer be enabled, so that the clock and data appearing on Receive Timing and Receive Data (RT and RD, respectively) are synchronous with the transmit clock or the internal (SCT) clock. This is a relatively simple case, as the output clock for the buffer is derived directly from ST, TT, or the external source.

G.703: Applicable.

E.3.3 Buffer Enabled, RX<>TX (TX Terrestrial or Int (SCT) Clock)

This is an uncommon case, where the receive data rate does not equal the transmit or external reference. The modem will generate a phase-locked buffer output clock that uses the selected reference, regardless of its frequency in relation to the receive data rate.

G.703: Applicable.

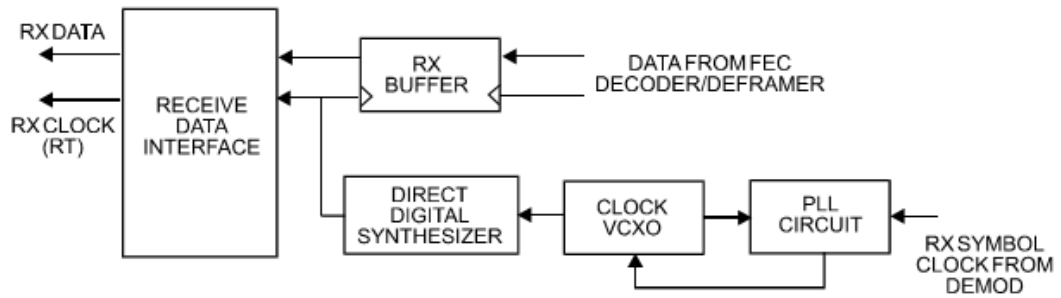

BUFFER DISABLE CLOCK MODE

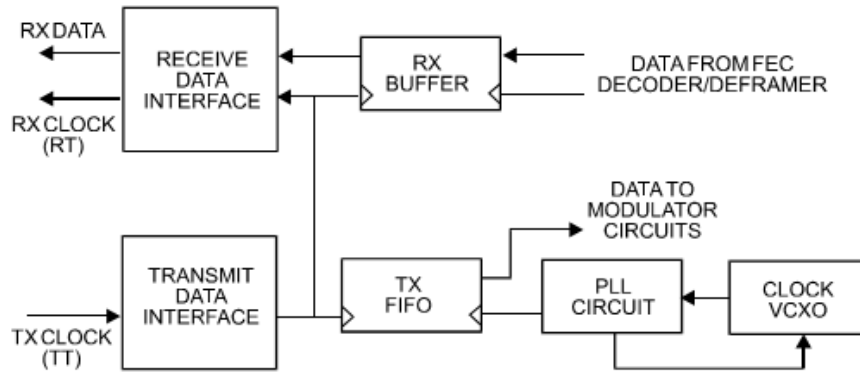

**BUFFER ENABLE
TX = RX CLOCK MODE**

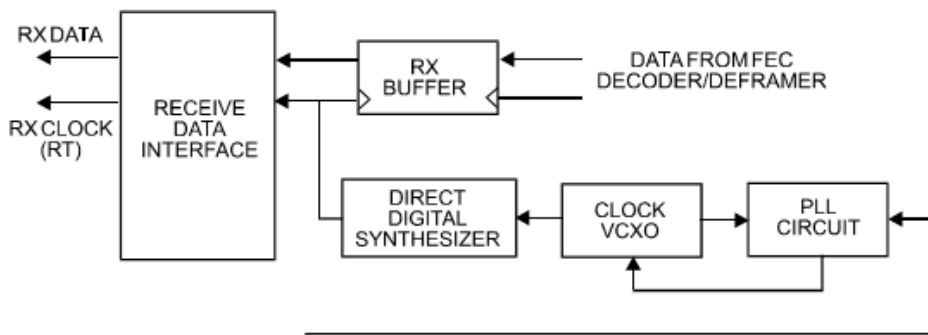

**BUFFER ENABLE
TX <=> RX CLOCK MODE**

Figure E-2. RX Clock Modes

E.4 X.21 Notes

The central feature of X.21 is that the DCE supplies the clock for both directions. Therefore, the first requirement is that TX and RX data rates are the same. Because the DCE doesn't get an input clock moving in the same direction as its input data, the several nanoseconds of delay through long cables and the modem's data transceivers can cause the clock phase to change relative to the data. This is why X.21 is not recommended above 2048 kbps.

If **Modem = DCE** (normal assumption), then X.21 mode is just a matter of ignoring ST and TT and, instead, using RT to run both directions. Using the clock settings **TX Clk = Loop and RX Buffer Clk = RX** assumes that the desired timing is coming from the far-end modem. The modem's ST is forced to be a copy of RT, because the latter assumes use by the terrestrial DTE to drive SD data into the modem.

If, instead, the local modem supplies the timing, the clock settings should be **TX Clk = Int and RX Buffer Clk = TX or Int**. These settings instead force RT to be a copy of ST. In either case, it is SD that has an uncertain phase relationship to the clock due to round-trip delays, so the modem's TX clock invert feature may be necessary to avoid clocking in SD on its transitions.

If **Modem = DTE**, then ST and RT are ignored, and TT from the terrestrial DCE is used. The correct modem settings are **TX Clk = TT and RX Buffer Clk = TX**. These settings force RT (which drives out the modem's RD) to be a copy of TT. It is now RD that has an uncertain phase relationship to the clock, so the modem's RX clock invert may be necessary to please the terrestrial DCE.

E.5 Drop and Insert

The Drop and Insert (D&I) multiplexer works in conjunction with the G.703 interfaces to enable the modem to transmit or receive fractional parts of a T1 or E1 data stream.

The D&I option provides fully compliant baseband processing in accordance with Intelsat IESS-309 for the terrestrial information rate of 2048 kbps (E1) and 1544 kbps (T1), using G.703 interfaces. The data rate sent over the satellite link is $n \times 64$ kbps. See the Frame Formats diagram for the permissible values of n . The modem provides the interface to transmission level framing compliant to IESS-309 Data Type 2.

E.6 Frame Formats

Figure E-3 shows the supported E1 and T1 Frame Formats. Note that, for D&I++, the smaller overhead frame structure does not support CAS signaling, although E1 timeslot 16 may still be one of the channels transmitted.

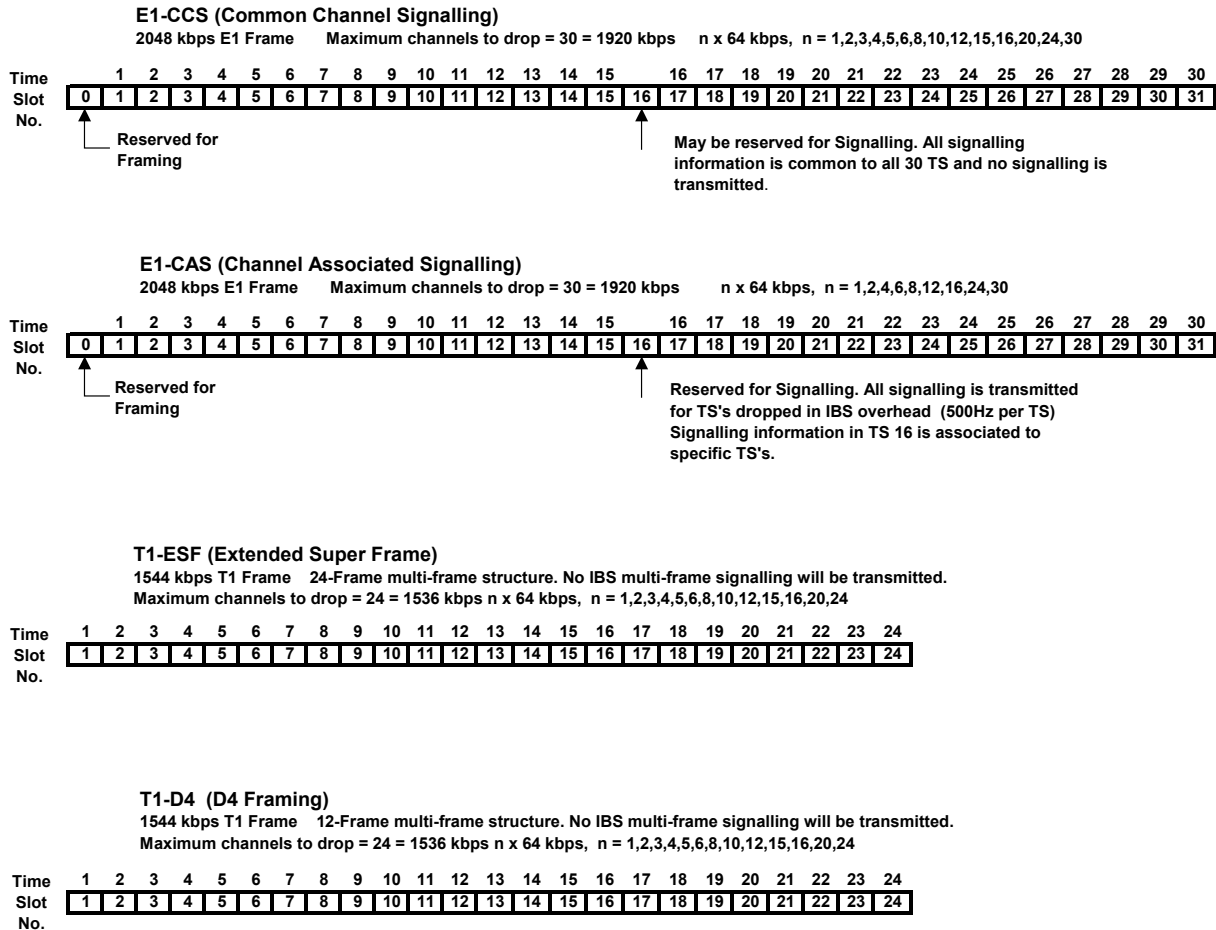

Figure E-3. Supported T1 and E1 Framing Formats

E.7 Timeslot Selection

Selection of the transmit and receive data rates may be made in certain 64 kbps increments and may be independent of each other. The actual satellite rates for open network D&I are 16/15 of the transmit or receive data rate to include IBS overhead per IESS-309, although this is transparent to the user.

For E1, you can select any timeslot (TS) from 1 to 31. Selection of TS 0 *is* permitted (on the front panel menus, use 'z' to add to the list of timeslots to be dropped/inserted).

For T1, you can select any timeslot (TS) from 1 to 24. You may also select "N/A" to leave a satellite channel unused.

The configuration menu allows timeslots to be selected for transmission or reception up to the maximum dictated by the selected transmit or receive data rate, and may be selected in arbitrary order. For example, if the data rate is set to 256 kbps, the maximum number of timeslots that can be dropped or inserted is 4 (being 4 x 64 kbps).

Note that, for 1920 kbps data rate, the timeslots may not be manipulated. This is the 'fixed channel' mode where Timeslot 1 is assigned to Channel 1, and so on.

For D&I++ framing, all increments of 64 kbps are allowed up to a maximum of 31 (1984 kbps). For this mode, the satellite rate is 46/45 of the front panel data rate (2.22%).

E.8 Drop and Insert (D&I) Clocking

Figure E-4 shows the general arrangement for Drop and Insert clocking in the CDM-625A. Note that there are two inputs and two outputs shown for Drop and Insert Operation:

- Drop Data In (DDI)
- Drop Data Out (DDO)
- Insert Data In (IDI)
- Insert Data Out (IDO)

This arrangement permits you to choose between fully independent operation of the incoming and outgoing E1/T1 signal, or to use the same T1/E1 signal for both Dropping and Inserting (looped mode). If 'Loop' has been selected under the Drop and Insert configuration menu, the Drop Data Out (DDO) signal is automatically looped internally, to become the Insert Data In (IDI).

In this mode, timeslots are dropped from an incoming E1/T1 signal for transmission over the satellite, and the *same* E1/T1 signal has timeslots re-inserted into it that will over-write data in existing timeslots.

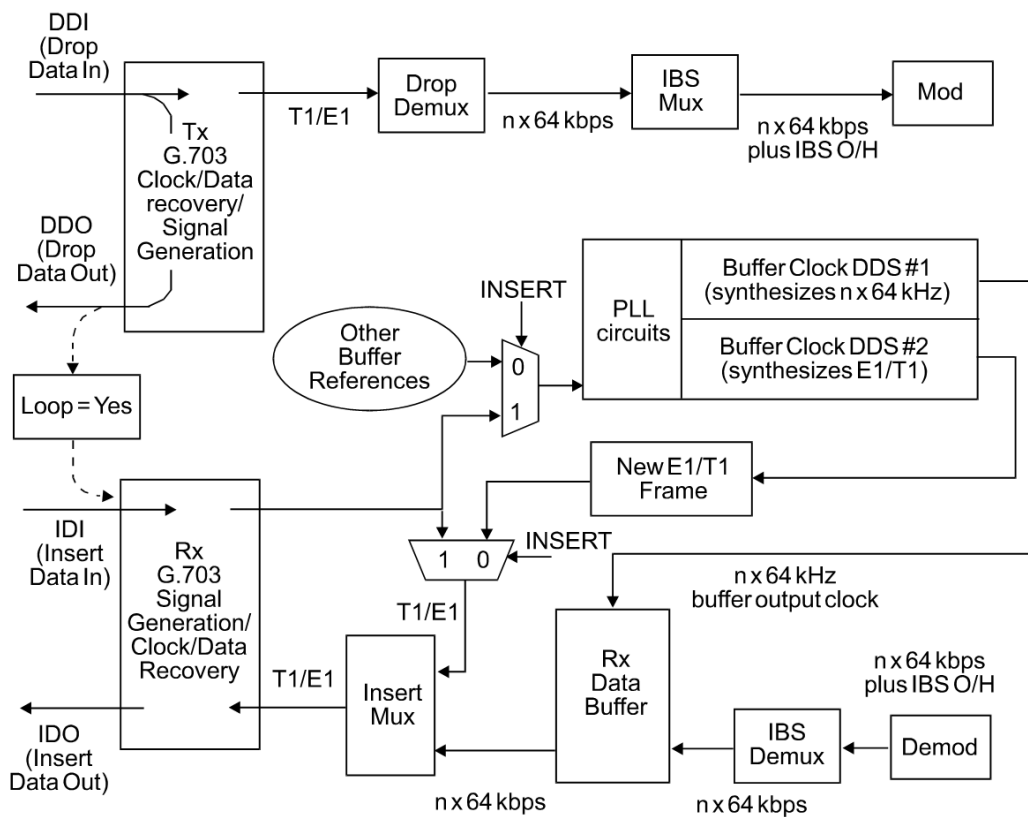

Figure E-4. Drop and Insert Clocking

E.9 RX Buffer Clock = Insert (D&I only)

The E1 or T1 clock recovery from the IDI G.703 port serves as the RX Buffer reference. In addition, the recovered data is the E1/T1 input to the Insert Mux. If the RX G.703 recovery circuit detects no activity at IDI input, or cannot detect the expected frame format, Buffer Clock = RX Satellite will be chosen as a fall-back.

If 'Insert' is *not* the selected buffer clock reference, the clock and data from the IDI port is ignored, and a new E1/T1 frame is generated. The timeslots coming from the satellite are then re-inserted into the selected timeslots of this new blank frame, and output on the IDO port.

E.10 Single-Source Multiple Modems

Two ways to connect a single T1 or E1 stream to several modems are by looming or daisy-chaining modems. Looming method is illustrated in **Figure E-5**, while **Figure E-6** illustrates the daisy-chain method – each requires the **RX Buffer Clock = Insert** setting. Note the following:

- Assign all timeslots to not overlap.
- Assign modems to number of TX/RX channels as required.

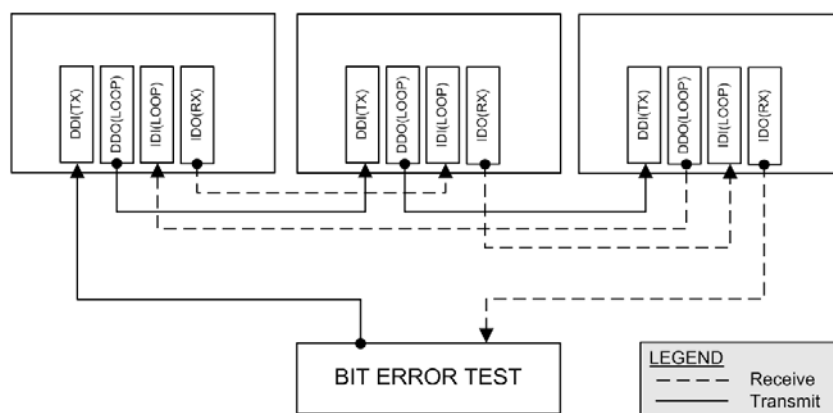

Figure E-5. Single-Source Multiple Modems (Looming)

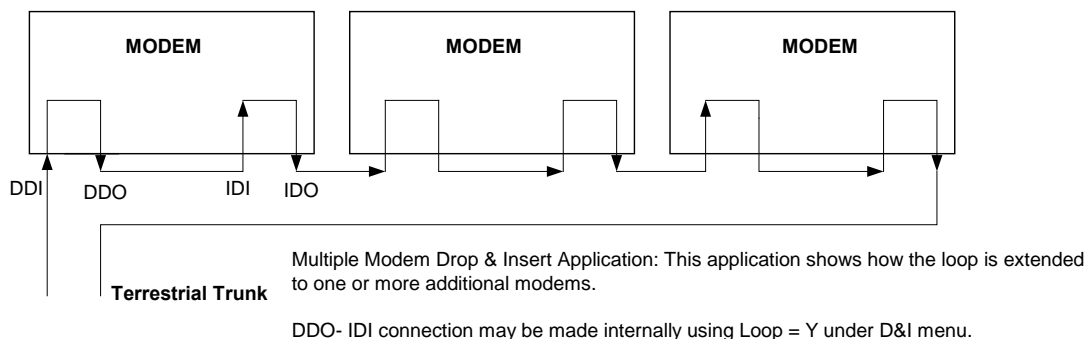

Figure E-6. Single-Source Multiple Modems (Daisy-chain)

E.11 G.703 Clock Extension

There are some applications where it becomes necessary, at the distant end of a satellite link, to provide a high-stability G.703 timing reference for timing equipment connected to the modem. For example, in cellular backhaul applications, the BTS equipment may require such a reference ***even though the satellite link itself may be operating at a data rate other than 1.544 Mbps or 2.048 Mbps***. This is sometimes accomplished by adding a specialized GPS receiver at the distant end, which then provides the G.703 synchronizing signal. However, with the G.703 clock extension mode this may become unnecessary, as the CDM-625A – operating at either end of the link, where the local modem has access to a high-stability G.703 signal – can provide an almost perfect copy of this signal at the distant end. The presence of Doppler shift on the link is the only factor affecting the overall accuracy. If Doppler shift were not present, the copy of the clock would be perfect.

This is accomplished by the use of a novel frequency synthesis and phase locking scheme. This feature of the CDM-625A permits the distant end to generate a G.703 synchronizing signal that, depending on a sufficiently accurate local reference, has short term accuracy to within parts in 10^{-8} , and is solely dependent on link Doppler shift.

The subsections and figures that follow illustrate three possible G.703 clock extension modes. Details of how to set up the modems for these various operating modes are given in **Chapter 6. FRONT PANEL OPERATION.**

E.11.1 Clock Extension Mode 1

Figure E-7 shows Clock Extension Mode 1. The local modem is assumed to be operating on INTERNAL clock. A T1 or E1 G.703 signal is applied to the rear panel connector of the modem, where the clock is recovered.

(Note: the G.703 signal is not intended to convey data – its function is only to provide a synchronizing clock. The data is transferred using the EIA-530/V.35 serial interface.)

The internal clock reference generator locks – in both frequency and phase – to this recovered clock, and a special synthesizer generates an ST clock of ANY ARBITRARY FREQUENCY over the range 2.4 kHz to 9.98 MHz with a resolution of 1 Hz. The synthesis is exact – there is no approximation or residual error. For example, if you select 168.231 kbps as the transmit data rate, and an E1 reference, there will be *exactly* 168,231 clock cycles generated for every 2,048,000 cycles of the E1 reference.

The internal ST clock is now used, as in the standard Internal Clock mode, to provide the timing reference for the externally-connected equipment. The data is then transmitted at the desired data rate to the distant end (or distant ends – this works for broadcast applications as well).

Now, at the distant end modem (timing mode: RX Satellite), the RX signal is received, demodulated, and the clock is recovered. A second synthesizer, very similar to the one used at the local modem, is now used to generate an E1 or T1 timing signal. Again, it should be

emphasized that the synthesis is *exact*. The net result is that the E1 or T1 timing signal used at the local end is reproduced at the distant end, *regardless of the link data rate*.

The only thing that affects the overall accuracy and stability of the copy of the clock is the Doppler shift of the link itself. This will be very dependent on the particular satellite used, and the accuracy of the orbital station keeping (often referred to as orbital inclination). Typically the Doppler variations are in the order of parts in 10^{-8} , but more importantly it should be recognized that, over a 24 hour period, the net error would be zero due to a fundamental characteristics of geostationary orbits.

The T1 or E1 signal, available on the rear panel of the modem on the G.703 connectors, is now used to provide a synchronizing source for equipment connected to the modem. The form of this is an 'all ones' signal, which provides the maximum transition density in the AMI signal.

Note: This scheme is sufficiently flexible to permit an E1 signal to be used at the local end, and a T1 signal to be reproduced at the distant end, or *vice versa*.

E.11.2 Clock Extension Mode 2

Figure E-8 shows Clock Extension Mode 2. This is for situations where clock extension needs to be performed, but there is no local G.703 reference. In this case, the local modem now operates in an EXTERNAL clock mode and the accuracy of the TX Clock is determined solely by the accuracy of the equipment connected to the modem.

At the distant end, an E1 or T1 synchronizing signal is generated *regardless of the link data rate*, as in Mode 1.

E.11.3 Clock Extension Mode 3

Figure E-9 shows Clock Extension Mode 3. This is very similar to Mode 1 but now, instead of the EIA-530/V.35 serial interface being used, everything is based around the 10/100 Base T Ethernet interface.

At the distant end, an E1 or T1 synchronizing signal is generated *regardless of the link data rate*, as in Mode 1

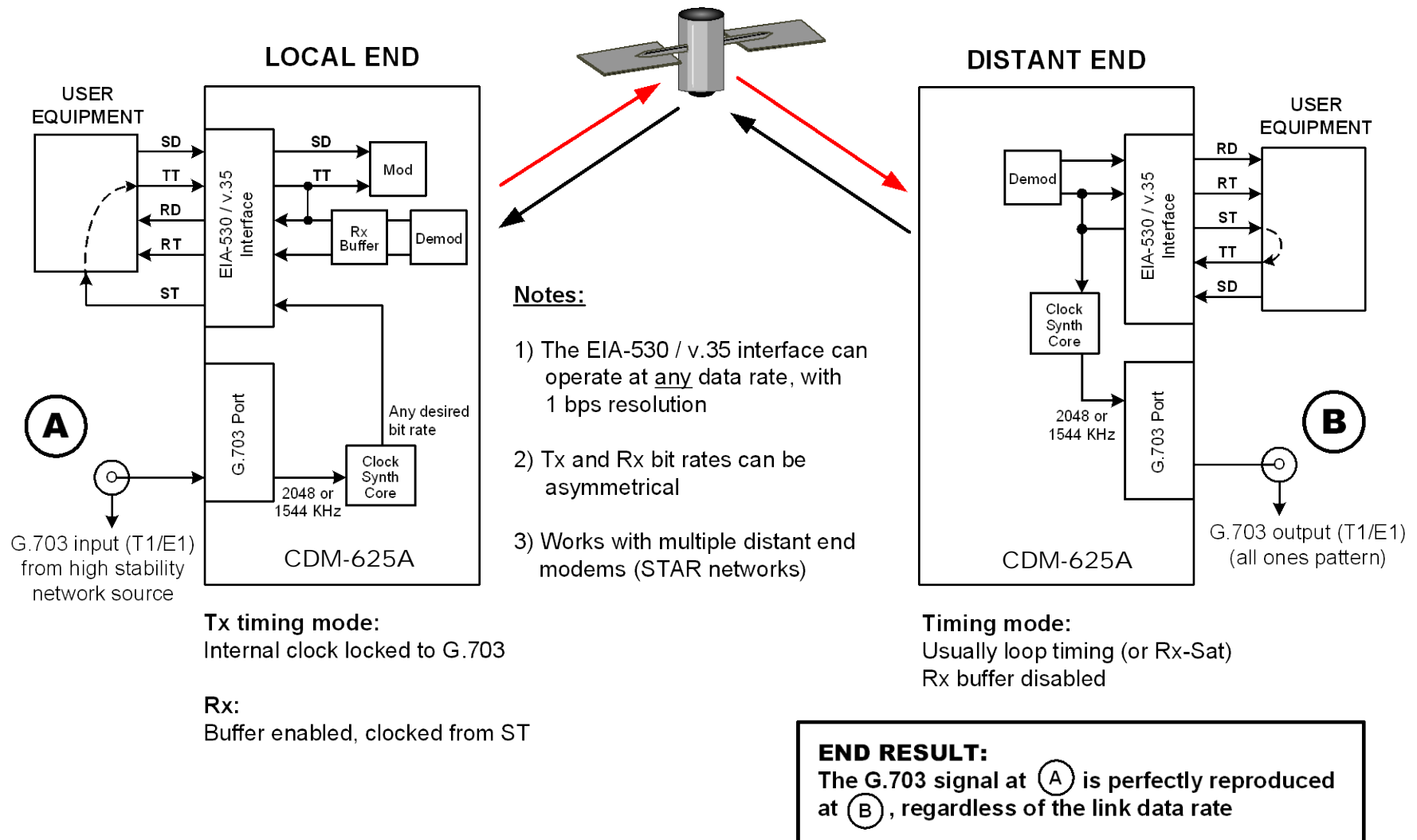

Figure E-7. G.703 Clock Extension Mode 1

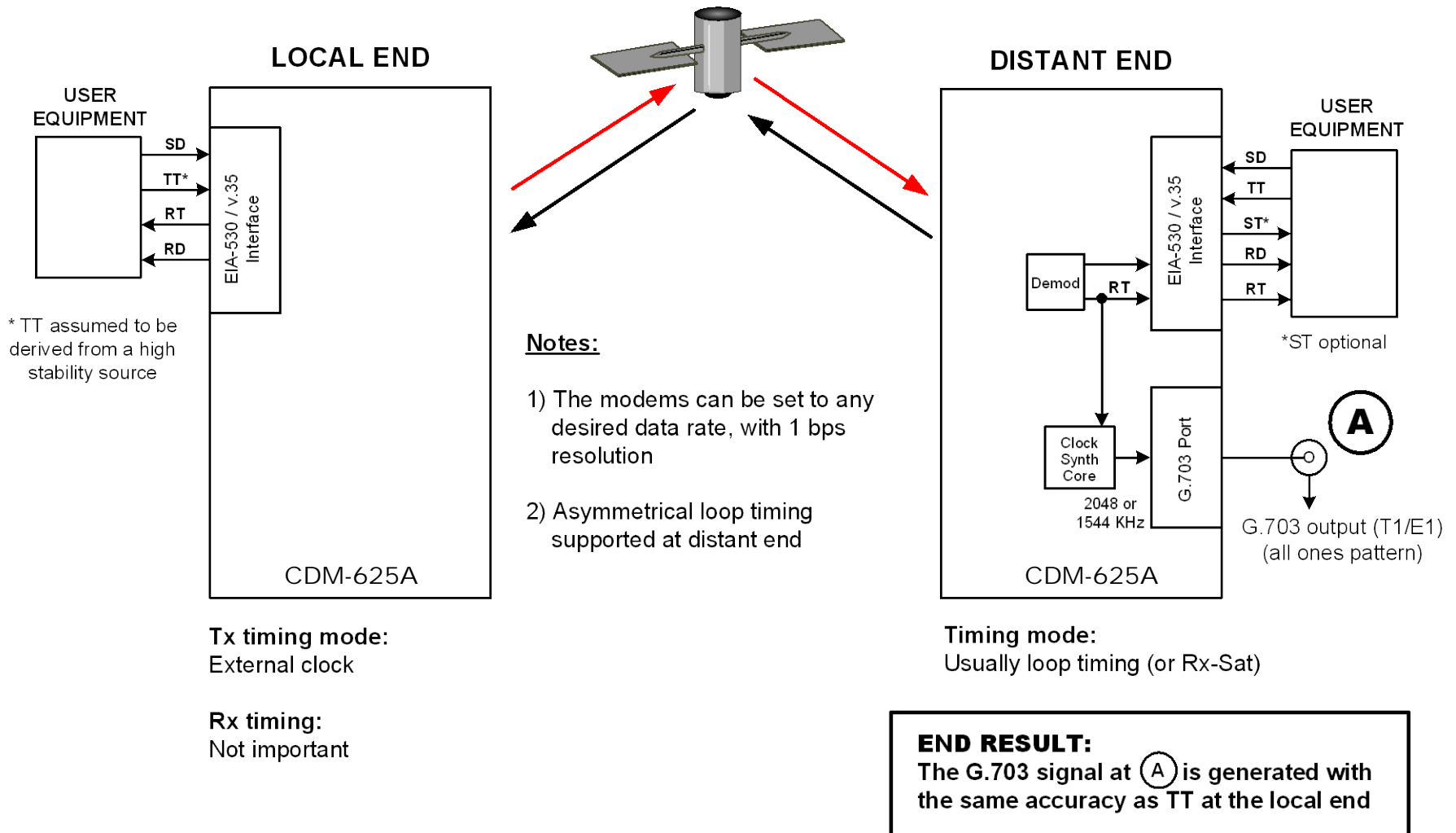

Figure E-8. G.703 Clock Extension Mode 2

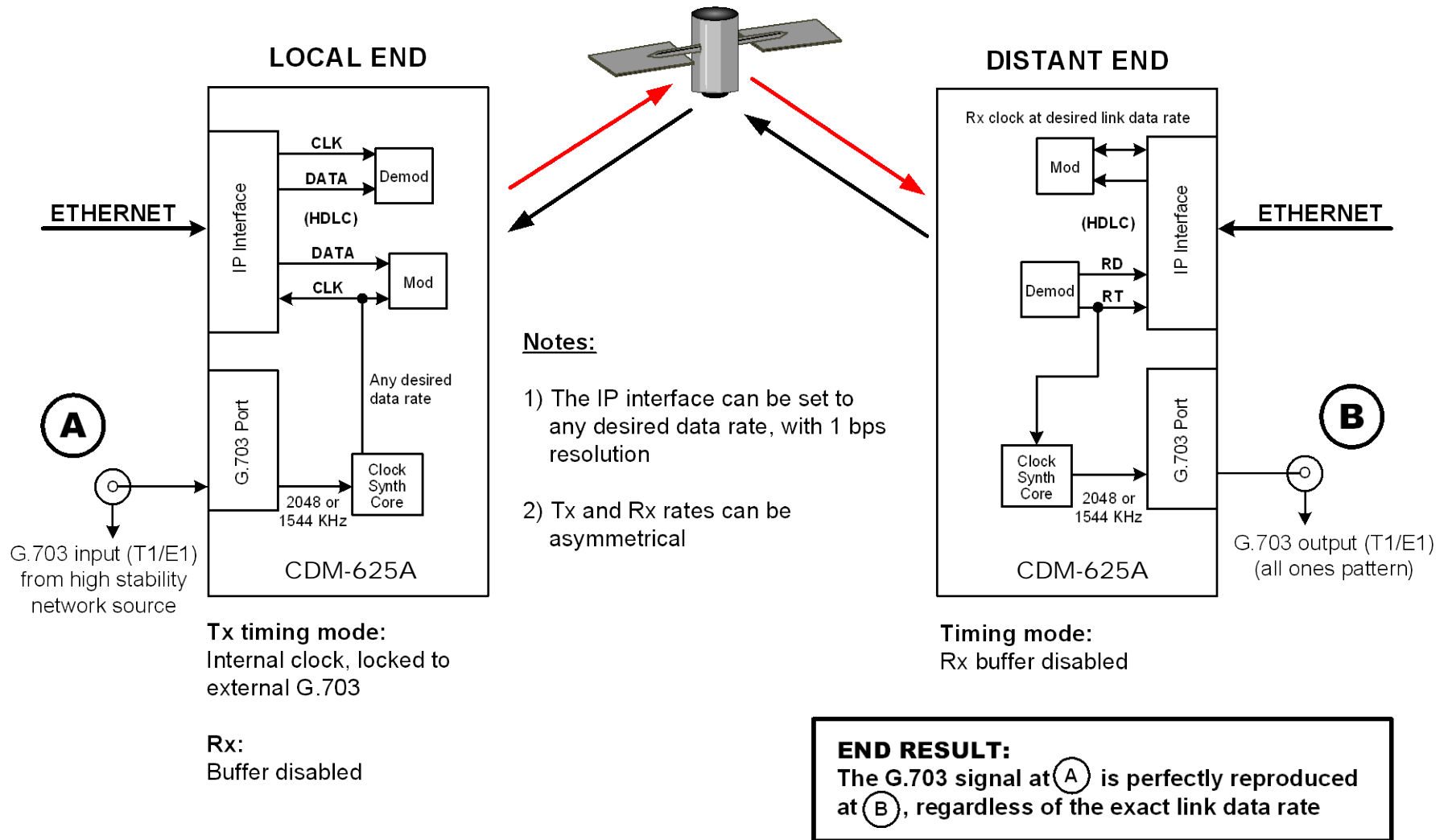

Figure E-9. G.703 Clock Extension Mode 3

E.12 Quad E1 Operation

Up to four complete or fractional E1 streams may be concatenated into a single Comtech proprietary satellite frame structure using the Quad E1 feature. The “Balanced G.703” and “Aux G.703” 9-pin D-sub female connectors on the CDM-625A rear panel each provide access to two ports. See **Sect. 3.2.2.2 G.703 Connectors** for pinout details.

Selected timeslots for each active port are “dropped” onto the transmit satellite frame in order of port number and drop channel number, with the reverse “insert” operation on the receive side. For each port, if $n=32$ is selected, then it is not assumed that the E1 into the modem contains framing. Data may be framed or unframed, and the modem will simply transmit the entire 2048 kbps stream on that port’s portion of the satellite frame; this is why timeslot selection is disabled for $n=32$. However, for any fractional value of “ n ”, the incoming E1 to that port must have TSO framing so that the selected timeslots to be dropped can be identified.

Recent improvements to Quad E1 operation allow the combining of asynchronous E1 streams. Before this, it was important for all ports to be synchronous to one another in order to operate without data loss – now, bit stuffing is performed on slower data streams to match them to faster ones. Satellite overhead is used to identify extra data on each port that was sent over the link. The extra data is then removed at the receiver, so that each port’s timing is maintained. As a result, it is important that the ports used and the number of timeslots for each port match at both ends of the link. The recommendation for G.703 requires that the actual bit rate be within ± 50 ppm of 2048 kbps.

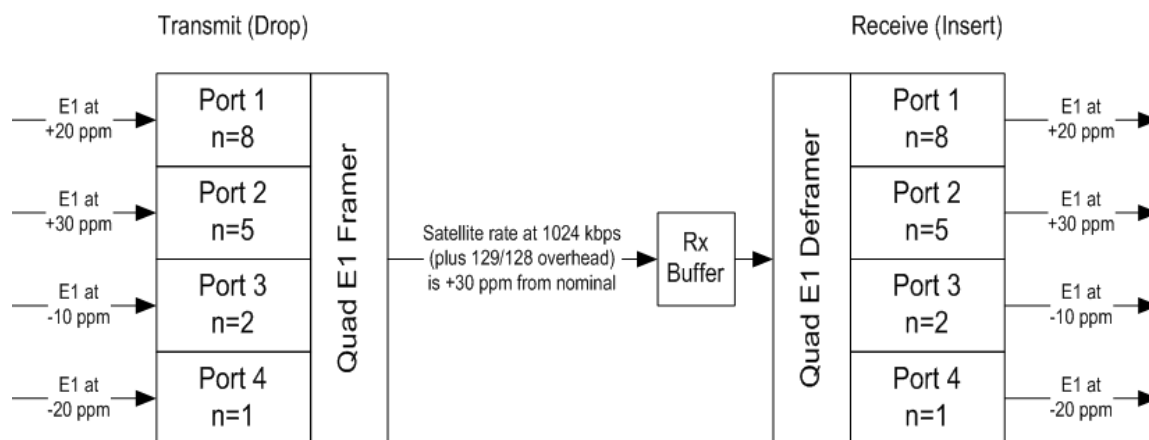

If asynchronous E1 streams are used at the transmit side of the link, it is important to keep the receive buffer set to “Rx Satellite”. The “Tx Terrestrial” setting should only be used if all E1 streams are synchronous to one another (no bit stuffing over the satellite frame) and the resulting E1 streams from the receiver need to be retimed to a local reference.

Appendix F. DOUBLETALK CARRIER-IN-CARRIER OPTION



WARNING! BEFORE ATTEMPTING TO COMMISSION A SATELLITE LINK USING CARRIER-IN-CARRIER, YOU **MUST** ENSURE THAT THE LINK IS ROBUST ENOUGH FOR NORMAL OPERATION. ONLY WHEN THIS HAS BEEN DONE – AND ALL SYSTEM ISSUES (E.G., ANTENNA-POINTING, CABLING, TERRESTRIAL INTERFERENCE, SATELLITE INTERFERENCE, ETC.) HAVE BEEN **RESOLVED** – SHOULD YOU ATTEMPT THE USE OF CARRIER-IN-CARRIER.

F.1 Overview

Space segment costs are typically the most significant operating expense for any satellite-based service, having a direct impact on the viability and profitability of the service. For a satellite transponder that has finite resources in terms of bandwidth and power, the leasing costs are determined by bandwidth and power used. Therefore, a satellite circuit should be designed for optimal utilization to use a similar share of transponder bandwidth and power.

The traditional approach to balancing a satellite circuit – once the satellite and earth station parameters are fixed – involves trade-off between modulation and coding. A lower order modulation requires less transponder power while using more bandwidth; conversely, higher order modulation reduces required bandwidth, albeit at a significant increase in power.

Comtech EF Data has added a new dimension to satellite communication optimization: DoubleTalk Carrier-in-Carrier.

F.1.1 What is DoubleTalk Carrier-in-Carrier?

The CDM-625A's DoubleTalk Carrier-in-Carrier (CnC) option uses a patented signal processing algorithm developed by Raytheon Applied Signal Technology that allows both the forward and reverse carriers of a full duplex link to share the same segment of transponder bandwidth, using patented "Adaptive Cancellation." Raytheon Applied Signal Technology uses the term DoubleTalk, and Comtech EF Data refers to it as DoubleTalk Carrier-in-Carrier (CnC)¹.

¹ DoubleTalk[®] is licensed from Raytheon Applied Signal Technology.
DoubleTalk[®] is a registered trademark of Raytheon Applied Signal Technology.
Carrier-in-Carrier[®] is a registered trademark of Comtech EF Data.

CnC was first introduced in Comtech EF Data's CDM-Qx Satellite Modem and, more recently, in the CLO-10 Link Optimizer. The implementation of DoubleTalk Carrier-in-Carrier in the CDM-625A has been further refined, and some of the limitations that existed in the CDM-Qx implementation have been overcome.

This innovative technology provides a significant improvement in bandwidth and power utilization, beyond what is possible with FEC and modulation alone, allowing users to achieve unprecedented savings. When combined with advanced modulation and FEC, it allows for multi-dimensional optimization:

- Reduced operating expense (OPEX) – e.g., Occupied Bandwidth & Transponder Power;
- Reduced capital expenditure (CAPEX) – e.g., Block Up Converter/High-Power Amplifier (BUC/HPA) size and/or antenna size;
- Increased throughput without using additional transponder resources;
- Increased link availability (margin) without using additional transponder resources;
- A combination of any of the above to meet different objectives.

Summary: When carriers share common bandwidth, up to 50% savings in transponder utilization is possible.

F.1.2 Application Requirements

The following conditions are necessary in order to operate DoubleTalk Carrier-in-Carrier:

- Link must be full duplex.
- A CDM-625A must be used at the end of the link where the cancellation needs to take place.
- The transponder is operated as Loopback. That is, each end of the link must be able to see a copy of its own signal in the return (downlink) path from the satellite. The looped back signal is then subtracted which leaves the signal from the distant end of the link. **DoubleTalk Carrier-in-Carrier cannot be used in spot beam systems.**
- The transponder needs to be “bent-pipe” – meaning no on-board processing, demodulation, regeneration can be employed. Demodulation/remodulation does not preserve the linear combination of the forward and return signals and the resulting reconstituted waveform prevents recovery of the original constituent signals.

Figure F-1 shows a simplified conceptual block diagram of CnC processing. The two ends of the link are denoted 'A' and 'B' and the uplink and downlink are shown.

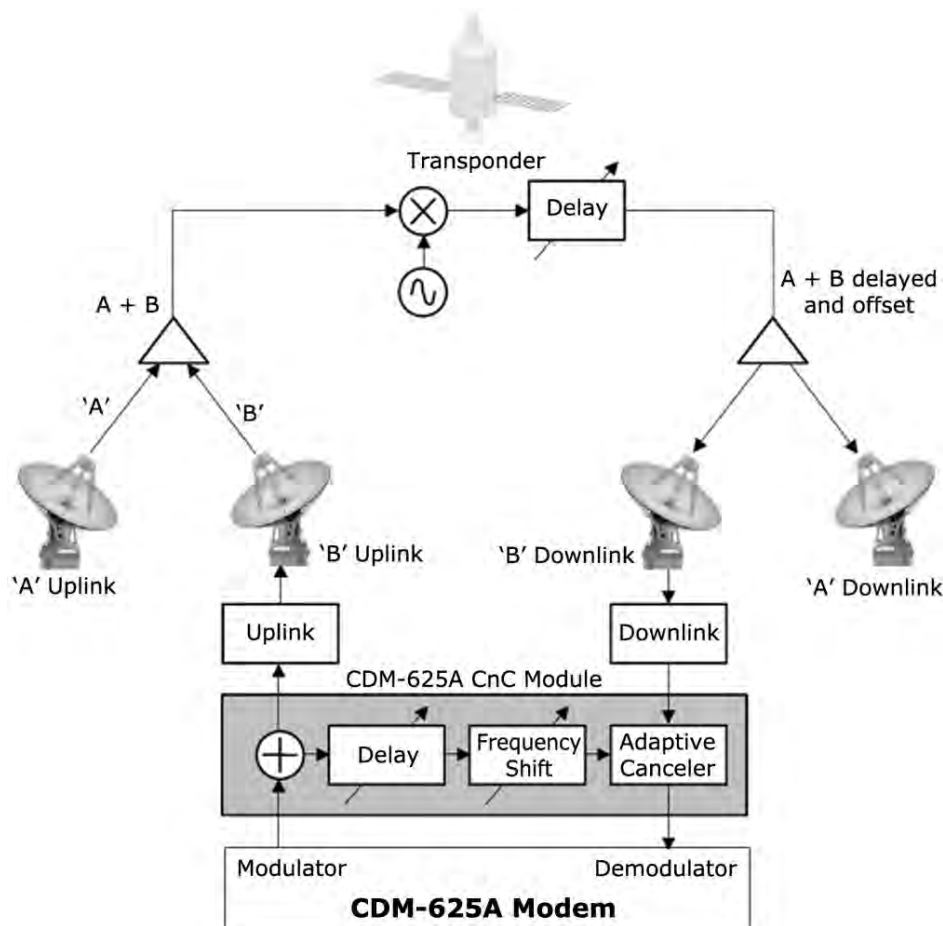

Figure F-1. Conceptual Block Diagram

This performance is achieved through advanced signal processing algorithms that provide superior cancellation while tracking and compensating for the following common link impairments:

- 1) **Time varying delay:** In addition to the static delays of the electronics and the round-trip delay associated with propagation to the satellite and back, there is a time-varying component due to movement of the satellite. CnC tracks and compensates for this variation.
- 2) **Frequency offset and drift:** Common sources are satellite Doppler shift, up and down converter frequency uncertainties, and other drift associated with the electronics in the CDM-625A itself. CnC tracks and compensates for this frequency offset and drift.
- 3) **Atmospheric effects:** Fading and scintillation can affect amplitude, phase, and spectral composition of the signal and the degree to which it correlates with the original signal. CnC tracks and compensates for these atmospheric related impairments.
- 4) **Link Asymmetries:** Various asymmetries in the forward and return link can produce differences in the relative power of the two received signal components. These can be both deterministic (static) or random (and time varying). An example of the former would be the differences resulting from antenna size/gain variations between the two ends of the link. An

example of the latter would be transient power differences due to different levels of atmospheric fading in the uplinks. CnC compensates for the asymmetries, up to a certain extent.

In a number of ways, CnC carriers behave similar to conventional carriers in satellite links. They are both exposed to adjacent carriers, cross-polarization and rain fade, and exhibit impairments when any of these become too great. In addition, CnC operates in an environment where:

- Carriers intentionally occupy the same spectral slot;
- Performance depends upon desired and co-located interfering carrier.

F.1.3 Operational Recommendations

The rules for CnC operation are summarized as follows:

- Both earth stations share the same footprint so each sees both carriers
- CnC carriers are operated in pairs
- One outbound with multiple return carriers is not allowed
- Asymmetric data rates are allowed (no restrictions)
- The ratio of power spectral density is normally less than 11 dB
- CnC operates with *modems* – **not** *modulators only* or *demodulators only*

In addition, to minimize ‘false’ acquisition, observe the following:

- Use of IESS-315 V.35 Scrambler is highly recommended
- Keep the search delay range as narrow as possible – once the modem has reported the search delay, narrow the search delay range to the nominal reported value ± 5 ms. For example, if the modem reported delay is 245 ms, narrow the search range to 240-250 ms
- Use external data source (e.g. Firebird) or internal BER tester when testing Carrier-in-Carrier performance
- To prevent self-locking in case the desired carrier is lost, it is recommended that the two carriers have some configuration difference – for example, use different settings for Spectrum Inversion.

F.2 System Functionality and Operational Considerations

Figure F-2 illustrates a conventional, full duplex satellite link where two carriers are placed in non-overlapping channels. **Figure F-3** shows the same link using the CDM-625A equipped with the DoubleTalk Carrier-in-Carrier option. Note that only 50% of the bandwidth is being used, as both carriers are now occupying the same bandwidth.

The transponder downlinks the composite signal containing both carriers on the same band to the CDM-625A which then translates the signal to near baseband where it can be filtered (decimated) and then processed as a complex envelope signal. The CDM-625A then suppresses the version of the near end carrier on the downlink side and then passes the desired carrier to the demodulator for normal processing.

To further illustrate, as shown in **Figure F-4**, without DoubleTalk Carrier-in-Carrier, the two carriers in a typical full duplex satellite link are adjacent to each other. With DoubleTalk Carrier-in-Carrier, only the composite signal is visible when observed on a spectrum analyzer. Carrier 1 and Carrier 2, shown here for reference only, are overlapping, thus sharing the same spectrum.

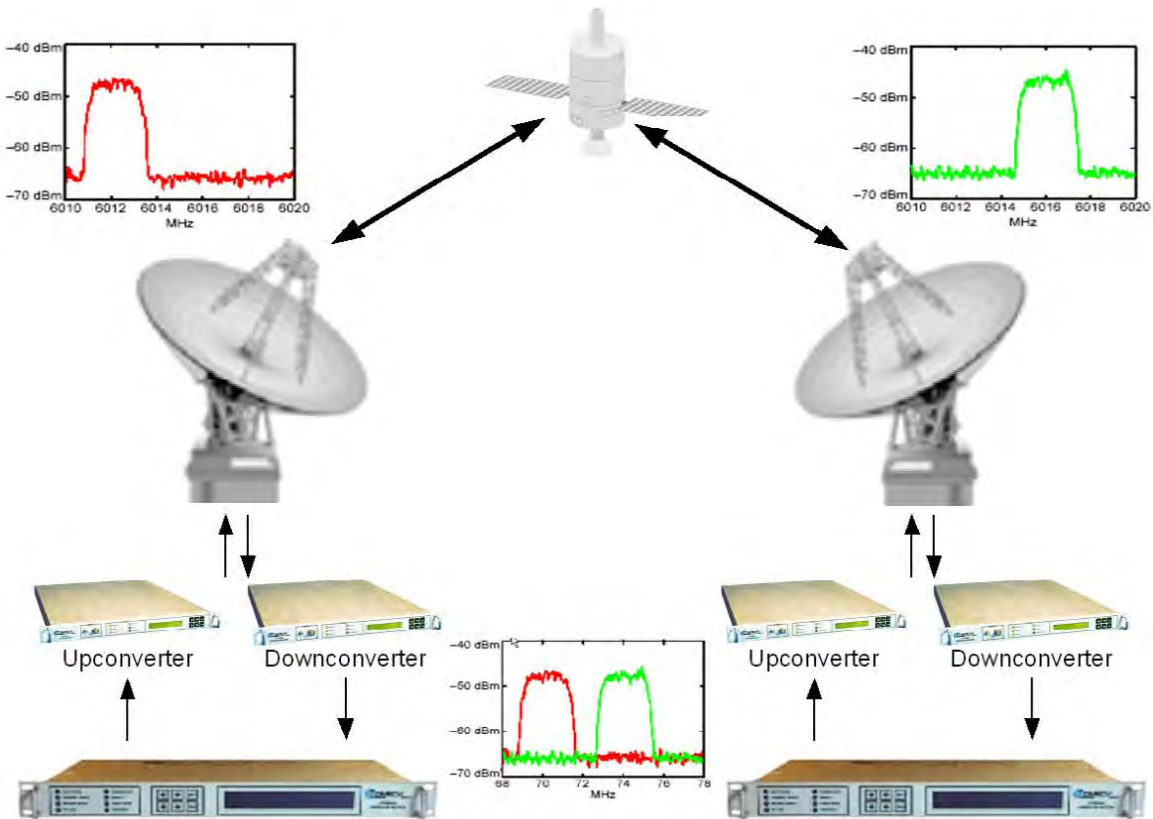

Figure F-2. Conventional FDMA Link

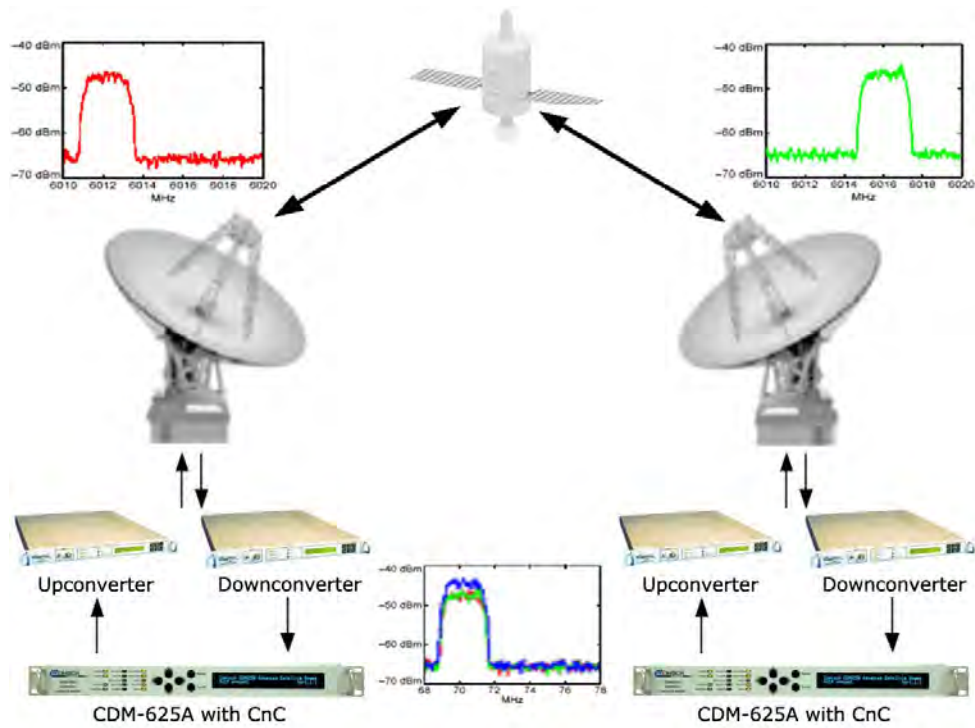

Figure F-3. Same Link Using CDM-625A and DoubleTalk Carrier-in-Carrier

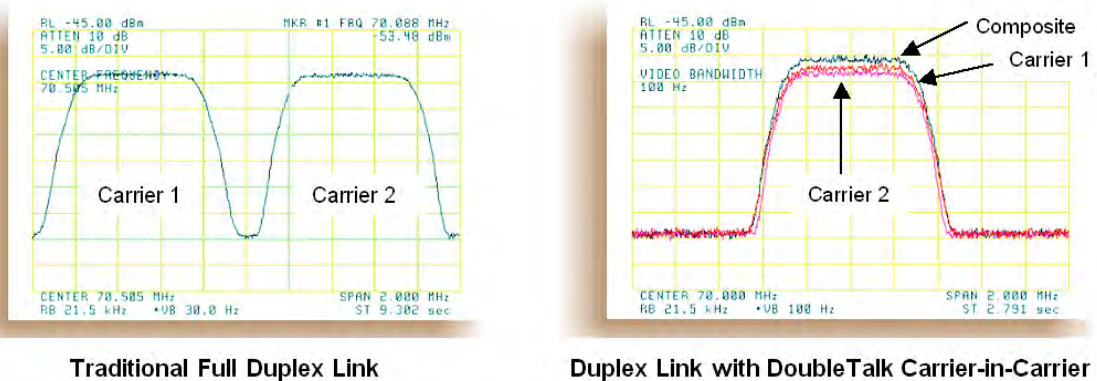

Figure F-4. Duplex Link Optimization

CnC operates on the near-zero signal before the demodulator, and is waveform agnostic. This means that no prior knowledge of the underlying modulation, FEC, or any other waveform specific parameter is required in order to perform the signal suppression operation. The only caveat to this is that the waveform must be *sufficiently random*.

Because acquiring the delay and frequency offset of the interfering carrier is fundamentally a correlation operation, anything deterministic in the interfering carrier (within the correlation window of the algorithm) will potentially produce false correlation peaks and result in incorrect delays and/or frequency. Normally, this is not a problem, since energy dispersal techniques are utilized in the vast majority of commercial and military modems. However, it is something that must be kept in mind when troubleshooting a system that utilizes the DoubleTalk Carrier-in-Carrier technique for signal suppression.

One possible way to mitigate false peaks is to narrow the correlation window. For example, if the delay is known to be around 240ms, set the minimum search delay to 230ms and the maximum search delay to 250ms.

As all advances in modem technologies – including advanced modulation and FEC techniques – approach their theoretical limits of power and bandwidth efficiencies, DoubleTalk Carrier-in-Carrier allows satellite users to achieve spectral efficiencies (bps/Hz) that cannot be achieved with modulation and FEC alone. **Table F-1** illustrates how DoubleTalk Carrier-in-Carrier, when used with 16-QAM, approaches the bandwidth efficiency of 256-QAM (8bps/Hz).

Table F-1. Spectral Efficiency using DoubleTalk Carrier-in-Carrier

Modulation and Code Rate	Spectral Efficiency (bps/Hz)	
	TraditionalSCPC	Carrier-in-Carrier
BPSK 1/2	0.50	1.00
QPSK 1/2	1.00	2.00
QPSK 2/3	1.33	2.67
QPSK 3/4	1.50	3.00
QPSK 7/8	1.75	3.50
8-QAM 2/3	2.00	4.00
8-QAM 3/4	2.25	4.50
8-QAM 7/8	2.63	5.25
16-QAM 3/4	3.00	6.00
16-QAM 7/8	3.50	7.00

As shown here, DoubleTalk Carrier-in-Carrier allows equivalent spectral efficiency using a lower order modulation and/or FEC Code Rate; CAPEX is therefore reduced by allowing the use of a smaller BUC/HPA and/or antenna. And, as DoubleTalk Carrier-in-Carrier can be used to save transponder bandwidth and/or transponder power, it can be successfully deployed in bandwidth-limited as well as power-limited scenarios.

F.2.1 DoubleTalk Carrier-in-Carrier Cancellation Process

The state-of-the-art signal processing technology employed via DoubleTalk Carrier-in-Carrier continually estimates and tracks all parametric differences between the local uplink signal and its image within the downlink. Through advanced adaptive filtering and phase locked loop implementations, it dynamically compensates for these differences by appropriately adjusting the delay, frequency, phase and amplitude of the sampled uplink signal, resulting in excellent cancellation performance.

When a full duplex satellite connection is established between two sites, separate satellite channels are allocated for each direction. If both directions transmitted on the same channel, each side would normally find it impossible to extract the desired signal from the aggregate due to interference originating from its local modulator. However since this interference is produced

locally, it is possible to estimate and remove its influence prior to demodulation of the data transmitted from the remote location.

For the DoubleTalk Carrier-in-Carrier cancellation, it is necessary to provide each demodulator with a copy of its local modulator's output.

Referring to Figure F-5: Modem 1 and Modem 2 transmit signals S_1 and S_2 respectively. The satellite receives, translates, and retransmits the composite signal. The downlink signals S_1^* and S_2^* , received at Modem 1 and Modem 2 differ from the transmit signals primarily in terms of phase, frequency, and delay offsets.

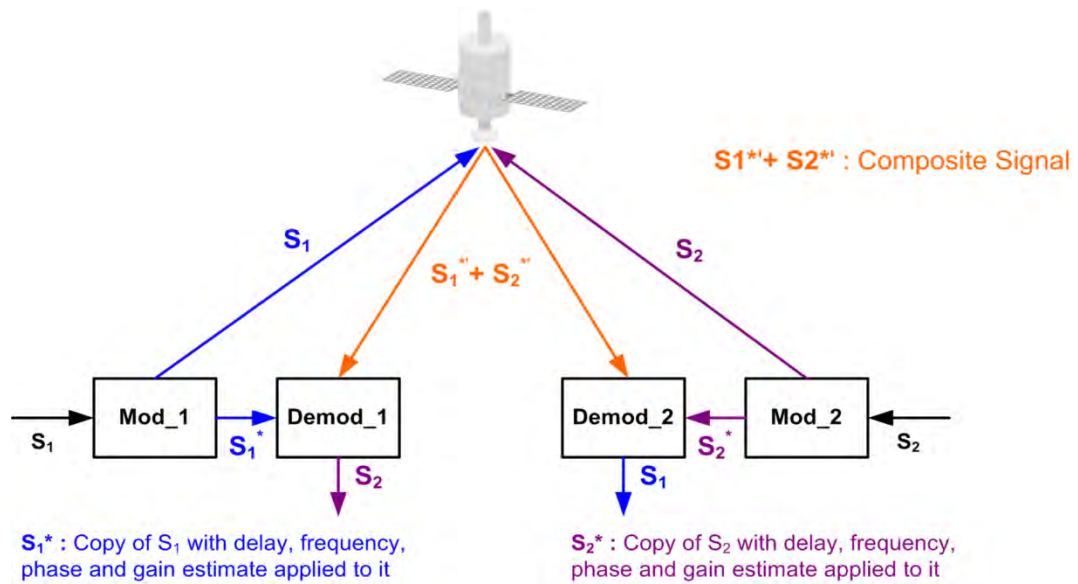

Figure F-5. DoubleTalk Carrier-in-Carrier Signals

Referring to Figure F-6: For round trip delay estimation, a search algorithm is utilized that correlates the received satellite signal to a stored copy of the local modulator's transmitted signal. The interference cancellation algorithm uses the composite signal and the local copy of S_1 to estimate the necessary parameters of scaling (complex gain/phase), delay offset and frequency offset. The algorithm continuously tracks changes in these parameters as they are generally time-varying in a satellite link.

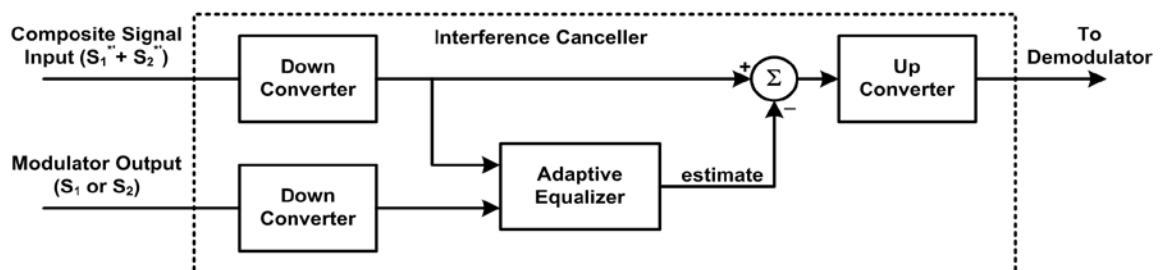

Figure F-6. Carrier-in-Carrier Signal Processing Block Diagram

The resulting estimate of the unwanted interfering signal is then subtracted from the composite signal. In practical applications, the estimate of the unwanted signal can be extremely accurate.

Unwanted interfering signal suppression of 30 dB or more has been achieved in commercial products with minimal degradation of the demodulator performance.

F.2.2 Margin Requirements

Typical interfering signal cancellation is 28 to 35 dB (depending on the product). The residual interfering signal appears as noise causing a slight degradation of the E_b/N_o . To compensate for the residual noise, a small amount of additional link margin is required to maintain the BER. Margin requirements depend on the product, modulation and power ratios:

For the CDM-625A, the additional margin requirements are as follows:

Modulation	Nominal Margin*
BPSK	0.3 dB
QPSK/OQPSK	0.3 dB
8-PSK	0.5 dB
8-QAM	0.4 dB
16-QAM	0.6 dB

* Equal power and equal symbol rate for the interfering carrier and the desired carrier, i.e., 0 dB PSD ratio. Measured at IF with AWGN, +10 dBc Adjacent Carriers, 1.3 spacing.

F.2.3 Carrier-in-Carrier Latency

Carrier-in-Carrier has no measurable impact on circuit latency.

F.2.4 Carrier-in-Carrier and Adaptive Coding and Modulation

Carrier-in-Carrier is fully compatible with VersaFEC Adaptive Coding and Modulation (ACM) mode of operation in the CDM-625A.

Carrier-in-Carrier combined with VersaFEC ACM can provide 100-200% increase in average throughput.

F.2.5 Carrier-in-Carrier Link Design

Carrier-in-Carrier link design involves finding the FEC and modulation combination that provides optimal bandwidth utilization. Just like conventional link design, it is an iterative process that involves trying different FEC and modulation combinations with Carrier-in-Carrier until an optimal combination is found.

For optimal Carrier-in-Carrier performance, it is recommended that the two carriers have similar symbol rate and power. This can be achieved by selecting appropriate ModCods as shown in following sections.

F.2.5.1 Symmetric Data Rate Link

Consider the following example:

Satellite & Transponder	Galaxy 18 @ 123° W, 13K/13K
Earth Station 1	Phoenix, AZ – 4.6 m
Earth Station 2	Phoenix, AZ – 2.4 m
Data Rate	512 kbps / 512 kbps

The traditional link was based on QPSK TPC 3/4 and required 0.96 MHz of leased BW. The LST² summary for the traditional link is as follows:

Link Analysis Description:			
MultiCarrier Txpdr Lease	Link 1	Link 2	
Number of links: <input type="text" value="2"/>			
Modulation	QPSK	QPSK	
Information Rate	512.0	512.0	kbps
FEC Code Rate	.7500	.7500	
R-S Code Rate	N/A	N/A	
Clear Sky Eb/No Available	9.3	8.7	dB
Number of Assigned Carriers	1	1	
Transmit ES Code	4_6M	2_4M	
Transmit ES Size	4.6	2.4	m
Receive ES Code	2_4M	4_6M	
Receive ES Size	2.4	4.6	m
Receive ES G/T	24.5	29.0	dB/K

Total Leased Resource Usage:			
LST calculated		Total BW allocated	9557 MHz
(MultiCarrier Txpdr Lease)		Total BW PEB	8208 MHz
Total EIRP utilized	20.1 dBW	Total BW utilized	9557 MHz
Total EIRP available	20.9 dBW	Total BW available	1.0000 MHz
Margin (available-utilized)	.9 dB	Margin (available-utilized)	.0443 MHz

Allocated BW = 0.9557 MHz
PEB = 0.8208 MHz
Leased BW = 0.9557 MHz

Carrier-in-Carrier link design involved trying different Modulation & FEC Code Rates to find the optimal combination:

- 8-QAM, LDPC 2/3 with Carrier-in-Carrier
- QPSK, LDPC 3/4 with Carrier-in-Carrier
- QPSK, LDPC 2/3 with Carrier-in-Carrier
- QPSK, LDPC 1/2 with Carrier-in-Carrier

² LST is Intelsat’s Lease Transmission Plan Program.

Link parameters and LST summary for QPSK, LDPC 2/3 with Carrier-in-Carrier is as follows:

Digital Carrier Definition

Select From Available Products & Modems...

Carrier Type: Lease
Performance (BER):
FEC Code Rate: .6670
R-S Code Rate: n= N/A, k= N/A
Overhead: .0 %
Modulation: QPSK
Eb/No Threshold: 3.4 dB
C/N Threshold: 4.7 dB
U/L Carrier Center Freq.: 14242.00000 MHz
Car/Link: 1, Act. Fact.: 100 %

Information Rate: 512.0 kbits/s
Alloc. BW: a= .40, .5373 MHz
Noise BW: .3838 MHz
Min Uplink Rain Margin:
Min Dnlink Degrad. Margin:
Total Availability: 99.970 % yr

Transmit ES Code: 4_6M
Receive ES Code: 2_4M

Buttons: Return, Accept, Copy, Cancel, Link: 1, 2, -User Specified, -LST Calculated

Includes IF-RF Margin and CnC Margin

Link Analysis Description:

	Link 1	Link 2	
MultiCarrier Txpdr Lease			
Number of links	2		
Modulation	QPSK	QPSK	
Information Rate	512.0	512.0	kbit/s
FEC Code Rate	.6670	.6670	
R-S Code Rate	N/A	N/A	
Clear Sky Eb/No Available	7.9	7.3	dB
Number of Assigned Carriers	1	1	
Transmit ES Code	4_6M	2_4M	
Transmit ES Size	4.6	2.4	m
Receive ES Code	2_4M	4_6M	
Receive ES Size	2.4	4.6	m
Receive ES G/T	24.5	29.0	dB/K

Total Leased Resource Usage:

LST calculated		Total BW allocated	1.0747 MHz
(MultiCarrier Txpdr Lease)		Total BW PEB	.5777 MHz
Total EIRP utilized	18.6 dBW	Total BW utilized	1.0747 MHz
Total EIRP available	21.4 dBW	Total BW available	1.1000 MHz
Margin (available-utilized)	2.8 dB	Margin (available-utilized)	.0253 MHz

CnC Allocated BW = 1.0747 / 2 = 0.53735 MHz
CnC PEB = 0.5777 MHz
CnC Leased BW = 0.5777 MHz

The link budget summary for the different ModCod combinations is as follows:

S. No.	Modulation & FEC	Allocated BW (MHz)	PEB (MHz)	Leased BW (MHz)	Savings Compared to Original	PSD Ratio (dB)
1	8-QAM, LDPC 2/3	0.3584	1.1468	1.1468	-20%	2.1
2	QPSK, LDPC 3/4	0.47785	0.6734	0.6734	30%	2.1
3	QPSK, LDPC 2/3	0.53735	0.5777	0.5777	40%	2.1
4	QPSK, LDPC 1/2	0.7168	0.5184	0.7168	25%	2.1

Based on this analysis, QPSK, LDPC 2/3 with Carrier-in-Carrier provides the maximum savings of 40%. In addition to 40% reduction in Leased Bandwidth, using Carrier-in-Carrier also reduced the required HPA Power by almost 40%:

HPA Power	Traditional Link (QPSK, TPC 3/4)	CnC Link (QPSK, LDPC 2/3)	HPA Power Reduction
HPA @ 4.6 m	0.7 W	0.5 W	40%
HPA @ 2.4 m	1.5 W	1.1 W	36%

F.2.5.2 Asymmetric Data Rate Link

As occupied (or allocated) bandwidth of a Carrier-in-Carrier circuit is dictated by the larger of the two carriers, it is strongly recommended that the smaller carrier be spread as much as possible using a lower order modulation and/or FEC, while meeting the PSD ratio spec. Spreading the smaller carrier using a lower order modulation has multiple benefits:

- Lower order modulation is always more robust;
- Lower order modulation uses less transponder power – this reduces total transponder, and increases available link margin;
- Lower order modulation uses less transmit power on the ground – this can significantly reduce the BUC/SSPA size by not only reducing the transmit EIRP, but also reducing the BUC/SSPA backoff

Consider the following example:

Satellite & Transponder	IS-901 @ 342° W, 22/22 (EH/EH)
Earth Station 1	Africa – 4.5 m
Earth Station 2	Africa – 3.0 m
Data Rate	3000 Mbps / 1000 Mbps

While the traditional link was based on QPSK, TPC 3/4 and required 3.9 MHz of leased bandwidth, the Carrier-in-Carrier link was based on QPSK, LDPC 3/4 and QPSK, LDPC 1/2 and required 2.8 MHz of leased bandwidth.

The savings summary is as follows:

Item	Original Link			With Carrier-in-Carrier and LDPC			Savings
	Hub to Remote	Remote to Hub	Total	Hub to Remote	Remote to Hub	Total	
Data Rate (kbps)	3000	1000		3000	1000		
Modulation	QPSK	QPSK		QPSK	QPSK		
FEC	TPC 3/4	TPC 3/4		LDPC 3/4	LDPC 1/2		
Occupied BW (MHz)	2.8	0.9	3.7	2.8	1.4	2.8	
Power Eq. BW (MHz)	3.3	0.6	3.9	2.5	0.3	2.8	
Leased BW (MHz)			3.9			2.8	27.5%
Hub HPA (W)	26.0			20.3			22%
Remote HPA (W)	10.6			6.4			40%

If this link was designed using QPSK, LDPC 3/4 in both directions, it would have required:

Occupied BW	2.8 MHz	
Power Eq. BW	3.0 MHz	7.2% increase in Power Eq. BW
Leased BW	3.0 MHz	7.2% increase in Leased BW
Hub HPA	20.3 W	
Remote HPA	8.3 W	30% increase in Remote power

F.2.5.3 Power Limited Links

Carrier-in-Carrier can provide substantial savings even when the original link is power limited. Spreading the carrier by using a lower modulation and/or FEC along with latest FEC such as VersaFEC can substantially reduce the total power, which can then be traded with bandwidth using Carrier-in-Carrier. The concept is illustrated with the following examples:

The conventional link is using 8-PSK, TPC 3/4:

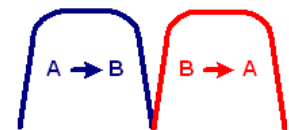

Switching to VersaFEC and using a lower order modulation – e.g., QPSK, VersaFEC 0.803 increases the total occupied bandwidth, while reducing the total power equivalent bandwidth:

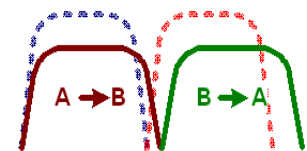

Now using DoubleTalk Carrier-in-Carrier, the second QPSK, VersaFEC 0.803 carrier can be moved over the first carrier – thereby significantly reducing the total occupied bandwidth and total power equivalent bandwidth when compared to the original side-by-side 8PSK, TPC 3/4 carriers:



To continue, consider this example:

Satellite & Transponder	IS-901 @ 342° W, 22/22 (EH/EH)
Earth Station 1	Africa – 9.2 m
Earth Station 2	Africa – 4.5 m
Data Rate	2.048 Mbps / 2.048 Mbps

Whereas the original link used 8-PSK TPC 3/4, the Carrier-in-Carrier link used QPSK VersaFEC 0.803. The savings summary is as follows:

Item	Original Link			With Carrier-in-Carrier and VersaFEC			Savings
	Hub to Remote	Remote to Hub	Total	Hub to Remote	Remote to Hub	Total	
Data Rate (kbps)	2048	2048		2048	2048		
Modulation	8-PSK	8-PSK		QPSK	QPSK		
FEC	TPC 3/4	TPC 3/4		0.803	0.803		
Occupied BW (MHZ)	1.3	1.3	2.6	1.8	1.8	1.8	
Power Eq. BW (MHz)	2.2	1.0	3.2	1.1	0.5	1.6	
Leased BW (MHz)			3.2			1.8	44%
Hub HPA (W)	5.0			2.0			60%
Remote HPA (W)	11.6			4.7			60%
Note: 1 dB HPA BO for QPSK, 2 dB HPA BO for 8-PSK, 1 dB Feed Loss.							

Using Carrier-in-Carrier and VersaFEC reduced the leased bandwidth by almost 44% and HPA power by 60%.

F.2.6 Carrier-in-Carrier Commissioning and Deployment

Prior to commissioning a Carrier-in-Carrier link, it is critical that the link is fully tested in non Carrier-in-Carrier mode and all system issues including external interference, antenna pointing, cabling, SSPA backoff are resolved., You should attempt to turn Carrier-in-Carrier on only after the link is robust.

Comtech EF Data recommends that you do these steps for CnC commissioning and deployment:

Step	Task
1	<p>Turn ON the carrier at Site 'A'. Carrier from Site 'B' is OFF. CnC function is OFF at both sites.</p> <ul style="list-style-type: none"> Using a spectrum analyzer, measure Co+No/No at the input to the modem at Site 'A'. Using a spectrum analyzer, measure Co+No/No at the input to the modem at Site 'B'. Measure/record Eb/No at Site 'B'. Make sure there is sufficient margin to account for CnC. Measure/record Receive Signal Level (RSL) at Site 'B'.
2	<p>Turn OFF the carrier at Site 'A'. Turn ON the carrier at Site 'B'. CnC function is OFF at both sites.</p> <ul style="list-style-type: none"> Using a spectrum analyzer, measure Co+No/No at the input to the modem at Site 'A'. Using a spectrum analyzer, measure Co+No/No at the input to the modem at Site 'B'. Measure/record Eb/No at Site 'A'. Make sure there is sufficient margin to account for CnC. Measure/record RSL at Site 'B'.
3	<p>Using Co+No/No readings calculate PSD ratio at Site 'A' and Site 'B'. If it is not within specification, make necessary adjustments to bring it within specification and repeat measurements in Steps (1) and (2).</p> <ul style="list-style-type: none"> Also verify that the RSL is within spec.
4	<p>Now without changing the transmit power levels, turn ON both the carriers (on the same frequency) and turn CnC ON.</p> <ul style="list-style-type: none"> Measure/record Eb/No at Sites 'A' and 'B'. Measure/record RSL at Sites 'A' and 'B'. Now compare Eb/No in presence of 2 over lapping carriers with CnC with Eb/No when only 1 carrier was ON. Eb/No variation should be within spec for that modulation, FEC and PSD ratio.
5	<p>The test can be repeated for different PSD ratio and Eb/No.</p>

F.2.7 Validate Carrier-in-Carrier Performance

You may easily validate Carrier-in-Carrier performance by verifying that E_b/N_0 degradation due to Carrier-in-Carrier is within published specification for the observed Power Spectral Density Ratio.

Comtech EF Data recommends that you do these steps to validate CnC performance:

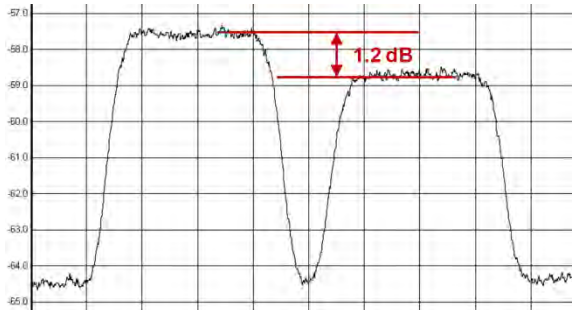
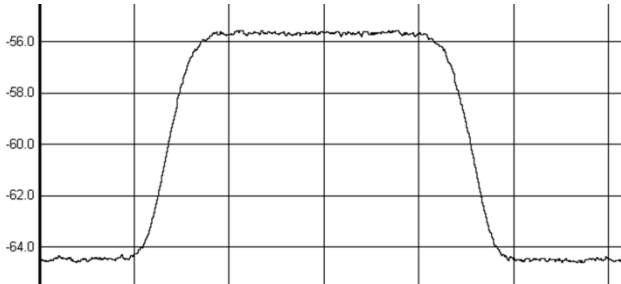
Step	Task
1	<p>Setup a conventional side-by-side link of the desired E_b/N_0:</p> <ul style="list-style-type: none"> Carrier-in-Carrier should be OFF. Record the E_b/N_0 as displayed by the Modems. Observe the 2 carriers on a spectrum analyzer and record the PSD ratio. <p>Example Link:</p> <ul style="list-style-type: none"> Full duplex 512 kbps, QPSK, LDPC 2/3 circuit between 4.6 m and 2.4 m antennas Recorded $E_b/N_0 = 2.6$ dB (at both modems) PSD Ratio = 1.2 dB (measured at larger Antenna) 
2	<p>Now relocate one of the carriers on top of the other carrier:</p> <ul style="list-style-type: none"> Enable Carrier-in-Carrier. Record the E_b/N_0 as displayed by the Modems.
3	<p>Calculate change in E_b/N_0 and verify against specification.</p> <p>Example Link:</p> <ul style="list-style-type: none"> Recorded $E_b/N_0 = 2.4$ dB Change in $E_b/N_0 = 0.2$ dB E_b/N_0 Degradation (Spec.) at 1.2 dB PSD = 0.3 dB Modem performance is within spec 

F.3 Operational References

F.3.1 Calculate Carrier-in-Carrier Link Budget

Comtech EF Data recommends that you do these steps to calculate the link budget for a CnC Link:

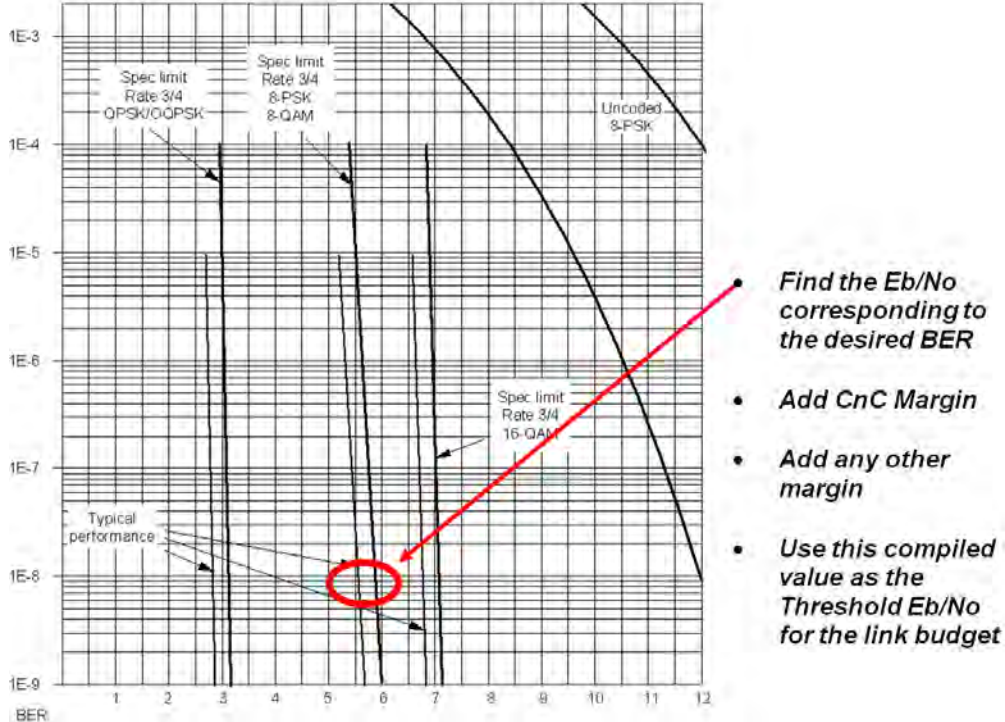
Step	Task
1	<p>Calculate the link budget for both carriers in the duplex link, with required CnC margin:</p>  <ul style="list-style-type: none"> • Find the E_b/N_0 corresponding to the desired BER • Add CnC Margin • Add any other margin • Use this compiled value as the Threshold E_b/N_0 for the link budget
2	Verify that the PDS ration is within spec for the CDM-625A.
3	<p>Calculate the Allocated Bandwidth (BW) and Power Equivalent Bandwidth (PEB) for the duplex link:</p> <ul style="list-style-type: none"> • $BW_{\text{Duplex Link}} = \text{Greater of } (BW_{\text{Carrier 1}}, BW_{\text{Carrier 2}})$ • $PEB_{\text{Duplex Link}} = PEB_{\text{Carrier 1}} + PEB_{\text{Carrier 2}}$ • $\text{Leased } BW_{\text{Duplex Link}} = \text{Greater of } (BW_{\text{Duplex Link}}, PEB_{\text{Duplex Link}})$
4	For an optimal link, the Leased Bandwidth and the Power Equivalent Bandwidth should be equal / nearly equal.
5	Repeat the link budget process by selecting different Modulation and FEC, until the BW and PEB is nearly balanced.

F.3.2 Methods to Estimate PSD Ratio

F.3.2.1 Use Downlink EIRP and Symbol Rate

Use Downlink EIRP and Symbol Rate to estimate the PSD Ratio from a link budget:

$$\text{PSD} = \text{Downlink EIRP} - 10 * \text{Log} (\text{Symbol Rate})$$

PSD Ratio Example:

Carrier	Downlink EIRP	Symbol Rate	Power Spectral Density
A to B	27 dBW	500 ksps	-29.99 dBW/Hz
B to A	24 dBW	375 ksps	-31.74 dBW/Hz

$$\text{PSD Ratio (@ A)} = -29.99 - (-31.74) = 1.75 \text{ dB}$$

$$\text{PSD Ratio (@ B)} = -31.74 - (-29.99) = -1.75 \text{ dB}$$

F.3.2.2 Use LST

Carrier Information	Link 1	Link 2	
Carrier Type	IPL	IPL	
Performance			BER
Modulation	8-Phase	8-Phase	
Eb/No Threshold	5.6	5.6	dB
C/N Threshold	8.6	8.6	dB
Center Frequency	6014.0	6014.0	MHz
Information Rate (IR)	4096.0	4096.0	kbit/s
Overhead (OH)	.0	.0	kbit/s
Data Rate (IR + OH)	4096.0	4096.0	kbit/s
FEC Code Rate	.6667	.6667	
R-S Code Rate	N/A	N/A	
Transmission Rate	6143.7	6143.7	kbit/s
Bandwidths and Margins			
Filter Rolloff Factor	.40	.40	
Allocated Bandwidth	2.8671	2.8671	MHz
Noise Bandwidth	2.0479	2.0479	MHz
Number of Assigned Carriers Per Link	1	1	

PSD Link 2
 $15.8 - 10 * \text{Log} (2.0479 * 1000000) = -47.3 \text{ dBW/Hz}$

PSD Ratio
 $\pm 1.0 \text{ dB}$

PSD Link 1
 $16.8 - 10 * \text{Log} (2.0479 * 1000000) = -46.3 \text{ dBW/Hz}$

Per Carrier UL & DL eirp (Clr-Sky)	Link 1	Link 2	
Transmit ES elevation angle	70.4	54.5	deg
Uplink EIRP per carrier	58.7	57.0	dBW
Pathloss at uplink frequency	199.3	199.5	dB
Gain of 1 m2 antenna	37.1	37.1	dB
Per carrier FD @SC	-103.5	-105.4	dBW/m2
SC pattern advantage @ES	1.8	2.8	dB
Per carrier BE FD arriving @ SC	-101.7	-102.7	dBW/m2
Transponder BE SFD	-79.0	-79.0	dBW/m2
Per carrier input back-off	-22.7	-23.7	dB
Per carrier output back-off	-20.2	-21.2	dB
Transponder BE saturation EIRP	37.0	37.0	dBW
Downlink BE EIRP	16.8	15.8	dBW

F.3.2.3 Use Satmaster

Carrier A to B

Space Segment Utilization	Value	Units
Overall link availability	99.800	%
Information rate (inc overhead)	10.2400	Mbps
Transmit rate	13.6533	Mbps
Symbol rate	3.4133	Mbaud
Occupied bandwidth	4.2667	MHz
Noise bandwidth	66.30	dB-Hz
Minimum allocated bandwidth required	4.2667	MHz
Allocated transponder bandwidth	4.2667	MHz
Percentage transponder bandwidth used	11.85	%
Used transponder power	22.57	dBW
Percentage transponder power used	7.20	%

Carrier B to A

Space Segment Utilization	Value	Units
Overall link availability	99.800	%
Information rate (inc overhead)	10.2400	Mbps
Transmit rate	13.6533	Mbps
Symbol rate	3.4133	Mbaud
Occupied bandwidth	4.2667	MHz
Noise bandwidth	66.30	dB-Hz
Minimum allocated bandwidth required	4.2667	MHz
Allocated transponder bandwidth	4.2667	MHz
Percentage transponder bandwidth used	11.85	%
Used transponder power	24.52	dBW
Percentage transponder power used	8.96	%

PSD Carrier A to B
 $= 22.57 - 10 * \text{Log}(3.4133 \times 10^6)$
 $= -42.76 \text{ dBW/Hz}$

PSD Carrier B to A
 $= -40.81 \text{ dBW/Hz}$

PSD Ratio
 $\pm 1.95 \text{ dB}$

CnC Ratio
 $\pm 1.95 \text{ dB}$

F.3.2.4 Use a Spectrum Analyzer

You may use a Spectrum Analyzer capable of integrating the signal power in a given bandwidth to estimate PSD Ratio or CnC Ratio:

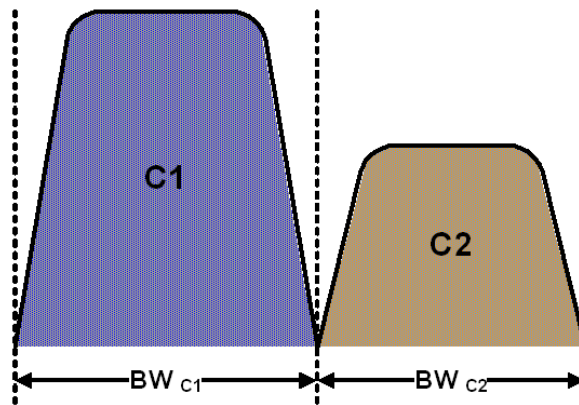

CnC Ratio (in dB) = Power_{C1} (in dBm) – Power_{C2} (in dBm)

PSD Ratio (in dB) = (Power_{C1} – 10 log BW_{C1} (in Hz)) – (Power_{C2} – 10 log BW_{C2} (in Hz))
 $= \text{CnC Ratio} - 10 \log (BW_{C1} / BW_{C2})$

If the two carriers have the same Symbol Rate / Bandwidth, then the CnC Ratio is same as the PSD Ratio.

F.4 Carrier-in-Carrier Automatic Power Control (CnC-APC)

F.4.1 Overview

A number of Comtech EF Data modems, including the CDM-625A, offer Automatic Uplink Power Control (AUPC) to mitigate the effects of rain fading and other link impairments.

It is important to note that the simple system employed in AUPC (whereby distant-end E_b/N_0 is monitored, and local power is increased when a degraded link is detected) has an undesirable characteristic, which leads to some operators not permitting its use on their transponders: The inability of 'classic' AUPC to determine at which side of link the fade (or other impairment) has occurred. More specifically:

- If the fade is at the local side, all is well – the drop in E_b/N_0 at the distant site corresponds exactly to the drop in power (due to excess attenuation) on the local uplink; when uplink power is increased, the power at the transponder does not exceed its clear-sky value.
- Conversely, if the fade occurs at the distant side, the AUPC system increases power in exactly the same way – but now, there is no excess uplink attenuation and, as a result, the clear-sky power at the satellite will be exceeded.

In a transponder with many carriers using AUPC, a fade event at the 'wrong' side can cause many carriers to simultaneously increase power beyond their authorized maximums, leading to intermod problems, adjacent channel interference (ACI) issues, and in some extreme cases, saturation of the transponder.

When considering power control in the Carrier-in-Carrier case, not only must the issue of exceeding allocated power limits be respected, but the problem of driving CnC ratios outside working limits during fading must also be taken into account.

F.4.2 AUPC and Carrier-in-Carrier in the CDM-625A

The CDM-625A currently permits 'classic' AUPC when Carrier-in-Carrier mode is in operation, but this does nothing to stop the problem of exceeding power limits when the fade is on the 'wrong' side. To limit the impact of this, you are constrained to 3 dB of permitted power increase. Depending on the satellite band, and the depth and rapidity of the fade, this constraint may curtail the effectiveness of the system.

F.4.3 The CnC Automatic Power Control Algorithm

In addressing the shortcomings of 'classic' AUPC, Comtech EF Data has determined from its studies of the unique problems of power control in CnC systems that there is sufficient information available (CnC ratio, power level, E_b/N_0 , RSL, etc.) on the local and distant sides to control power at each end without exceeding the total composite power allocated to each carrier in the CnC pair. Furthermore, the power control algorithm developed by Comtech EF Data ensures that the CnC ratio remains within the correct working range.

To recap, consider this diagram:

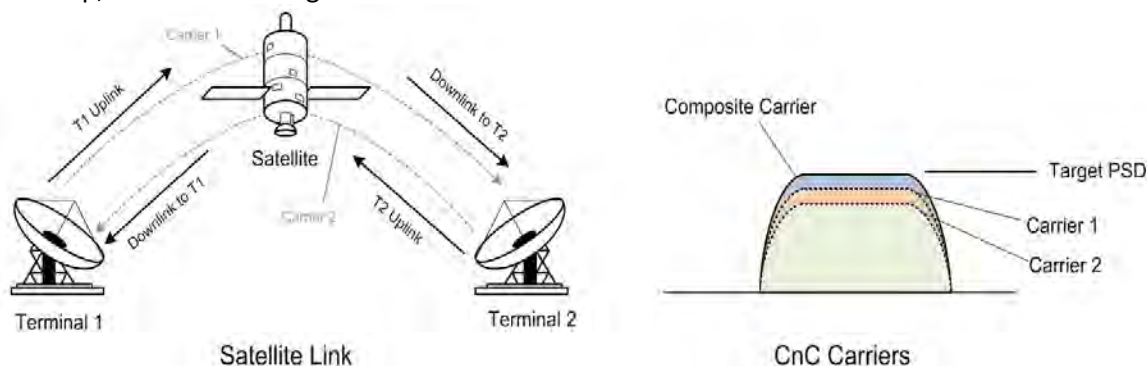

Whenever power is adjusted on Carrier 1, the power in Carrier 2 needs to be adjusted so the composite carrier power remains constant (or does not exceed its allocated limit), while keeping the CnC ratio within limits.

There are two distinct phases to the CnC-APC algorithm:

- 1) In order for the CnC-APC algorithm to work effectively, it must first analyze the CnC Ratio and E_b/N_0 margins on each side of the link, and based on the starting conditions, re-distribute power between the two ends so that good protection against fades can be achieved. This process is referred to as re-balancing, and is done so that total composite power (TCP) in the two carriers remains constant (within ± 0.5 dB).

In this process, both sides of the link calculate power changes, based on their ability to see not only local parameters, including CnC Ratio, E_b/N_0 , Receive signal level, power level and max power increase, but those of the modem at the other end of the link. After these calculations are performed, a comparison of the results is performed, and if they are in close agreement, the power changes are implemented.

It may not always be possible to drive the powers to an optimum point. The calculations take into account:

- The minimum and maximum power levels possible in the modem (as affected by the selected operating band – 70/140 MHz IF versus L-Band).
- If the user-programmed value that determines the maximum permitted increase in Tx power for the terminal would be exceeded. **This is a very important value**, and you must know exactly how far from compression his transmit RF chain is operating. As an example, if, under normal clear sky conditions, you determine that the backoff from compression is -3 dB, and under no circumstances must the RF chain ever go past -1 dB, the maximum power increase that can be permitted is 2 dB. You enter this into the CDM-625A as a setup parameter. If this value is ignored, or incorrectly entered, compression or saturation could occur, either during the initial re-balance, or during a fade event. This parameter is referred to as $TPLI_{max}$ (Transmit Power Level Increase, max).

- If the power changes calculated would put the CnC Ratio out of its working range.
- If the Rx signal level is above its minimum level – if it is not, the CnC Ratio monitor will not be accurate, which is essential correct calculations.
- If the power change would result in the Eb/No margin on either side becoming negative (*see below*).

At the end of the re-balance procedure, the modem will display the result:

- Full re-balance.
- Partial re-balance.
- Some issue was found that prevents a re-balance.

In the case of a partial or no re-balance, the modem displays the reason for this result; you can then adjust an operating parameter and try again.



CAUTION – READ THESE IMPORTANT NOTES:

- **You should be aware that after the re-balance has been carried out, it is very likely that the CnC Ratio will not be at 0dB, and the Eb/No margins will not be equal. This is particularly true for cases where there is an asymmetry in antenna size, terminal G/T, symbol rate etc. This is an inherent function of the re-balancing algorithm, and is not a cause for concern.**
- **You should only attempt to do a re-balance if it is known with certainty that there are CLEAR SKY conditions at BOTH SIDES OF THE LINK.**

It is not necessary that there be a person at each end – the re-balance can be initiated from either side, with the other side unattended.

Following the re-balance, the CDM-625A stores key parameters, such as Tx Power level, that are referred to as the **Home State**. In the event of a loss of communication between the two sides, the modem will revert to Home State, which is a known safe condition that will not cause TCP to be exceeded. Once the link conditions have improved so that communication is re-established, CnC-APC will automatically re-activate.

- 2) In the second phase of the algorithm, Eb/No, CnC ratio, and RSL are continuously monitored. For every combination of the modulation, FEC type and FEC code rate, the modem calculates an **Eb/No margin**. An Eb/No margin of 0 dB is arbitrarily determined to be the Eb/No value that produces a BER of 1×10^{-7} at the output of the decoder, plus 1 dB. If the algorithm senses that Eb/No margin is dropping, power is increased at one or both ends of the link, but in a manner that ensures that TCP is not exceeded. In the vast majority of cases the TCP during a fade will not exceed its clear-sky value by more than +0.5 dB.

The algorithm uses a number of inputs, from both sides of the link, including knowledge of the satellite band in use (which you are required to know at the time of set-up). The characteristics of rain fading changes with frequency, and there are different models for C-Band, X-Band, Ku-Band, and Ka-Band. Not only does downlink attenuation vary as a function rain rate, but in some cases (depending on the G/T of the terminals at each end, and the satellite transponder itself) may be dominated by an increase in receive noise temperature when the antenna is pointing through rain and clouds, rather than 'cold' sky.

The depth of fade that the CnC-APC algorithm can tolerate is highly dependent on a number of factors, including:

- The CnC Ratio and E_b/N_0 margins following a re-balance. In general, with a highly asymmetric link, where CnC Ratio is not close to zero, the tolerance to fade depth on one side will be less than the other.
- The maximum permitted level of power increase that you have defined. If, for example, you have programmed a TPLImax value of 2 dB (because that's the only headroom the RF chain has) you should not expect the link to tolerate a fast 10 dB fade at Ku-Band.

F.4.4 CnC-APC Framing

In order to provide a two-way communications link between the two ends, CnC-APC requires an overhead channel (very much like EDMAC, or one of its variants, which is used in AUPC).

Recognizing that this overhead needs to have a minimal impact on occupied bandwidth and E_b/N_0 performance, the overhead has been kept as low as possible:

- The overhead rate is fixed at 0.5%, causing the symbol rate of the carrier to grow by an almost imperceptible amount (no need to re-calculate channel spacing) and causing a loss of E_b/N_0 performance of only 0.02dB.
- This choice of overhead rate effectively gives you the functionality of the CnC-APC channel without having to pay a penalty in power or bandwidth – it's essentially free.

The CnC-APC channel constantly passes a number of metrics and parameters, including CnC Ratio, E_b/N_0 , Receive signal level, power level and max power increase, as well as information required for the initial set-up, including the modem operating band (L-Band or 70/140 MHz), and the satellite band in use.

In addition to the information fields in the frame, there is a control field that permits commands to be sent from one side or the other during initial re-balancing, and re-balancing during fade events.

Note that the CnC-APC frame size (and the latency associated with it) limits the lower end of the range of bit rates that are supported to 64 kbps. If you select the CnC-APC mode at a data rate below 64 kbps, an error message will be generated if a re-balance operation is requested.

F.4.4.1 CnC-APC Framing and the Self-Locking Problem

Self-locking is a problem that has been previously reported to Comtech EF Data Customer Service on CnC links that have identical data rates, FEC and modulation.

In the case where both ends of the link are up and running, the CnC canceller performs as intended. However, if the carrier at the remote side stops transmitting a carrier, the CnC canceller will still cancel the interferer (its own outbound Tx signal), but the cancelation is not perfect (it may be in the order -30 dB) and hence a weak signal appears at the input to the demodulator that, because of the correct settings of data rate, FEC and modulation, is sometimes acquired by the demod. This can sometimes be an issue because, although the Tx carrier from the distant side is not transmitting, no demodulator alarm is generated and hence the local end is not alerted – and data being transmitted is looped back to the receiver, and back into the network.

The use of CnC-APC framing provides the means to eliminate the self-locking problem. Rather than having an identical framing structure for the local and distant sides of the link, by designating each side as **Side 'A'** and **Side 'B'**, each side has a different framing structure and is therefore non-identical and incompatible. This makes it impossible for a modem in this CnC mode to lock to itself. With this approach, there is no 'master-slave' relationship – both sides are peers, and either side can be designated as **'A'** or **'B'**.

F.4.5 CnC-APC Response Time

After CnC-APC is activated, power may be modified at a rate that does not exceed once every 1.75 seconds. This rate has been determined by taking into account the round trip satellite delay, the time taken to accurately determine CnC Ratio and Eb/No following a power adjustment, and the latency of the CnC-APC frame itself. The overall response time of the control system is therefore limited by these factors, and deep fading events that exceed approximately 1 dB/second are likely to be too fast for CnC-APC (or any other 'classic' scheme) to respond to. Users should bear in mind that these limitations in response time are inherent in schemes involving round-trip delays from geostationary satellites.

F.4.6 CnC-APC Setup

To set up CnC-APC, carefully follow and understand the steps as presented here.



CAUTION – This procedure should be done only when there are CLEAR SKY conditions at both ends of the link.

- 1) Set up the CnC link in 'normal' mode according to the instructions earlier in this appendix, and according to an appropriately calculated link budget.

The initial selection of CnC-APC normally requires that a person be present at both ends, to coordinate the change of CnC from 'normal' to CnC-APC mode. Alternately, if an IP connection is available to the distant end *that does not depend on the satellite link for primary connectivity*, the setup can be performed remotely.

Once the link is established, a further re-balance, activation or suspension does not require another person to be present, or independent remote IP access.

- 2) Once the 'normal' CnC link has been established, determine that the link is stable and that it has an acceptable link margin at both ends.
- 3) Decide, arbitrarily, which is **Side 'A'**, and which is **Side 'B'**.
- 4) From the CDM-625A front panel, select the **CONFIG → CnC → Mode** menu:

```
CnC Mode: APC,Side A,C-Band      (Off, On, APC)
Activate? N (Y,N) APC is not active  (◀ ▶ ⬇)
```

On the top line, use the ▲ ▼ arrow keys to select the appropriate CnC operating mode. Available selections are:

- Off
- On (normal)
- APC,Side 'A',C-Band
- APC,Side 'A',Ku-Band
- APC,Side 'A',Ka-Band
- APC,Side 'B',C-Band
- APC,Side 'B',X-Band
- APC,Side 'B',Ku-Band
- APC,Side 'B',Ka-Band



If it is not known which satellite band is being used, no attempt should be made to engage CnC-APC.

Once the mode has been selected, press **ENTER** – do not select **Activate** (on the bottom line) yet.

Note the following:

- If **Side 'A'** is selected at both sides, or **Side 'B'** is selected at both sides, both modems will display a **Frame Sync** fault (under Rx faults). No further action is possible until this error has been corrected.
 - If different satellite bands are selected on each side (for instance, Side 'A' is Ku-Band, while Side 'B' is C-Band) the modem will display an **APC Band Mismatch** fault (under Rx faults). No further action is possible until this error has been corrected.
- 5) Based on the known RF terminal equipment in use, determine a value for the maximum allowed power increase ($TPLI_{max}$) and then set this value. From the CDM-625A front panel, select the **CONFIG → Tx → Power** menu:

```
Output Power Mode = CnC-Auto-Power-Control
Level = -25.0dBm MaxPwrIncrease=2.5dB  (◀ ▶ ⬇)
```

On the bottom line, to edit the power output level and the maximum permitted increase in power level when in APC Mode: Use the ◀ ▶ arrow keys to select a digit to edit, and then use the ▲ ▼ arrow keys to change the value of that digit. Press **ENTER**.

Note that when APC is in an active state, the value of the power level displayed in the bottom left will show **'AUTO'**.

- 6) Go back to the **SELECT: CONFIG → CnC → MODE** menu. On the bottom line, which will be displaying **Activate? N (Y,N)**, use the ▲ ▼ arrow keys to select **Y (Yes)** and then press **ENTER**.

The modem display will update, similar to the following example:

```
The CnC Mode: APC,Side 'A',C-Band (Off,On,APC)
Suspend? N (Y,N) OK-ReBalance Done (◀▶◆)
```

The message on the bottom line can be any one of the following:

Displayed Message	Expanded Meaning
OK-ReBalance Done	Full re-balance was achieved
OK(P)CnCRatio→ Lim	Partial re-balance, limited by CnC ratio approaching its working limit
OK(P)-LocalPwr→ Min	Partial re-balance, limited by local power approaching its lower limit
OK(P)-LocalPwr→ Max	Partial re-balance, limited by local power approaching its upper limit
OK(P)-LocalPwr→ Lim	Partial re-balance, limited by local power approaching TPL_{max}
OK(P)-DistPwr→ Min	Partial re-balance, limited by distant power approaching its lower limit
OK(P)-DistPwr→ Max	Partial re-balance, limited by distant power approaching its upper limit
OK(P)-DistPwr→ Lim	Partial re-balance, limited by local power approaching TPL_{max}
OK(P)-Incomplete	Partial re-balance, algorithm did not fully converge
No APC Frame Sync	Communication not possible – no APC frame sync
Locl EbNo too high	The local Eb/No is too high (>16 dB) to determine re-balance params
Dist EbNo too high	The distant Eb/No is too high (>16 dB) to determine re-balance params
DistEnd ReBal fail	The distant end failed to re-balance
DistEnd NoResponse	The distant end failed to respond
Fail-CalcMismatch	No Re-balance - the solution calculated by each end does not match
CnC Ratio too high	The CnC ratio is too high (>9 dB) for re-balancing to be attempted
LoclMargin too low	There is insufficient local Eb/No margin for an APC re-balance
DistMargin too low	There is insufficient local Eb/No margin for an APC re-balance
Rx DataRate<64kbps	The Rx data rate needs to be 64 kbps or higher for APC
Rx DataRate<64kbps	The Tx data rate needs to be 64 kbps or higher for APC
Local RSL too low	The local RSL is below the minimum for the operating symbol rate
Dist RSL too low	The distant RSL is below the minimum for the operating symbol rate

If the message shown begins with **OK**, then after approximately 5 seconds, the display changes as per the following example:

```
The CnC Mode: APC,Side A,C-Band (Off, On, APC)
Suspend? N (Y,N) APC is active (◀ ▶ ⬇)
```

At this point, as indicated on the bottom line of the display, CnC-APC is **active**.

To suspend CnC-APC at any time: On the bottom line, which will be displaying **Suspend? N (Y,N)**, use the **▲ ▼** arrow keys to select **Y (Yes)** and then press **ENTER**. The CnC-APC status message on the bottom line of the display will update accordingly, as per the following example:

```
The CnC Mode: APC,Side A,C-Band (Off, On, APC)
Activate? N (Y,N) APC is not active (◀ ▶ ⬆)
```

Note that, when CnC-APC is suspended, it is de-activated on **both** sides.

If a message other than **OK** is displayed after attempting to perform a re-balance, the CnC-APC system will not activate, and you should correct the link conditions before re-attempting to activate it.



CAUTION – IMPORTANT NOTE:

When CnC-APC is active, you are not permitted to change configuration parameters that potentially affect the operation of CnC-APC (modulation type, FEC type, code rate, framing, etc). If you attempt to change one of these parameters either locally or remotely, the change will not be accepted. In order to change these configuration parameters, CnC-APC needs to be suspended first. Following the changes, you should re-activate CnC-APC. Be aware that the re-activation will be preceded with a new re-balance operation.

F.4.7 CnC-APC Redundancy Support Notes

- 1) The CnC-APC feature fully supports 1:1 redundancy. Note that, as is required with standard CnC 1:1 redundancy operation, a PMSI cable is required to connect the two units in a 1:1 pair.



Sect. 6.2.1.8.4 CONFIG: CnC → PMSI-Control (Chapter 6. FRONT PANEL OPERATION)

- 2) At this time, 1:N redundancy in the CRS-300/CRS-500 is not yet supported – a firmware update for these switches will be available in the future. Please consult Comtech EF Data Technical Support for updated information.

F.5 DoubleTalk Carrier-in-Carrier Specifications

Operating Mode	Requires the two links to share a common carrier frequency (Outbound and Inbound symbol rates do not have to be equal)						
Power Spectral Density Ratio and CnC Ratio	<p>BSPK/QPSK/8-PSK/8-QAM: -7 dB to +11 dB (ratio of power spectral density, outbound interferer to desired inbound)</p> <p>16-QAM: -7 dB to +7 dB (ratio of power spectral density, outbound interferer to desired inbound)</p> <p>Note: With asymmetric carriers the absolute power ratio (or CnC ratio) would be different, depending on the ratio of the symbol rates.</p> <p>Example:</p> <ul style="list-style-type: none"> • Outbound interferer = 1 Msymbols/sec • Desired Inbound = 500 ksymbols/sec • Ratio of power spectral density = +7 dB <p>Absolute power ratio (CnC Ratio) = +7dB + (10 log Outbound/desired symbol rate) = +10 dB</p>						
Maximum Symbol Rate Ratio	3:1 (TX:RX or RX:TX)						
Inbound/Outbound frequency uncertainty	<p>Within the normal acquisition range of the demod, as follows:</p> <ul style="list-style-type: none"> • Below 64 ksymbols/sec: ± 1 to $\pm (Rs/2)$ kHz, where Rs = symbol rate in ksymbols/sec • Between 64 and 389 ksymbols/sec: ± 1 up to a maximum of ± 32 kHz • Above 389 ksymbols/sec: ± 1 to $\pm (0.1Rs)$ kHz, up to a maximum of ± 200 kHz 						
Delay range	0-330 ms						
Eb/No Degradation (equal Inbound/Outbound power spectral density)	<table style="width: 100%; border: none;"> <tr> <td style="width: 33%;">• BPSK = 0.3dB</td> <td style="width: 33%;">• QPSK = 0.3dB</td> <td style="width: 33%;">• OQPSK = 0.3dB</td> </tr> <tr> <td>• 8-PSK = 0.5dB</td> <td>• 8-QAM = 0.4dB</td> <td>• 16-QAM = 0.6dB</td> </tr> </table> <p>For +10 dB power spectral density ratio (outbound interferer 10 dB higher than desired inbound) add an additional 0.3 dB</p>	• BPSK = 0.3dB	• QPSK = 0.3dB	• OQPSK = 0.3dB	• 8-PSK = 0.5dB	• 8-QAM = 0.4dB	• 16-QAM = 0.6dB
• BPSK = 0.3dB	• QPSK = 0.3dB	• OQPSK = 0.3dB					
• 8-PSK = 0.5dB	• 8-QAM = 0.4dB	• 16-QAM = 0.6dB					
Monitor Functions	<ul style="list-style-type: none"> • Delay, in milliseconds • Frequency offset (between outbound interferer and desired inbound). 100 Hz resolution • CnC ratio, in dB (ratio of absolute power, outbound interferer to desired inbound) 						
CnC Monitor Accuracy	± 0.2 dB for symmetric symbol rate						

F.6 Carrier-in-Carrier Summary

Comtech EF Data's DoubleTalk Carrier-in-Carrier can provide significant savings in operational expenses. The following should be considered when evaluating DoubleTalk Carrier-in-Carrier:

- DoubleTalk Carrier-in-Carrier can only be used for full duplex links where the transmitting earth station is able to receive itself.
- DoubleTalk Carrier-in-Carrier can be used in both bandwidth limited and power limited situations.
- The maximum savings is generally achieved when the original link is symmetric in data rate.

F.7 Glossary

Bandwidth, Allocated or Occupied

Bandwidth or Allocated Bandwidth or Occupied Bandwidth is the frequency space required by a carrier on a transponder.

For example: A Duplex 10 Mbps Circuit with 8PSK Modulation, FEC Rate 3/4 and 1.4 Spacing requires:

- $\text{Allocated BW} = (\text{DR} / \text{SE}) * \text{CSF} [(\text{Data Rate} / \text{Spectral Efficiency}) * \text{Carrier Spacing Factor}]$
- $\text{Allocated BW} = 6.222 \text{ MHz} = (10 / 2.25) * 1.4$

For a 36 MHz transponder, 6.222 MHz corresponds to 17.3% Bandwidth Utilization.

Bandwidth, Leased (LBW)

Almost all satellite operators charge for the Leased Bandwidth (LBW). Leased Bandwidth or Leased Resource is the greater of the Allocated Bandwidth and Power Equivalent Bandwidth.

For example: If a carrier requires 3 MHz of Allocated BW and 4.5 MHz of PEB, the Leased Bandwidth is 4.5 MHz

Bandwidth, Power Equivalent (PEB)

Power Equivalent Bandwidth (PEB) is the transponder power used by a carrier, represented as bandwidth equivalent.

PEB Calculation Example:

- Transponder EIRP = 37 dBW
- Output Backoff (OBO) = 4 dB
- Available EIRP = $37 - 4 = 33 \text{ dBW} = 10^{3.3} = 1995.26 \text{ Watts}$
- Transponder Bandwidth = 36 MHz

- Power Available / MHz = $1995.26 / 36 = 55.424$ W
- If a carrier uses 24 dBW, its PEB = $10^{2.4} / 55.424 = 4.532$ MHz

This corresponds to 12.59% of available transponder power.

CnC Ratio

Ratio of Interfering Carrier Power to Desired Carrier Power (unit in dB).

The *Interfering Carrier* is the Tx Carrier from local modulator; the *Desired Carrier* is the carrier from the distant end received by the local demodulator.

At the station transmitting C1: CnC Ratio (in dB) = PowerC1 (in dBm) – PowerC2 (in dBm)

Eb/No

Ratio of Energy per bit (*E_b*) to Noise density (*N_o*) (unit in dB):

- $E_b/N_o = C/N_o - 10\log(DR)$ [where DR is the Data Rate]
- $E_b/N_o = E_s/N_o - 10\log(SE)$ [where SE is Spectral Efficiency]

E_s/N_o

Ratio of Energy per symbol (*E_s*) to Noise density (*N_o*) (unit in dB):

- $E_s/N_o = C/N_o - 10\log(SR)$ [where SR is the Symbol Rate]
- $E_s/N_o = E_b/N_o + 10\log(SE)$ [where SE is Spectral Efficiency]

C/N

Ratio of Carrier Power (*C*) to Noise (*N*) (unit in dB):

Equivalent to E_s/N_o when calculated in the Symbol Rate bandwidth.

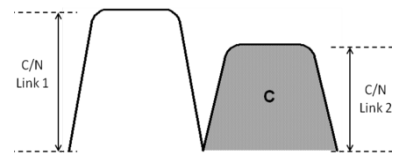

C/N_o

Ratio of Carrier Power (*C*) to Noise Density (*N_o*) (unit in dBHz)

Co+No/No

Ratio of Carrier Density (C_o) + Noise (N_o) to Noise Density (N_o) (unit in dB):

$$C/N = C/N_o - 10\log(B) \text{ [where } B \text{ is bandwidth in Hz]}$$

$$E_b/N_o = C/N_o - 10\log(DR) \text{ [where } DR \text{ is data rate in bits/sec]}$$

$$= C/N + 10\log(B) - 10\log(DR)$$

$$= C/N - 10\log(SE) \text{ [where } SE \text{ is Spectral Efficiency]}$$

$$E_b/N_o = 10\log(10^{((C_o+N_o/N_o)/10)} - 1) - 10\log(SE) \text{ [where } SE \text{ is Spectral Efficiency]}$$

[Note: Spectral Efficiency is in bps / Hz]

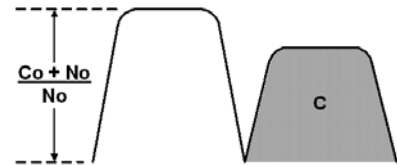

Power Spectral Density (PSD)

Power Spectral Density (PSD) is the signal power per unit bandwidth: dBW / Hz or dBm / Hz

For example: Signal power = 20 dBm

Signal bandwidth = 5 MHz

$$PSD = 20 - 10 * \log(5,000,000) = -46.99 \text{ dBm / Hz}$$

PSD Ratio

Ratio of Power Spectral Density (PSD) of the interfering carrier to the desired carrier.

If looking at the two carriers side-by-side on a spectrum analyzer:

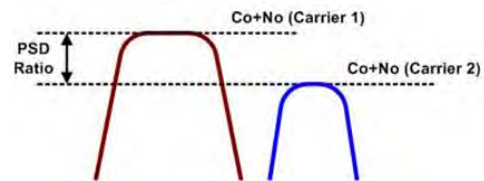

Quasi Error Free (QEF)

Quasi Error Free (QEF) corresponds to PER $\sim 10^{-7}$

[Note: PER (packet error rate) is based upon a 188-byte MPEG frame size]

Spectral Efficiency (SE)

Ratio of the Data Rate to the Symbol Rate.

Symbol Rate & Data Rate

Symbol Rate and Data Rate are related:

- $DR = SR * SE$ [Data Rate = Symbol Rate * Spectral Efficiency]
- $SR = DR / SE$ [Symbol Rate = Data Rate / Spectral Efficiency]

Appendix G. E_b/N_o MEASUREMENT

Although the CDM-625A Advanced Satellite Modem calculates and displays the value of receive E_b/N_o on the front panel of the unit, it is sometimes useful to measure the value using a spectrum analyzer, if one is available.

The idea is to accurately measure the value of $(C_o+N_o)/N_o$, (Carrier density + Noise density/Noise density). This is accomplished by tuning the center frequency of the spectrum analyzer to the signal of interest, and measuring the difference between the peak spectral density of the signal (the flat part of the spectrum shown) and the noise density.

To make this measurement:

- Use a vertical scale of 1 or 2 dB/division.
- Set the Resolution Bandwidth of the Spectrum Analyzer to < 20 % of the symbol rate.
- Use video filtering and/or video averaging to reduce the variance in the displayed trace to a low enough level that the difference can be measured to within 0.2dB.
- Place a marker on the flat part of the signal of interest, then use the MARKER DELTA function to put a second marker on the noise to the side of the carrier. This value is $(C_o+N_o)/N_o$, in dB.
- Use this value of $(C_o+N_o)/N_o$ in the table on the following page to determine the E_b/N_o . You will need to know the operating mode to read from the appropriate column.
- If the $(C_o+N_o)/N_o$ value measured does not correspond to an exact table entry, interpolate using the two nearest values.

Note that the accuracy of this method degrades significantly at low values of $(C_o+N_o)/N_o$ (approximately less than 6 dB).

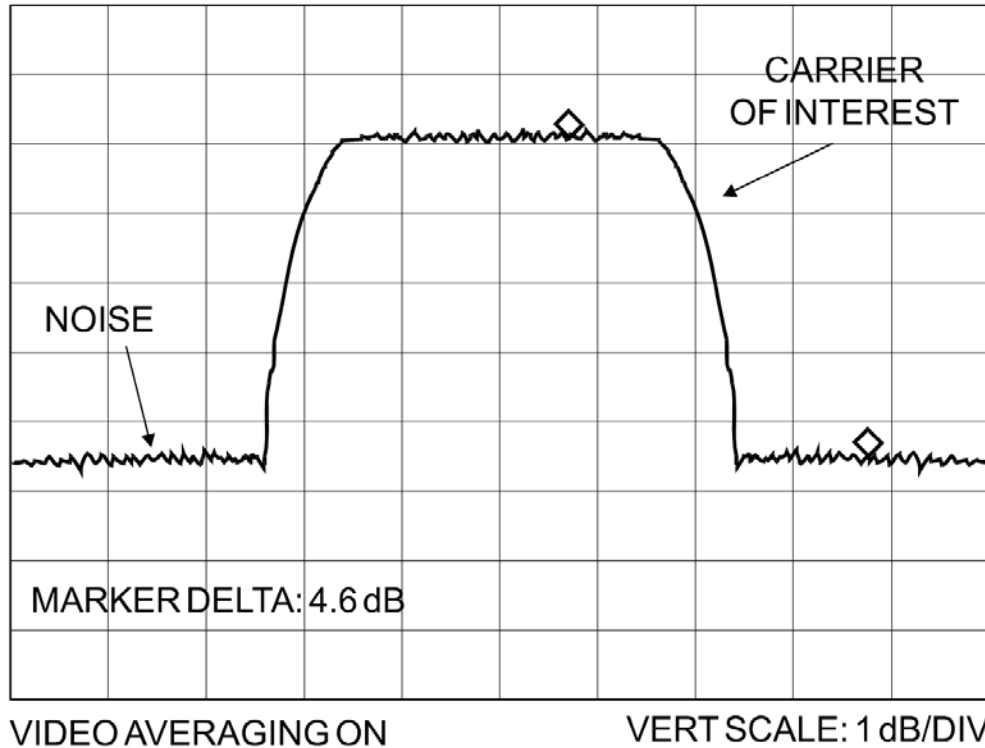

Example: In the above diagram, the $(C_o+N_o)/N_o$ measured is 4.6 dB. If Rate 1/2 QPSK is used, this corresponds to an E_b/N_o of approximately 2.6 dB. The exact relationship used to derive the table values is as follows:

$$E_b/N_o = 10 \log_{10} (10^{(C_o+N_o/N_o)/10} - 1) - 10 \log_{10} (\text{FEC Code Rate}) - 10 \log_{10} (\text{bits/symbol})$$

Where:

- E_b/N_o and $(C_o+N_o) / N_o$ are expressed in dB;
- $\text{bits/symbol} = 1$ for BPSK;
- $\text{bits/symbol} = 2$ for QPSK;
- $\text{bits/symbol} = 3$ for 8-PSK/8-QAM;
- $\text{bits/symbol} = 4$ for 16-QAM;
- **FEC Code Rate** for 'uncoded' = 1.



Pay close attention to the sign of the middle term.



See Appendix J. ESC++ for details of how the E_b/N_o performance degrades when ESC++ is used, particularly at lower data rates, where the percentage overhead is high.

(Co+No) /No	Eb/No Uncoded BPSK	Eb/No Rate 1/2 BPSK	Eb/No Rate 21/44 BPSK	Eb/No Rate 5/16 BPSK	Eb/No Uncoded QPSK	Eb/No Rate 1/2 QPSK	Eb/No Rate 3/4 QPSK	Eb/No Rate 7/8 QPSK	Eb/No Rate 0.95 QPSK	Eb/No Rate 2/3 8-PSK	Eb/No Rate 3/4 8-PSK	Eb/No Rate 7/8 8-PSK	Eb/No Rate 0.95 8-PSK	Eb/No Rate 3/4 16-QAM	Eb/No Rate 7/8 16-QAM
1.4	-	-	-	0.8	-	-	-	-	-	-	-	-	-	-	-
1.6	-	-	-	1.5	-	-	-	-	-	-	-	-	-	-	-
1.8	-	-	-	2.1	-	-	-	-	-	-	-	-	-	-	-
2.0	-	0.7	0.9	2.7	-	-	-	-	-	-	-	-	-	-	-
2.2	-	1.2	1.4	3.2	-	-	-	-	-	-	-	-	-	-	-
2.4	-	1.7	1.9	3.7	-	-	-	-	-	-	-	-	-	-	-
2.6	-	2.1	2.3	4.2	-	-	-	-	-	-	-	-	-	-	-
2.8	-	2.6	2.8	4.6	-	-	-	-	-	-	-	-	-	-	-
3.0	0.0	3.0	3.2	5.0	-	-	-	-	-	-	-	-	-	-	-
3.5	0.9	3.9	4.1	5.9	-	0.9	-	-	-	-	-	-	-	-	-
4.0	1.8	4.8	5.0	6.8	-	1.8	-	-	-	-	-	-	-	-	-
4.5	2.6	5.6	5.8	7.6	-	2.6	0.8	-	-	-	-	-	-	-	-
5.0	3.3	6.3	6.5	8.4	-	3.3	1.5	0.9	-	-	-	-	-	-	-
5.5	4.1	7.1	7.3	9.1	1.1	4.1	2.3	1.7	1.3	-	-	-	-	-	-
6.0	4.7	7.7	7.9	9.8	1.7	4.7	2.9	2.3	1.9	-	-	-	-	-	-
6.5	5.4	8.4	8.6	10.4	2.4	5.4	3.6	3.0	2.6	-	-	-	-	-	-
7.0	6.0	9.0	9.2	11.1	3.0	6.0	4.2	3.6	3.2	-	-	-	-	-	-
7.5	6.6	9.6	9.8	11.7	3.6	6.6	4.8	4.2	3.8	-	-	-	-	-	-
8.0	7.3	10.3	10.5	12.3	4.3	7.3	5.5	4.9	4.5	-	-	-	-	-	-
8.5	7.8	10.8	11.0	12.9	4.8	7.8	6.0	5.4	5.0	4.8	-	-	-	-	-
9.0	8.4	11.4	11.6	13.4	5.4	8.4	6.6	6.0	5.6	5.4	4.9	-	-	-	-
9.5	9.0	12.0	12.2	14.0	6.0	9.0	7.2	6.6	6.2	6.0	5.5	4.8	4.5	-	-
10.0	9.5	12.5	12.7	14.6	6.5	9.5	7.7	7.1	6.7	6.5	6.0	5.3	5.0	-	-
10.5	10.1	13.1	13.3	15.1	7.1	10.1	8.3	7.7	7.3	7.1	6.6	5.9	5.6	5.3	-
11.0	10.6	13.6	13.8	15.7	7.6	10.6	8.8	8.2	7.8	7.6	7.1	6.4	6.1	5.8	5.2
11.5	11.2	14.2	14.4	16.2	8.2	11.2	9.4	8.8	8.4	8.2	7.7	7.0	6.7	6.4	5.8
12.0	11.7	14.7	14.9	16.7	8.7	11.7	9.9	9.3	8.9	8.7	8.2	7.5	7.2	6.9	6.3
12.5	12.2	15.2	15.4	17.3	9.2	12.2	10.4	9.8	9.4	9.2	8.7	8.0	7.7	7.4	6.8
13.0	12.8	15.8	16.0	17.8	9.8	12.8	11.0	10.4	10.0	9.8	9.3	8.6	8.3	8.0	7.4
13.5	13.3	16.3	16.5	18.3	10.3	13.3	11.5	10.9	10.5	10.3	9.8	9.1	8.8	8.5	7.9
14.0	13.8	16.8	17.0	18.8	10.8	13.8	12.0	11.4	11.0	10.8	10.3	9.6	9.3	9.0	8.4
14.5	14.3	17.3	17.5	19.4	11.3	14.3	12.5	11.9	11.5	11.3	10.8	10.1	9.8	9.5	8.9
15.0	14.9	17.9	18.1	19.9	11.9	14.9	13.1	12.5	12.1	11.9	11.4	10.7	10.4	10.1	9.5
15.5	15.4	18.4	18.6	20.4	12.4	15.4	13.6	13.0	12.6	12.4	11.9	11.2	10.9	10.6	10.0
16.0	15.9	18.9	19.1	20.9	12.9	15.9	14.1	13.5	13.1	12.9	12.4	11.7	11.4	11.1	10.5
16.5	16.4	19.4	19.6	21.4	13.4	16.4	14.6	14.0	13.6	13.4	12.9	12.2	11.9	11.6	11.0
17.0	16.9	19.9	20.1	21.9	13.9	16.9	15.1	14.5	14.1	13.9	13.4	12.7	12.4	12.1	11.5
17.5	17.4	20.4	20.6	22.4	14.4	17.4	15.6	15.0	14.6	14.4	13.9	13.2	12.9	12.6	12.0
18.0	17.9	20.9	21.1	23.0	14.9	17.9	16.1	15.5	15.1	14.9	14.4	13.7	13.4	13.1	12.5
18.5	18.4	21.4	21.6	23.5	15.4	18.4	16.6	16.0	15.6	15.4	14.9	14.2	13.9	13.6	13.0
19.0	18.9	21.9	22.1	24.0	15.9	18.9	17.1	16.5	16.1	15.9	15.4	14.7	14.4	14.1	13.5
19.5	19.5	22.5	22.7	24.5	16.5	19.5	17.7	17.1	16.7	16.5	16.0	15.3	15.0	14.7	14.1
20.0	20.0	23.0	23.2	25.0	17.0	20.0	18.2	17.6	17.2	17.0	16.5	15.8	15.5	15.2	14.6

Notes: IBS Framing: add 0.2 dB EDMAC Framing: rates below 2048 kbps add 0.2 dB, otherwise 0 Reed-Solomon: add an additional 0.4 dB to the values shown

Appendix H. EDMAC CHANNEL

H.1 Overview

H.1.1 EDMAC

EDMAC is the acronym for **E**MBEDDED **D**ISTANT-END **M**ONITOR **A**ND **C**ONTROL. This feature permits user access to the M&C features of modems that are at the distant-end of a satellite link. This is accomplished by adding extra information to your data, but in a manner that is otherwise transparent.

On the transmit side:

The data is split into frames – each frame containing 1008 bits (except Rate 21/44 BPSK Turbo, or when the data rates exceed 2048 kbps, where the frame length is 2928 bits, and Rate 5/16 BPSK Turbo where the frame length is 3072 bits). 48 bits in each frame are overhead, and the rest of these bits are user data. This increases the rate of transmission by 5% (approximately 1.5% for the Turbo BPSK cases, and for all data rates greater than 2.048 Mbps). For example, if the user data rate is 64 kbps, the actual transmission rate will now be at 67.2 kbps. Note that you may also select EDMAC-2 framing, which always uses a 2928 bit frame, and yields a 1.6% overhead for all modulation types and data rates.

At the start of each frame, a 12-bit synchronization word is added. This allows the demodulator to find and lock to the start of frame. At regular intervals throughout the frame, additional data bytes and flag bits are added (a further 36 bits in total). It is these additional bytes that convey the M&C data.

When framing is used, the normal V.35 scrambler is no longer used. This V.35 approach is called 'self synchronizing' because no external information is required in the receiver in order for the de-scrambling process to recover the original data.

The disadvantage of this method is that it multiplies errors. On average, if one bit error is present at the input of the descrambler, three output errors are generated. However, there is an alternative when the data is in a framed format: in this case, a different class of scrambler may be used – one that uses the start of frame information to start the scrambling process at an exact known state.

In the receiver, having synchronized to the frame, the de-scrambler can begin its processing at exactly the right time. This method does not multiply errors, and therefore has a clear advantage over V.35 scrambling. This is fortunate, as there is a penalty to be paid for adding the

framing: by adding the extra 5% to the transmitted data rate, the effective E_b/N_0 that is seen will degrade by a factor of $10\log(1.05)$, or 0.21 dB (0.07dB in the case of the two BPSK Turbo rates or EDMAC-2).

The use of an externally synchronized scrambler and descrambler almost exactly compensates for this degradation. The net effect is that you will see effectively identical BER performance, whether or not framing is used.

On the receive side:

When the demodulator locks to the incoming carrier, it must go through the additional step of searching for and locking to the synchronization word. This uniquely identifies the start of frame, and permits the extraction of the overhead bytes and flag bits at the correct position within the frame. Additionally, the start of frame permits the de-scrambler to correctly recover the data: your data is extracted and sent through additional processing in the normal manner. The extracted overhead bytes are examined to determine if they contain valid M&C bytes.

H.1.2 Drop & Insert ++

A new variation of EDMAC is available with D&I++ framing. With this, each frame contains 2944 bits, with 64 overhead bits and 2880 user data bits. The portion of the overhead used for the EDMAC link performs identically to that of the EDMAC frame, but because D&I++ uses a smaller overhead, the two modes are not compatible with each other.

H.1.3 EDMAC-3

EDMAC-3 is another variation of EDMAC, which uses the same rate exchange as the original EDMAC frame:

- 21/20 (5%) at 2048 kbps and below
- 61/60 (1.6%) above 2048 kbps

With EDMAC-3, however, the EDMAC channel operates at 1/3 the rate of original EDMAC because most of the overhead is dedicated to carrying the remote modem's complete status information (including AUPC), so that it is available to the near-end modem at nearly real-time speed. EDMAC-3 is best suited for SNMP proxy applications.

H.2 M&C Connection

Data to be transmitted to the distant-end is sent to a local unit via the remote control port. A message for the distant-end is indistinguishable from a 'local' message – it has the same structure and content, only the address will identify it as being for a distant-end unit.

Before the M&C data can be successfully transmitted and received, pairs of units must be split into EDMAC Masters and EDMAC Slaves. Masters are local to the M&C User PC, and Slaves are distant-end.

Now, a unit that has been designated an EDMAC master not only responds to its own unique bus address, but it will also be configured to listen for the address that corresponds to its EDMAC Slave. When a complete message packet has been received by the EDMAC Master, it will begin to transmit this packet over the satellite channel, using the overhead bytes that become available.



The 'normal' protocol for the message packet is not used over the satellite path, as it is subject to errors. For this reason, a much more robust protocol is used which incorporates extensive error checking.

At the distant-end, the EDMAC slave, configured for the correct address, receives these bytes, and when a complete packet has been received, it will take the action requested, and then send the appropriate response to the EDMAC Master, using the return overhead path on the satellite link. The EDMAC Master assembles the complete packet, and transmits the response back to the M&C User PC.

Apart from the round-trip satellite delay, the M&C User PC does not see any difference between local and distant-end units – it sends out a packet, addressed to a particular unit, and gets back a response. It can be seen that the EDMAC Master simply acts as forwarding service, in a manner that is completely transparent.

This approach does not require any additional cabling; connection is made using the normal M&C remote port. Furthermore, you do not have to worry about configuring the baud rate of the M&C connection to match the lowest data rate modem in the system. The M&C system can have mixed data-rate modems, from 18 kbps to 25 Mbps, and still run at speeds in excess of 19200 baud. It should be pointed out that, at 18 kbps, the effective throughput of the overhead channel is only 56 asynchronous characters/second. For a message of 24 bytes, the time between sending a poll request and receiving a response will be around 1 second. (Note that when EDMAC-2 or either of the BPSK Turbo rates is in use, the overhead rate is reduced by a factor of three, and therefore the response time will be around 3 seconds.)

H.3 Setup Summary

To access a distant-end unit:

- Designate a Master/Slave pair: Master at the local-end, Slave at the distant-end.
- On the local-end unit, enable framing and EDMAC, define the unit as MASTER, and then enter the bus address. This is constrained to be 'base 10' meaning that only addresses such as 10, 20, 30, 40 etc, are allowed.
- Choose a unique bus address for the distant-end. This should normally be set to the 'base 10' address + 1. For example, if the MASTER unit is set to 30, choose 31 for the distant-end unit.
- On the distant-end unit, enable framing and EDMAC, define the unit as SLAVE, and then enter the bus address.
- Set the local-end unit to RS-485 remote control, and set the bus address of this local unit. The orange "REMOTE" Mode LED on the modem front panel should be lit.
- Once the satellite link has been established, connect the M&C User PC, and begin communications with both the local and distant end units.



EDMAC modes are fully compatible with AUPC modes.

Appendix J. ESC++

J.1 Overview

ESC is the acronym for **E**ngineering **S**ervice **C**hannel. The ESC++ mode of operation is a closed network frame structure that combines **A**utomatic **U**plink **P**ower **C**ontrol (AUPC) with a high speed asynchronous order-wire channel. AUPC works identically to what is offered with EDMAC and D&I++ framing, but is not compatible with either because ESC++ framing uses a different overhead percentage than the other closed network framing modes.

J.2 Overhead Details

Baud rates from 1200 to 38400 bits/sec are offered using EIA-232 or EIA-485 format. Three data formats are available: 8-N-1 (eight data bits, no parity, and one stop bit), 7-E-2 (seven data bits, even parity, and two stop bits), and 7-O-2 (seven data bits, odd parity, and two stop bits). The 9-pin ESC port is used for this data channel (see **Sect. 3.2.2.5 ESC (DB-9F)** in **Chapter 3. REAR PANEL CONNECTORS AND PINOUTS** for more information).

Because 38400 baud is the maximum rate available, the actual overhead percentage for ESC++ framing changes as the data rate increases, thereby saving bandwidth at high data rates. The added overhead is as follows:

Data rate	Overhead ratio (percentage)
64 kbps to < 768 kbps	19/17 (11.76%)
768 kbps to 1.5 Mbps	12/11 (9.09%)
> 1.5 Mbps to 2.5 Mbps	29/27 (7.4%)
> 2.5 Mbps to 7 Mbps	19/18 (5.56%)
> 7 Mbps	64/63 (1.58%)

Note that 64 kbps is the minimum data rate allowable with ESC++. Depending upon code rate and modulation used, the modem's maximum data rate of 25 Mbps may be used with ESC++. In all cases, if the Reed-Solomon outer codec is used, the 126/112 ratio is employed with ESC++. The new frame structure may be used with any FEC codec type available with the CDM-625A.

J.3 Available Baud Rates

At the lowest data rates, the 11.76% overhead may not allow all baud rates. Available rates are as follows:

Data rate	Baud rates available
64 to 127.999 kbps	1200, 2400, 4800
128 to 191.999 kbps	1200 to 9600
192 to 255.999 kbps	1200 to 14400
256 to 383.999 kbps	1200 to 19200
384 to 511.999 kbps	1200 to 28800
512 kbps and above	1200 to 38400

J.4 Configuration



Chapter 6. FRONT PANEL OPERATION

Use the **SELECT: Configure → Mode** menu to select **ESC++**. Then, use the **SELECT: Configure → Misc → HiRateESC** menu select the baud rate and asynchronous character format.

J.5 Effect on Eb/No Performance

Because the increase in transmitted data rate will cause a decrease in the Eb/No performance – particularly at lower data rates where the percentage overhead is large – all of the published data concerning BER versus Eb/No needs to be modified according to the table that follows:

Data rate	Overhead ratio (percentage)	Eb/No degradation
64 kbps to < 768 kbps	19/17 (11.76%)	0.48 dB
768 kbps to 1.5 Mbps	12/11 (9.09%)	0.38 dB
> 1.5 Mbps to 2.5 Mbps	29/27 (7.4%)	0.31 dB
> 2.5 Mbps to 7 Mbps	19/18 (5.56%)	0.23 dB
> 7 Mbps	64/63 (1.58%)	0.07 dB

The degradation is simply $10 \times \log$ (Overhead ratio).

The Eb/No displayed by the modem (**SELECT: Monitor → RX-Params**) takes this into account in the value that is calculated.

Appendix K. ETHERNET NETWORK CONFIGURATION

K.1 Overview

The CDM-625A Advanced Satellite Modem's handling of Ethernet terrestrial traffic data differs depending on whether the optional IP Packet Processor is either **not installed** or **installed but disabled**; or when the optional IP Packet Processor is **installed and enabled**.



Appendix L. IP PACKET PROCESSOR OPTION

This appendix explains the CDM-625A's Ethernet interface and illustrates the functional differences between the available operating modes. Additional modes of operation are also explained.

K.2 CDM-625A Ethernet Overview

K.2.1 Interface Architecture

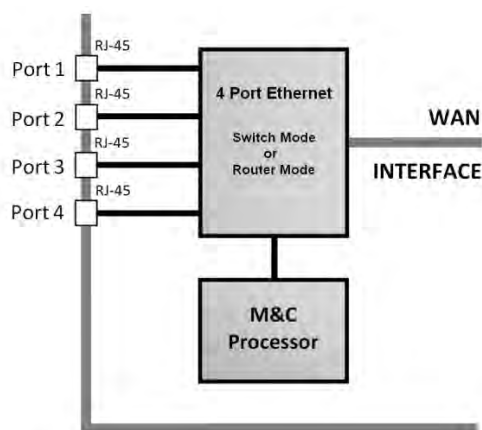

Figure K-1. CDM-625A Ethernet Architecture Design

Figure K-1 shows the internal Ethernet architecture for the CDM-625A. The CDM-625A features four built-in 10/100 BaseT Ethernet Ports (port configuration and statistics are available on a per-port basis) connected to a single internal Ethernet Layer 2 Managed Switch.

K.2.2 Modes of Ethernet Operation

The Ethernet interface is configurable for **Managed Switch Mode** when the optional IP Packet Processor is either *not installed* or *installed but disabled*; or in **Router Mode** or **Managed Switch Mode** when the optional IP Packet Processor is *installed* and *enabled*. This interface design allows for multiple customer Ethernet interfaces, as well as the convenience of daisy-chaining together of multiple CDM-625As.

Additionally, because the M&C processor is connected to the internal Ethernet Switch, M&C traffic is available via all LAN interfaces as well as via the over-the-air WAN interface.

K.2.3 Ethernet Networking Loops

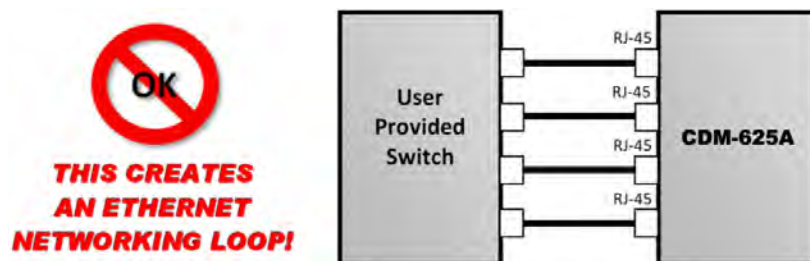

Figure K-2. Improper Use of External Ethernet Switch with CDM-625A

It should be noted that care must be taken to avoid **Ethernet Networking Loops**. Specifically, the network operator must make sure to avoid connecting multiple ports of the CDM-625A to the same external Ethernet switch, as shown in **Figure K-2**.

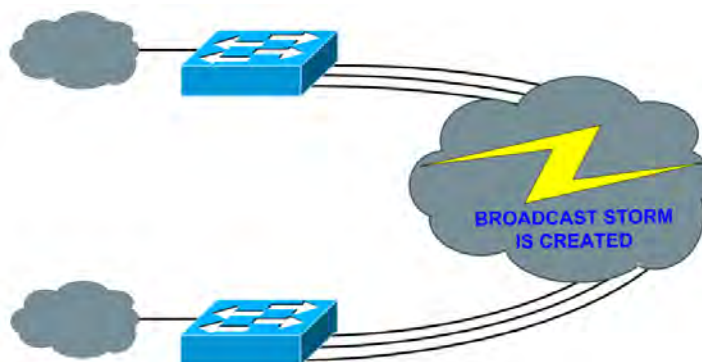

Figure K-3. Ethernet Networking Loop Example (Simplified)

Figure K-3 shows a simplified version of this loop. As shown here, two switches have been connected – each switch has two or more separate connections. This is *not* how the CDM-625A's Ethernet switches are designed to be used, and this configuration will cause a network outage.

K.2.3.1 Networking Loops in Managed Switch Mode

K.2.3.1.1 Hub-to-Hub Using Ethernet Switches

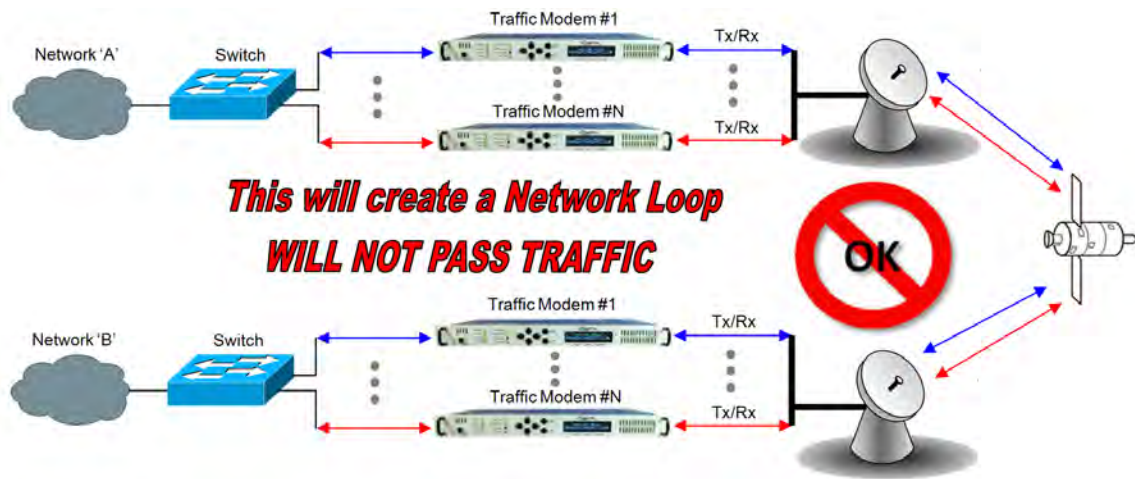

Figure K-4. Networking Loop Example

When connecting two or more “hub-sites” where there are multi-paths between each site, care must be taken to ensure that no Ethernet Networking Loops occur. **Figure K-4** shows two hub-sites connected with two or more modems, where all the traffic being transmitted and received is on the same LAN/VLAN. Since there is no router in the network and all the traffic is destined to the same network, an *Ethernet Networking Loop* has been created.

K.2.3.1.2 Hub-to-Hub Using Ethernet Routers

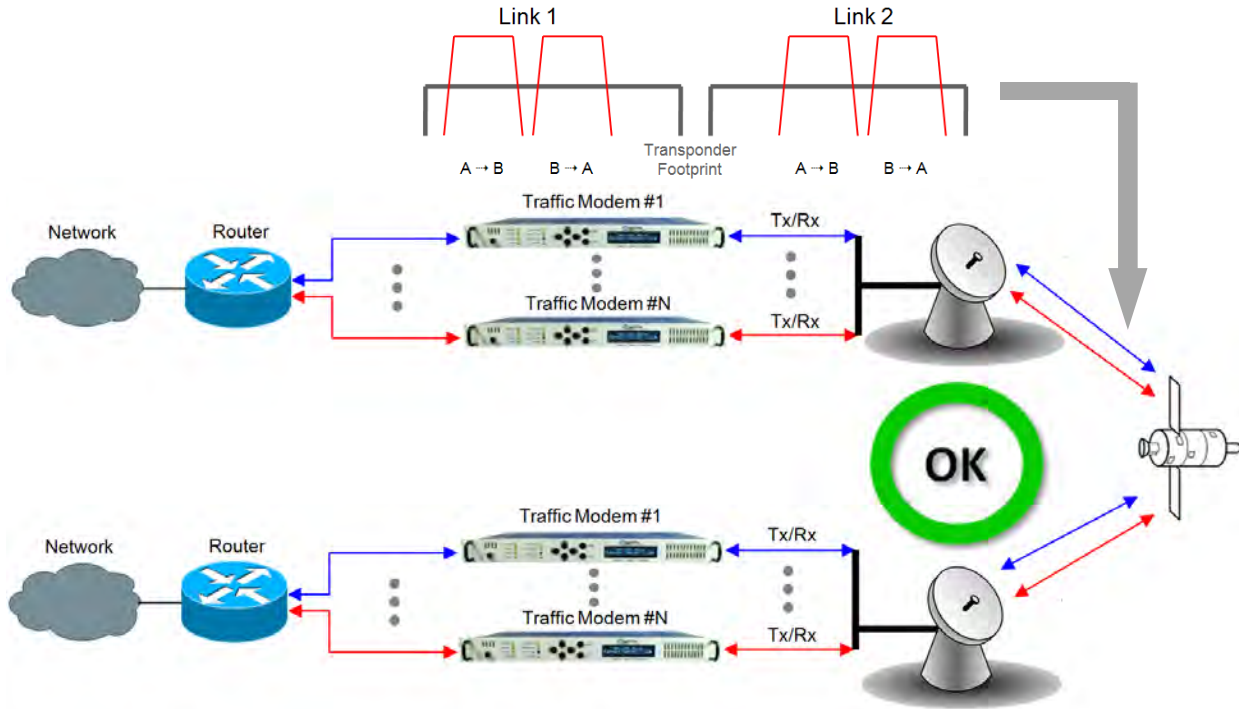

Figure K-5. Hub-to-Hub with Standard Traffic Using Routers

Figure K-5 shows two hub-sites connected with standard Ethernet traffic, using routers instead of switches for the Ethernet connection. The routers will block the broadcasts coming from the remote network; therefore, the creation of a broadcast storm is prevented and there is no possibility of having a remote MAC on the Hub networks.

K.2.3.1.3 Hub-to-Remotes Using Ethernet Switches or Routers

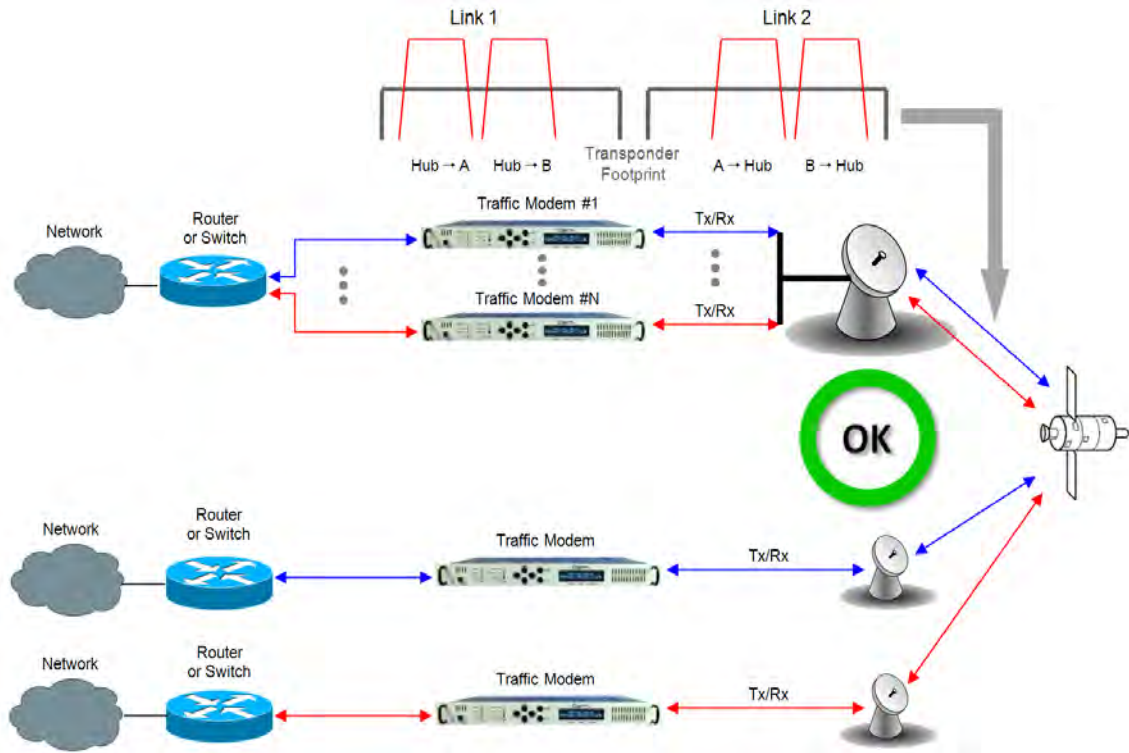

Figure K-6. Hub-to-Remotes with Standard Traffic Using Routers or Switches

Figure K-6 shows a hub-to-remotes configuration using switches or routers with standard Ethernet traffic, the routers/switches will block broadcasts coming from the hub and remote networks; therefore, the creation of a broadcast storm is prevented and there is no possibility of having a remote MAC on the Hub networks.

K.2.3.2 Networking Loops in Router Mode (with IP Packet Processor)

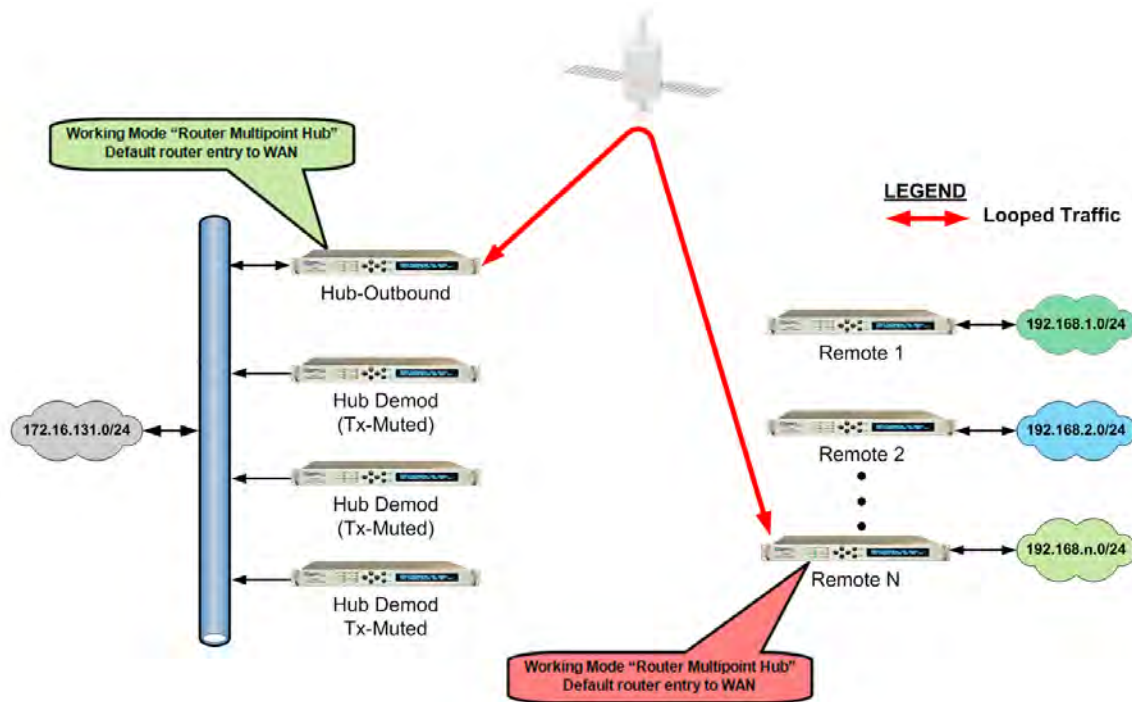

Figure K-7. Point-to-Point Configuration in "Router Multipoint Hub" Working Mode

In a network where more than one CDM-625A's working mode is set to "Router Multipoint Hub", care must be taken in route table configuration to avoid Ethernet Networking Loops. **Figure K-7** shows Point-to-Multipoint configuration using the optional IP Packet Processor.

When a CDM-625A's working mode is configured as "Router Multipoint Hub", the modem is allowed to *egress on* the WAN interface the same packet as was originally *ingressed from* the WAN interface. This is necessary to allow the Point-to-Multipoint configuration.

However, configuring more than one modem as a Router Hub across the WAN Interface, then adding default routes on either side – or any other invalid routes – will cause the same packet to ping-pong between these two modems until TTL times out.

K.3 Ethernet Network Configurations in Managed Switch Mode

K.3.1 Point-to-Multipoint Hub-to-Remotes, Split-path Traffic Using Routers

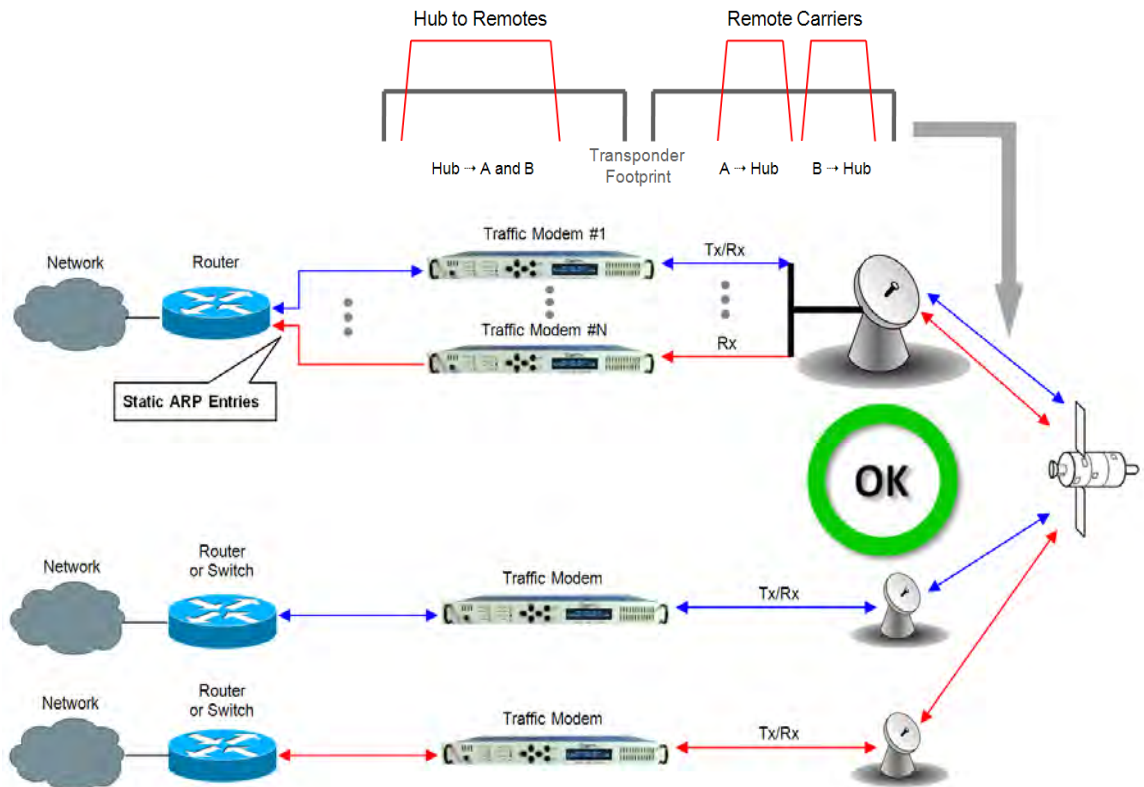

Figure K-8. Point-to-Multipoint Using Routers

Figure K-8 shows hub-to-remotes configuration using routers with standard and split-path Ethernet traffic. A Static ARP Entry is needed in the switch so that routing of the Tx side of the modems will be on the correct port of the router. **For example**, the Rx side of the Ethernet connection for ‘**Traffic Modem #N**’ comes in the bottom port of the Router, but the Tx Ethernet connection must be connected through the same port as ‘**Traffic Modem #1**’, as shown in this figure.

K.3.2 Point-to-Multipoint Hub-to-Remotes, Split-path Traffic Using Switches

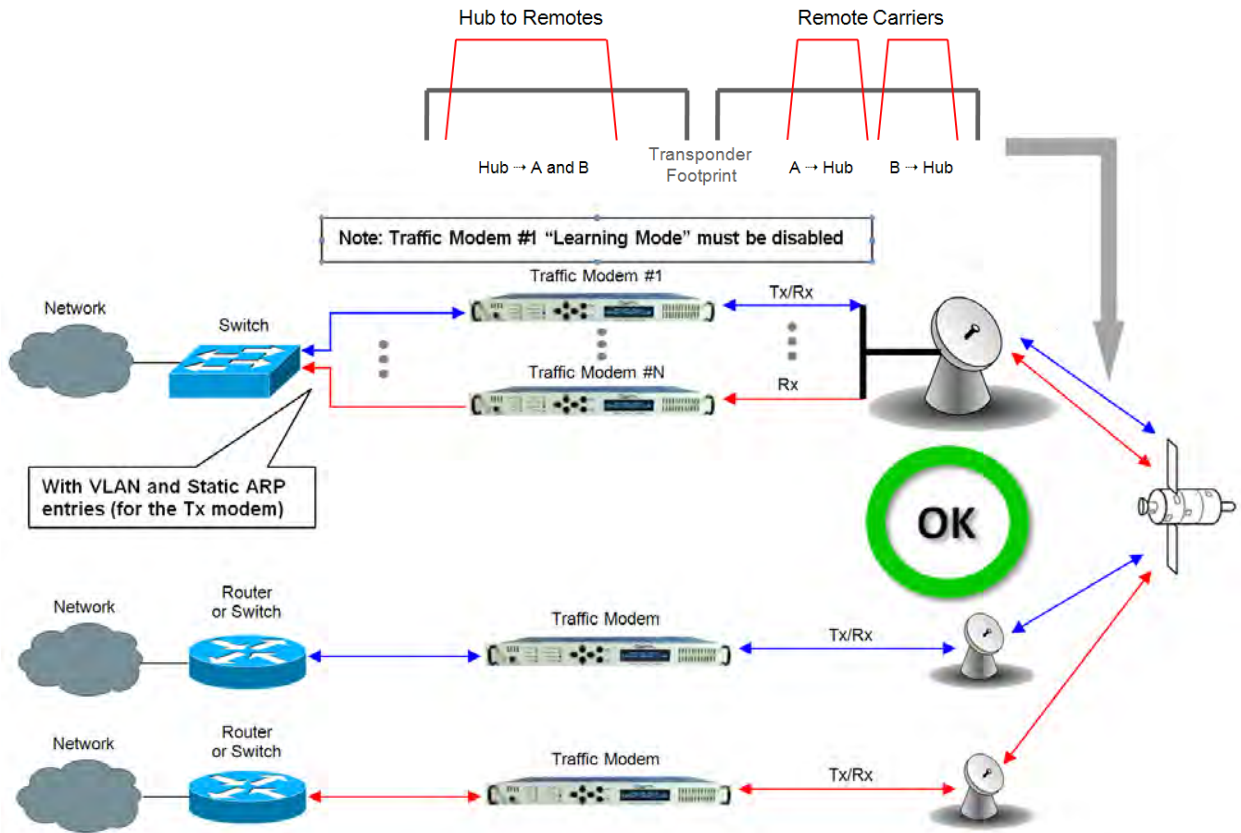

Figure K-9. Point-to-Multipoint Using Switches

With switches used, the hub and remote are on the same subnet as shown in **Figure K-9**, meaning that broadcasts will be allowed to transverse the network. Learning Mode must be disabled on the Hub Tx/Rx modem, because if a computer on the remote sends a broadcast out to the Hub, the modem learns that MAC is local – when, in fact, it is not.

K.4 Ethernet Network Configurations in Router Mode (with IP Packet Processor)

K.4.1 Point-to-Multipoint (Router Multipoint Hub) Mode

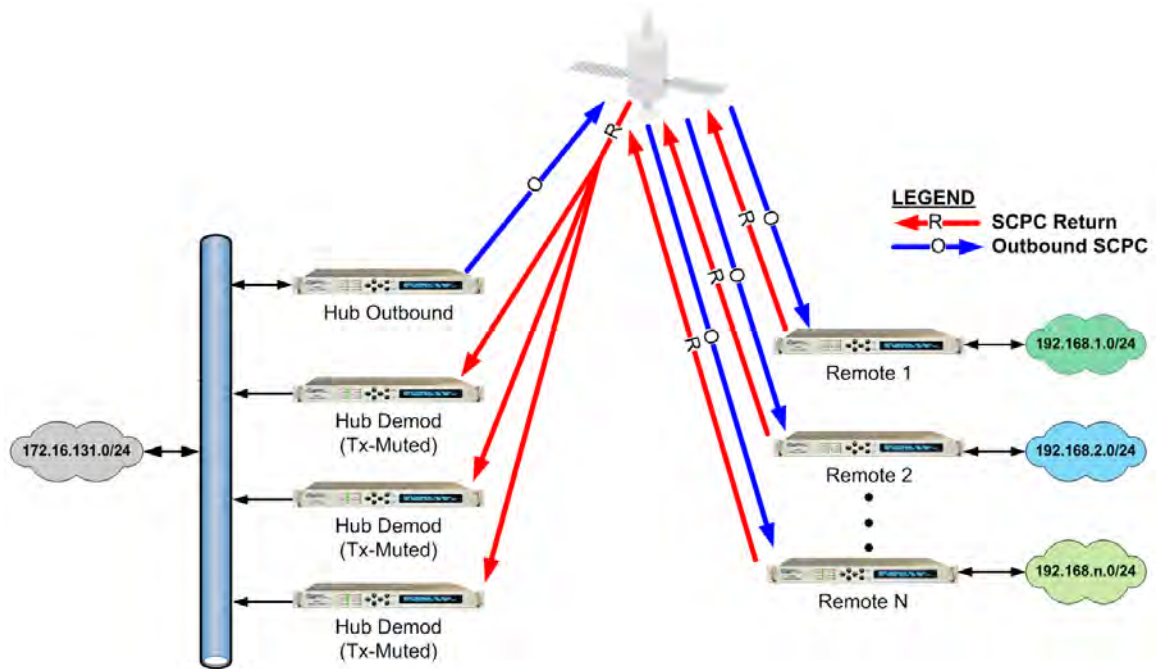

Figure K-10. Point-to-Multipoint (Router Multipoint Hub Mode)

Figure K-10 depicts a Point-to-Multipoint (Router Multipoint Hub) setup, with the optional IP Packet Processor *installed* and *enabled* in the CDM-625A and configured for Router Mode. This configuration features a Hub Outbound CDM-625A, with a rack of Hub Demods (Rx-only CDM-625As are connected on single LAN networks), and Remotes (each) connected to a separate LAN network).

K.4.1.1 Router Multipoint Hub Configuration

To configure a Router Multipoint Hub Network:

- **For the “Hub Outbound” Modem Configuration:**
 - Referring to **Sect. 7.5.4.3.2.1 Configuration | LAN | IP** in **Chapter 7. ETHERNET-BASED PRODUCT MANAGEMENT**: From the page’s **Network Configuration** section, use the **Working Mode** drop-down menu to select the mode as **Router Multipoint Hub**, and then click **[Submit]** to accept this configuration change.
 - Referring to **Sect. 7.5.4.3.3.1 Configuration | Routing | Routes** in **Chapter 7. ETHERNET-BASED PRODUCT MANAGEMENT**: From the page’s **Add New Route** section, add a route entry for each remote subset. Make sure to select **toWAN** from the **Interf.** drop-down menu (this defines the route as LAN → WAN). Click **[Add Entry]** once each route is created.

- **For the “Hub Demod” Modem Configurations:**
 - Referring to **Sect. 7.5.4.3.2.1 Configuration | LAN | IP** in **Chapter 7. ETHERNET-BASED PRODUCT MANAGEMENT**: From the page’s **Network Configuration** section, use the **Working Mode** drop-down menu to select the mode as **Router Multipoint Hub**, and then click **[Submit]** to accept this configuration change.
 - Referring to **Sect. 7.5.4.3.3.1 Configuration | Routing | Routes** in **Chapter 7. ETHERNET-BASED PRODUCT MANAGEMENT**: From the page’s **Add New Route** section, add a route for each remote subset. *First*, make sure to select **toLAN** from the **Interf.** drop-down menu (this defines the route as WAN → LAN); *then*, when assigning the **Next Hop IP** address, make sure it is identical to the *Hub Outbound modem’s IP address*.

Click **[Add Entry]** once each route is created.

- **For the “Remote” Modem Configurations:**
 - Referring to **Sect. 7.5.4.3.2.1 Configuration | LAN | IP** in **Chapter 7. ETHERNET-BASED PRODUCT MANAGEMENT**: From the **Network Configuration** section, use the **Working Mode** drop-down menu to select the mode as **Router Multipoint Remote**, and then click **[Submit]** to accept this configuration change.
 - Referring to **Sect. 7.5.4.3.3.1 Configuration | Routing | Routes** in **Chapter 7. ETHERNET-BASED PRODUCT MANAGEMENT**: Add a default LAN route entry using the page’s **Add New Route** section. *First*, specify the Hub Outbound modem’s IP address as the gateway address, *and then* select **toWAN** from the **Interf.** drop-down menu (this defines the route as LAN → WAN).

Click **[Add Entry]** once the route is created.

K.4.2 Multicast Routing Mode

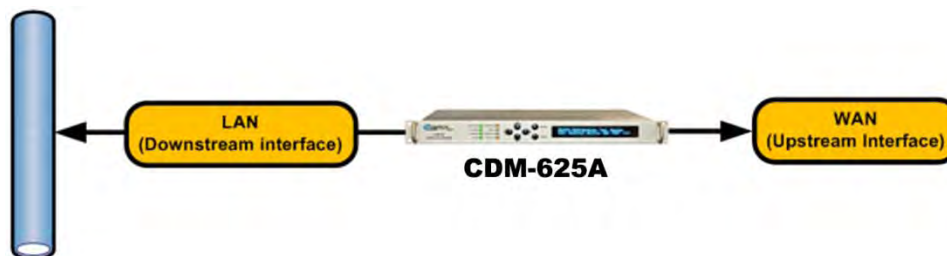

Figure K-11. Multicast Routing Diagram

Multicast Routing Mode, available when the optional IP Packet Processor is ***installed*** and ***enabled***, is where communications is established via one single source (referred to as the Multicast Sender) and routed to many groups of destination nodes (referred to as Multicast Receivers). Typical multicast applications include multimedia conferencing, online training, news, etc. **Figure K-11** depicts the schematic for a Multicast Routing Network.

As shown, there are two key components to this configuration – the **LAN Downstream Interface**, and the **WAN Upstream Interface**. Note the following:

- **LAN Downstream Interface** – the LAN Downstream Interface is the interface to which multicast packets arriving at the upstream interface are forwarded if a multicast group has at least one listener.



The CDM-625A LAN interfaces are configured as Downstream Interface and the IGMP server is enabled by default.

- **WAN Upstream Interface** – the WAN Upstream Interface is where all multicast packets are forwarded to the uplink interface if the multicast routing exists in the Routing table.



The CDM-625A WAN interface is configured as Upstream Interface by default.

K.4.2.1 Multicast Routing Configuration

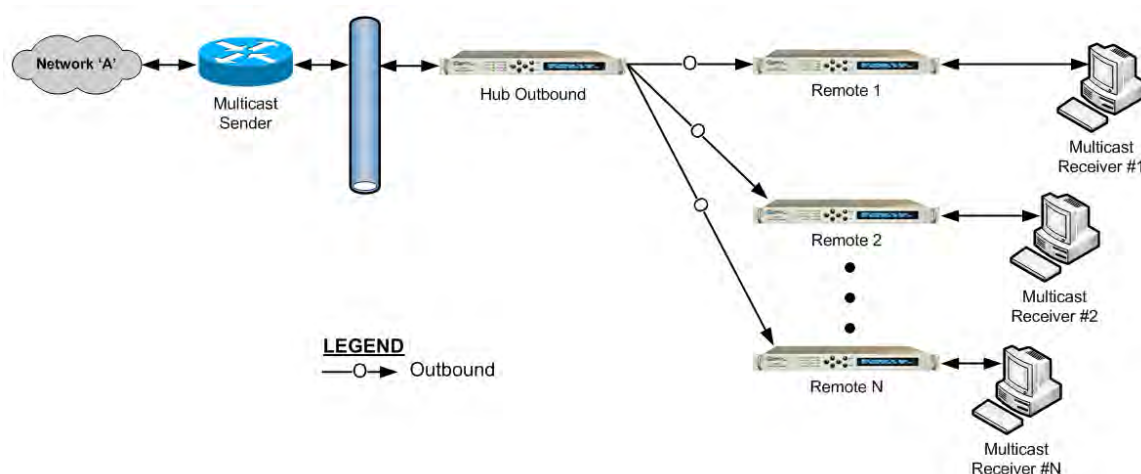

Figure K-12. Configuration Example for a Multicast Routing Network

To configure a Multicast Routing Network (Figure K-12):

- **For “Hub Outbound” Modem Configuration** – Referring to **Sect. 7.5.4.3.3.1 Configuration | Routing | Routes** in **Chapter 7. ETHERNET-BASED PRODUCT MANAGEMENT**: Add a multicast route (using the page’s **Add New Route** section), making sure to select **toWAN** from the **Interf.** drop-down menu (this defines the route as LAN → WAN). Click **[Add Entry]** once the route is created.
- **For “Remote” Modem Configuration** – Referring to **Section 7.5.4.3.3.2 Configuration | Routing | IGMP** in **Chapter 7. ETHERNET-BASED PRODUCT MANAGEMENT**: From the page’s **IGMP Multicast Router** section, edit the IGMP parameters to suit the multicast receivers’ capabilities (i.e., version number and query intervals).

K.5 Ethernet Overhead over WAN Interface

K.5.1 Managed Switch Mode (without IP Packet Processor)

When the optional IP Packet Processor is either *not installed* or *installed but disabled*: After Ethernet packets are sent from the internal switch to the modem WAN interface, the link overhead per packet is as follows:

1 Byte (HDLC Start Flag) + 2 Bytes HDLC Control + 14 Bytes Ethernet Header + Ethernet Payload + 2 Bytes HDLC CRC

Additionally, on average, an additional 3% of overhead is added to account for HDLC bit stuffing.

K.5.2 Router Mode or Managed Switch Mode (with IP Packet Processor)

When the optional IP Packet Processor is *installed* and *enabled*: The CDM-625A uses Comtech EF Data's patented Streamline Encapsulation (SLE) Framing instead of HDLC Framing.

Note that in SLE Framing, no bit stuffing overhead is involved; hence, WAN overhead is deterministic. After Ethernet packets are sent from the internal switch to the IP Packet Processor interface, per packet overhead on the WAN Interface is as follows:

1 Byte SLE start Flags + Control Byte(s)+ Ethernet Payload (IP + UDP + payload; IP + TCP + payload; etc.) + 2 bytes CRC

For Control Byte (s) note the following:

- If payload compression or header compression or both are enabled, **Control Byte (s) = 2 bytes;**
- If Segmentation and Reassembly (SAR) is enabled, **Control Byte (s) = 2 bytes;**
- Otherwise, **Control Byte (s) = 1 byte.**

K.6 Ethernet Redundancy

Once you have determined the best configuration for near-to-far end Ethernet networks, you may add the appropriate redundancy switches to one or both ends of the link(s):

- **1:1 Redundancy** is supported using either a CRS-170A L-Band 1:1 Redundancy Switch or a CRS-180 70/140 MHz 1:1 Redundancy Switch, and a user-provided, off-the-shelf Ethernet switch.
- **1:N Redundancy** is supported using a CRS-300 1:10 Redundancy Switch or a CRS-500 M:N Redundancy System in 1:N mode (in a **wired-thru** or **wired-around** configuration), and is supported in Single-Port Ethernet Bridge (Managed Switch) and Router Modes (the optional IP Packet Processor is required for Router Mode).
- **Packet Processor Redundancy** is supported in both 1:1 and 1:N redundant configurations using the CRS-500 M:N Redundancy System.

Refer to the pertinent switch Installation and Operation Manuals for detailed information on using the CDM-625A in a redundancy configuration.

K.7 Advanced Network Timing

K.7.1 Overview

The Advanced Network Timing (ANT) feature provides IP-based protocols to synchronize the modem's internal time-of-day clock to an external device such as a time server, Base Station Controller (BSC), or Radio Network Controller (RNC).

K.7.2 SNTP (Simple Network Time Protocol)

The **Simple Network Time Protocol (SNTP)**, defined in RFC-1361, provides millisecond-resolution time synchronization with a time server. When the modem synchronizes its time, it also synchronizes the time of all connected EDMAC devices, such as slave LPODs or CSATs. When all devices are synchronized, administrators can better correlate logged events between devices.

SNTP is a UDP protocol that works on port 123. If the modem is not updating its time, verify that there are no network devices between the modem and time server that might block UDP packets on that port.

K.7.3 PTP (Precision Time Protocol)



For better PTP clock accuracy, ingress and egress port sync interval should be at least 2 seconds.

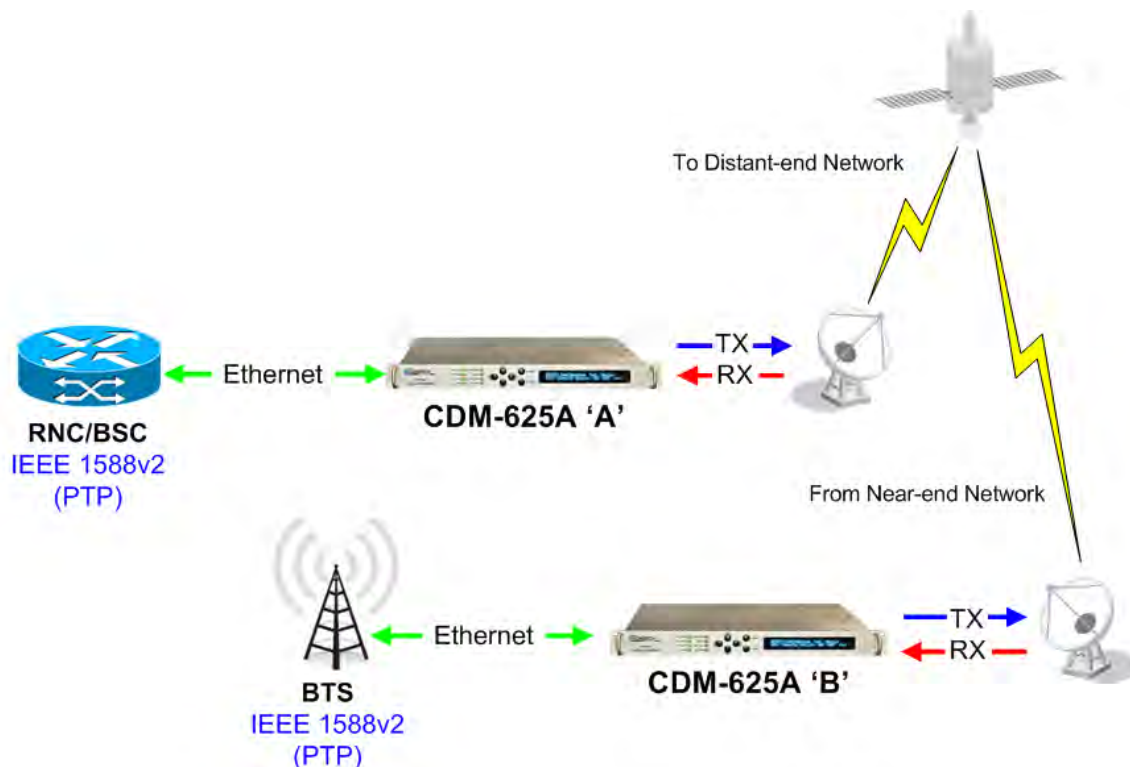

Figure K-13. Configuration Example – Point-to-Point Network with PTP

The **Precision Time Protocol** is used to synchronize clocks throughout a computer network. Based on the IEEE 1588v2 (2008) standard, PTP achieves clock accuracy in the nanosecond range – much more accurate than what is attainable by NTP (Network Time Protocol) – and it is also used in network applications where GPS is either unaffordable or inaccessible.

Figure K-13 shows a typical network configuration. Here, the RNC/BSC (Radio Network Controller/Base Station Controller) at the near-end side of the network and the BTS (Base Transceiver Station) on the distant-end side of the network are the IEEE 1588v2-capable devices. In this topology the RNC/BSC serves as the Grandmaster – the root timing reference that transmits synchronization information to the clocks residing on its network segment – or slave to the Grandmaster.

Comtech EF Data's implementation of PTP in the CDM-625A operates over IP, without the presence of the optional IP Packet Processor. To achieve high accuracy time and frequency synchronization, PTP relies on hardware time stamping at the ingress and egress ports of the network; therefore, all devices in the network must support PTP.

Without PTP implementation and support in the modem, it is very difficult to achieve PTP end-to-end (RNC ► BTS) time synchronization in nanosecond range due to the presence in the network of variable delay components such as QoS (Quality of Service) buffer, Rx/Tx FIFOs, Satellite Doppler, etc.

The CDM-625A bridges PTP from LAN to WAN and vice versa, and uses 2-step synchronization (i.e., it sends both Sync and Follow-up messages when acting as a master). When negotiating with devices over the LAN interface, the modem uses UDP multicast PTP messages on UDP Port 319 for events, and UDP Port 320 for general packets. On the WAN interface, the modem uses UDP Port 59319 for events, and UDP Port 59320 for general packets.

Some devices use the Announce message to negotiate which is the PTP master, a process known as the Best Master Clock (BMC) algorithm. This algorithm allows PTP devices to vote on which device has the best clock resolution. The CDM-625A will become a PTP master if there is no Grandmaster device or the Grandmaster is not reachable.

You must configure the modem for the Grandmaster location:

- When the modem can reach the Grandmaster device only through its LAN interface, set Grandmaster to **LAN**.

When Grandmaster is **LAN**, then the modem knows it must become a slave to the Grandmaster on the LAN interface, and will set its PTP Clock Priority1 value to 255 (the lowest).

- When the modem must synchronize with the Grandmaster over the WAN interface, set Grandmaster to **WAN**.

When Grandmaster is **WAN**, the modem will set its PTP Clock Priority1 value to 1 (the highest) to force slave devices that use the BMC algorithm to accept the modem as the PTP master.

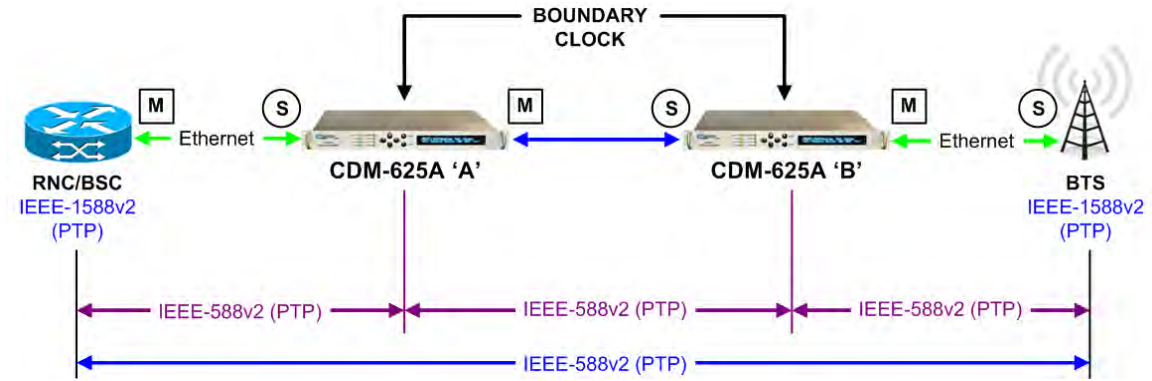

Symbol	Designation	Function
M	Master	The Master device maintains the clocks.
S	Slave	The Slave device synchronizes its clock to the Master device's clock.

Figure K-14. PTP Master/Slave Assignment Example

As shown in **Figure K-14**:

- The first segment is between the RNC/BSC and the CDM-625A 'A' (near-end modem) LAN port. In this segment, the RNC/BSC is the **master**, and the near-end modem LAN port is the **slave**.

Using the **CDM-625A 'A'** front panel or its Web Server Interface, set the **PTP Grandmaster** on this near-end modem as **LAN**.

- The second segment is from the CDM-625A 'A' (near-end modem) WAN port to the CDM-625A 'B' (distant-end modem) WAN port, in which the near-end modem WAN port is the **master** and the distant-end modem WAN port is the **slave**.

Using the **CDM-625A 'B'** front panel or its Web Server Interface, set the **PTP Grandmaster** on this distant-end modem as **WAN**.

Accordingly, the third segment between the **CDM-625A 'B'** (distant-end modem) LAN port and the BTS defines the distant-end modem's LAN port as the **master** and the BTS as the **slave**.

As configured here, each modem has established independent Wireless Receiver/Transmitter (WRT) protocol segments – one for LAN and other one for WAN. This defines the boundary clock time distribution configuration, where the slave to one interface provides a master clock to the other interfaces.

Appendix L. IP PACKET PROCESSOR OPTION

L.1 Overview

The IP Packet Processor is an optional feature for the CDM-625A Advanced Satellite Modem. In addition to providing Layer 3 functionality, it incorporates a number of key features for Wide Area Network (WAN) bandwidth optimization. This includes very low overhead Streamline Encapsulation (SLE), Header Compression, Payload Compression, Advanced Quality of Service (QoS), and Advanced Encryption Standard (AES) Encryption.

The IP Packet Processor enables efficient IP networking and transport over satellite either in Router Mode or Managed Switch Mode. The combination of Advanced QoS with Header and Payload Compression ensures the highest quality of service with minimal jitter and latency for real-time traffic, priority treatment of mission critical applications, and maximum bandwidth efficiency.

L.1.1 Operational Requirements



The IP Packet Processor is available as a factory-installed option or, depending on its originally shipped configuration, as a field-upgradeable option. Use of the IP Packet Processor with the CDM-625A Advanced Satellite Modem requires the following:

CDM-625A Power Requirements for the IP Packet Processor Board (CEFD P/N PL-0000481) – When ordering the IP Packet Processor as a factory installed option, the modem power supply that is specified at the time of order must be 175 watts for AC units, or 125 watts for DC units.

Existing field units that meet either power supply configuration requirement are user-upgradable in the field using CEFD Kit KT-0000176 – refer to Section L.5 in this appendix for the field upgrade procedure using this kit.

However, existing field units that do not meet these power supply configuration requirements – i.e., units that are configured with 65W AC or 65W DC power supplies – must be returned either to Comtech EF Data or sent to a Comtech EF Data Authorized Service Center for upgrade using CEFD Kit KT-0000174 (for 65W AC units) or CEFD Kit KT-0000175 (for 65W DC units).

L.1.2 CDM-625A → CDM-625A Interoperability Compatibility/Limitations



A CDM-625A Advanced Satellite Modem that is equipped with the IP Packet Processor is not interoperable for IP/Ethernet Traffic with a CDM-625A that is not equipped with the IP Packet Processor.

L.2 IP Packet Processor Features

L.2.1 Streamline Encapsulation (SLE)

SLE can reduce the encapsulation overhead by as much as 65% compared to industry-standard HDLC.

L.2.2 Modes of Operation



Appendix K. ETHERNET NETWORK CONFIGURATION

A CDM-625A equipped with the IP Packet Processor can operate in four modes to support Point-to-Point and Point-to-Multipoint network topologies:

- Router Point-to-Point
- Router Remote
- Router Hub
- Managed Switch

L.2.3 Adaptive Coding and Modulation (ACM)



Appendix M. ADAPTIVE CODING AND MODULATION (ACM)

Comtech EF Data's VersaFEC[®] Adaptive Coding and Modulation (ACM) feature, a patents-pending technology wholly owned and developed by Comtech EF Data and CEFD sister division Comtech AHA Enterprise Products Group, can be used with the IP Packet Processor to maximize throughput.

ACM converts available link margin into additional throughput, thereby maximizing throughput under all conditions, including rain fade, inclined orbit satellite operation, antenna mispointing, interference and other impairments.

L.2.4 Subsystem Multiplex (Sub-Mux)



Appendix N. IP SUB-MUX

Sub-Mux is a secondary framing structure that combines IP traffic with any currently available combination of framing and interface type (excluding IP itself). A specific, user-selected ratio

references the composite data rate to the modulator, and from the demodulator to the primary, non-IP interface rate.

Sub-Mux capability can be used with the IP Packet Processor to multiplex a primary serial synchronous or G.703 traffic stream with IP.

L.2.5 FAST Options



- **Chapter 5. FAST ACTIVATION PROCEDURE**
- **Sect. 6.2.8 SELECT: FAST Menus (Chapter 6. FRONT PANEL OPERATION)**

If there is a need to upgrade the CDM-625A IP Packet Processor's functionality, Comtech EF Data provides **Fully Accessible System Topology (FAST)**, a technology that permits the purchase and installation of options through special authorization codes. These unique Fast Access Codes may be purchased from Comtech EF Data during normal business hours, and then loaded into the unit using the front panel keypad.

Contact Comtech EF Data Product Support to acquire the following available **FAST** options:

- **Quality of Service (QoS)**
- **AES Encryption**
- **Header Compression:**
 - Up to 5 Mbps (CCM) / 1200 ksps (ACM)
 - Up to 10 Mbps (CCM) / 4100 ksps (ACM)
 - Up to 15 Mbps (CCM) / 4100 ksps (ACM)
 - Up to 20 Mbps (CCM) / 4100 ksps (ACM)
 - Up to 25 Mbps (CCM) / 4100 ksps (ACM)
- **Payload Compression:**
 - Up to 5 Mbps (CCM) / 1200 ksps (ACM)
 - Up to 10 Mbps (CCM) / 4100 ksps (ACM)
 - Up to 15 Mbps (CCM) / 4100 ksps (ACM)
 - Up to 20 Mbps (CCM) / 4100 ksps (ACM)
 - Up to 25 Mbps (CCM) / 4100 ksps (ACM)

L.2.5.1 Advanced Quality of Service (QoS)

The IP Packet Processor incorporates multi-level QoS to ensure the highest quality of service with minimal jitter and latency for real-time traffic, priority treatment of mission critical applications and maximum bandwidth efficiency.

The supported modes of QoS are:

- **DiffServ** – Industry-standard method of providing QoS, enabling seamless co-existence in networks that implement DiffServ
- **Max/Priority** – Provides multi-level traffic prioritization with the ability to limit maximum traffic per priority class

- **Min/Max** – Provides a Committed Information Rate (CIR) to each user-defined class of traffic with the ability to allow a higher burstable rate depending on availability
- When using rule-based QoS, you can configure up to 32 different rules based on:

- Source IP address and subnet mask
- Destination IP address and subnet mask
- Source Port
- Destination Port
- Protocols (well known)
- Priority

L.2.5.2 Advanced Encryption Standard (AES) Encryption



Chapter 7. ETHERNET-BASED REMOTE PRODUCT MANAGEMENT:

- Sect. 7.5.4.3.3.1 Configuration | Routing | Routes
- Sect. 7.5.4.3.4 Configuration | Managed Switch
- Sect. 7.5.4.3.5.3 Configuration | WAN | Encryption

When the AES Encryption option is active and enabled on a WAN route, the IP Packet Processor will encrypt all outgoing traffic on the WAN, and decrypt any encrypted traffic it receives.

L.2.5.3 Header Compression

The IP Packet Processor incorporates industry-leading header compression for IP traffic. Header compression can reduce the 40-byte IP/UDP/RTP header to as little as 1 byte; for TCP/IP, the 40-byte header is reduced to as little as 3 bytes.

For applications such as Voice-over-IP (VoIP), header compression can provide bandwidth savings exceeding 60%. **For example**, the 8 kbps G.729 voice codec requires 24 kbps of IP bandwidth once encapsulated into an IP/UDP/RTP datagram. With header compression, the same voice call needs about 8.5 kbps – a saving of almost 65%.

In addition, bandwidth requirements for typical Web/HTTP traffic can be reduced by 10% or more with TCP/IP header compression.

L.2.5.4 Payload Compression

The IP Packet Processor features industry-leading payload compression for IP traffic. Implemented in the hardware for maximum throughput and efficiency, payload compression can reduce the required satellite bandwidth by as much as 40–50%.

L.3 CDM-625A Operation with IP Packet Processor

Functionality and selection of the IP Packet Processor's features and modes of operation, as specified in the previous section, is seamless via the CDM-625A's operational interfaces. Equipment monitor and control (M&C) is possible via the methods outlined in this section.

L.3.1 Front Panel Operation



Chapter 6. FRONT PANEL OPERATION



Using the keypad on the front panel, you may access a variety of nested menus to configure the options available whenever the CDM-625A is equipped with the IP Packet Processor.

L.3.2 Ethernet-based Remote Product Management

The CDM-625A 10/100 BaseT Ethernet Management Interface supports three management protocols for remote monitor and control (M&C) of the modem:

- **Simple Network Management Protocol (SNMP)** – This requires a user-supplied Network Management System (NMS) and a user-supplied Management Information Base (MIB) File Browser.
- **Telnet Interface** – This requires use of a user-supplied terminal emulation program such as HyperTerminal (for use with the remote control protocol) or PuTTY (for use with the Telnet Command Line Interface), installed on the user PC.
- **CDM-625A HTTP (Web Server) Interface** – This requires a compatible user-supplied web browser such as Internet Explorer.

L.3.2.1 SNMP Interface



Sect. 7.3 SNMP Interface (Chapter 7. ETHERNET-BASED REMOTE PRODUCT MANAGEMENT)

The *Simple Network Management Protocol* (SNMP) is an Internet-standard protocol for managing devices on IP networks. An SNMP-managed network consists of three key components:

- **The managed device** – This includes the CDM-625A Advanced Satellite Modem.
- **The SNMP Agent** – The software that runs on the CDM-625A. The CDM-625A SNMP Agent supports both **SNMPv1** and **SNMPv2c**.
- **The user-supplied Network Management System (NMS)** – The software that runs on the manager.

L.3.2.2 Telnet Interface



- Sect. 7.4 Telnet Interface (Chapter 7. ETHERNET-BASED REMOTE PRODUCT MANAGEMENT)
- Chapter 8. SERIAL-BASED REMOTE PRODUCT MANAGEMENT
- Chapter 9. TELNET COMMAND LINE INTERFACE (CLI) OPERATION

Comtech EF Data provides a Telnet interface for the purpose of equipment monitor and control (M&C) using either the standard remote control protocol or, when the optional IP Packet Processor is **installed** and **enabled**, the Telnet Command Line Interface (CLI) (Figure L-1).

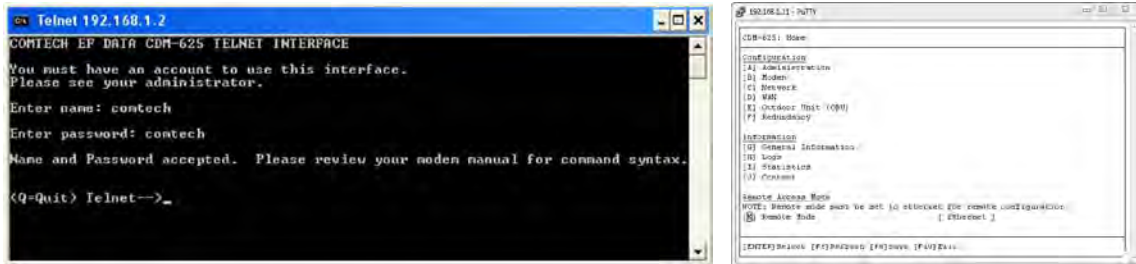

Figure L-1. CDM-625A Telnet Interfaces Interfaces (Serial Remote / CLI)

L.3.2.3 HTTP (Web Server) Interface



- Sect. 7.5 HTTP (Web Server) Interface (Chapter 7. ETHERNET-BASED REMOTE PRODUCT MANAGEMENT)

The embedded HTTP (Web Server) application (Figure L-2) provides an easy to use interface designed for optimal performance when using Microsoft's Internet Explorer Version 9.0 or higher. The interface features enhanced functionality when the CDM-625A is equipped with the IP Packet Processor.



Figure L-2. CDM-625A HTTP (Web Server) Interface Home Page

L.4 List of Supported Internet RFCs (Requests for Comment)

RFC No.	Description
768	User Datagram Protocol
791	Internet Protocol
793	Transmission Control Protocol
826	Ethernet Address Resolution Protocol
894	A Standard for the Transmission of IP Datagrams over Ethernet Networks
919	Broadcasting Internet Datagrams
922	Broadcasting Internet Datagrams in the Presence of Subnets
950	Internet Standard Subnetting Procedure
951	Bootstrap Protocol (BOOTP)
959	File Transfer Protocol
1071	Computing the Internet Checksum
1112	Host Extensions for IP Multicasting
1350	The TFTP Protocol
1700	Assigned Numbers
2236	Internet Group Management Protocol, Volume 2
2474	Definition of the Differentiated Services Field (DS Field) in the IPv4 and IPv6 Headers
2475	An Architecture for Differentiated Services
2597	Assured Forwarding PHB
2598	An Expedited Forwarding PHB
2933	Internet Group Management Protocol MIB
3376	Internet Group Management Protocol, Volume 3
4293	Management Information Base for the Internet Protocol (IP)

L.5 IP Packet Processor Field Upgrade Procedure

L.5.1 Overview

This section describes the field upgrade procedure you will need to follow to retrofit your CDM-625A-Advanced Satellite Modem, having a 175W AC or 125W DC Power Supply, with the optional IP Packet Processor card. See Sections L.1.1 and L.1.2 in this appendix for a detailed description of the requirements and limitations of using the IP Packet Processor with the CDM-625A.

L.5.2 Requirements for Field Upgrade

- CDM-625A Advanced Satellite Modem with 175W AC or 125W DC Power Supply
- Medium Phillips™ screwdriver
- Needle-nose pliers
- CEFD P/N KT-0000176 IP Packet Processor with Fan Upgrade Kit, containing:

CEFD Part Number	QTY	Description
PL-0000449	1	Fan Assembly, 40 x 40 x 10
FN/FGDC12V01	1	Fan Guard
HW/4-40X3/4PH	4	Screw, S.S., 4-40 x 3/4 LG, Pan Head Phillips
HW/440HXNUTLOC	4	Elastic Locking Hex Nut, S.S., 4-40
PL-0000481	1	CDM-625A IP Packet Processor Card
HW/SEM440X1/4PH	2	Screw, S.S., 4-40 x 1/4 LG, Pan Head Phillips

L.5.3 Field Upgrade Procedure

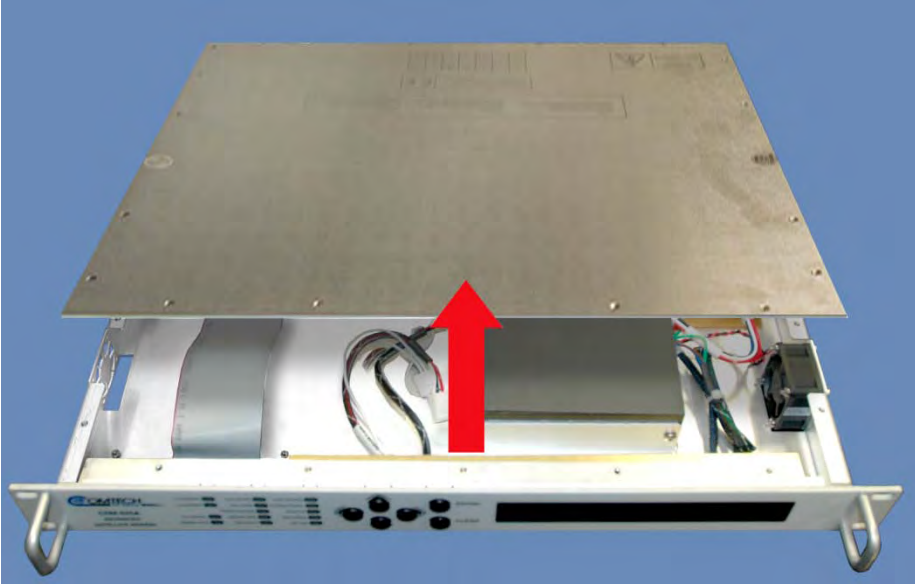
Step	Task	
1	<p>Turn off the CDM-625A and disconnect the modem's power cord from its power source.</p> <p>Next, use the screwdriver to remove the top cover mounting hardware. Remove the cover from the CDM-625A chassis.</p> <p>IMPORTANT: Be sure to retain the top cover mounting hardware for cover re-installation once you have installed the IP Packet Processor Card and its cooling fan.</p>	

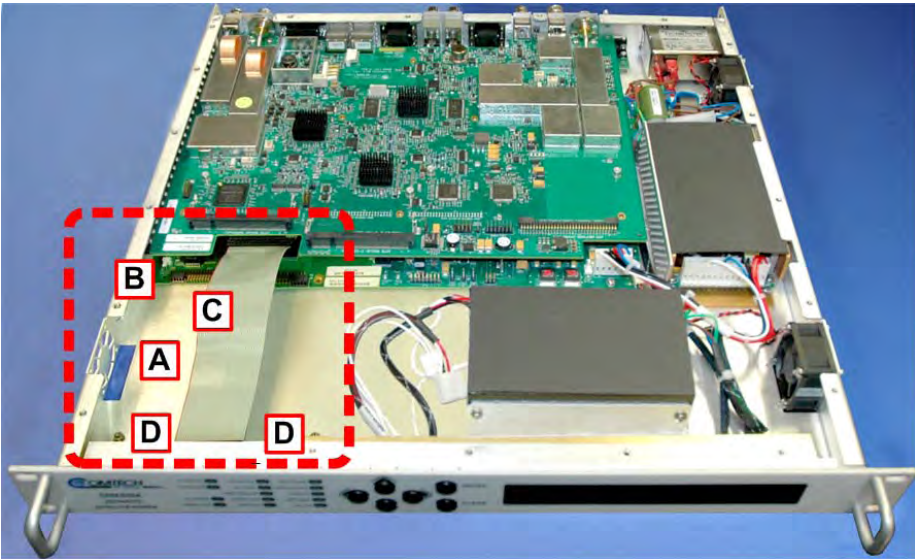
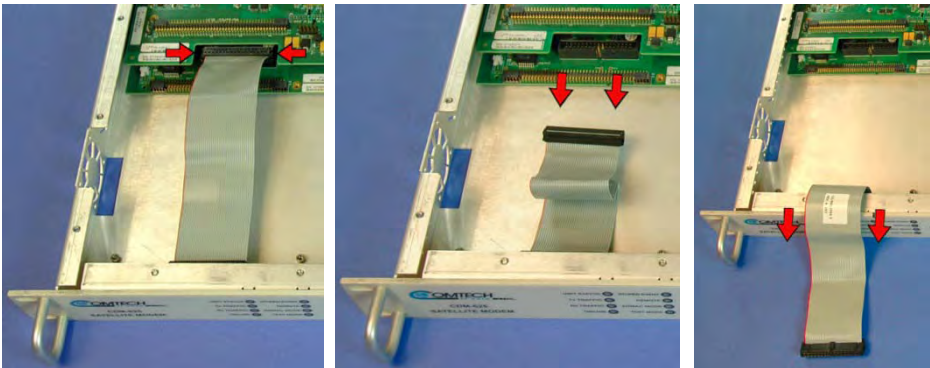
Step	Task	
2	<p>The illustration at right identifies the upgrade locations within the chassis for:</p> <ul style="list-style-type: none"> • Installation of the fan into the chassis (A); • Plug-in of both the fan power cable (B) and IP Packet Processor Card (C) into the modem's framing board; • Assembly of the IP Packet Processor Card onto the chassis-mounted card bosses (D). 	
3	<p>Unplug the front panel ribbon cable from its connector on the modem's framing board, and then move the cable out of the way of the upgrade location (CDM-625 chassis shown).</p>	

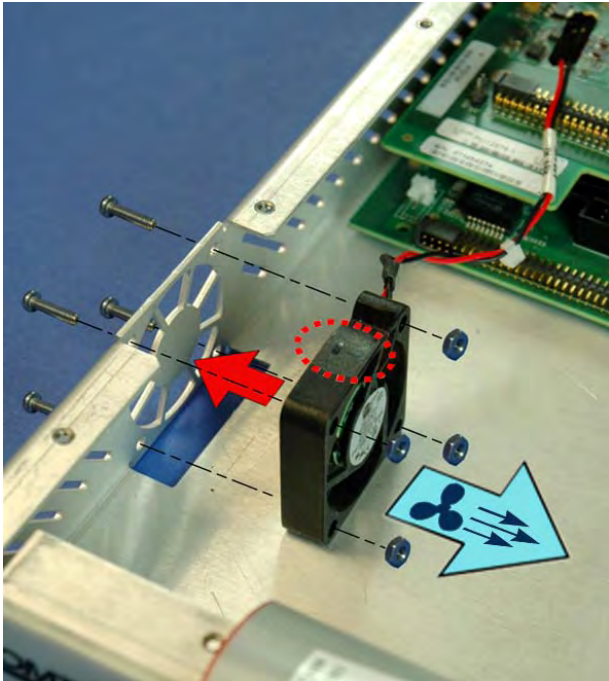
Step	Task	
4	<p>Use the screwdriver and pliers, as needed, to install the fan (CEFD P/N PL-0000449) and fan guard (CEFD P/N FN/FGDC12V01) securely into the chassis with the provided mounting hardware (4X CEFD P/N HW/4-40X3/4PH 4-40 x 3/4 pan head screws <i>and</i> 4X CEFD P/N HW/440HXNUTLOC 4-40 locking hex nuts) at the designated location.</p> <p>IMPORTANT NOTE: Refer to the arrow icons imprinted on the fan housing when installing the fan, to ensure that:</p> <ul style="list-style-type: none">• The air flow is directed into the chassis during operation <i>and</i>• The fan power cable is routed towards the power connector on the modem's framing board.	

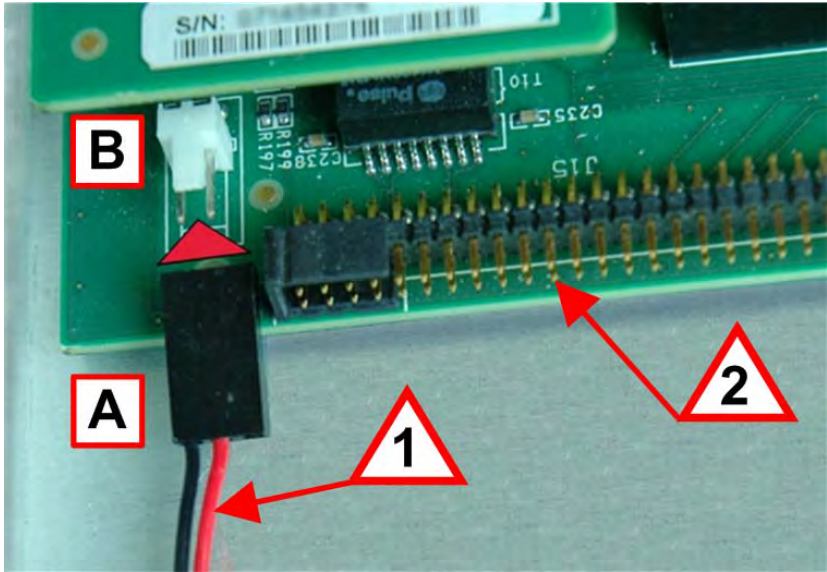
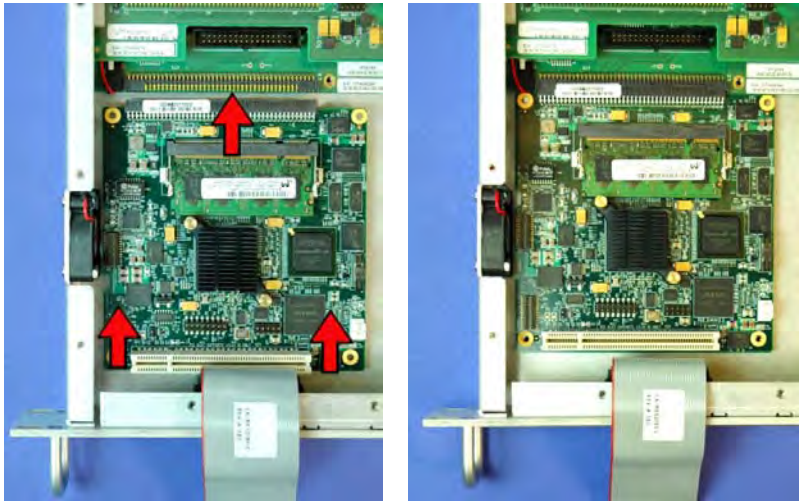
Step	Task	
5	<p>Use needle-nose pliers as needed to plug the fan power cable receptacle (A) into the mating connector on the modem's framing board (B).</p> <p>IMPORTANT NOTE 1: Note the orientation of the fan's power cable receptacle and wiring to the mating connector and its pins on the modem's framing board.</p> <p>IMPORTANT NOTE 2: Take care not to damage the pins for the mating connector to the PL-0000481 IP Packet Processor Card.</p>	
6	<p>Prepare the IP Packet Processor Card for installation by aligning its receptacle with the mating connector on the modem's framing board.</p> <p>Plug the card firmly into the connector – take care not to damage any top-mounted components. Similarly, be sure not to damage the bottom of the card on the chassis' mounting bosses while plugging the card receptacle into its mating connector.</p> <p>Installation is complete once the cable connector is fully engaged within its mating receptacle, and the mounting holes at the front of the card are aligned with the mounting boss threaded holes.</p>	

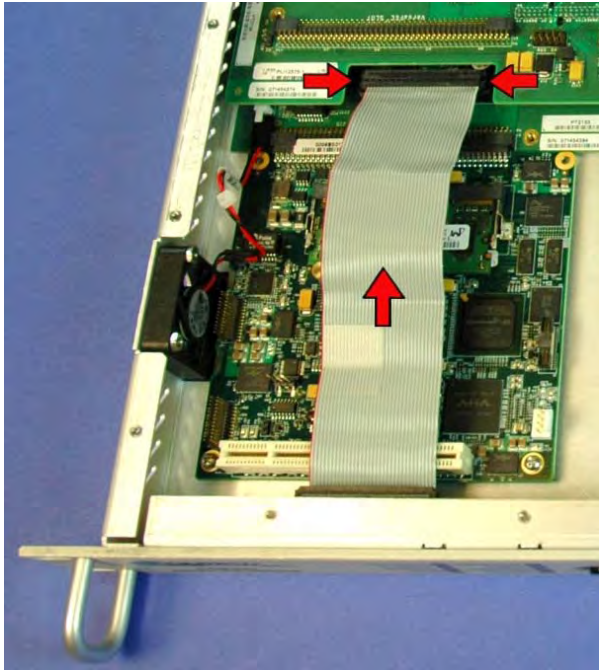
Step	Task	
7	Use the screwdriver to secure the IP Packet Processor card to the chassis with its provided mounting hardware (2X 4-40 x 1/4 pan head screws).	 A close-up photograph of the IP Packet Processor card. The card is green with various components. Two circular mounting holes are circled in red, indicating where the screws should be inserted. A white ribbon cable connector is visible at the bottom of the card.
8	Plug the front panel ribbon cable back into its mating connector on the modem's framing board.	 A photograph showing the ribbon cable being inserted into the mating connector on the modem's framing board. Red arrows point to the cable and the connector, indicating the correct alignment and insertion point.

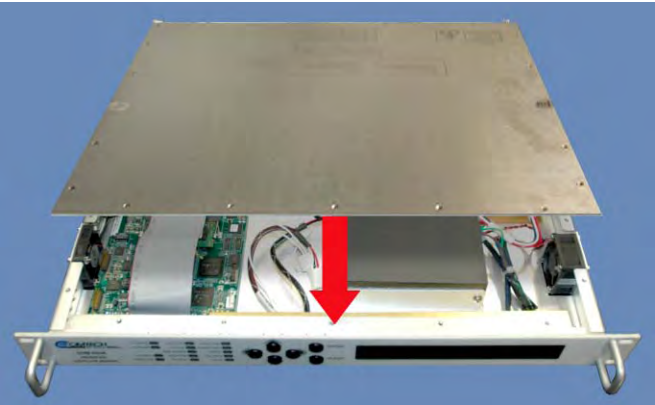
Step	Task
9	<p>Use the screwdriver to reinstall the top cover onto the CDM-625A chassis with its existing mounting hardware.</p> <p>Plug the modem's power cord back into its power source.</p> 

The CDM-625A IP Packet Processor upgrade is now complete. You may turn on and resume use of the modem.

Appendix M. VERSAFEC / VERSAFEC-2 ACM (ADAPTIVE CODING AND MODULATION) OPTION

M.1 Overview



VersaFEC® and VersaFEC-2 are technologies that are wholly owned and developed by Comtech EF Data and Comtech AHA Enterprise Products Group. VersaFEC is a registered trademark of Comtech AHA Enterprise Products Group.

ACM (Adaptive Coding and Modulation) is a significant feature in the CDM-625A. It may be used with either VersaFEC or, for modems running Firmware Version 1.3.1 or later, with a VersaFEC-2 plug-in Option Card (see **Sect. M.13**), and activated with the appropriate FAST codes.

- ACM turns fade margin into increased link capacity – gains of 100% or more are possible, compared to traditional Constant Coding and Modulation (CCM). This is accomplished by automatically adapting the modulation type and FEC code rate to give highest possible throughput.
- ACM maximizes throughput regardless of link conditions (noise or other impairments, clear sky, rain fade, etc). Initial setup is easy, and then requires no further user intervention.
- With CCM systems, severe rain fading can cause the total loss of the link, and zero throughput. ACM keeps the link up (with lower throughput) – and can yield much higher system availability.
- ACM in the CDM-625A is used in conjunction with VersaFEC and is currently for *IP traffic only*.

M.2 Background

ACM has been used for some time in wireless communications, including terrestrial microwave applications and, more recently, over satellite links. Its primary function is to optimize throughput in a wireless data link, by adapting the modulation order used and the Forward Error Correction code rate – both of which directly affect spectral efficiency (expressed in bits per second per Hertz) according to the noise conditions (or other impairments) on the link. Implicit in this concept is that the symbol rate (and power) of the wireless communication system *must remain constant*. This ensures that the bandwidth allocated for a particular link is never exceeded.

Given that the symbol rate does not change, if modulation and coding are changed, the data rate must therefore be modified. This is expressed in the simple equation:

$$\text{Symbol rate} = \text{bit rate} / (\text{modulation order} * \text{code rate})$$

For example, for Rate 3/4 QPSK (where modulation order = 2):

$$\text{Symbol rate} = \text{bit rate} * 0.666$$

Re-arranging:

$$\text{Bit rate} = \text{symbol rate} * \text{modulation order} * \text{code rate}$$

So, in changing to a higher modulation order or code rate, the bit rate is **increased**, and in changing to a lower modulation order or code rate, the bit rate is **reduced**. However, some important factors must be considered:

- **The digital communications system must be able to tolerate a change in bit rate.**

Synchronous serial interfaces (such as G.703 E1, which operated at a fixed data rate of 2.048 Mbps) are totally unsuitable in a scheme where data rate is changing. The only practical application for this scheme is a packet-based scheme that will tolerate a change in data rate, and which has mechanisms within its protocols to recognize when increased or reduced bandwidth is available. The best example of this is Ethernet, and this discussion is limited to schemes that employ it.

- **The bit rate cannot be changed arbitrarily.**

The link noise conditions, described in terms of E_b/N_0 or SNR, must be able to support reliable communications for the given modulation order and code rate. This is a key point as, in fact, *the link SNR is the input that drives the adaptation*.

M.3 Requirements for ACM

A generic example of ACM-over-Satellite is shown in **Figure M-1**. There are a number of essential requirements for enabling this scheme:

- 1) A modulator and FEC encoder that can instantaneously, when commanded, change either modulation type (order) or FEC encoder rate, or both. This needs to be accomplished without the corruption of data anywhere in the path. Block FEC codes are considered to be the most practical in achieving the required synchronization. A specific nomenclature has emerged to describe a combination of a modulation type and code rate – **ModCod** (also referred to as **Mod/Code**). The modulator is required to send the value of ModCod at the start of each code block to signal the demodulator/decoder how to configure for the correct modulation type and FEC code rate.
- 2) A receiver that is capable of demodulating and decoding the signal transmitted by a) without any *a priori* knowledge of when a change has taken place, but based purely on the value of ModCod seen at the start of each FEC block. Again, this needs to be accomplished without the corruption of data anywhere in the path.
- 3) The receiver in b) needs to derive an estimate of the link quality (in terms of E_b/N_0 , SNR, etc) and then communicate this estimate, via a return channel, to the modulator in a).
- 4) The modulator in a) needs to be able to process the link quality metric from the demodulator in b), and then, based upon a pre-determined algorithm, adapt the data rate and change the ModCod sent to the receiver at the distant end. Thus, the data rate on the link can be maximized, given the current link noise conditions.

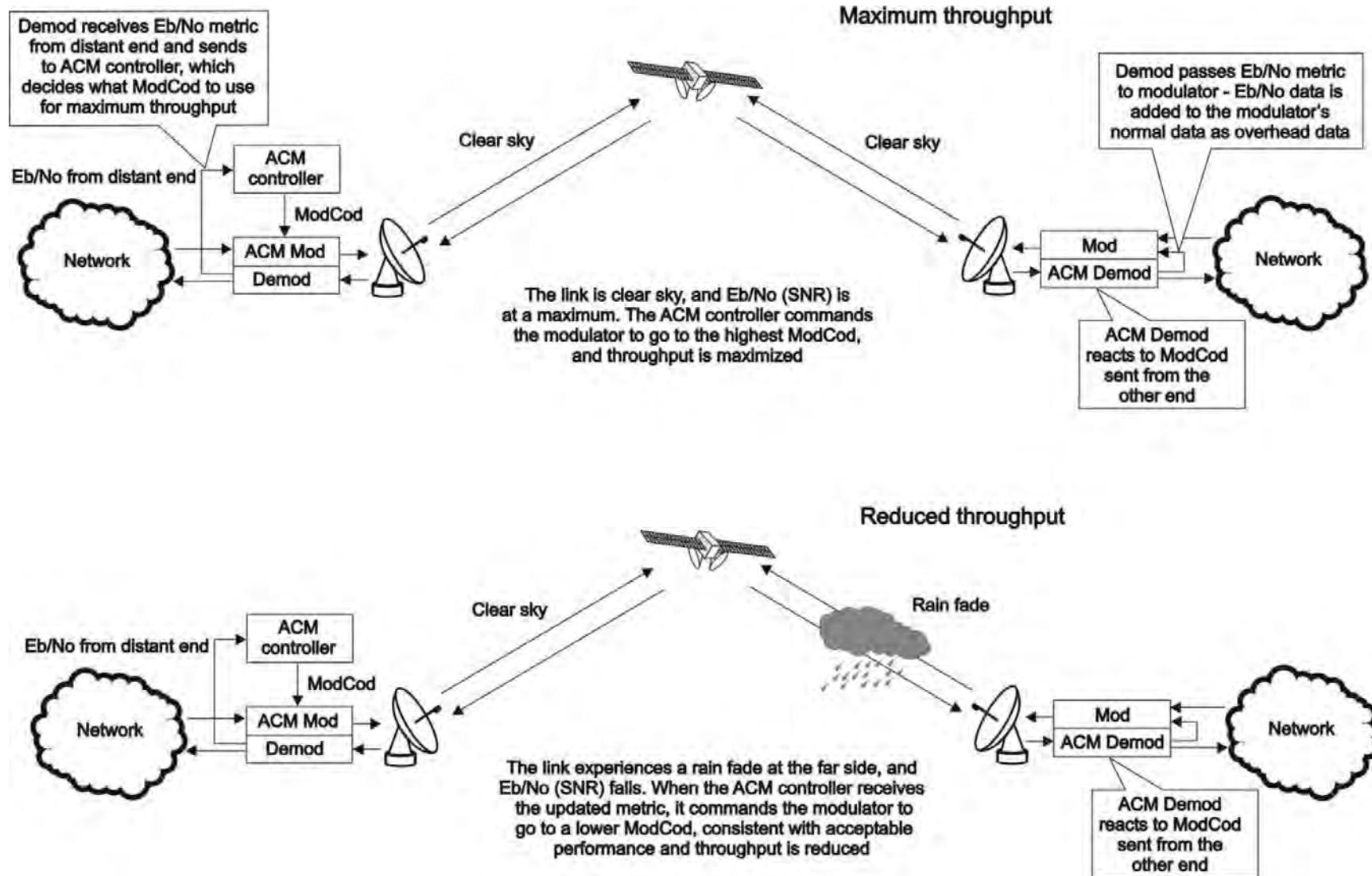

Figure M-1. ACM-over-Satellite – Generic Example

M.4 An Existing Satellite ACM Scheme

The best-known scheme for ACM-over-Satellite is addressed in the DVB-S2 specification (EN 302307) ratified by ETSI in March 2005. Hughes Network Systems (Germantown, MD) has commercially deployed DVB-S2 with ACM-over-Satellite.

While primarily for digital video broadcast, the DVB-S2 specification also encompasses two-way interactive services.

A summary of the main transmission aspects follows:

- Four modulation types are defined: QPSK, 8PSK, 16APSK, and 32APSK.
- The primary FEC type is low-density parity check coding (LDPC), concatenated with a short BCH code.
- The 8PSK, 16APSK, and 32APSK modulation types use interleaving.
- There are ten code rates defined: 1/4, 1/3, 2/5, 1/2, 3/5, 2/3, 3/4, 4/5, 5/6, 8/9, and 9/10 which depend on the modulation type and other system requirements.
- A single FEC block may be 64800 bits (normal, referred to as 64k blocks) or 16200 bits (short, referred to as 16k blocks)
- Adaptive Coding and Modulation is defined for optimizing satellite transponder capacity.

M.5 Disadvantages of DVB-S2

While the scheme defined by DVB-S2 is very effective for many broadcast and higher data rate applications, it is by no means a 'one size fits all' solution. Some of the disadvantages are as follows:

- **Excessive latency.** The so-called short blocks are too long for low latency IP applications at low data rates. This is exacerbated by the addition of interleaving.
- **Overly complex in its implementation.** The design of DVB-S2 dictated that all FEC blocks should be constant in *bits*. This means that for each ModCod, there are a varying number of *symbols*. This then makes the task of synchronization a much more demanding task. Also, because of the limitations of tracking the higher-order modulations in a very low SNR environment, so-called pilot symbols were added in order to aid tracking.
- **Concatenated BCH code added to mitigate the problem of error rate 'flaring' and 'flooring'.** This is no longer necessary. Since the introduction of the original LDPC/BCH scheme an enormous amount of research has been done on the design of LDPC codes. Most importantly, however, LDPC codes can now be designed that yield almost equivalent coding gain, but with considerably shorter block lengths.

- **In an ACM mode, no overhead channel was defined by DVB-S2 for the purpose of reporting SNR metrics to the originating end.** It has been left to individual equipment manufacturers to decide their own method. This illustrates that all ACM systems, DVB-S2 or not, are proprietary. In addition, it implies that additional bandwidth needs to be consumed for the SNR reporting, and this is not accounted for in the code rate.

M.6 VersaFEC ACM

VersaFEC, in concert with a novel ACM approach, addresses some of the shortcomings of DVB-S2 outlined above.

VersaFEC covers a family of 18 short-block LDPC ModCods, specifically designed for low latency and ACM applications. However, the VersaFEC codes are equally well suited to Constant Coding and Modulation (CCM) applications.

The requirements for an ACM system that approaches the minimum possible latency are:

- The shortest possible LDPC codes that give performance at or very close to DVB-S2, in order to minimize latency, and which do not use interleaving.
- Design of the encoder to further reduce latency to the minimum possible.
- A constant number of **symbols** per block, to reduce the demodulator and decoder complexity, and significantly, also reduces latency in the ACM case.
- The elimination of the need for pilot symbols for carrier tracking at low SNR by substitution of other modulation techniques. This further reduces the complexity of the demodulator.
- Reduction in the number of ModCods to further reduce complexity.
- The inclusion, at the physical layer, of an overhead channel to permit the reporting of SNR metrics back to the originating end. Note that this does not have to be enabled or disabled – it is part of the fundamental frame structure of VersaFEC ACM, and has been taken into account in the code rate.

The family of VersaFEC short-block LDPC codes is presented in **Table M-1**. The modulation types include BPSK, QPSK, 8-QAM, and 16-QAM. This table shows that, in order to maintain a constant number of symbols per block, the block size in bits (data + parity) must necessarily change, depending on both the modulation type (which affects the number of bits per symbol) and the code rate. For VersaFEC, the block size varies between 2k and 8.2k bits. At worst, therefore, the VersaFEC codes are 50% shorter than the ‘short’ DVB-S2 codes.

Table M-1. The VersaFEC ModCod set

Modulation	Code Rate	Spectral efficiency, bps/Hz	Block size, bits	Typical Eb/No, for BER = 5 x 10 ⁻⁸	Latency at 64 kbps, in milliseconds	Min. Data Rate, CCM mode	Max. Data Rate, CCM mode
BPSK	0.488	0.49	2k	2.4 dB	26	18 kbps	5.7 Mbps
QPSK	0.533	1.07	4.1k	2.2 dB	53	20 kbps	10 Mbps
QPSK	0.631	1.26	4.1k	2.7 dB	59	23 kbps	10 Mbps
QPSK	0.706	1.41	4.1k	3.4 dB	62	26 kbps	10 Mbps
QPSK	0.803	1.61	4.1k	3.8 dB	66	28 kbps	12 Mbps
8-QAM	0.642	1.93	6.1k	4.6 dB	89	35 kbps	12 Mbps
8-QAM	0.711	2.13	6.1k	5.2 dB	93	39 kbps	12 Mbps
8-QAM	0.780	2.34	6.1k	5.6 dB	97	43 kbps	12 Mbps
16-QAM	0.731	2.93	8.2k	6.3 dB	125	53 kbps	12 Mbps
16-QAM	0.780	3.12	8.2k	7.0 dB	129	57 kbps	14 Mbps
16-QAM	0.829	3.32	8.2k	7.5 dB	131	60 kbps	14 Mbps
16-QAM	0.853	3.41	8.2k	8.0 dB	132	62 kbps	16 Mbps

The VersaFEC codes compared with the Shannon bound are shown in **Figure M-2**. It can be seen that the performance of VersaFEC at or near the DVB-S2 performance with 16 kbit blocks.

Note that SNR is used in place of Eb/No, a convention for comparing ACM ModCods. SNR is defined as $E_b/N_0 + 10_{\log}(\text{Spectral Efficiency})$.

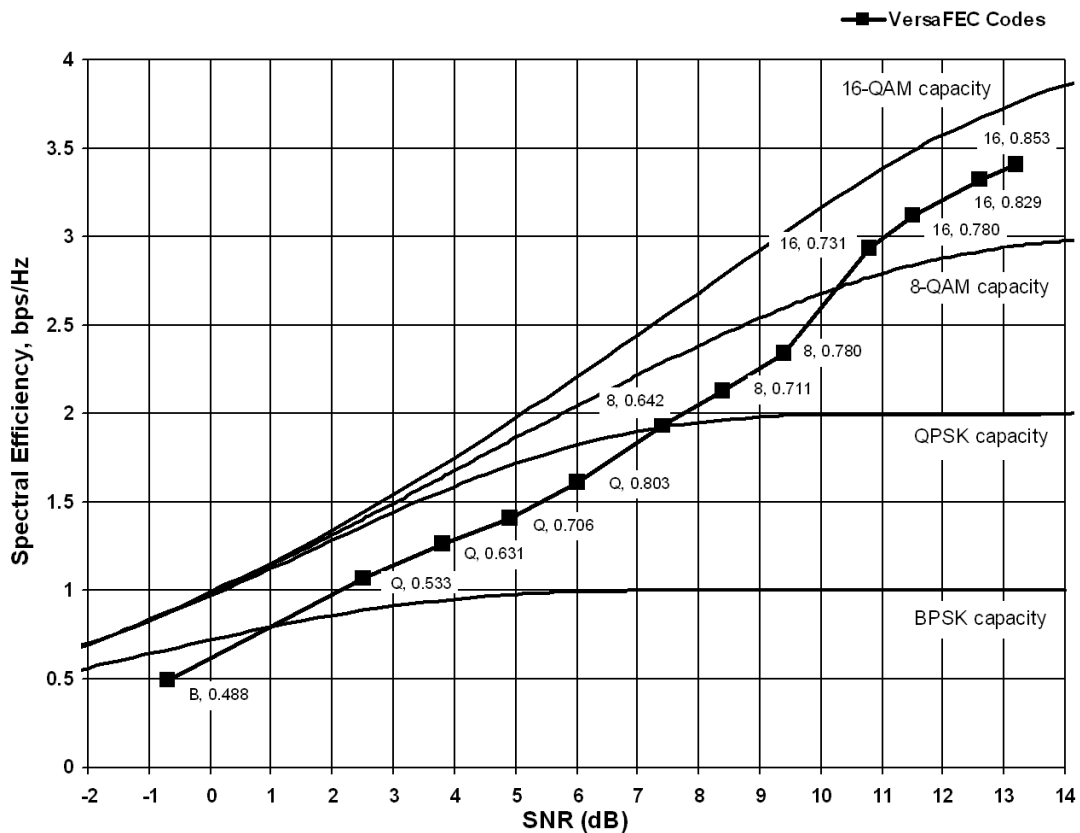

Figure M-2. VersaFEC Codes vs. Constrained Capacity

M.6.1 VersaFEC ACM Latency

In an ACM system that has a number of ModCods, each having a different latency, what defines the overall system latency? The answer is simple – the latency of the worst-case ModCod. (This may not seem obvious to some, and it is beyond the scope of this appendix to provide a rigorous defense of this statement. It *is*, however, a correct statement despite certain believers in non-causal systems and encoders that possess the magical quality of negative latency...)

Examining the data in **Table M-2**, latency for each ModCod is shown for the example of VersaFEC ACM at a fixed 100 ksymbols/second rate. Of particular note is that even though the ModCods span a 7:1 variation in throughput, the latency is only varying between 25 and 34 milliseconds. A careful analysis will show that this is a consequence of using a **constant number of symbols per block**. In the example shown the worst-case latency for this ACM scheme is 34 milliseconds.

Table M-2. VersaFEC Implementation of ACM – 100 ksymbols/sec Example Case

ModCod	Modulation	Code Rate	Spectral efficiency, bps/Hz	Bit rate (throughput)	Minimum Latency, In milliseconds
00	BPSK	0.488	0.49	49 kbps	34
01	QPSK	0.533	1.07	107 kbps	32
02	QPSK	0.631	1.26	126 kbps	30
03	QPSK	0.706	1.41	141 kbps	28
04	QPSK	0.803	1.61	161 kbps	26
05	8-QAM	0.642	1.93	193 kbps	30
06	8-QAM	0.711	2.13	213 kbps	28
07	8-QAM	0.780	2.34	234 kbps	27
08	16-QAM	0.731	2.93	293 kbps	27
09	16-QAM	0.780	3.12	312 kbps	26
10	16-QAM	0.829	3.32	332 kbps	25
11	16-QAM	0.853	3.41	341 kbps	25
OVERALL SYSTEM LATENCY = Worst-case ModCod (ModCod0) Latency = 34 milliseconds, NOT INCLUDING WAN BUFFER OR SATELLITE PATH					

By way of comparison, consider the same 100 ksymbols/second rate, but this time using DVB-S2. It becomes clear that there is an unintended penalty (besides demodulator complexity) to having a **constant number of bits per block**. Each time the ModCod is lowered and the throughput is reduced, the latency grows accordingly due to the block size being related to data rate, not symbol rate.

Remembering that, for the ACM case, the system latency is equal to the latency of the worst-case ModCod, DVB-S2 shows a severe penalty. For 16k short blocks, this calculates to be 329 milliseconds (+ WAN Buffer delay) *versus* 34 milliseconds (+ WAN Buffer delay) for VersaFEC ACM. For 64k block DVB-S2, the core latency is 4 times higher. Assuming a WAN Buffer of 20 milliseconds:

- Latency for 64k block DVB-S2 ACM at 100 ksps = **1336 milliseconds**
- Latency for 16k block DVB-S2 ACM at 100 ksps = **349 milliseconds**
- Latency for VersaFEC ACM at 100 ksps = **54 milliseconds**



- For the example shown, the latency for a 16k block DVB-S2 ACM scheme is approximately 7 times higher than VersaFEC ACM.
- The latency for a 64k block DVB-S2 ACM scheme is approximately 25 times higher than VersaFEC ACM.

M.6.2 Configuring VersaFEC ACM in the CDM-625A





VersaFEC ACM requires the appropriate FAST code for the maximum operating symbol rate.



Chapter 6. FRONT PANEL OPERATION.

Do these steps to configure the CDM-625A for VersaFEC ACM operation from the CDM-625A front panel:

Step	Task	Front Panel VFD Mnemonic
1	(SELECT) CONFIG: MODE Set the Tx and Rx modes as IP-ACM.	<code>Mode:Tx=IP-ACM:None Rx=IP-ACM:None (422,V35,G703s,Audio,LVDS,HSSI,IP,ASI)</code>
2	(SELECT) CONFIG: TX → SYMB Enter the desired transmit symbol rate. Note that this is a fundamental departure from the way in which the modem is typically configured.	<code>Tx-IF Freq Power FEC Mod Symb Scrambler (Data 00192.000kbps, 00131.657kspss)(◀ ▶)</code> <code>TxSymbolRate = 01000.000 kspss (ACM Mode) Data Invert=Off Clock Invert=Off (◀ ▶↕)</code>
	<p>The Transmit symbol rate is limited by the FAST code installed. There are three options:</p> <ul style="list-style-type: none"> • 37 kspss to 300 kspss • 37 kspss to 1200 kspss • 37 kspss to 4100 kspss 	
3	(SELECT) CONFIG: TX → POWER If Manual mode is selected, enter the desired transmit output level. This will also be the Nominal Power value if AUPC is selected. If AUPC mode is selected, two additional choices are presented – Mode/Range and Alarm Action , as shown here: In all case except MEO (which is a very unusual mode) the mode is fixed at Normal . Enter the maximum permitted power increase, between 0.0 and 9.9 dB. You can chose to generate an alarm when the max power or min ModCod has been reached, or not at all. You can also chose what happens to Tx Power when the remote demod unlocks. The choices are Nominal Power , Max Power , or Hold .	<code>Output Power: Mode= Manual (Manual, AUPC) Level= -20.0 dB (◀ ▶↕)</code> <code>Output Power: Mode= AUPC (Manual, AUPC) Mode/range Alarm Action (◀ ▶↕)</code> <code>AUPC-ACM Mode = Normal (Normal, +/- Track) Max Permitted Power Increase: 3.0 dB (◀ ▶↕)</code> <code>Tx Alarm: None (MaxPwr, MinMCod, None) Rem Dmod Unlock Act=Nom Pwr(Nom, Max, Hold)</code>
4	(SELECT) CONFIG: RX → SYMB Enter the desired receive symbol rate. Note that asymmetric operation is supported – transmit and receive symbol rates do not have to be equal.	<code>RxIF Freq FEC Demod Symb Descram Eq EbNo (Data 02048.000kbps,02184.533kspss)(◀ ▶↕)</code> <code>RxSymbolRate = 01000.000 kspss (ACM Mode) Data Invert=Off Clock Invert=Off (◀ ▶↕)</code>

Step	Task	Front Panel VFD Mnemonic
5	<p>(SELECT) CONFIG: ACM → Configure the desired ACM operating parameters, by selecting the ACM submenu from the CONFIG: menu branch.</p> <p>Proceeding from the CONFIG: ACM submenu:</p> <p>a) → Min/Max-ModCod: Define the range of ModCods over which the system will operate. ModCod0 is BPSK Rate 0.488 (0.49 bps/Hz), while ModCod11 is 16-QAM Rate 0.853 (3.41 bps/Hz).</p> <p> If you wish to constrain the system to run at a fixed ModCod, set the Min and Max ModCod values to be equal.</p> <p> CAUTION – The value of Max ModCod may be limited by other FAST codes installed. For example, suppose the 4100 kbps FAST option is installed, and the symbol rate set to 4100 kbps, the theoretical maximum data rate would be 14 Mbps at ModCod 11. However, if CnC is being used, with a 10 Mbps FAST limit, the ACM Max ModCod will be limited to ModCod 7, or 9.6 Mbps.</p> <p>b) → Unlock-Action: Choose the desired action when the remote demod loses lock. This is important, as the ACM system depends on the feedback of the SNR metric from the remote demod to determine the optimum ModCod. The choices are:</p> <p style="padding-left: 40px;">Go to min Tx ModCod (<i>recommended</i>) –or– Maintain Tx ModCod</p> <p>c) → Target Eb/No margin: This is a VERY important parameter. The ACM system is designed to switch based on thresholds that correspond to a BER of 5×10^{-8} for each ModCod. However, in order to prevent oscillation around two ModCods at this exact value, 0.3 dB of hysteresis has been added. The switch points and the hysteresis are shown in Figure M-3.</p>	<pre>CONFIG: All Mode Tx Rx Clocks ACM CnC EDMAC Misc Mask Remote IP (◀ ▶)</pre> <pre>ACM Config: Min/Max-ModCod Unlock-Action Target-EbNo-Margin (◀ ▶)</pre> <pre>Min Modcod: 00 (B 0.488 0.488 bps/Hz) Max Modcod: 00 (B 0.488 0.488 bps/Hz)</pre> <pre>When distant-end demod loses lock: Go to min Tx ModCod (Maintain,Min) (◄)</pre> <pre>Target Eb/No Margin = 1.0 dB (0.0 - 4.5) (◄)</pre>

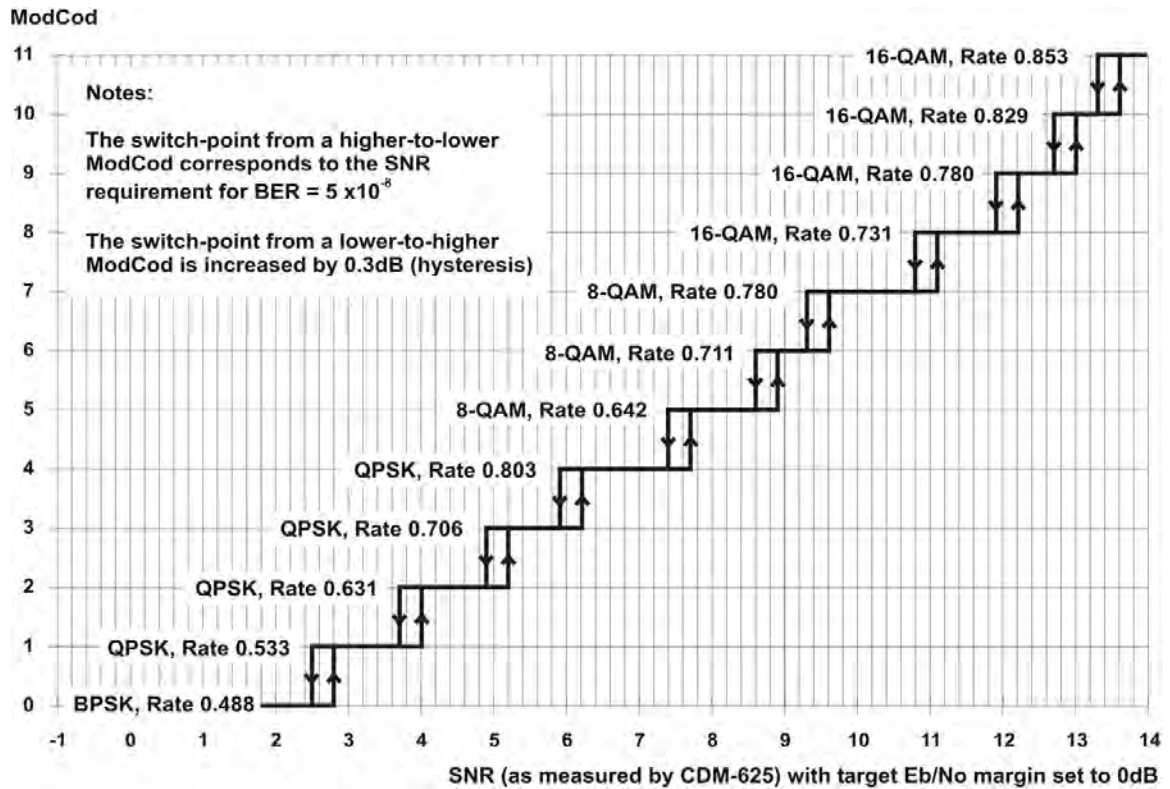

Figure M-3. CDM-625A – ACM ModCod Switch Points

The **Figure M-3** graph shows the switch points with the Target Eb/No margin set to 0dB. However, the switch points can be moved (increased) by configuring the Target Eb/No margin parameter, which can vary from 0 to 4.5 dB, in 0.5dB steps. In a fading environment, it is strongly recommended to add sufficient margin to maintain an adequate link quality (and to maintain demod lock) during the interval between the Eb/No degrading and the ACM controller responding by lowering the ModCod. See **Section M.11 Notes and Recommendations**.

To continue with the configuration:

Step	Task	Front Panel Mnemonic
6	(SELECT) CONFIG: IP → Switch-set-up → WAN Enter the desired size of the WAN Buffer. The minimum size is 20 milliseconds, and is referred to the data rate corresponding to ModCod0. <i>In order to achieve minimum system latency, do not make this value unnecessarily large.</i> . Note that this does not apply if the Packet Processor Card is installed.	Ethernet Switch: Mode WAN PerPortCnfg MAC-Learning VLAN Qos Stats (◀ ▶)

M.7 VersaFEC-2 ACM

Comtech EF Data's second generation VersaFEC-2 comprises 74 new ModCods, with a new family of constellations. This new functionality requires the plug-in VersaFEC-2 Option Card, Firmware Version 1.3.1 or higher, and activation of the appropriate FAST codes.

- **VersaFEC-2** has two modes:
 - **Long Block** – Maximum coding gain with higher latency.
 - 38 ModCods – BPSK to 32-ARY modulation, 9600 symbol block size.
 - Spectral efficiency up to 4.4 bps/Hz for Long Block VersaFEC-2.
 - **Short Block** – Slightly lower coding gain with much lower latency.
 - 36 ModCods - BPSK to 32-ARY modulation, 1600 symbol block size.
 - Short Block performance is, overall, considerably better than 1st generation VersaFEC, with similar latency performance.
 - Short Block deliberately limits throughput to 2 Mbps in CCM (Constant Coding and Modulation) and 1 Msps in ACM (Adaptive Coding and Modulation). Above these limits, latency is no longer an issue, and Long Block is preferred.
 - Spectral efficiency up to 4.15 bps/Hz for Short Block VersaFEC-2.
- CCM and point-to-point ACM are supported in both modes.
- In CCM, links can be run with VersaFEC-2 in one direction, and any other supported FEC type in the other (Example: Rx = VersaFEC-2, Tx = TPC).
- In ACM, the range of rate bit rate adaptation is approximately 9:1.
- In ACM, both sides need to be VersaFEC-2, but Tx and Rx can be Short or Long – no restrictions (but NOT compatible in any way with 1st generation VersaFEC).
- If VersaFEC-2 is used on both sides of the link then, even in CCM operation, the remote modem's Eb/No can be seen on the front panel display/web pages, etc, of the local modem.
- VersaFEC-2 has increased throughput compared to VersaFEC – the full symbol rate of 12.5 Msps, and full bit rate of 25 Mbps in CCM and ACM (Long Block) are supported.
- VersaFEC-2 provides five modulation types – BPSK, QPSK, 8-ARY, 16-ARY, and 32-ARY.
- VersaFEC-2 adds new circular or quasi-circular constellations for higher-order modulations (above QPSK) to replace the square VersaFEC constellations.

- Es/No span from -1.3 dB (ModCod 0) to 16.3 dB (ModCod 37), giving an average of approx. 0.45 dB per ModCod, and a 17.6 dB total span.
- The overhead associated with AUPC is eliminated. (A framed mode such as EDMAC is normally required.)
- Combined AUPC and ACM operation is possible - VersaFEC-2 permits up to 10 dB of AUPC power increase, followed by 17.6 dB of ACM range, for a total of 27.6 dB of fade protection.

Table M-3. The VersaFEC-2 ModCod Set – Long Block

ModCod	Modulation	Code Rate	Spectral efficiency, bps/Hz	Block size, bits	Typical * Es/No (SNR), for BER = 1×10^{-8} (dB)	Latency at 128 kbps (ms)	Min. Data Rate, CCM Mode (kbps)	Max. Data Rate, CCM Mode (Mbps)	Min Sym Rate, ACM Mode (ksps)	Max Sym Rate, ACM Mode (Msp)
00	BPSK	0.489	0.489	4800	-1.3	79	18.0	6.1	37	12.5
01	QPSK	0.489	0.977	9600	1.5	153	18.0	12.2	37	12.5
02	QPSK	0.537	1.075	10560	2.0	170	19.3	13.4	37	12.5
03	QPSK	0.586	1.173	11520	2.6	185	21.1	14.7	37	12.5
04	QPSK	0.611	1.221	12000	2.8	193	22.0	15.3	37	12.5
05	QPSK	0.635	1.270	12480	3.2	200	22.9	15.9	37	12.5
06	QPSK	0.660	1.319	12960	3.5	208	23.7	16.5	37	12.5
07	QPSK	0.684	1.368	13440	3.7	215	24.6	17.1	37	12.5
08	QPSK	0.733	1.466	14400	4.4	231	26.4	18.3	37	12.5
09	8-ARY	0.521	1.564	15360	5.1	246	28.1	19.5	37	12.5
10	8-ARY	0.537	1.612	15840	5.4	254	29.0	20.2	37	12.5
11	8-ARY	0.562	1.686	16560	5.6	265	30.3	21.1	37	12.5
12	8-ARY	0.586	1.759	17280	5.8	276	31.7	22.0	37	12.5
13	8-ARY	0.611	1.832	18000	6.0	287	33.0	22.9	37	12.5
14	8-ARY	0.635	1.906	18720	6.2	299	34.3	23.8	37	12.5
15	8-ARY	0.660	1.979	19440	6.5	311	35.6	24.7	37	12.5
16	8-ARY	0.684	2.052	20160	6.9	322	36.9	25.0	37	12.2
17	8-ARY	0.708	2.125	20880	7.2	333	38.3	25.0	37	11.8
18	8-ARY	0.733	2.199	21600	7.5	345	39.6	25.0	37	11.4
19	16-ARY	0.586	2.345	23040	8.1	368	42.2	25.0	37	10.7
20	16-ARY	0.611	2.443	24000	8.6	383	44.0	25.0	37	10.2
21	16-ARY	0.635	2.541	24960	8.9	398	45.7	25.0	37	9.8
22	16-ARY	0.660	2.638	25920	9.2	413	47.5	25.0	37	9.5
23	16-ARY	0.684	2.736	26880	9.6	429	49.3	25.0	37	9.1
24	16-ARY	0.708	2.834	27840	10.0	444	51.0	25.0	37	8.8
25	16-ARY	0.733	2.932	28800	10.5	459	52.8	25.0	37	8.5
26	16-ARY	0.757	3.029	29760	10.9	474	54.5	25.0	37	8.3
27	16-ARY	0.782	3.127	30720	11.4	489	56.3	25.0	37	8.0
28	32-ARY	0.660	3.298	32400	12.0	517	59.4	25.0	37	7.6
29	32-ARY	0.684	3.420	33600	12.5	535	61.6	25.0	37	7.3
30	32-ARY	0.708	3.542	34800	12.9	554	63.8	25.0	37	7.1
31	32-ARY	0.733	3.664	36000	13.3	573	66.0	25.0	37	6.8
32	32-ARY	0.757	3.787	37200	13.7	592	68.2	25.0	37	6.6
33	32-ARY	0.782	3.909	38400	14.2	610	70.4	25.0	37	6.4
34	32-ARY	0.801	4.007	39360	14.7	625	72.1	25.0	37	6.2
35	32-ARY	0.831	4.153	40800	15.2	648	74.8	25.0	37	6.0
36	32-ARY	0.855	4.275	42000	16.0	667	77.0	25.0	37	5.8
37	32-ARY	0.879	4.397	43200	16.7	685	79.2	25.0	37	5.7

Table M-4. The VersaFEC-2 ModCod Set – Short Block

ModCod	Modulation	Code Rate	Spectral efficiency, bps/Hz	Block size, bits	Typical * Es/No (SNR), for BER = 1×10^{-8} (dB)	Latency at 128 kbps (ms)	Min. Data Rate, CCM Mode (kbps)	Max. Data Rate, CCM Mode (Mbps)	Min Sym Rate, ACM Mode (ksps)	Max Sym Rate, ACM Mode (Msps)
00	BPSK	0.489	0.489	800	-0.2	16	18.0	2.0	37	1
01	QPSK	0.489	0.977	1600	2.3	30	18.0	2.0	37	1
02	QPSK	0.537	1.075	1760	2.8	33	19.3	2.0	37	1
03	QPSK	0.586	1.173	1920	3.4	36	21.1	2.0	37	1
04	QPSK	0.611	1.221	2000	3.7	37	22.0	2.0	37	1
05	QPSK	0.635	1.270	2080	3.9	38	22.9	2.0	37	1
06	QPSK	0.660	1.319	2160	4.2	39	23.7	2.0	37	1
07	QPSK	0.684	1.368	2240	4.5	41	24.6	2.0	37	1
08	QPSK	0.733	1.466	2400	5.2	43	26.4	2.0	37	1
09	8-ARY	0.521	1.564	2560	5.6	46	28.1	2.0	37	1
10	8-ARY	0.537	1.612	2640	5.9	47	29.0	2.0	37	1
11	8-ARY	0.562	1.686	2760	6.2	49	30.3	2.0	37	1
12	8-ARY	0.586	1.759	2880	6.4	51	31.7	2.0	37	1
13	8-ARY	0.611	1.832	3000	6.6	53	33.0	2.0	37	1
14	8-ARY	0.635	1.906	3120	6.9	55	34.3	2.0	37	1
15	8-ARY	0.660	1.979	3240	7.2	57	35.6	2.0	37	1
16	8-ARY	0.684	2.052	3360	7.5	59	36.9	2.0	37	1
17	8-ARY	0.708	2.125	3480	7.8	61	38.3	2.0	37	1
18	8-ARY	0.733	2.199	3600	8.3	63	39.6	2.0	37	1
19	16-ARY	0.586	2.345	3840	8.7	67	42.2	2.0	37	1
20	16-ARY	0.611	2.443	4000	9.0	70	44.0	2.0	37	1
21	16-ARY	0.635	2.541	4160	9.3	73	45.7	2.0	37	1
22	16-ARY	0.660	2.638	4320	9.7	76	47.5	2.0	37	1
23	16-ARY	0.684	2.736	4480	10.3	79	49.3	2.0	37	1
24	16-ARY	0.708	2.834	4640	10.7	82	51.0	2.0	37	1
25	16-ARY	0.733	2.932	4800	11.0	85	52.8	2.0	37	1
26	16-ARY	0.757	3.029	4960	11.6	88	54.5	2.0	37	1
27	16-ARY	0.782	3.127	5120	12.2	91	56.3	2.0	37	1
28	32-ARY	0.660	3.298	5400	12.8	93	59.4	2.0	37	1
29	32-ARY	0.684	3.420	5600	13.1	96	61.6	2.0	37	1
30	32-ARY	0.708	3.542	5800	13.4	99	63.8	2.0	37	1
31	32-ARY	0.733	3.664	6000	14.0	102	66.0	2.0	37	1
32	32-ARY	0.757	3.787	6200	14.4	105	68.2	2.0	37	1
33	32-ARY	0.782	3.909	6400	14.8	109	70.4	2.0	37	1
34	32-ARY	0.801	4.007	6560	15.2	112	72.1	2.0	37	1
35	32-ARY	0.831	4.153	6800	15.8	117	74.8	2.0	37	1

* Typical Es/No values are shown – guaranteed values are 0.3 dB higher

Note that Es/No (SNR) is used in place of Eb/No, a convention for comparing ACM ModCods. SNR is defined as:

$$Es/No = Eb/No + 10 * \log_{10} (\text{Spectral Efficiency})$$

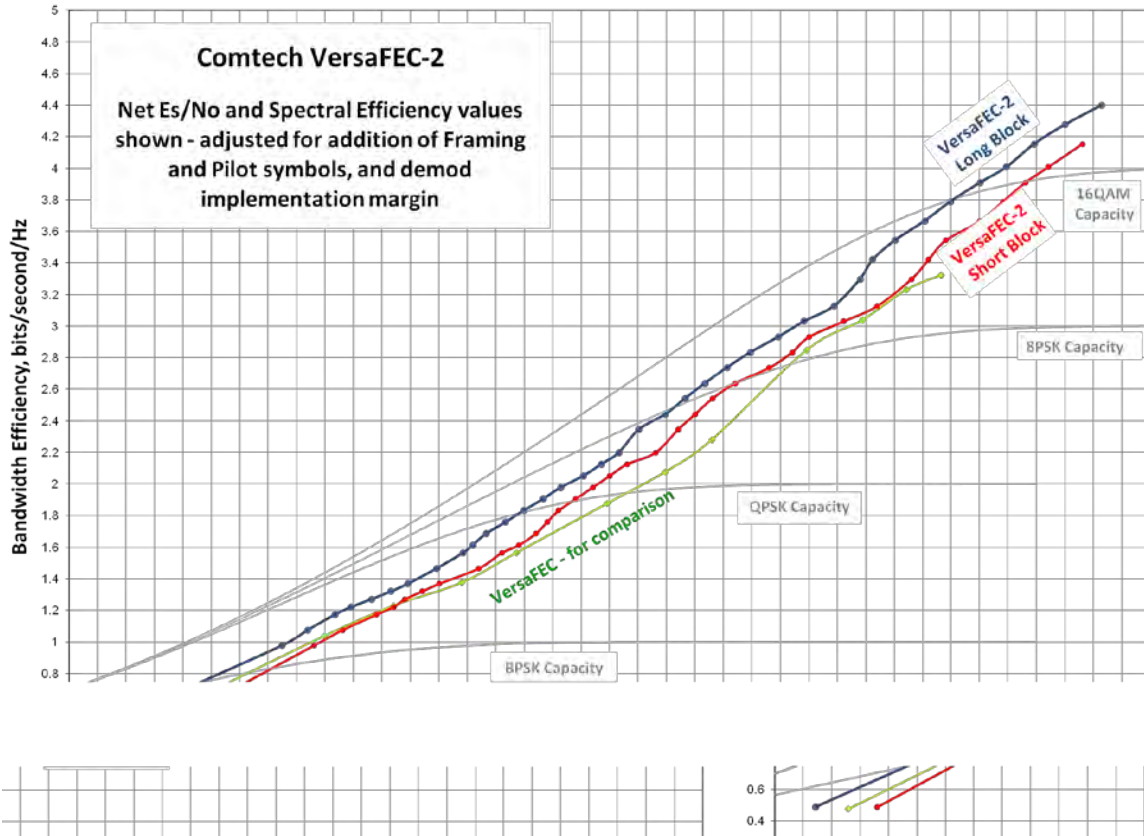

Figure M-4. VersaFEC-2 Codes vs. Constrained Capacity (typical values shown)

M.7.1 VersaFEC-2 ACM latency

Section M.6.1 addresses latency in VersaFEC ACM mode. The analysis for VersaFEC-2 is proceeds identically. The following table shows a summary for both VersaFEC-2 Long and Short Block modes:

	Min Throughput @ 100 ksps	Max Throughput @ 100 ksps	End-to-end Latency
VersaFEC-2 Short Block	48.9 kbps	415.3 kbps	40.4 ms
VersaFEC-2 Long Block	48.9 kbps	439.7 kbps	205 ms

Table M-5. VersaFEC-2 End-to-End Latency @ 100 ksps

As explained in Section M.6.1, these figures do not include the WAN buffer latency (where used).

M.7.2 Configuring VersaFEC-2 ACM in the CDM-625A





VersaFEC-2 ACM requires the plug-in Option Card , and the appropriate FAST code for the maximum operating symbol rate.



Chapter 6. FRONT PANEL OPERATION.

Do these steps to configure the CDM-625A for VersaFEC-2 ACM operation from the CDM-625A front panel:

Step	Task	Front Panel VFD Mnemonic
1	(SELECT) CONFIG: MODE Set the Tx and Rx modes as V2-ACM.	Mode:Tx=V2-ACM:None Rx=V2-ACM:None (422,V35,G703s,Audio,LVDS,HSSI,IP,ASI)
2	(SELECT) CONFIG: TX → FEC Set the Tx FEC type as VersaFEC-2 Long, or VersaFEC-2 Short Block	Tx-IF Freq Power FEC Mod Symb Scrambler (Data 00192.000kbps, 00131.657ksps)(◀ ▶) Enc=VF2L(VF2L, VF2S) Reed-Solomon=Off (Fixed in ACM) (◀ ▶↕)
3	(SELECT) CONFIG: TX → SYMB Enter the desired transmit symbol rate. Note that this is a fundamental departure from the way in which the modem is typically configured.	Tx-IF Freq Power FEC Mod Symb Scrambler (Data 00192.000kbps, 00131.657ksps)(◀ ▶) TxSymbolRate = 01000.000 ksps (ACM Mode) Data Invert=Off Clock Invert=Off (◀ ▶↕)
	 <p>The Transmit symbol rate is limited by the FAST code installed. There are five options:</p> <ul style="list-style-type: none"> • 37 ksps to 1200 ksps • 37 ksps to 8000 ksps • 37 ksps to 2000 ksps • 37 ksps to 12500 ksps • 37 ksps to 4100 ksps 	
4	(SELECT) CONFIG: TX → POWER If Manual mode is selected, enter the desired transmit output level. This will also be the Nominal Power value if AUPC is selected. If AUPC mode is selected, two additional choices are presented – Mode/Range and Alarm Action , as shown here: In all case except MEO (which is a very unusual mode) the mode is fixed at Normal . Enter the maximum permitted power increase, between 0.0 and 9.9 dB. You can chose to generate an alarm when the max power or min ModCod has been reached, or not at all. You can also chose what happens to Tx Power when the remote demod unlocks. The choices are Nominal Power , Max Power , or Hold .	Output Power: Mode= Manual (Manual, AUPC) Level= -20.0 dBm (◀ ▶↕) Output Power: Mode= AUPC (Manual, AUPC) Mode/range Alarm Action (◀ ▶↕) AUPC-ACM Mode = Normal (Normal, +/- Track) Max Permitted Power Increase: 3.0 dB (◀ ▶↕) Tx Alarm: None (MaxPwr, MinMCod, None) Rem Dmod Unlock Act=Nom Pwr (Nom, Max, Hold)

Step	Task	Front Panel VFD Mnemonic
5	<p>(SELECT) CONFIG: RX → FEC Set the Rx FEC type as VersaFEC-2 Long, or VersaFEC-2 Short Block. Note that this does not have to match the Tx FEC type.</p>	<pre>RxIF Freq FEC Demod Symb Descram Eq EbNo (Data 02048.000kbps,02184.533ksps)(◀▶↕) Dec=VF2L(VF2L, VF2S) Reed-Solomon=Off (Fixed in ACM) (◀▶↕)</pre>
6	<p>(SELECT) CONFIG: RX → SYMB Enter the desired receive symbol rate. Note that asymmetric operation is supported – transmit and receive symbol rates do not have to be equal.</p>	<pre>RxIF Freq FEC Demod Symb Descram Eq EbNo (Data 02048.000kbps,02184.533ksps)(◀▶↕) RxSymbolRate = 01000.000 ksps (ACM Mode) Data Invert=Off Clock Invert=Off (◀▶↕)</pre>
7	<p>(SELECT) CONFIG: ACM → Configure the desired ACM operating parameters, by selecting the ACM submenu from the CONFIG: menu branch.</p> <p>Proceeding from the CONFIG: ACM submenu:</p> <p>a) → Min/Max-ModCod: Define the range of ModCods over which the system will operate. ModCod 0 is fixed at BPSK Rate 0.489 (0.489 bps/Hz), while ModCod 37 is 32-ARY Rate 0.879 (4.397 bps/Hz).</p> <p> In VersaFEC-2, the Minimum ModCod is fixed at 0, and the user cannot change it.</p> <p> CAUTION – The value of Max ModCod may be limited by other FAST codes installed. For example, suppose the 4100 kbps FAST option is installed, and the symbol rate set to 4100 kbps, the theoretical maximum data rate would be ~18 Mbps at ModCod 37. However, is CnC is being used, with a 10 Mbps FAST limit, the ACM Max ModCod will be limited to ModCod 21, or 9.8 Mbps.</p> <p>b) → Unlock-Action: For VersaFEC-2 the unlock action is fixed. In the event that the distant-end demod loses lock, the Tx ModCod will automatically go to ModCod 0.</p> <p>c) → Target Eb/No margin: This is a VERY important parameter. The ACM system is designed to switch based on thresholds that correspond to a BER of 1×10^{-8} for each ModCod. However, in order to prevent oscillation around two ModCods at this exact value, 0.3 dB of hysteresis has been added.</p>	<pre>CONFIG: All Mode Tx Rx Clocks ACM CnC EDMAC Misc Mask Remote IP (◀▶) ACM Config: Min/Max-ModCod Unlock-Action Target-EbNo-Margin (◀▶) Min Modcod: 00(B 0.489, 0.489 bps/Hz) Max Modcod: 37(32-ARY 0.879, 4.397 bps/Hz)</pre> <pre>When distant-end demod loses lock: Go to Tx ModCod 0 (Fixed in VersaFEC-2)</pre> <pre>Target Eb/No Margin = 0.5 dB (0.0 - 4.5) (↕)</pre>
8	<p>(SELECT) CONFIG: IP → Switch-set-up → WAN Enter the desired size of the WAN Buffer. The minimum size is 20 milliseconds, and is referred to the data rate corresponding to ModCod 0. Note that this does not apply if the Packet Processor Card is installed.</p>	<pre>Ethernet Switch: Mode WAN PerPortCnfg MAC-Learning VLAN Qos Stats (◀▶)</pre>

M.8 Monitoring ACM Performance

The CDM-625A provides several ways to determine the current state of the ACM system.

Use the front panel menu to select **MONITOR: ACM**. The current Tx and Rx ModCod, along with the Local and Remote SNR, are displayed here. The SNR displays values between -3.0 dB and $+22.0$ dB, with a resolution of 0.1 dB. If either the local or remote demod is unlocked, the SNR will show 'No Sync'

If you wish to see the exact detail of the ModCod (data rate, modulation, code rate), then these parameters can be seen under **INFO: TX** or **INFO: Rx**. Furthermore, if you are in a **CONFIG: TX** or **CONFIG: RX** screen, both the symbol rate and data rate are displayed. All of these screens update dynamically, so if a ModCod changes, the parameters are refreshed.

This information is also available through the Remote Control (serial interface), as well as the Web Server, SNMP and Telnet interfaces.

If you wish to use the 'Constellation over Ethernet' application that comes with the released code, it is also informative to see the demodulator changing type 'on the fly'. With no noise, and a modem in a loop on itself, you may wish to experiment with Min and Max ModCod values to drive the adaptation.

Alternately, if you have access to an Oscilloscope in X-Y mode, the Alarms connector provides analog voltages to monitor the constellation. This has the advantage that it will show a change in modulation type instantaneously, unlike the 'Constellation over Ethernet' application, which only updates once per second.

If you wish to verify that link performance is meeting the required level, the internal BERT tester is an excellent tool. When using the IP interface it is not an easy matter to verify BER performance, but the internal BERT will not only do this, but is also tolerant of the change in bit rate that accompanies a change in ModCod. The BERT can be used to confirm that there are no sync losses or bursts of bit errors when a ModCod changes.

M.9 ACM Congestion Control

When the ACM controller switches from a lower to a higher ModCod the bandwidth of the Ethernet link is instantaneously increased. This is not a problem, and the link will adapt to push more packets/second through the link.

Conversely, when the ACM controller switches from a higher to a lower ModCod the bandwidth of the Ethernet link is instantaneously reduced. Unless the FIFO in the WAN encapsulator is configured to be very large, the FIFO will tend to overflow, and packets will be lost before the network recognizes that there is congestion, and reduces the rate at which packets are sent.

In order to mitigate packet loss when bandwidth is reduced, the CDM-625A ACM system incorporates a method for congestion control that is illustrated in **Figure M-5**.

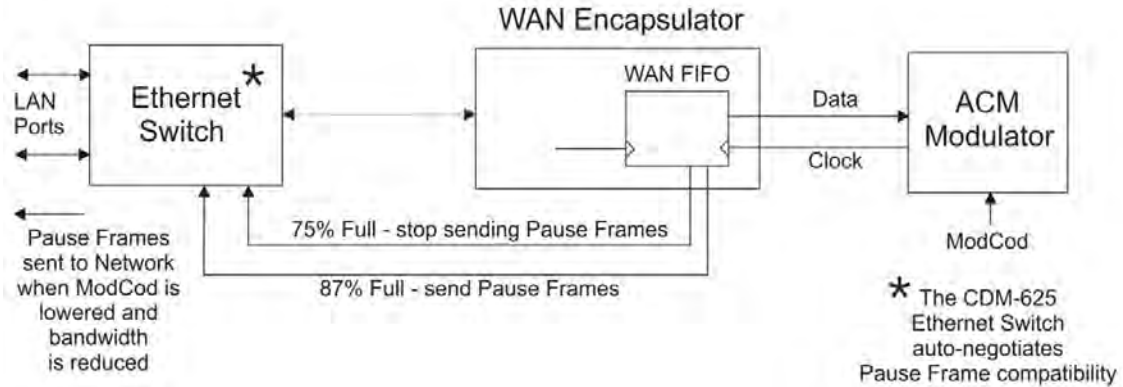

Figure M-5. CDM-625A – ACM Congestion Control

The WAN FIFO (the size of which is configurable in the IP Switch setup) produces two control signals that enable and disable the sending of Ethernet **Pause Frames**. A Pause Frame is an Ethernet frame designed to implement flow control at the MAC layer. A switch supporting 802.3x can send a Pause Frame (with Pause time set to 0xFFFF) to force the link partner to stop sending data. Devices use the Auto-Negotiation protocol to discover the Pause Frame capabilities of the device at the other end of the link.

In the diagram it can be seen that when the WAN FIFO reaches a fill state of 87%, it signals the Ethernet Switch to send Pause frames back to the LAN to inhibit the sending of further data. The Pause Frames continue to be sent until the FIFO fill state has reduced to 75%. At this point, normal operation is resumed by sending a Pause Frame with Pause time set to 0x0000. This mechanism has been shown to be very effective at mitigating packet loss when the ACM controller reduces bandwidth.

M.10 Using ACM with AUPC

The adaptation algorithm has been extended so that, in a fading environment, AUPC (Automatic Uplink Power Control) is the first method used to protect the link. When the increase in power reaches a defined maximum, power no longer increases with increasing fade depth, but remains constant, at which point the algorithm switches to ACM in order to protect the link.

The AUPC scheme is, in most respects, identical to the 'standard' AUPC found in the CDM-625A. The significant difference is that it **does not require an additional overhead mode to be selected** (such as EDMAC) in order to transmit SNR metrics to the other end of the link. This saves between 1.6 and 5% of the occupied bandwidth.

See **Section M.6.2 Configuring VersaFEC ACM in the CDM-625A** and **Section 0 Configuring VersaFEC ACM in the CDM-625A** for setup details.

You can select up to 9.9 dB of AUPC range before the algorithm switches to ACM.

M.11 Notes and Recommendations

- VersaFEC and VersaFEC-2 ACM are for point-to-point applications. It is required that both directions on the link run in IP-ACM or V2-ACM mode, although the symbol rates do not need to be equal. For VersaFEC, if you wish to constrain one direction to run in CCM, simply set the Min and Max ModCod to be equal. Note, however, that VersaFEC and VersaFEC-2 cannot be mixed on the same bi-directional link.
- ACM constitutes a closed-loop control system (very similar in concept to AUPC) and it should be remembered that like all control systems, the speed at which the system can react is governed by a number of factors, including the time taken to estimate SNR to the required accuracy, and the transport delay over the satellite. Realistically, it can cope with fading and other link impairments that do not exceed 1dB/second (more if Target Eb/No margin is increased).
- The ACM controller algorithm that resides in the CDM-625A modem exhibits a different response depending on whether SNR is increasing or decreasing. If the SNR is improving, the ACM controller switches to higher ModCods sequentially until the highest possible ModCod has been reached. It may, therefore, take several seconds for the link to reach maximum throughput. Conversely, if SNR is degrading rapidly (in a fade) then it can change, if needed, directly from ModCod11 to ModCod0 (VersaFEC example). This gives the fastest possible response and helps keep the link intact under fast fading events.
- While ACM can do remarkable things, the fundamentals still apply. Don't expect the demod to run at a 16-ARY ModCod if the SNR instantaneously drops to 0dB – the demod will lose lock and the system will recover by switching to ModCod0 (if so configured, in VersaFEC).



For VersaFEC, to achieve the most robust link performance, Comtech EF Data strongly recommends that you set the Minimum ModCod to 0 (the ModCod of last resort), and set the Unlock Action to 'Go to minimum ModCod'.

VersaFEC-2 automatically fixes the Minimum ModCod to 0, and the Unlock action is fixed to force the Tx side to automatically go to ModCod 0.

- For VersaFEC running in ACM mode the demodulator is performing *blind acquisition* – meaning that it has no *a priori* knowledge of the modulation type or code rate. For this reason the demodulator acquisition time will be slower than in CCM mode. However, the acquisition time is typically under 1 second for all symbol rates and noise conditions.

For VersaFEC-2 running in ACM mode, acquisition is always at ModCod0, so acquisition time is considerably quicker than VersaFEC.

- Running the ACM link with the Target Eb/No Margin set to 0dB will give the best utilization of link power, but in conditions of fast fading may cause demod unlock events, or highly degraded BER just prior to the switch to a lower ModCod. In order to mitigate this, we recommend a Target Eb/No Margin of at least 0.5dB – more if the fading events are particularly severe and/or frequent.

- For VersaFEC, the value of Max ModCod may be limited by other FAST codes installed in the CDM-625A. For example, suppose the 4100 kbps FAST option is installed, and the symbol rate set to 4100 kbps, the theoretical maximum data rate would be 14 Mbps at ModCod 11. However, if CnC is being used, with a 10 Mbps FAST limit, the ACM Max ModCod will be limited to ModCod 7, or 9.6 Mbps. Therefore, if it is not possible to set the Maximum ModCod to the desired value for a given symbol rate, you should check to determine what other FAST codes may be limiting it. The same applies for VersaFEC-2.
- The BER versus Eb/No performance of the ModCods is identical to the VersaFEC and VersaFEC-2 CCM modes described in **Appendix B. FEC (FORWARD ERROR CORRECTION) OPTIONS.**
- SNR is the preferred metric for driving the adaptation – this is the value displayed on the monitor screens. If you want to convert this to Eb/No then remember that the relationship is simply $Eb/No = SNR - 10_{\log}(\text{Spectral Efficiency})$.
- To achieve minimum latency, set the WAN buffer to the smallest practical value. This will depend on how well the connected equipment implements rate limiting, and the variation in IP packet size. The default setting is 20ms for VersaFEC, and 100ms for VersaFEC-2.
- All IP features that are available in the CDM-625A (VLAN, QoS, etc) are available when in IP-ACM mode. The Sub-Mux feature, however, is not available.
- VersaFEC and VersaFEC-2 ACM are 100% compatible with Carrier-in-Carrier.
- If required, VersaFEC ACM may be used in conjunction with any of the EDMAC modes, either for serial remote control of the remote modem, or for SNMP proxy. It should be emphasized, however, that unlike AUPC, a framing mode is **not** required for SNR reporting.
- ACM maximizes throughput not only when Eb/No varies due to atmospheric conditions, but will also mitigate the effects of other impairments, such as antenna pointing error, excessive phase noise and certain types of interference. However, rapidly fluctuating impairments (~ less than 1 second) such as scintillation at low antenna look-angles at C-band will generally not be improved by ACM.
- VersaFEC ACM modes are **not** compatible with VersaFEC CCM modes, due to differences in frame preambles. However, VersaFEC-2 ACM and CCM modes **are** compatible.

M.12 Summary of Specifications

M.12.1 VersaFEC ACM

System type	Adaptive Coding and Modulation, using BPSK, QPSK, 8-QAM , 16-QAM and VersaFEC short-block LDPC coding - total of 12 ModCods				
Symbol Rate Range	37 ksps to 4100 ksps				
Interface	10/100 Base T Ethernet, with auto-negotiated Congestion Control				
Remote SNR reporting	Automatically reported from remote modem – built in function at the physical layer – requires no additional overhead				
Max span of data rate	7:1 over range of adaptation				
Switch point (decreasing SNR)	Corresponds to SNR (Es/No) that gives BER = 5×10^{-8} (margin set to 0 dB)				
Switch point hysteresis	0.3 dB				
Max fading rate	Approximately 1 dB/second (higher if Target Eb/No margin > 1 dB)				
Max ModCod update rate	1 update every 2 seconds				
Configurable parameters	<ul style="list-style-type: none"> • Minimum and Maximum ModCod (ModCod0 through ModCod11) • Remote Demod Unlock Action: Maintain current ModCod Go to minimum ModCod • Target SNR margin (0 to 4.5 dB, 0.5 dB steps) 				
System latency	34 milliseconds max (not including WAN buffer, or satellite path)				
Monitored parameters	<ul style="list-style-type: none"> • Tx and Rx ModCods • Local and Remote SNR (-3.0 dB to +22.0dB, 0.1dB resolution, +/- 0.5 dB accuracy) • Config and monitor menus displaying data rate, modulation and code rate update dynamically with ModCod 				
Modulation	Code Rate	Spectral Efficiency, bps/Hz	Typical Eb/No, for BER = 5×10^{-8}	Min. Data Rate, ACM mode	Max. Data Rate, ACM mode
BPSK	0.488	0.49	2.4 dB	18.1 kbps	2.00 Mbps
QPSK	0.533	1.07	2.2 dB	39.6 kbps	4.38 Mbps
QPSK	0.631	1.26	2.7 dB	46.7 kbps	5.16 Mbps
QPSK	0.706	1.41	3.4 dB	52.2 kbps	5.78 Mbps
QPSK	0.803	1.61	3.8 dB	59.6 kbps	6.60 Mbps
8-QAM	0.642	1.93	4.6 dB	71.5 kbps	7.91 Mbps
8-QAM	0.711	2.13	5.2 dB	78.8 kbps	8.73 Mbps
8-QAM	0.780	2.34	5.6 dB	86.6 kbps	9.59 Mbps
16-QAM	0.731	2.93	6.5 dB	108.5 kbps	12.01 Mbps
16-QAM	0.780	3.12	7.1 dB	115.5 kbps	12.79 Mbps
16-QAM	0.829	3.32	7.7 dB	122.8 kbps	13.61 Mbps
16-QAM	0.853	3.41	8.1 dB	126.2 kbps	14.00 Mbps

M.12.2 VersaFEC-2 ACM

System type	Adaptive Coding and Modulation, using BPSK, QPSK, 8-ARY, 16-ARY, 32-ARY and VersaFEC-2 Short-block and Long Block LDPC coding - total of 74 ModCods
Symbol Rate Range	37 ksps to 12.5 Msps (Long)
Interface	10/100 Base T Ethernet, with auto-negotiated Congestion Control
Remote SNR reporting	Automatically reported from remote modem – built in function at the physical layer – requires no additional overhead
Max span of data rate	9:1 over range of adaptation
Switch point (decreasing SNR)	Corresponds to SNR (Es/No) that gives BER = 1×10^{-8} (margin set to 0 dB)
Switch point hysteresis	0.3 dB
Max fading rate	Approximately 1 dB/second (higher if Target Eb/No margin > 1 dB)
Max ModCod update rate	1 update every 1.7 seconds
Configurable parameters	<ul style="list-style-type: none"> • Maximum ModCod (ModCod0 through ModCod37, Long Block) • Maximum ModCod (ModCod0 through ModCod35, Short Block) • Remote Demod Unlock Action: Go to minimum ModCod • Target SNR margin (0 to 4.5 dB, 0.5 dB steps)
System latency @ 100 ksps	Long Block - 205 milliseconds max (not including WAN buffer, or satellite path) Short Block – 40.4 milliseconds max (not including WAN buffer, or satellite path)
Monitored parameters	<ul style="list-style-type: none"> • Tx and Rx ModCods • Local and Remote SNR (-3.0 dB to +22.0dB, 0.1dB resolution, +/- 0.5 dB accuracy) • Config and monitor menus displaying data rate, modulation and code rate update dynamically with ModCod
List of ModCods	See Tables M-3 and M-4

M.13 Field Upgrade Procedure – VersaFEC-2 Option Card

M.13.1 Overview

This section describes the field upgrade procedure you will need to follow to retrofit your CDM-625A-Advanced Satellite Modem with the optional VersaFEC-2 Option Card.

M.13.2 Requirements for Field Upgrade

- CDM-625A Advanced Satellite Modem with 175W AC or 125W DC Power Supply
- Medium Phillips™ screwdriver
- Needle-nose pliers
- CEFD P/N KT-0020932 VersaFEC-2 Option Card with Fan Upgrade Kit, containing:

CEFD Part Number	QTY	Description
PL-0000449	1	Fan Assembly, 40 x 40 x 10
FN/FGDC12V01	1	Fan Guard
HW/4-40X3/4PH	4	Screw, S.S., 4-40 x 3/4 LG, Pan Head Phillips
HW/440HXNUTLOC	4	Elastic Locking Hex Nut, S.S., 4-40
FP-0021510	1	Air Baffle
PL-0021334	1	CDM-625A VersaFEC-2 Option Card
HW/SEM440X1/4PH	1	Screw, S.S., 4-40 x 1/4 LG, Pan Head Phillips

M.13.3 Field Upgrade Procedure





CAUTION – Obey precautions for handling electrostatic-sensitive devices.

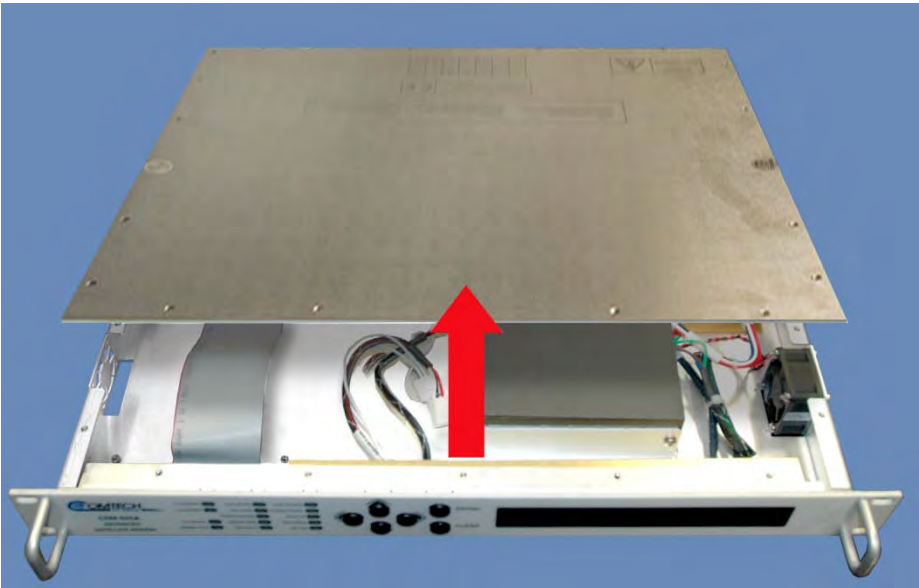

This procedure differs if your CDM-625A is already equipped with the Optional IP Packet Processor. Make sure to follow all steps carefully and note this exception to the procedure when performing your upgrades.

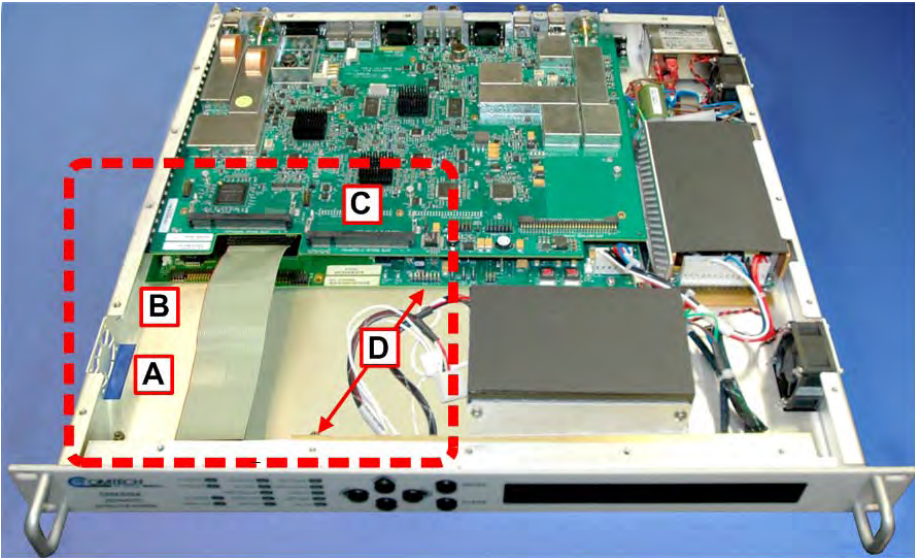

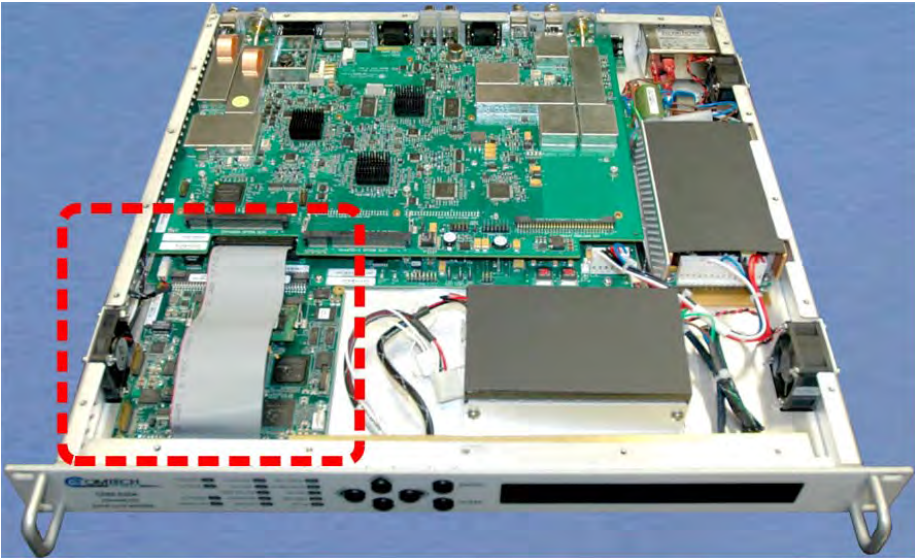
Step	Task
1	<p>Turn off the CDM-625A and disconnect the modem's power cord from its power source.</p> <p>Next, use the screwdriver to remove the top cover mounting hardware. Remove the cover from the CDM-625A chassis.</p> <p>IMPORTANT: Be sure to retain the top cover mounting hardware for cover re-installation once you have installed the VersaFEC-2 Field Upgrade Kit.</p> <p>If present, remove the fan hole cover plate and mounting hardware and discard.</p> 

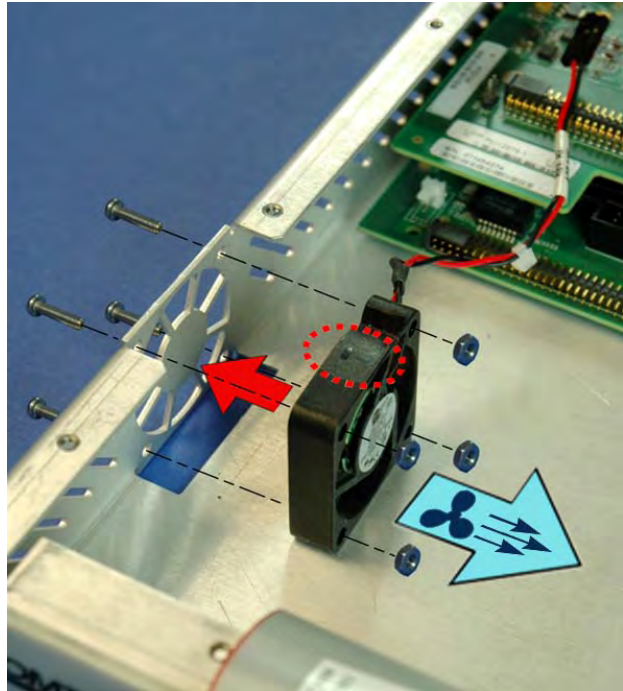
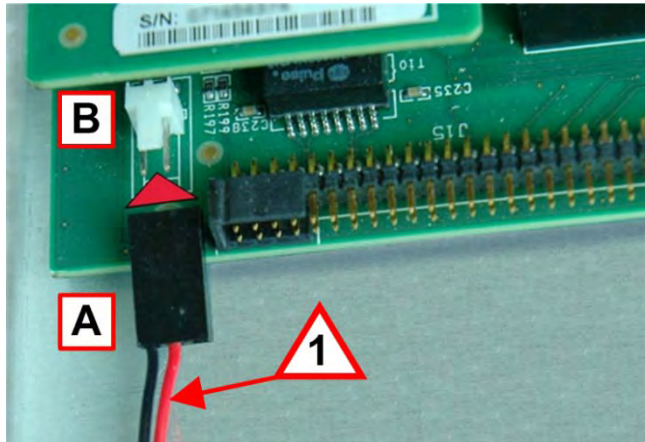
Step	Task	
2	<p>The illustration at right identifies the upgrade locations within the chassis for:</p> <ul style="list-style-type: none"> • (A) Installation of the fan into the chassis; • (B) Plug-in of the fan power cable into the CDM-625A's framing board; • (C) Assembly of the VersaFEC-2 Option Card onto the CDM-625A's modem board; • (D) Assembly of the Air Baffle to the chassis floor. 	 <p>The photograph shows the internal components of the CDM-625A chassis. A red dashed box highlights the area where the fan assembly is installed. Four specific locations are marked with red boxes and labeled A, B, C, and D. Label A points to the fan assembly on the chassis floor. Label B points to the fan power cable being plugged into the framing board. Label C points to the VersaFEC-2 Option Card being assembled onto the modem board. Label D points to the Air Baffle being assembled to the chassis floor.</p>
3	<p> If the optional IP Packet Processor Kit (CEFD P/N KT-0000176) has already been installed into the CDM-625A Chassis, then it is not necessary to install the kit fan assembly and its mating hardware.</p> <p> Appendix L. IP PACKET PROCESSOR OPTION (Sect. L.5 IP Packet Processor Field Upgrade Procedure)</p> <p>You may proceed to Step 6 to continue with the field upgrade procedure..</p>	 <p>The photograph shows the internal components of the CDM-625A chassis. A red dashed box highlights the area where the fan assembly is installed, indicating that this step is not necessary if the IP Packet Processor Kit is already installed.</p>

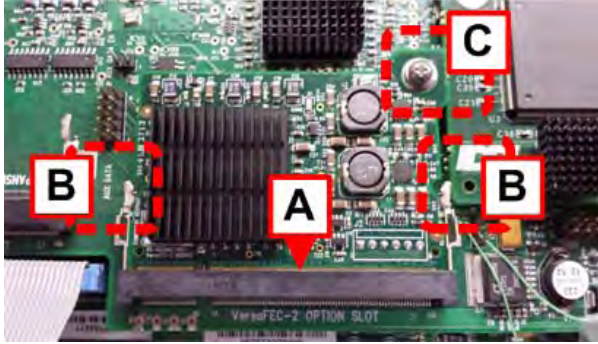
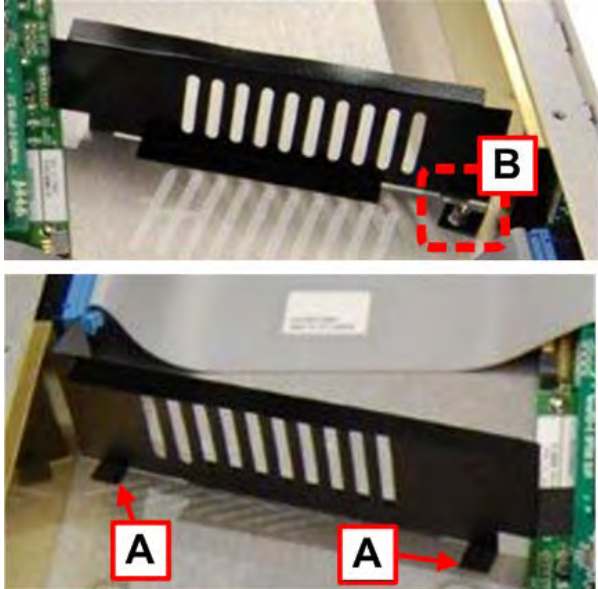
Step	Task	
4	<p>Use the screwdriver and pliers, as needed, to install the fan (CEFD P/N PL-0000449) and fan guard (CEFD P/N FN/FGDC12V01) securely into the chassis with the provided mounting hardware (4X CEFD P/N HW/4-40X3/4PH 4-40 x 3/4 pan head screws <i>and</i> 4X CEFD P/N HW/440HXNUTLOC 4-40 locking hex nuts) at the designated location.</p> <p>IMPORTANT: Refer to the arrow icons imprinted on the fan housing when installing the fan, to ensure that:</p> <ul style="list-style-type: none">• The air flow is directed into the chassis during operation <i>and</i>• The fan power cable is routed towards the power connector on the modem's framing board.	
5	<p>Use needle-nose pliers as needed to plug the fan power cable receptacle (A) into the mating connector on the modem's framing board (B).</p> <p>IMPORTANT NOTE 1: Note the orientation of the fan's power cable receptacle and wiring to the mating connector and its pins on the modem's framing board.</p>	

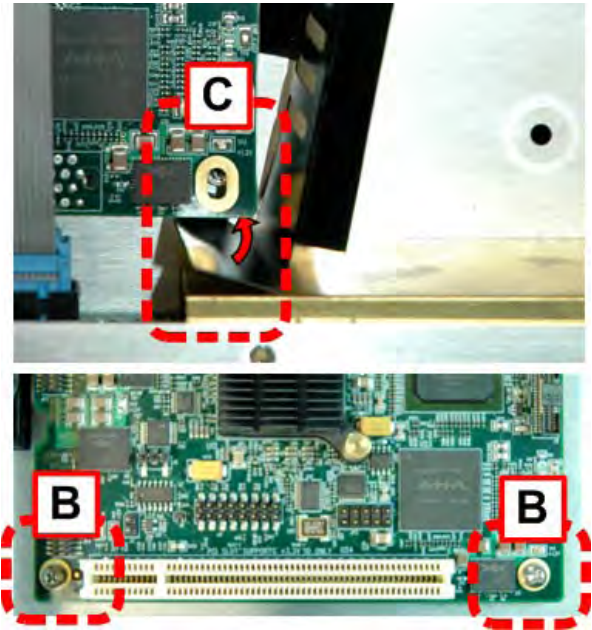
Step	Task	
6	<p>(A) Prepare the VerseFEC-2 Option Card for installation by aligning its connector with the mating receptacle on the modem board.</p> <p>Plug the card firmly into the receptacle – take care not to damage any top-mounted components. Similarly, be sure not to damage the bottom of the card during this task.</p> <p>(B) You have secured the card into operating position once the spring-loaded capture tabs, located at either side of the card, snap into place.</p> <p>(C) Use the screwdriver to secure the provided card mounting screw (CEFD P/N HW/SEM4-40X1/4PH) to its mating mounting boss.</p>	
7	<p>You have two options for installing the Air Baffle. Follow this step only if your modem is NOT equipped with the optional IP Packet Processor.</p> <p>(A) Peel the adhesive protective paper off the bottom of the mounting tabs and position the air baffle as shown.</p> <p>(B) Slip the retainer tab over the right-hand IP Packet Processor mounting boss. Secure all tabs to the chassis floor.</p>	

Step	Task	
8	<p>Follow this step if your modem IS equipped with the optional IP Packet Processor card:</p> <p>(A) Peel the adhesive protective paper off the bottom of the mounting tabs and position the air baffle as shown in Step 7(A).</p> <p>(B) Use the screwdriver to remove the IP Packet Processor's mounting screws (the front panel control ribbon is not shown for clarity).</p> <p>(C) Lift up the front edge of the IP Packet Processor card slightly up and away from its mounting bosses. Take care not to damage the card or loosen its connection to the framing board. Then, slip the Air Baffle retainer tab under the right-hand corner of the IP Packet Processor card, over and onto the (right-hand) mounting boss. Push the tab down onto the boss until it makes contact with the chassis floor.</p> <p>(D) Use the screwdriver to re-secure the IP Packet Processor card mounting screws to their mounting bosses.</p>	

Step	Task
9	<p>Use the screwdriver to reinstall the top cover onto the CDM-625A chassis with its existing mounting hardware.</p> <p>Plug the modem's power cord back into its power source.</p> 
10.	<p>The CDM-625A VersaFEC-2 Option Card upgrade is now complete. You may turn on and resume use of the modem. Before continuing, it is important that you make sure you are running the latest available firmware, and that you have activated the necessary VersaFEC-2 FAST options.</p> <p> • Chapter 4. UPDATING FIRMWARE • Chapter 5. FAST ACTIVATION PROCEDURE</p>

Appendix N. IP SUB-MUX

N.1 Overview

Subsystem Multiplex – referred to throughout this manual as **Sub-Mux** – is a secondary framing structure that combines IP traffic with any currently available combination of framing and interface type (excluding IP itself). The composite data rate to the modulator and from the demodulator is referenced to the primary, non-IP interface rate by a specific ratio selected by the user.

N.2 Available Ratios

The IP portion of the modem traffic can be either smaller or larger than the primary interface by the following ratios:

Ratio	IP Portion of Modem Traffic
1/59	IP traffic is one-fifty-ninth the primary
1/39	IP traffic is one-thirty-ninth the primary
1/19	IP traffic is one-nineteenth the primary
1/9 or 9	IP traffic is one-ninth the primary, or 9 times the primary
1/8 or 8	IP traffic is one-eighth the primary, or 8 times the primary
1/7 or 7	IP traffic is one-seventh the primary, or 7 times the primary
1/6 or 6	IP traffic is one-sixth the primary, or 6 times the primary
1/5 or 5	IP traffic is one-fifth the primary, or 5 times the primary
1/4 or 4	IP traffic is one-fourth the primary, or 4 times the primary
2/7 or 7/2	IP traffic is two-sevenths the primary, or 3.5 times the primary
1/3 or 3	IP traffic is one-third the primary, or 3 times the primary
2/5 or 5/2	IP traffic is two-fifths the primary, or 2.5 times the primary
3/7 or 7/3	IP traffic is three-sevenths the primary, or 2.33→ times the primary
1/2 or 2	IP traffic is one-half the primary, or 2 times the primary
3/5 or 5/3	IP traffic is three-fifths the primary, or 1.66→ times the primary
2/3 or 3/2	IP traffic is two-thirds the primary, or 1.5 times the primary
3/4 or 4/3	IP traffic is three-fourths the primary, or 1.33→ times the primary
4/5 or 5/4	IP traffic is four-fifths the primary, or 1.25 times the primary
1/1	IP traffic equals the primary

This gives you 34 ratios from which to choose. If framing is on, the overhead associated with the selected frame structure is applied to the primary data only, and the IP ratios above are fractions of the framed primary data.

IP ratios that put the composite rate above the maximum data rate of the modem cannot be selected. For example if the primary rate is 8192.000 kbps and the maximum rate of the modem was 25000.000 kbps, then a ratio above "2" cannot be selected. Also, if Sub-Mux is **on** and the primary rate is raised so the composite rate goes above the maximum of the modem, then the IP ratio will be lowered so that the composite rate stays below the maximum.

N.3 Data Rate vs. Composite Rate



Sect. 6.2.1.3 CONFIG: Tx or Sect. 6.2.1.4 CONFIG: Rx (Chapter 6. FRONT PANEL OPERATION)

Without Sub-Mux, the **CONFIG: Tx** and **CONFIG: Rx** front panel menu screens display the modem's transmit and receive data rates, which refer to the terrestrial rate of the primary interface type. Additions to the primary data due to framing are not shown, but are reflected in the displayed symbol rates.

Once Sub-Mux is enabled, the data rate display is replaced with the composite rate. This is the sum of the primary interface's data rate – which now includes framing overhead – and the IP rate at the selected ratio. The later is displayed by itself as IP INFO Rate under the **CONFIG: Tx → Tx Data Rate** or **CONFIG: Rx → Rx Data Rate** submenu. Note that Reed-Solomon overhead, if enabled, is also included in the composite rate calculation.

Example – For a G.703 E1 primary interface, with a 4/5 Sub-Mux ratio selected:

Unframed

Primary data rate = 2048.000 kbps

IP info rate = $2048 \times \frac{4}{5} = 1638.400$ kbps

Composite rate = $2048 + 1638.4$ or $2048 \times \frac{9}{5} = 3686.400$ kbps

Add ESC++ framing (added to E1 path only)

Data rate with overhead = $2048 \times \frac{29}{27} = 2199.703$ kbps

IP info rate = $2199.703 \times \frac{4}{5} = 1759.762$ kbps

Composite rate = $2199.703 + 1759.762$ or $2199.703 \times \frac{9}{5} = 3959.466$ kbps

Add Reed-Solomon FEC (added after Sub-Mux)

Composite rate = $3959.466 \times \frac{126}{112} = 4454.400$ kbps

The Sub-Mux frame does contain a very small overhead required for acquisition and identification of primary vs. IP data: As this overhead is taken from the "IP info rate" rather than the primary data rate, actual IP throughput will be slightly reduced.

Appendix P. OPEN NETWORK OPERATIONS

P.1 Overview

This appendix summarizes the functionality and specifications of the IBS, Drop and Insert (D&I), and IDR Open Network framing modes.

P.2 IBS

Primary Data Rates Supported	
G.703	1544, 2048, 6312 and 8448 kbps SD, RD
EIA-422, V.35, LVDS	N x 64 kbps SD, RD (up to 8448 kbps)
ADPCM Audio (2 Channels)	64 kbps only, full duplex

Engineering Service Channel	
Earth Station-to-Earth Station Channel	EIA-232 data synchronous at 1/480 of the primary data EIA-232 data asynchronous at 1/2000 of the primary data

High Rate Engineering Service Channel	
ESC Data Interface Type	Async – configurable asynchronous character format, EIA-232 at up to 1/20 th of primary data rate
ESC Data Rate	Example: 2400 baud at 64 kbps

Faults and Alarms	
Satellite Backward Alarm	1 (per IESS-309)
Receive BWA Output	Enabled onto terrestrial secondary alarm

P.2.1 IBS Clock/Data Recovery and De-jitter

This feature performs clock and data recovery on the G.703 format. Clock de-jitter and data encoding/decoding is done as with the IDR configuration.

P.2.2 IBS Framing

IBS Framing multiplexes/demultiplexes the primary data in compliance with the standard IESS-309 overhead ratio of 1/15 (4 overhead bytes per 60 data bytes) and provides the rate exchanged transmit clock to the modulator portion of the base modem.

P.2.3 IBS Engineering Service Channel

The IBS Engineering Service Channel provides bi-directional processing of the components of the ESC channel, including the ASYNC or SYNC EIA-232 data channel, and fault/alarm indications.

Alternately, a high-rate ESC channel – at up to 1/20th of the primary data rate – is available, using Async EIA-232 format.

P.2.4 IBS Scrambling

IBS Scrambling provides the synchronous scrambling/descrambling of the satellite-framed data specified in IESS-309. Base modem scrambling/descrambling is disabled in this mode.

P.3 Drop and Insert (D&I)

Primary Data Rates Supported	
G.703, EIA-422, V.35 and Serial LVDS	1544 kbps SD, RD, DDO, IDI 2048 kbps SD, RD, DDO, IDI
Satellite Data Rates Supported (all have 16/15 overhead)	N x 64 kbps N = 1, 2, 3, 4, 5, 6, 8, 10, 12, 15, 16, 20, or 24 (T1) N = 1, 2, 3, 4, 5, 6, 8, 10, 12, 15, 16, 20, 24, or 30 (E1-CCS) N = 1, 2, 4, 6, 8, 12, 16, 24, 30 (E1-CAS)
Terrestrial Framing Supported	G.732/G.733, G.704
Satellite Overhead Rate	16/15 of data rate per IESS-308 Rev. 6 and IESS-309 Rev. 3, or higher
Timeslot Selection Range	1 to 24 (all T1 modes) 1 to 30 (E1-CAS and E1-CCS) Arbitrary order, non-contiguous available
Plesiochronous Buffer Sizes	Selectable size of 64 to 262,144 bits, in 16-bit steps (with added limitations for G.704 frame boundaries)
Buffer Clock Reference	Derived from Insert Data In (Insert Clock) External, RX (satellite) or TX (Terrestrial)

Asynchronous Engineering Service Channel	
ESC Data Interface Type	EIA-232, Asynchronous
ESC Data Rate	1/2000 of primary data rate
ESC Data Circuits Supported	SD, RD, DSR

Synchronous Engineering Service Channel	
ESC Data Interface Type	EIA-232, synchronous to primary data
ESC Data Rate	1/480 of primary data rate
ESC Data Circuits Supported	SD, ST, RD, RT, DSR

Faults and Alarms	
Satellite Backward Alarm	1 (per IESS-309)
Receive BWA Output	Enabled onto terrestrial secondary alarm

P.3.1 D&I Primary Data Interfaces

When configured for D&I operation, multiplexing/demultiplexing follows the IBS satellite frame structure and ESC features, but with the following changes:

- It accepts and outputs primary data through the G.703 connectors.
- The data rate must be at T1 or E1 rates only. This includes additional links for Drop Data Out and Insert Data In.
- Clock recovery, dejitter, and encoding/decoding are performed as before.

P.3.2 D&I Framing

The IBS satellite framing/deframing is applied only to selected time slots of the data's G.704 terrestrial structure.

P.4 IDR

Primary Data Rates Supported	
G.703	1544 kbps SD, RD
EIA-422 (Replaces 8K Overhead)	2048 kbps SD, RD
V.35 (Replaces 8K Overhead)	6312 kbps SD, RD
	8448 kbps SD, RD

Engineering Service Channel	
ESC Audio	2 duplex ADPCM channels
Audio Encoding	CCITT G.721
Audio Interface Type	600Ω transformer-balanced 4-wire
Audio Input Level	Nominal Input : 0dBm0 (-3dBm, 600Ω) Adjustment range: -6 to +8 dB, 2 dB steps
Audio Output Level	Adjustment range: -6 to +8 dB, 2 dB steps
Audio Filtering	Internal 300 to 3400 Hz input and output
ESC Data Interface Type	EIA-422
ESC Data Rate	8 kbps, also 64 kbps if ADPCM audio is not used
ESC Data Circuits Supported	SD, ST, RD, RT, Octet in, Octet out
Data Signal Phasing	Per EIA-449, data changes on the rising clock transition, is sampled on the falling clock edge
Octet Timing	Octet high with every 8 th bit, aligns with frame bit d8

Faults and Alarms	
Backward Alarms Supported	4 input, 4 output
Backward Alarm Inputs	1 kΩ pull up to ground, set high to activate.
Backward Alarm Outputs	Form C Relay, N/O, N/C, Com

P.4.1 IDR Primary Data Interfaces

When configured for IDR operation, the board performs these functions:

- It receives and performs clock and data recovery on incoming G.703 T1 and E1 pseudo-ternary data.
- It performs clock dejitter per G.823 and G.824, and also accomplishes any data decoding (AMI, B8Z5, or HDB3) required per G.703.
- It performs IDR Framing.
- It multiplexes in compliance with the standard IESS-308 96 kbps ESC overhead onto the data and provides both the data and rate-exchanged clock to the modulator portion of the base modem.
- It performs the corresponding demultiplexing of Rx satellite data received from the demodulator portion of the modem. Resulting G.703 data is optionally encoded (AMI, B8Z5, or HDB3) before being output.

P.4.2 IDR Engineering Service Channel

- It provides for bidirectional processing of the components of the ESC channel, including the ADPCM audio channels, 8 kbps data channel, and fault indications specified by IESS-403 and IESS-308.
- It provides the option of using the ADPCM portion of the satellite overhead for a single 64 kbps ESC data channel in addition to (and with the same format as) the 8 kbps data channel.
- When using G.703 format for the primary IDR data path, the P3B primary data interface (25-pin) is used for the 8kbps overhead channel. If EIA-422 or V.35 is used, P3B becomes the primary interface and the 8kbps channel is unavailable.

Appendix Q. OFFSET QPSK OPERATION

OQPSK is the acronym for **Offset Quadrature Phase Shift Keying** modulation. OQPSK is a variation of normal QPSK that is offered in the CDM-625A Advanced Satellite Modem. Normal band-limited QPSK produces an RF signal envelope that necessarily goes through a point of zero amplitude when the modulator transitions through non-adjacent phase states. This is not considered to be a problem in most communication systems, as long as the entire signal processing chain is linear.

However, when band limited QPSK is passed through a non-linearity (e.g., a saturated power amplifier), there is a tendency for the carefully filtered spectrum to degrade. This phenomenon is termed *spectral regrowth*, and at the extreme (hard limiting), the original unfiltered $\sin(x)/x$ spectrum would result. In most systems, this would cause an unacceptable level of interference to adjacent carriers, and would cause degradation of the BER performance of the corresponding demodulator.

To overcome the problem of the envelope collapsing to a point of zero amplitude, Offset QPSK places a delay between in-phase (I) and quadrature (Q) channels of exactly 1/2 symbol. Now, the modulator cannot transition through zero when faced with non-adjacent phase states; the result is that there is far less variation in the envelope of the signal, and non-linearities do not cause the same level of degradation.

The demodulator must realign the I and Q symbol streams before the process of carrier recovery can take place. For various reasons, this makes the process of acquisition more difficult. In the CDM-625A, the two consequences of this are as follows:

- 1) Demodulator acquisition may be longer than standard QPSK, especially at low symbol rates.
- 2) The acquisition threshold is slightly higher than for normal QPSK. This effect is only an issue for LDPC Rate 1/2 and TPC Rate 21/44 code rates, where the E_b/N_0 values are typically less than 2 dB. In this case, the acquisition and tracking threshold is approximately 1dB higher than for QPSK.

Appendix R. QUALITY OF SERVICE (QoS)

R.1 Overview

Quality of Service (QoS) enables a network to use WAN bandwidth more efficiently by managing delay, jitter (delay variation), throughput, and packet loss.

The CDM-625A Advanced Satellite Modem incorporates two Per Hop Behavior (PHP) QoS methods – **Layer 2 QoS** and **Layer 3 QoS**:

- **Layer 2 QoS** is available on the CDM-625A by default when the optional IP Packet Processor card is either **not installed**, or is **installed** but **disabled**. Layer 2 QoS is based on OSI model Layer 2 header parameters such as IEEE 802.1q VLAN priority field, and is also based on the CDM-625A's physical Ethernet port.
- **Layer 3 QoS** requires the optional IP Packet Processor card to be **installed** and **enabled**, and the Advanced QoS FAST option must be purchased and activated. Layer 3 QoS is based on OSI model Layer 3 to Layer 7 protocol header parameters.

R.1.1 QoS Terminology

- **Latency** – Latency is the amount of delay that is measured, in milliseconds, from the Ethernet interface of the near-end modem to the Ethernet interface of the far-end modem.
- **Jitter** – Jitter is the amount of variation that is measured, in milliseconds, between two consequent frames at the receiving end.

R.2 Layer 2 QoS



See Chapter 6. FRONT PANEL OPERATION for complete information about using this interface.

Layer 2 QoS is implemented on System on Chip (SoC) hardware having a total queue memory of 1 Mbits (128 Kilobytes). This limits traffic burst size to no more than 128 Kilobytes. The Layer 2 QoS system has four queues and four priorities; each queue is assigned to each priority with a total of 128 KB for all four queues.

A Layer 2 QoS system uses the strict priority-scheduling algorithm – the higher the priority number, the higher the priority. For example, a Priority 4 queue schedules and drains before a Priority 3 queue; similarly, Priority 3 packets will schedule and drain before Priority 2 packets; Priority 2 packets schedule and drain before Priority 1 packets. Priority 1 queue packets, therefore, will schedule and drain only if QoS bandwidth is available after serving the three higher-priority packet queues. *High priority queues may starve low priority queues.*

Three modes of Layer 2 QoS are available: **Port-based**, **VLAN-based**, or **Port- and VLAN-based**.

R.2.1 Modem Tx Data Rate vs. QoS Tx Data Rate

Modem Tx data rate can be set in 1 Kbps step size (resolution). In an idle situation, QoS Tx bandwidth shall be the same as the modem’s Tx bandwidth. However, due to hardware limitations the Layer 2 QoS Tx bandwidth can be set near to the modem’s data rate. **Table R-1** lists the step sizes for both CDM-625A hardware versions.

Note that the Layer 2 QoS scheduling algorithm runs on the basis of QoS Tx data rate; however, the modem can send only the modem Tx data rate. In the event of difference between QoS data rate and modem Tx data rate, after QoS scheduling the modem further clips the input data rate to the modem Tx data rate without considering the scheduling priorities.

Table R-1. Modem Tx Data Rate vs. QoS Tx Data Rate (Hardware-limited)

Modem Tx Data Rate	QoS Tx Data Rate
Less than 128 Kbps	64 Kbps steps
128 Kbps to 256 Kbps	64 Kbps steps
256 Kbps to 512 Kbps	64 Kbps steps
512 Kbps to 1 Mbps	64 Kbps steps
1 Mbps to 2 Mbps	1 Mbps steps
2 Mbps to 4 Mbps	1 Mbps Steps
4 Mbps to 8 Mbps	1 Mbps steps
8 Mbps to 25 Mbps	1 Mbps steps

QoS Example 1

QUESTION: *If the modem Tx data rate is set to 180 Kbps, then what is the QoS Tx data rate?*

ANSWER:

The QoS Tx data rate can be set from 64 Kbps to 1 Mbps, in 64 Kbps steps. If the 180 Kbps modem Tx data rate is not in 64 Kbps step size, then the QoS Tx data rate will be the next 64 Kbps, which is 196 Kbps.

R.2.2 Flow Control

In Layer 2 QoS mode, the CDM-625A supports Ethernet-based pause frame control (IEEE 802.3). Flow control can be enabled or disabled independently in any of the LAN ports.

R.2.3 Port-based Layer 2 QoS

When selecting Port-based Layer 2 QoS, each port's priority is configurable to a QoS queue priority of 1 (lowest) to 4 (highest). In this mode, irrespective of traffic type, all traffic ingress on a particular port is treated with the priority assigned to that port.

In the event any port is overdriven with ingress traffic, if there is insufficient queue memory to store the packet, then the packet will be dropped and drop stats will be incremented against that port.

QoS Example 2

- **Port-based** Layer 2 QoS mode is selected.
- Port Layer 2 QoS Priorities are set as follows:
 - Port 1 priority is set to 1;
 - Port 2 priority is set to 2;
 - Port 3 priority is set to 3;
 - Port 4 priority is set to 4.
- The modem data rate is set to 1 Mbps.
- The ingress traffic on each port is set to 250 Kbps.

QUESTION: What is the total output data rate and what is individual ports output data rate?

ANSWER:

- Based on **Table R-1** for a modem Tx bandwidth of 1 Mbps, the QoS output bandwidth is set to 1 Mbps.
- Total Input data rate is 4X 250 Kbps = 1 Mbps
- The output Data rate = 1 Mbps
- Each ports data rate = 250 Kbps

QoS Example 3

- **Port-based** Layer 2 QoS mode is selected.
- Port Layer 2 QoS Priorities are set as follows:
 - Port 1 priority is set to 1;
 - Port 2 priority is set to 2;
 - Port 3 priority is set to 3;
 - Port 4 priority is set to 4.
- The modem data rate is set to 2500 Kbps.
- The ingress traffic on Ports 1 and 2 are set to 2 Mbps.
- The ingress traffic on Port 3 is set to 800 Kbps.
- The ingress traffic on Port 4 is set to 500 Kbps.

QUESTION: What is the total output data rate and what are the individual port output data rates?

ANSWER:

- Based on **Table R-1** for a modem Tx bandwidth of 2.5 Mbps, the QoS output bandwidth is set to 3 Mbps.
- Since the modem Tx bandwidth and QoS output data rates are not the same, after Layer 2 QoS prioritization the modem will further limit the output data rate to the Tx bandwidth of the mode. The individual port data rates will henceforth be trimmed (normalized) to the data rate of the modem Tx bandwidth without considering the priorities.

Port	L2 QoS Priority	Input Data Rate	QoS Output Data Rate	Remaining Data Rate* (After Serving the Priority Queue)	Output Data Rate
4	4	500 Kbps	500 Kbps	2500 Kbps	$500 \times (2.5/3) = 417$ Kbps
3	3	800 Kbps	800 Kbps	1700 Kbps	$800 \times (2.5/3) = 667$ Kbps
2	2	2 Mbps	1700 Kbps	0 Kbps	$1700 \times (2.5/3) = 1416$ Kbps
1	1	2 Mbps	0 Kbps	0 Kbps	0 Kbps
Total ►		5.3 Mbps	3 Mbps	0 Kbps	2.5 Mbps

*After Priority 4, even though the actual modem TX data rate is 2500 kbps, the QoS leftover data rate is still 2500 kbps since QoS bandwidth is 3000 kbps.

R.2.4 VLAN-based Layer 2 QoS

When selecting VLAN-based Layer 2 QoS, the priority field is extracted from the 802.1q VLAN tag as shown in **Figure R-1**. The VLAN tag priority field is 3 bits, so the 802.1q protocol supports eight priorities, from 0 to 7. However, because Layer 2 QoS has only four priorities as mentioned previously, as shown in **Table R-2** these eight VLAN priorities are automatically mapped to four internal priorities.

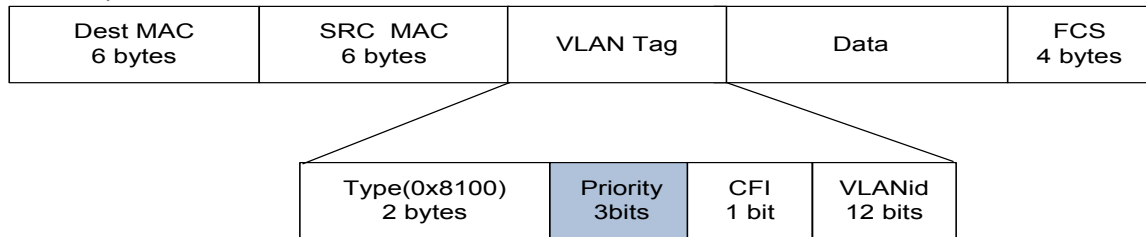

Figure R-1. IEEE 802.1q VLAN priority

Table R-2. 802.1q to Layer 2 QoS Priority Conversion

802.1q VLAN Priority Field	Layer 2 QoS Priority
7 (b111)	Priority 4
6 (b110)	
5 (b101)	Priority 3
4 (b100)	
3 (b011)	Priority 2
2 (b010)	
1 (b001)	Priority 1
0 (b000)	

Even though it is not necessary to configure multiple ports with VLANs, the VLAN QoS will not look in the port information when classifying the packets into queue.

Similar to the Port-based scheduler, VLAN-based QoS also observes strict priority-based scheduling. Should overdriving of VLAN priority traffic occur, the packet will be dropped and drop stats will be incremented against that port.



In case VLAN Q-in-Q (double VLAN tag), the L2 VLAN QoS considers first VLAN tag priority field only for traffic prioritization.

QoS Example 4

- 1) **VLAN-based** Layer 2 QoS mode is selected.
- 2) The modem data rate is set to 1 Mbps.
- 3) Four streams of VLAN ingress traffic is sent to the modem with VLAN Priorities set to 7, 5, 3, and 1, respectively.
- 4) The data rate for each stream is set to 500 Kbps.

QUESTION: *What is the total output data rate and what are the individual port output data rates?*

ANSWER:

- Based on **Table R-1** for a modem Tx bandwidth of 1 Mbps, the QoS output bandwidth is set to 1 Mbps.
- Total Input data rate is 4X 500 Kbps = 2 Mbps
- Based on **Table R-2**, the VLAN Priorities 7, 5, 3, and 1 are mapped, respectively, to L2 QoS Priorities 4, 3, 2, and 1.
- Since the modem Tx bandwidth and QoS output data rates are the same, there is no need for normalization.
- The data rate for each port is as follows:

VLAN Priority	L2 QoS Priority	Input Data Rate	QoS Output Data Rate	Remaining Data Rate (After Serving the Priority Queue)	Output Data Rate
7	4	500 Kbps	500 Kbps	500 Kbps	500 Kbps
5	3	500 Kbps	500 Kbps	0 Kbps	500 Kbps
3	2	500 Kbps	0 Kbps	0 Kbps	0 Kbps
1	1	500 Kbps	0 Kbps	0 Kbps	0 Kbps
Total ▶		2 Mbps	1 Mbps	0 Kbps	1 Mbps

QoS Example 5

- 1) **Port- and VLAN-based** Layer 2 QoS mode is selected.
- 2) Port Layer 2 QoS Priorities are set as follows:
 - Port 1 priority is set to 1;

- Port 3 priority is set to 3;
 - Ports 2 and 4 priorities are set to **trunk mode (native disabled)**.
- 3) The modem data rate is set to 4000 Kbps.
 - 4) The ingress traffic on Port 1 is set to 2 Mbps.
 - 5) The ingress traffic on Port 3 is set to 1600 Kbps.
 - 6) The ingress traffic on Port 2 is set to 2000 Kbps with a VLAN Priority of 1.
 - 7) The ingress traffic on Port 4 is set to 800 Kbps with a VLAN Priority of 7.

QUESTION: *What is the total output data rate and what are the individual port output data rates?*

ANSWER “A” – For HW Ver. Rev 2.1 and newer:

- Based on **Table R-1** for a modem Tx bandwidth of 4 Mbps, the QoS output bandwidth is set to 4 Mbps.
- Since the modem Tx bandwidth and QoS output data rates are the same, there is no need for normalization.
- Based on **Table R-2**, the VLAN Priorities 7 and 1 are mapped, respectively, to L2 QoS Priorities 4 and 1.
- The data rate for each port is as follows:

Port	VLAN Priority	L2 QoS Priority	Input Data Rate	QoS Output Data Rate = Modem Output Data Rate	Remaining Data Rate (After Serving the Priority Queue)
4	7 (b111)	4	800 Kbps	800 Kbps	3200 Kbps
3	N/A	3	1600 Kbps	1600 Kbps	1600 Kbps
2	1 (b001)	1	2 Mbps	800Kbps	800Kbps
1	N/A	1	2 Mbps	800 Kbps	800 Kbps
Total ▶			5.3 Mbps	4 Mbps	0 Mbps



- 1) **Layer 2 QoS can be enabled only when the optional Packet Processor is not enabled.**
- 2) **Layer 2 QoS is implemented on System on Chip (SoC) hardware with a total queue memory of 1 Mbits (128 Kbytes). Layer 2 QoS therefore cannot accept traffic bursts requiring more than 128 Kbytes of storage.**

R.3 Layer 3 QoS

Layer 3 QoS scheduling operates on modem Tx bandwidth with 1-byte resolution, so there is further trimming or clipping data rate after the QoS scheduler.

Layer 3 QoS is implemented with at least one 1-second burst at maximum data rate. So Layer 3 QoS can process much larger bursts than Layer 2 QoS.

Excluding the default queue, the Layer 3 QoS system has up to 32 QoS with 8 configurable priorities rules. The Layer 3 QoS system creates a separate queue for each rule to store the incoming stream of packets. (In this appendix, 'QoS rules' and 'QoS queues' are interchangeable).

Layer 3 QoS systems use a strict priority QoS scheduling algorithm. Layer 3 QoS priority numbers are *inverse* to Layer 2 QoS system numbers – the *lower* the priority number, the *higher* the priority. For example, a Priority 1 queue schedules and drains before a Priority 2 queue; similarly, Priority 2 packets will schedule and drain before Priority 3 packets, etc.

Layer 3 QoS systems incorporates WRED (Weighted Random Early Detection) based congestion avoidance algorithm in addition to tail drop.

Three modes of Layer 3 QoS are available: **MAX-Pri** (Max-Priority), **MIN-MAX** (Minimum-Maximum), and **DiffServ** (Differentiated Services).

R.3.1 Layer 3 QoS Max-Pri Mode

In Max-Pri mode, up to 32 QoS rules can be configurable using source IP subnet, destination IP subnet, source port range, destination port range, and protocol. For each created rule, you can also set the QoS treatments such as priority, limiting the maximum bandwidth, WRED enable or disable, and filter enable or disable.

When WRED is enabled for a specific queue, QoS randomly drops packets after reaching 50% of the QoS queue.

When the FILTER option is enabled for a rule, Layer 3 QoS provides the ability to filter the packet completely.

QoS Example 6

- 1) **Max-Pri** Layer 3 QoS mode is selected.
- 2) Modem Tx bandwidth is set to 2048 Kbps (E1 rate).
- 3) The Max-Pri QoS rules are configured as follows:

Index	Protocol	VLAN Range	TOS	Src IP/ mask	Dest IP/ mask	Min Src Port	Max Src Port	Min Dst Port	Max Dst Port	Max BW	Priority	Filter	WRED
1	UDP	0-4094	255	***/*	***/*	0	65535	0	65535	644	1	N	N
2	TCP	0-4094	255	***/*	***/*	0	65535	0	65535	99999	2	N	N
3	HTTP	0-4094	255	***/*	***/*	0	65535	0	65535	99999	3	N	N
4	Def	0-4094	255	****/*	***/*	0	65535	0	65535	99999	9	N	N

4) The input data streams are as follows:

Stream	Protocol	VLAN Range	TOS	Src IP	Dest IP	Src Port	Dest Port	Stream Data Rate
1	UDP	0-4094	255	***/*	***/*	***	***	1024
2	TCP	0-4094	255	***/*	***/*	***	***	1024
3	HTTP	0-4094	255	***/*	***/*	***	***	1024
4	IP	0-4094	255	***/*	***/*	***	***	64

QUESTION: What are the total output data rates and the individual stream data rates?

ANSWER: The individual stream data rates are as follows:

QoS Rule	Layer 3 QoS Priority	Input Data Rate	QoS Output Data Rate	Remain Data Rate (After Serving the Priority Queue)
1	1	1024 Kbps	644 Kbps due to max clipping	1404 Kbps
2	2	1024 Kbps	1024 Kbps	380 Kbps
3	3	1024 Kbps	380Kbps	0 Kbps
4	9	64 Kbps	0	0 Kbps
Total ►		3136 Kbps	2048 Kbps	0 Kbps

R.3.2 Layer 3 QoS Min-Max Mode

In Min-Max mode, up to 32 QoS rules can be configurable using source IP subnet, destination IP subnet, source port range, destination port range, and protocol. For each created rule, you can also set the QoS treatment, such as guaranteed minimum bandwidth, maximum clipping bandwidth, WRED enable or disable, and filter rule.

When WRED is enabled for a specific queue, QoS randomly drops packets after reaching 50% of the QoS queue.

When the FILTER option is enabled for a rule, Layer 3 QoS provides the ability to filter the packet completely.

QoS Example 7

- 1) **Min-Max** Layer 3 QoS mode is selected.
- 2) Modem Tx bandwidth is set to 20 Mbps.
- 3) The Min-Max QoS rules are configured as follows:

Index	Protocol	VLAN Range	TOS	Src IP/ mask	Dest IP/ mask	Min Src Port	Max Src Port	Min Dst Port	Max Dst Port	Min BW	Max BW	Priority	Filter	WRED
1	UDP	0-4094	255	***/*	***/*	0	65535	0	65535	2500	4000	1	N	N
2	TCP	0-4094	255	***/*	***/*	0	65535	0	65535	2500	99999	2	N	N
3	HTTP	0-4094	255	***/*	***/*	0	65535	0	65535	0	99999	3	N	N
4	Def	0-4094	255	****/*	***/*	0	65535	0	65535	0	9999	9	N	N

- 4) The input data streams are as follows:

Stream	Protocol	VLAN Range	TOS	Src IP	Dest IP	Src Port	Dest Port	Stream Data Rate
1	UDP	0-4094	255	***/*	***/*	***	***	10000 Kbps
2	TCP	0-4094	255	***/*	***/*	***	***	5000 Kbps
3	HTTP	0-4094	255	***/*	***/*	***	***	7000 Kbps
4	DEF	0-4094	255	***/*	***/*	***	***	10000 Kbps

QUESTION: *What are the total output data rates and the individual stream data rates?*

ANSWER:

- In Min-Max QoS mode, other than the default rule, which is configured as Priority 9, all QoS rules are configured as Priority 8.

- In this mode, the minimum bandwidth for all rules – the excluding the default rule – will be served *first in round robin fashion*.
In this example, the total minimum BW for Rules 1 and 2 is 5000 Kbps. Since the total bandwidth is 20 Mbps, it has enough bandwidth to serve.
- After serving the minimum bandwidth, the leftover bandwidth is 15 Mbps (20,000 Kbps– 5000 Kbps).
- Leftover bandwidth will be served among all rules in round robin fashion until it hits maximum bandwidth limitations.
- Each rule’s bandwidth is $15/3 = 5000$ Kbps.
- Since Rule 1 maximum clipping was set to 4000 Kbps, and minimum bandwidth has already taken 2500 bytes, it will use 1500 Kbps more before reaching the maximum clipping. The leftover 3500 Kbps ($5000-1500=3500$) is again given to the main pool.
- Rule 2 does not have enough traffic coming in, so it will use only 2500 kbps ($5000-2500$); the remaining bandwidth ($5000-2500=2500$) is again given to the main pool.
- Rule 3’s input stream is 7000 bytes; it will take its share of the 5000 allocation. Still, it needs $7000-5000=2000$).
- After serving the fair share, the total leftover bandwidth is 6000 kbps ($3500+2500=6000$).
- Since Rule 3 needs the bandwidth, the leftover bandwidth is applied to that rule.
- After serving Rule 3, the leftover bandwidth 4000 Kbps will be applied to the default queue.
- The default rule will see the data rate of 4000 Kbps.

The individual rule’s data rates are as follows:

QoS Rule	Layer 3 QoS Priority	Input Data Rate	QoS Output Data Rate
1	1	10000 Kbps	4000 Kbps
2	2	5000 Kbps	5000 Kbps
3	3	7000 Kbps	7000 Kbps
4	9	10000 Kbps	4000 Kbps
Total ►		32000 Kbps	20000 Kbps

R.3.3 Layer 3 QoS DiffServ Mode

Layer 3 DiffServ QoS is fully compliance to RFC standards. When the Layer 3 QoS mode is set to DiffServ, the system automatically configures the rules with DSCP code points, priority values, and WRED. You can only configure the service rate and drop precedence levels for Assured Forwarding (ASFD) classes.

R.3.3.1 Layer 3 QoS Congestion Avoidance

The Layer 3 QoS system supports Weighted Random Early Detection (WRED) based congestion avoidance. WRED can be enable or disabled on any queue. When WRED is disabled, upon overdriving the queue the packets will be tail dropped.

QoS Example 8

- 1) **DiffServ** Layer 3 QoS mode is selected.
- 2) The modem Tx bandwidth is set to 10 Mbps.
- 3) The data rate of the modem drops down from 10 Mbps to 8.7 Mbps due to EbNo.
- 4) The input data streams to the modem are the same as those of QoS Example 7.

QUESTION: *What is the total output data rate and what are the individual port output data rates?*

ANSWER:

- The Layer 3 QoS system first drains Priority 1 traffic. Since the management data stream is only 200 Kbps, after serving Priority 1 traffic, QoS still has 9.8 Mbps ($10.0 - 0.2 = 9.8$).
- QoS next drains Priority 2's 800 Kbps traffic. After the end of the Priority 2 traffic, QoS still has 9 Mbps traffic available ($9.8 - 0.8 = 9$).
- Similarly, QoS walks through all priorities until it hits the ASFD classes:
 - The beginning of ASFD Classes QoS leftover bandwidth is 2 Mbps.
 - All ASFD classes have the same Priority of 7, with different service rates.
 - ASFD service rate is a Committed Information Rate (CIR), except serviced if bandwidth available after serving all high priority queues. In this case, 2 Mbps bandwidth is available, serving all service rates first. The total of all ASFD service rates are 1.6 Mbps, which is less than the 2 Mbps leftover bandwidth.
 - After serving the service rates, the leftover bandwidth is 400 Kbps. This 400 Kbps will be distributed to all ASFD classes equally in round robin fashion until either there is no more bandwidth, or the input streams have no data.

- The resulting individual data rates are as follows:

Stream	Priority	PHB / DSCP Code	Service Rate	Drop Precedence	Data Rate
Management	1	CS7 / b111000	200 Kbps	9.8 Mbps	200 Kbps
Networking Control	2	CS6 / b110000	800 Kbps	9.0 Mbps	800 Kbps
Voice	3	EXFD / b101110	1 Mbps	8.0 Mbps	1Mbps
Video	3	CS5 / b101000	4 Mbps	4.0 Mbps	4 Mbps
Data-1	4	CS4 / b100000	550 Kbps	3450 Kbps	550 Kbps
Data-2	5	CS3 / b011000	1450	2000 Kbps	1450 Kbps
Data-3	7	ASFD4 / b100010	1 Mbps	NA	100 + 100 Kbps
Data-4	7	ASFD3 / b011010	1 Mbps	NA	400 + 100 Kbps
Data-5	7	ASFD2 / b010010	1 Mbps	NA	500 + 100 Kbps
Data-6	7	ASFD1 / b001010	1 Mbps	NA	800 + 100 Kbps
Data-7	8	BE / bXXXXXX	2 Mbps	NA	0 Kbps
Total ►			14 Mbps	0 Kbps	10 Mbps

R.3.3.2 Layer 3 QoS List of Supported RFCs (Requests for Comment)

RFC No.	Description
2474	"Definition of the Differentiated Services Field (DS Field) in the IPv4 and IPv6 Headers" Nichols, K., Blake, S., Baker, F. and D. Black, December 1998
2475	"An Architecture for Differentiated Services" Blake, S., Black, D., Carlson, M., Davies, E., Wang, Z. and Weiss, W., December 1998
2597	"Assured Forwarding PHB" Heinanen, J., Baker, F., Weiss, W. and J. Wrocklawski, June 1999
2598	"An Expedited Forwarding PHB" Jacobson, V., Nichols, K. and K. Poduri, June 1999

R.4 QoS with ACM (Adaptive Coding and Modulation)

When ACM is enabled, the modem is configured with symbol rate. However, while the QoS system recognizes data rate, both Layer 2 QoS and Layer 3 QoS operate on data rate. Therefore, while the symbol rate will be constant in ACM mode, the data rate will *not* be constant. As a result, the modem's data rate can vary "on-the-fly" based on the EbNo. The data rate can be more or less than when QoS was first configured, or when the modems first boots.

R.4.1 Maximum Clipping

Due to ACM, when in QoS Max-Pri mode and the data rate's available bandwidth exceeds the maximum clipping rate, the QoS system limits the output rate of that rule to configured maximum clipping rate.

When the available data rate is less than the maximum clipping rate, the QoS system has nothing to clip, since it has not exceeded the defined maximum bandwidth rate.

R.4.2 Minimum Data Rate

Due to ACM, when the data rate's available bandwidth exceeds the minimum data rate (per QoS Min-Max and DiffServ modes' ASFD classes), the QoS system operates as normal; since the minimum has been met, the available bandwidth is shared among all other same priorities in round robin fashion.

When the available data rate is less than the minimum data rate, then the QoS system shares equally among all same priority queues in a round robin fashion until either minimum bandwidth is met, or no more data is available to drain.

QoS Example 9

- 1) DiffServ Layer 3 QoS mode is selected.
- 2) ACM is enabled.
- 3) The data rate of the modem drops down from 10 Mbps to 8.7 Mbps due to EbNo.
- 4) Input data streams are the same as with **QoS Example 7** (see **Sect. R.3.2**).

QUESTION: *What will be the total data rate and what will be the individual data rates?*

ANSWER:

- After serving all high priority queues, only 500 Kbps is left for ASFD classes.
- This leftover bandwidth is less than the total minimum bandwidth; it must therefore share the residual 500 Kbps among all four ASFD classes equally - i.e., $500/4=175$ Kbps per class.

- Since ASFD 4 has the service rate 100 Kbps, the excess 75 Kbps will be given the other queues where the service rate not met.
- In this case the 75 Kbps again will share equally among ASFD3, ASFD2, and ASFD1 since these service rates were not met.
- The resulting individual data rate is as follows:

Stream	Priority	PHB / DSCP Code	Input Data rate	Leftover BW (After Serving the Queue)	QoS output Data rate
Management	1	CS7 / b111000	200 Kbps	9.8 Mbps	200 Kbps
Networking Control	2	CS6 / b110000	800 Kbps	9.0 Mbps	800 Kbps
Voice	3	EXFD / b101110	1 Mbps	8.0 Mbps	1Mbps
Video	3	CS5 / b101000	4 Mbps	4.0 Mbps	4 Mbps
Data-1	4	CS4 / b100000	550 Kbps	3450 Kbps	550 Kbps
Data-2	5	CS3 / b011000	1450	2000 Kbps	1450 Kbps
Data-3	7	ASFD4 / b100010	1 Mbps	NA	100 Kbps
Data-4	7	ASFD3 / b011010	1 Mbps	NA	175 + 25 Kbps
Data-5	7	ASFD2 / b010010	1 Mbps	NA	175 + 25 Kbps
Data-6	7	ASFD1 / b001010	1 Mbps	NA	175 + 25 Kbps
Data-7	8	BE / bXXXXXX	2 Mbps	NA	0 Kbps
Total ►			14 Mbps	0 Kbps	8.7 Mbps

Appendix S. TRANSMIT SPECTRUM FILTERING OPTIONS

S.1 Overview

The CDM-625 Advanced Satellite Modem offered the choices of 0.35 or 0.25 for Transmit Alpha Filter Rolloff Factor (Tx Alpha, or simply $Tx\alpha$). The CDM-625A Advanced Satellite Modem now provides the choices of 0.05, 0.10, 0.15, 0.20, 0.25, or 0.35.



See Sect. 1.4.1 Modulator (Chapter 1. INTRODUCTION) for detailed spectral density plots for all values of $Tx\alpha$.

S.2 Observations and Recommendations

- In a perfectly linear channel with tightly controlled RF carrier frequencies, there is no penalty when using tighter rolloffs (smaller $Tx\alpha$). The benefit of this is that more carriers can be fitted into a given amount of transponder bandwidth. You should, however, consider that in many cases, transponders are power limited, not bandwidth limited, leading to the conclusion that for power limited cases, tighter rolloffs do not provide an obvious benefit.

If, on the other hand, the assumptions of linearity and/or frequency stability are not true, then you should be aware of the potential degradations that can be caused by using lower values of $Tx\alpha$.

- As the rolloff decreases, the peak-to-average power ratio of the waveform increases, and if an SSPA (or any other element in the link) is approaching compression, the carrier will be more prone to spectral regrowth, and depending on the exact modulation type, this may cause additional degradation due to compression of outer constellation points (particularly with non-round constellations).

A White Paper that is to be published by Comtech EF Data after the initial release of the CDM-625A will offer precise guidelines on the amount of additional output backoff (OBO) that is required for these new rolloffs. For now, Comtech EF Data recommends that, given a $Tx\alpha$ of 0.20 or 0.15, you use an additional OBO of at least 0.5 dB; for a $Tx\alpha$ of 0.10 or 0.05, use an additional OBO of at least 1.0 dB.

- The recommended minimum carrier spacing equals $(1 + Tx\alpha) \times \text{symbol rate}$, assuming equal symbol rates for all carriers and zero frequency error between carriers.

- At lower symbol rates, particular care needs to be taken with the frequency accuracy and stability of the RF carriers. **It is your responsibility to determine if sufficient guard band is built into the frequency plan to avoid carriers moving towards each other and overlapping at the edges.**



Now that you can choose between six different values of $Tx\alpha$, it now becomes important to match the Rx Alpha ($Rx\alpha$) accordingly. Comtech EF Data has analyzed the effect of mismatching $Tx\alpha$ and $Rx\alpha$, and has concluded that there is little benefit in providing six values of $Rx\alpha$. It has been determined that just two values of $Rx\alpha$ – 0.35 and 0.12 – are required to match all six Tx cases.

In order to correctly set $Rx\alpha$ – this assumes that you have knowledge of the $Tx\alpha$ being transmitted – follow these guidelines:

- For a $Tx\alpha$ of 0.05, 0.10, 0.15, or 0.20, use $Rx\alpha = 0.12$.
- For a $Tx\alpha$ of 0.25 or 0.35, use $Rx\alpha = 0.35$.

If these rules are followed, then the amount of degradation due to mismatch will be < 0.05 dB.

If these rules are **not** followed, then the amount of degradation due to mismatch can be > 0.3 dB.

Appendix T. CDM-625A RADIUS CLIENT

T.1 Overview

Ethernet-based remote monitor and control (M&C) of the CDM-625A Advanced Satellite Modem is available through the CDM-625A HTTP (Web Server) Interface, SNMP, and through the issuance of remote commands and queries via Telnet.

For CDM-625A Advanced Satellite Modems that are equipped with the Optional IP Packet Processor, additional remote M&C access is available via the Telnet Command Line Interface (CLI).

RADIUS is the acronym for **R**emote **A**uthentication **D**ial **I**n **U**ser **S**ervice. This is a networking protocol that provides centralized access authentication, authorization, and management for CDM-625A Advanced Satellite Modems.

T.1.1 RADIUS List of Supported RFCs (Requests for Comment)

RFC No.	Description
2865	"Remote Authentication Dial In User Service (RADIUS)" Rigby, C., Willens, S., Rubens, A., Simpson, W., June 2000
1334	"PPP Authentication Protocols" Lloyd, B., Simpson, W., October 1992
1994	"PPP Challenge Handshake Authentication Protocol (CHAP)" Simpson, W., August 1996
2759	"Microsoft PPP CHAP Extensions, Version 2" Zorn, G., January 2000
2548	"Microsoft Vendor-specific RADIUS Attributes" Zorn, G., March 1999

T.2 Service Types

“Service Type” is the attribute field in the “RADIUS Access Request and RADIUS Access Response” message as defined in RFC 2865. This attribute indicates the type of service the user has requested, or the type of service to be provided.

CDM625A RADIUS client recognizes the following value fields, as assigned to the service type attribute in **RADIUS: Access-Accept** messages received from the RADIUS server, and sets access levels accordingly:

Value	Description	Access Level
6	Administrative	Admin Read write
7	NAS Prompt	Read -only
11	Callback Administrative	Read/Write access



Some RADIUS Servers might need to be reconfigured with the above service type values for corresponding user access levels.

T.3 RADIUS Client

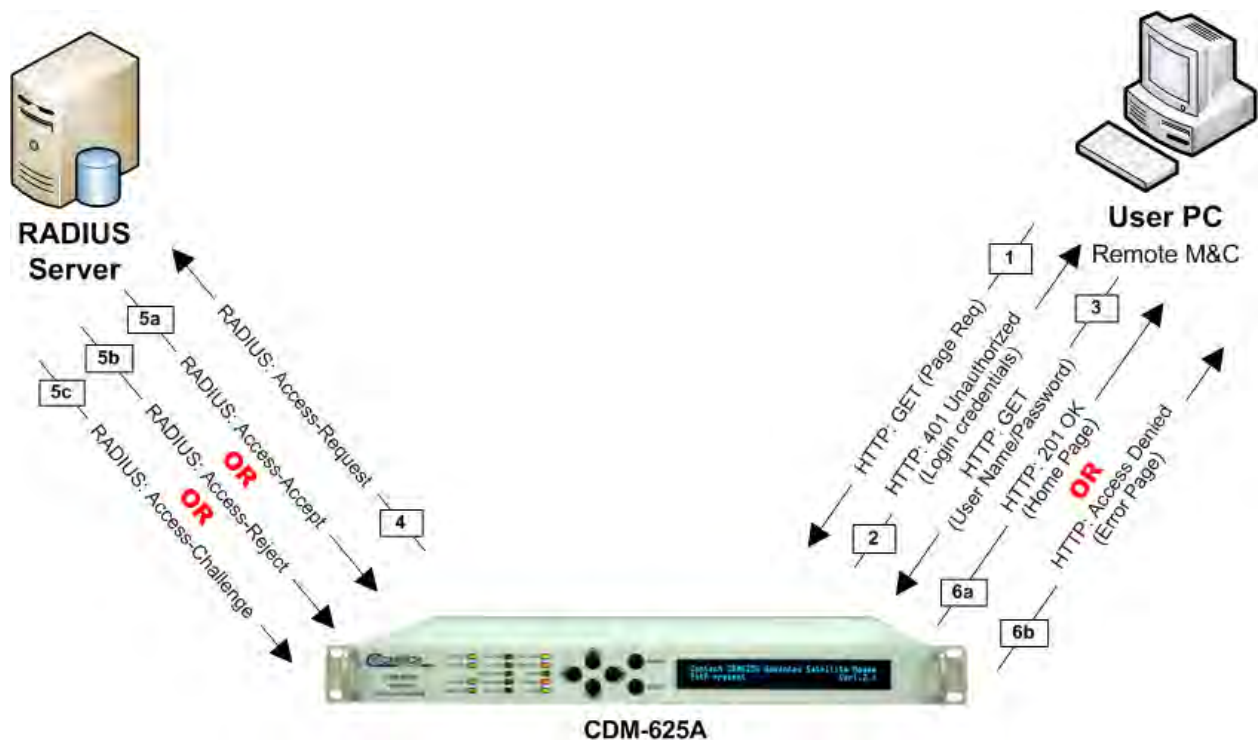



Figure T-1. RADIUS Authentication Process

Figure T-1 shows the typical RADIUS connectivity with the CDM625A Advanced Satellite Modem. Remote monitor and control of the CDM-625A Advanced Satellite Modem is accomplished with the User PC. The Modem connects to the RADIUS Server for user credential authentication.

The authentication process, as shown here, permits use of the HTTP (Web Server) Interface for remote M&C of the CDM-625A. This basic messaging sequence is the same for M&C access to the CDM-625A over the Telnet user interface:

Step	Action
1	The User PC transmits the “HTTP GET” request.
2	Upon receiving the “HTTP GET” request, the CDM-625A checks whether the user has been authenticated. If not, the CDM-625A returns “HTTP 401 Unauthorized” message to the User PC.
3	The User PC transmits the login credentials to the CDM-625A using the “HTTP GET” message.
4	The CDM-625A receives the login credentials and performs the following steps: <ul style="list-style-type: none"> A. It validates the login credentials against the locally stored Admin credentials. If the credentials match, the modem allows Read/Write access (including Admin configuration pages); it does not grant RADIUS access. B. If there is no match for the system user credentials, then the modem transmits the RADIUS: Access-Request message to the Primary RADIUS Server. C. If the Primary RADIUS Server is not available, then the modem transmits the RADIUS: Access-Request message to the Secondary RADIUS Server. D. If the Secondary RADIUS Server is not available, then the modem transmits the HTTP: Access Denied message (error page) to the User PC.
5	The RADIUS Server, upon receiving the RADIUS:Access-Req message, authenticates the user credentials and does one of the following: <ul style="list-style-type: none"> A. It transmits the RADIUS: Access-Accept message with the appropriate user access level – e.g., <i>Read-only</i> or <i>Read/Write</i>. B. It transmits the RADIUS:Access-Reject message upon credential mismatch. C. It transmits the RADIUS: Access-Challenge for further validation.
6	The CDM-625A, upon receiving one of the above responses from the RADIUS server, then does one of the following: <ul style="list-style-type: none"> A. Upon receiving the RADIUS:Access-Accept message, it transmits the “HTTP 201 OK” message to the User PC. B. Upon receiving the RADIUS: Access-Reject message, it transmits the “Access Denied” message to the User PC. C. Upon receiving the RADIUS: Access-Challenge message, it transmits the “PAP/CHAP challenge response” message to the Radius Server.
7	Upon receiving the “HTTP 201 OK” message, the user can browse the CDM-625A HTTP (Web Server) Interface pages. <div style="display: flex; align-items: center; margin-top: 10px;">  <p>Depending on the user access rights received from the RADIUS server, the CDM-625A allows the user Read-only or Read-Write access to the interface.</p> </div>

T.4 RADIUS Operation and Configuration

RADIUS is available only when you configure the CDM-625A for **IP** or **IP-ACM** operating mode. Enabling and disabling of RADIUS is possible only through:

- The CDM-625A front panel;
- The CDM-625A HTTP (Web Server) Interface **Admin | Access** page;
- Issuance of Telnet remote commands.

With RADIUS enabled, any login attempt through the HTTP, Telnet, or Telnet CLI interfaces results in the modem first contacting the RADIUS Client Server for authentication and authorization before granting remote user access. Comtech EF Data provides three levels of user access/login – Admin, Read/Write, and Read Only. Access to operations is controlled as follows:

User Access Login Level	Access Restriction(s)
Admin User (system*)	<i>Full read/write access</i> to all remote commands and queries via Telnet, Telnet CLI (when unit is equipped with the Optional IP Packet Processor), and web pages (including RADIUS configuration and control using the Admin Access web page),
Read/Write User	<ul style="list-style-type: none"> • No Access to Admin- or IP Packet Processor-related Telnet remote commands and queries, Telnet CLI, and web pages. • <i>Full read/write access</i> to all modem configuration and monitoring web pages (except Admin).
Read-Only User	<ul style="list-style-type: none"> • No Access to Admin or IP Packet Processor-related web pages, Telnet remote commands and queries, or Telnet CLI. • <i>Read Only Access</i> for all other web pages.



- **RADIUS does not control user access to the CDM-625A Front Panel, serial-based remote product management, or the SNMP user interface.**
- ***System administration under the Admin User login privilege does not require RADIUS.**
- **Admin User credentials are stored in the modem, so login as Admin User does not require the RADIUS Server connectivity.**
- **SNMP access can be disabled using System Admin access.**

Configuration of RADIUS features is possible only through the HTTP (Web Server) Interface **Admin | Access** page, or by issuance of remote commands via Telnet. No configuration of RADIUS is available from the CDM-625A front panel or through serial-based remote commands, SNMP, or the Telnet CLI.

The modem is configurable with primary and secondary RADIUS server addresses. In the event that the primary server is unavailable, the secondary server will be used to validate the user name and password.

Read/write and read-only user credentials are managed via the RADIUS Client Server – the RADIUS Client Server cannot grant Admin level access. The modem locally stores one Admin-level user name and password. If the RADIUS client is disabled or the modem cannot access the primary and the secondary server, any user trying to access the modem will be authenticated with the locally stored username and password, which provides full Admin access.



- **All user credentials are verified by the RADIUS server, when the client has connectivity to either the primary or secondary RADIUS servers.**
- **In the absence of primary or secondary RADIUS server connectivity, or when RADIUS is disabled, the locally stored Admin credentials are used for modem access.**

T.4.1 RADIUS Operation Using the CDM-625A Front Panel



Figure T-2. CDM-625A Front Panel Keypad and Vacuum Fluorescent Display



Chapter 6. FRONT PANEL OPERATION



- Access to and operation of the CDM-625A Front Panel is not controlled by RADIUS.
- Control of RADIUS operations from the front panel is limited only to enabling and disabling the feature.
- Configuration of RADIUS features is possible only using Telnet remote commands or the HTTP (Web Server) Interface Admin | Access page.

From the front panel main (**SELECT:**) menu, use the ◀▶ arrow keys to select the **Configuration** menu branch, and then press **ENTER**. From the **CONFIG:** menu branch, use the ◀▶ arrow keys to select the **IP** submenu, and then press **ENTER**. From the **IP Config:** submenu, use the arrow keys to select **Setup**, and then press **ENTER**. From the **IP Setup** submenu, use the ◀▶ arrow keys to select **Rad**.

```
SELECT: Configuration Test Monitor
Info Store/Ld Utility ODU FAST (◀ ▶)
```

```
CONFIG: All Mode Tx Rx Clocks D&I/ACM
CnC EDMAC Misc Mask Remote IP (◀ ▶)
```

```
IP Config: Addresses SNMP Setup
ANT AccessList PktP-Enable (◀ ▶)
```

```
IP Setup: Mode WAN PerPortCnfg DDMgmtPt
MAC-Lrng Rad VLAN QoS Stats FrmSize (◀ ▶)
```

```
RADIUS: Disabled (Enabled, Disabled)
(⬆)
```

Use the ▲▼ arrow keys to select RADIUS operation as **Enabled**, and then press **ENTER**.

T.4.2 RADIUS M&C Using the CDM-625A HTTP (Web Server) Interface



Chapter 7. ETHERNET-BASED REMOTE PRODUCT MANAGEMENT



The Admin pages are available only if you log in using the Administrator Name and Password.

Figure T-3. CDM-625A HTTP (Web Server) Interface Admin | Access page

- **RADIUS Client** – Use the drop-down list to set RADIUS operation as **Enabled** or **Disabled**.
- **Server Password Type** – Use the drop-down list to select the authentication protocol as PAP (Password Authentication Protocol) or CHAP (Challenge-Handshake Authentication Protocol).
- **Primary / Secondary Server IP Address** – Enter the pertinent Server IP Addresses in the form **xxx.xxx.xxx.xxx**.
- **Server Shared Secret** – **Carefully** enter the word to be used (64 characters maximum) as the "shared secret" between the RADIUS Client Server and the networked device (CDM-625A). The interface conceals this entry for security purposes.
- **Server Port** – Enter a valid port number from **1** to **65535** (the default is **1812**).

Click [**Submit Radius**] to save.

- **RADIUS Log** – This scrollable window displays the last 20 users who have logged onto the RADIUS server.

T.4.3 RADIUS M&C Using Telnet



- Chapter 7. ETHERNET-BASED REMOTE PRODUCT MANAGEMENT
- Chapter 8. SERIAL-BASED REMOTE PRODUCT MANAGEMENT



The RADIUS commands/queries are available only if you log in to the Telnet Remote Control Interface (not to be confused with the Telnet CLI – Command Line Interface) using the Administrator Name and Password.

Command/Query	Function
RAE	Enables/Disables RADIUS operation
RAA	Assigns the Primary RADIUS Client Server IP Address
RAB	Assigns the Secondary RADIUS Client Server IP Address
RAP	Assigns the RADIUS Server Port Address
RAT	Defines the RADIUS Client Server password authentication protocol
RAS	Assigns the RADIUS Client Server shared secret

Appendix U. CDM-625A FTP MODEM-TO-MODEM CONFIGURATION

U.1 Overview

Comtech EF Data provides the means, using File Transfer Protocol (FTP), to quickly “clone” the configuration of a “source” CDM-625A Advanced Satellite Modem (Modem ‘A’) to any “target” CDM-625A (Modem ‘B’) on a per-modem basis. This allows consistent network setup with minimum effort.

All Base Modem configuration parameters are stored in a simple text file that you may create using FTP. This configuration file contains a series of commands that encapsulate the source modem’s configuration – you should **not** manually edit this file except as noted. You may then transfer this parameter file by FTP to quickly configure the target modem(s) as needed.



- 1) **You may proceed with the FTP Modem-to-Modem Configuration procedure assuming that:**
 - A. **The Source (Modem ‘A’) and Target (Modem ‘B’) modems are running the latest available firmware versions (see Chapter 4. UPDATING FIRMWARE).**
 - B. **The Source (Modem ‘A’) and Target (Modem ‘B’) modems’ Ethernet ports are connected to the Ethernet ports of any user-supplied, Windows-based PC (Windows XP or Windows 7) using user-supplied hub, switch, or direct Ethernet cable connections, and the User PC is running a compatible Web browser (e.g., Internet Explorer) for use of the CDM-625 HTTP (Web Server) Interface.**
 - C. **The Source (Modem ‘A’) and Target (Modem ‘B’) modems’ “Remote Control” ports are connected to the User PC serial port(s), and the User PC is running a terminal emulator program such as PuTTY or HyperTerminal for use of the Serial Remote Product Management Interface.**
- 2) **If you are using a CDM-625A Advanced Satellite Modem with an installed and enabled optional IP Packet Processor, this procedure is available only if you log in with Administrative privileges.**

U.2 Perform the FTP Modem Configuration Procedure

U.2.1 Create the Modem Configuration File From the Source Modem

- 1) Use Command-line to send a “PING” command to confirm proper connection and communication between the User PC and the CDM-625A Source Modem:

- Open a **Command-line** window...

For Windows 95 or Windows 98, type “**command**”.

For any Windows OS versions later than Windows 98, type “**cmd**” or “**command**”.



Alternately, from [Start], select **All Programs > Accessories > Command Prompt**.

- Type “**ping xxx.xxx.xxx.xxx**” at the **Command-line** prompt (where **xxx.xxx.xxx.xxx** is the Source Modem Traffic/Management IP Address).

The response should confirm whether the Source Modem is properly connected and communicating.

- 2) Use Command-line to create, via FTP, the Modem Configuration File from the Source Modem and save it to the User PC:

- Make sure that you are in the newly created folder.
- Type “**ftp xxx.xxx.xxx.xxx**” without quotes (where **xxx.xxx.xxx.xxx** is the Source Modem Traffic/Management IP Address).



If you are using a CDM-625A Advanced Satellite Modem and you have installed and enabled the optional IP Packet Processor, use of FTP is restricted to users with Administrator privileges. You will be prompted to type in the Admin User Name and Password (the default for both is ‘comtech’) before you can continue. There are otherwise no restrictions on FTP operations for CDM-625A Base Modem users.

- Type “**get config:config_file**” without quotes at the **Command-line ftp>** prompt, and then press the **Enter** key to begin the file creation. You will observe the progress similar to this example:

```
200 Port OK
150 Opening data connection
```

```
226 Transfer complete
ftp: XXXX bytes received in X.XXSeconds XXXXXXXX.XXXbytes/sec.
ftp>
```

- Type "bye" without quotes at the **Command-line ftp>** prompt to terminate the FTP session, and then close the **Command-line** window.

U.2.2 Use the Modem Configuration File to Configure a Target Modem

- 1) **OPTIONAL** – You may optionally edit the Modem Configuration File to instruct the modem to save, upon execution of the FTP “put” command (see Step 3), the configuration parameters of this file to a specified modem configuration slot (as you would by using the CDM-625A Front Panel **SELECT: Store/Ld ▶Store** screen).

- Make sure that you are in the folder containing the Modem Configuration File (config_file) created in Sect. U.2.1.
- Use a text editor such as Windows Notepad to open the Modem Configuration File (config_file).
- Add, as the first line in the configuration file, “**SAVE MGC TO SLOT #**” without quotes (where # is modem configuration slot 0 through 9), as per this example...

```
▶SAVE MGC TO SLOT 6
MGC=0070.000...etc.
OGC=010x00xxx...etc.
DNI=100000000...etc.
etc...
```



This text string is case-sensitive. Be sure to specify an “Available” configuration slot.

- Save and close the Modem Configuration File. Continue to the next step.
- 2) Use Command-line to send a “PING” command to confirm proper connection and communication between the User PC and the CDM-625A Target Modem:
- Open a **Command-line** window...

For Windows 95 or Windows 98, type “command”.

For any Windows OS versions later than Windows 98, type “cmd” or “command”.

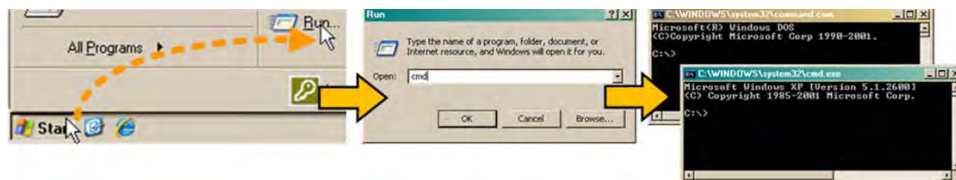

Alternately, from [Start], select **All Programs > Accessories > Command Prompt**.

- Type “**ping xxx.xxx.xxx.xxx**” without quotes (where **xxx.xxx.xxx.xxx** is the Target Modem Traffic/Management IP Address).

The response should confirm whether the Target Modem is properly connected and communicating.

3) Use Command-line to upload, via FTP, the Modem Configuration File to the Target Modem:

- Make sure that you are in the folder containing the Modem Configuration File (config_file) created in **Sect. U.2.1**.
- Type “**ftp xxx.xxx.xxx.xxx**” without quotes (where **xxx.xxx.xxx.xxx** is the Target Modem Traffic/Management IP Address).



If you are using a CDM-625A Advanced Satellite Modem and you have installed and enabled the optional IP Packet Processor, use of FTP is restricted to users with Administrator privileges. You will be prompted to type in the Admin User Name and Password (the default for both is “comtech”) before you can continue. There are otherwise no restrictions on FTP operations for CDM-625A Base Modem users.

- Type “**put config_file config:**” without quotes at the **Command-line ftp>** prompt, and then press the **Enter** key to begin the file upload. You will observe the progress similar to this example:

```
200 Port OK
150 Opening data connection
226 Upgrade in progress. Do not reboot until upgrade completes.
ftp: XXXX bytes sent in X.XXSeconds XXXXXXXX.XXXbytes/sec.
ftp>
```

- Type “**bye**” to terminate the FTP session, and then close the **Command-line** window.

4) Re-define the Target Modem Traffic/Management IP Address.

When you upload the Modem Configuration File into the Target Modem, all configuration parameters are “cloned” on the Target Modem – *including the Source Modem defined Traffic/Management IP Address*.

To prevent any network operating conflicts, use one of the following methods to re-assign the Traffic Modem Traffic/Management IP Address.



You will not be able to use the CDM-625A HTTP (Web Server) Interface until you re-define the Target Modem Traffic/Management IP Address.

- **Use the CDM-625 Front Panel keypad.** Use the ◀▶ arrow keys to access the nested ‘Ethernet IP Address/Range’ screen (**SELECT: Configuration ▶IP ▶Addresses ▶Addr/Range**):

```
SELECT: Configuration Test Monitor
Info Store/Ld Utility ODU FAST (◀ ▶)
```

```
CONFIG: All Mode Tx Rx Clocks D&I/ACM
CnC EDMAC Misc Mask Remote IP (◀ ▶)
```

```
IP Config: Addresses SNMP Setup
ANT AccessList PktP-Enable (◀ ▶)
```

```
Ethernet IP Address/Range:
192.168.001.091/24 (◀ ▶ ⬇)
```

To configure the Target Modem Traffic/Management IP Address, use the ◀▶ arrow keys to select a digit to edit, and then the ▲▼ arrow keys to change that digit. Press ENTER when done.



The IP Address that appears here is provided as an example only. Make sure that you re-use the Traffic/Management IP Address that was assigned to the Target Modem prior to reconfiguration.

- **Use Serial Remote Control.** Type the “<0/IPA=XXX.XXX.XXX.XX{CR}” remote command without quotes at the Serial Interface command prompt (where xxx.xxx.xxx.xxx is the Target Modem Traffic/Management IP Address) to configure. You may issue the remote query (<0/IPA? {CR}{LF}) to report back the result:

>0/IPA=192.168.001.091.24 (example)

The CDM-625A Target Modem is now configured to operate identically to the CDM-625A Source Modem. The FTP Modem-to-Modem Configuration procedure is now complete.



2114 WEST 7TH STREET TEMPE ARIZONA 85281 USA
480 • 333 • 2200 PHONE
480 • 333 • 2161 FAX