



DMD20/DMD20LBST

Universal Satellite Modem Installation and Operation Manual

IMPORTANT NOTE: The information contained in this document supersedes all previously published information regarding this product. This manual is subject to change without prior notice.

Errata A for MN-DMD20-20LBST Rev 14

Comtech EF Data Documentation Update

DMD20/DMD20LBST

Universal Satellite Modem
Installation and Operation Manual

Part Number MN-DMD20-20LBST

Revision 14

Subject: Chapter 7, Technical Specifications

Errata Part Number: ER-DMD20LBS-EA14 (*Errata documents are not subject to revision.*)

PLM CO Number: C-0026230

Comments: See attached page(s). The new information will be included in the next released revision of the manual.

Blank Page

Chapter 7. TECHNICAL SPECIFICATIONS

7.1 Data Rates

Refer to Section 7.18.

7.2 Modulator

Modulation	BPSK, QPSK, and OQPSK (8PSK, 16QAM Optional)
IF Tuning Range	50 to 90, 100 to 180 MHz in 1 Hz Steps
L-Band Tuning Range	950 to 2050 MHz in 1 Hz Steps
Impedance	IF, 75-Ohm (50-Ohm Optional) L-Band, 50-Ohm
Connector	BNC, 75-Ohm SMA, 50-Ohm, L-Band or N-type, 50-Ohm LBST
Return Loss	IF, 20 dB Minimum L-Band, 14 dB Minimum
Output Power	0 to -25 dB
Output Stability	IF: ± 0.5 dB Over Time and Temperature L-Band: ± 1.0 dB Over Time and Temperature
Output Spectrum	Meets IESS 308/309/310 Power Spectral Mask
Spurious	-50 dBc In-Band (50 to 90 MHz, 100 to 180 MHz, 950 to 2050 MHz) -45 dBc Out-of-Band
On/Off Power Ratio	>60 dB
Scrambler	CCITT V.35 or IBS (Others Optional)
FEC	Viterbi, {1/2, 3/4, 7/8, None} K = 7 Sequential {1/2, 3/4, 7/8} CSC {3/4} Trellis (8PSK) {2/3} DVB VIT {1/2, 2/3, 3/4, 5/6, 7/8} DVB Trellis {2/3, 3/4, 5/6, 7/8, 8/9}
	Turbo Product Code (Optional) – (SuperCard ONLY)
	Turbo (BPSK) {21/44, 5/16}
	Turbo (OQPSK/QPSK) {1/2, 3/4, 7/8}
	Turbo (8PSK) {3/4, 7/8}
	Turbo (16QAM) {3/4, 7/8}
	Legacy Turbo Rates {0.495, 0.793} < 5Mbps

	LDPC/TPC (Optional)	
	LDPC (BPSK)	{1/2}
	LDPC (OQPSK/QPSK)	{1/2, 2/3, 3/4}
	LDPC (8PSK/8QAM)	{2/3, 3/4}
	LDPC (16QAM)	{3/4}
	Turbo (BPSK)	{21/44}
	Turbo (QPSK/OQPSK)	{1/2, 2/3, 3/4, 7/8}
	Turbo (8QAM/8PSK)	{2/3, 3/4, 7/8}
	Turbo (16QAM)	{3/4, 7/8}
Outer Encoder Options	Reed-Solomon INTELSAT (DVB Optional, Custom Rates Optional)	
Data Clock Source	Internal, External, Rx Recovered	
Internal Stability	1 x 10 ⁻⁶ Typical (Optional to 5 x 10 ⁻⁸) DMD20 5 x 10 ⁻⁸ Typical DMD20 LBST	

7.3 Demodulator

Demodulation	BPSK, QPSK, and OQPSK (8PSK, 16QAM Optional)	
IF Tuning Range	50 to 90, 100 to 180 MHz in 1 Hz Steps	
L-Band Tuning Range	950 to 2050 MHz in 1 Hz Steps	
Impedance	IF, 75-Ohm (50-Ohm optional)	
	L-Band, 50-Ohm	
Connector	BNC - 75 Ohm SMA - 50 Ohm N-type 50-Ohm LBST	
Return Loss	IF, 20 dB Minimum SMA, 50-Ohm, L-Band L-Band, 14 dB Minimum	
Spectrum	INTELSAT IESS 308/309/310 Compliant	
Input Level	10 x log (Symbol Rate) - 100, ±12 dB	
Adjacent Channel Rejection Ratio	>+10 dBc	
Total Input Power	-10 dBm or +40 dBc (the Lesser) @ 256 Kbps	
FEC	Viterbi	{1/2, 3/4, 7/8, None} K = 7
	Sequential	{1/2, 3/4, 7/8}
	CSC	{3/4}
	Trellis (8PSK)	{2/3}
	DVB VIT	{1/2, 2/3, 3/4, 5/6, 7/8}
	DVB Trellis	{2/3, 3/4, 5/6, 7/8, 8/9}
	Turbo Product Code (Optional) – (SuperCard ONLY)	
	Turbo (BPSK)	{21/44, 5/16}
	Turbo (OQPSK/QPSK)	{1/2, 3/4, 7/8}
	Turbo (8PSK)	{3/4, 7/8}
	Turbo (16QAM)	{3/4, 7/8}
	Legacy Turbo Rates	{0.495, 0.793} < 5Mbps
	LDPC/TPC (Optional)	
	LDPC (BPSK)	{1/2}
	LDPC (OQPSK/QPSK)	{1/2, 2/3, 3/4}
	LDPC (8PSK/8QAM)	{2/3, 3/4}
	LDPC (16QAM)	{3/4}
	Turbo (BPSK)	{21/44}
	Turbo (QPSK/OQPSK)	{1/2, 2/3, 3/4, 7/8}
	Turbo (8QAM/8PSK)	{2/3, 3/4, 7/8}
	Turbo (16QAM)	{3/4, 7/8}

Decoder Options	Reed-Solomon INTELSAT (DVB Optional, Custom Rates Optional)
Descrambler	CCITT V.35 or IBS (Others Optional)
Acquisition Range	Programmable ± 1 kHz to ± 255 kHz
Sweep Delay Value	100 msec to 6000 sec. in 100 msec Steps

7.4 Plesiochronous Buffer

Size	0 msec to 64 msec
Centering	Automatic on Underflow/Overflow
Centering Modes	IBS: Integral Number of Frames IDR: Integral Number of Multi Frames
Clock	Transmit, External, Rx Recovered or SCT (Internal)

7.5 Monitor and Control

Remote RS-485/Terminal RS-232/Ethernet 10 Base-T/Web Browser,
DMD15 Protocol Compatible

7.6 DMD20/DMD20 LBST Drop and Insert (Optional)

Terrestrial Data	1.544 Mbps or 2.048 Mbps, G.732/733
Line Coding	AMI or B8ZS for T1 and HDB3 for E1
Framing	D4, ESF and PCM-30 (PCM-30C) or PCM-31 (PCM-31C) for E1
Time Slot Selection	n x 64 Contiguous or Arbitrary Blocks for Drop or Insert.
Time Slots	TS1, 2, 3, 4, 5, 6, 8, 10, 12, 15, 16, 20, 24, 30, 31
Data Rates	64, 128, 192, 256, 320, 384, 512, 640, 768, 960, 1024, 1280, 1536, 1920 Kbps
Efficient D&I Time Slots	Closed Network, Satellite Overhead 0.4% 1-31 Any combination

7.7 Terrestrial Interfaces

A variety of standard interfaces are available for the DMD20/DMD20 LBST modem in stand-alone applications.

7.8 IDR/ESC Interface (Optional)

G.703 T1 (DSX1)	1.544 Mbps, 100-Ohm Balanced, AMI and B8ZS
G.703 E1	2.048 Mbps, 75-Ohm Unbalanced and 120-Ohm Balanced, HDB3
G.703 T2 (DSX2)	6.312 Mbps, 75-Ohm Unbalanced and 110-Ohm Balanced, B8ZS and B6ZS
G.703 E2	8.448 Mbps, 75-Ohm BNC, Unbalanced, HDB3

7.9 IBS/Synchronous Interface (Standard)

RS-422/-530	All Rates, Differential, Clock/Data, DCE
ITU V.35	All Rates, Differential, Clock/Data, DCE
RS-232	(DCE up to 200 Kbps)

7.10 High-Speed Serial Interface (HSSI)

HSSI: HSSI, Serial, 50-Pin SCSI-2 Type Connector (Female)

7.11 ASI

ASI/RS-422 Parallel: ASI, Serial, 75-Ohm BNC (Female)
DVB/M2P, Parallel, RS-422, DB-25 (Female)

ASI/LVDS Parallel: ASI, Serial, 75-Ohm BNC (Female)
DVB/M2P, Parallel, LVDS, DB-25 (Female)

7.12 DVB/M2P

DVB/M2P: DB-25 Female Connector. It complies with RS-422 Electrical Specifications.

7.13 Ethernet Data Interface (Optional)

Ethernet Data Interface Four RJ-45, Auto-Crossover, Auto-Sensing, 10/100 Ethernet Data Ports. Complies with IEEE 802.3 and IEEE 802.3u.

7.14 Gigi Ethernet Data Interface (Optional)

Ethernet Data Interface Three RJ-45, Auto-Crossover, Auto-Sensing, 10/100/1000 Ethernet Data Ports. Complies with IEEE 802.3 and IEEE 802.3u.

7.15 HSSI / G703

HSSI	High-Speed Serial Interface, 50-pin SCSI-2 Type Connector (Female)
G.703 T1 (DSX1)	1.544 Mbps, 100-Ohm Balanced, AMI and B8ZS
G.703 E1	2.048 Mbps, 75-Ohm Unbalanced and 120-Ohm Balanced, HDB3
G.703 T2 (DSX2)	6.312 Mbps, 75-Ohm Unbalanced and 110-Ohm Balanced, B8ZS and B6ZS
G.703 E2	8.448 Mbps, 75-Ohm BNC, Unbalanced, HDB3

Note: Does not support backward alarms

7.16 HSSI /ETHERNET

HSSI	HSSI, High-Speed Serial Interface, 50-pin SCSI-2 Type Connector (Female)
Ethernet Data Interface	Four RJ-45, Auto-Crossover, Auto-Sensing, 10/100 Ethernet Data Ports. Complies with IEEE 802.3 and IEEE 802.3u.

7.17 Environmental

Prime Power	100 to 240 VAC, 50 to 60 Hz, 40 Watts Maximum 48 VDC (Optional)
Operating Temperature	0 to 50°C, 95% Humidity, Non-Condensing
Storage Temperature	-20 to 70°C, 99% humidity, Non-Condensing

7.18 Physical

	DMD20	DMD20 LBST
Size	19" W x 16" D x 1.75" H (48.26 x 40.64 x 4.45 cm)	19" W x 19.25" D x 1.75" H (48.26 x 48.89 x 4.45 cm)
Weight	6.5 Pounds (3.0 Kg)	8.5 pounds (3.83 kg)

7.19 DMD20/DMD20 LBST Data Rate Limits

7.19.1 Non-DVB

Modulation	Code Rate	Min Data Rate	Max Data Rate	Option Card
BPSK	NONE	4800	10000000	
BPSK	VIT 1/2	2400	5000000	
BPSK	VIT 3/4	3600	7500000	
BPSK	VIT 7/8	4200	8750000	
BPSK	SEQ 1/2	2400	2048000	
BPSK	SEQ 3/4	3600	2048000	
BPSK	CSEQ 3/4	3600	2048000	
BPSK	SEQ 7/8	4200	2048000	
BPSK	TPC 21/44	2400	4772727	Supercard
BPSK	TPC .495	2376	4900000	Supercard
BPSK	TPC .793	3806	6300000	Supercard
BPSK	TPC 3/4	4100	6990000	Supercard
BPSK	TPC 7/8	4200	8200000	Supercard
BPSK	TPC 21/44	18000	477000	LDPC/TPC Card
BPSK	LDPC 1/2	18000	5000000	LDPC/TPC Card
QPSK	NONE	9600	20000000	
QPSK	VIT 1/2	4800	10000000	
QPSK	VIT 3/4	7200	15000000	
QPSK	VIT 7/8	8400	17500000	
QPSK	SEQ 1/2	4800	2048000	
QPSK	SEQ 3/4	7200	2048000	
QPSK	CSEQ 3/4	7200	2048000	

Modulation	Code Rate	Min Data Rate	Max Data Rate	Option Card
QPSK	SEQ 7/8	8400	2048000	
QPSK	TPC 1/2	4582	9545454	Supercard
QPSK	TPC 3/4	7200	15000000	Supercard
QPSK	TPC 7/8	8400	17500000	Supercard
QPSK	TPC .495	4752	6312000	Supercard
QPSK	TPC .793	7612	6312000	Supercard
QPSK	LDPC 1/2	18000	10000000	LDPC/TPC Card
QPSK	LDPC 2/3	24000	13333333	LDPC/TPC Card
QPSK	LDPC 3/4	27000	15000000	LDPC/TPC Card
QPSK	TPC 1/2	18000	9545400	LDPC/TPC Card
QPSK	TPC 3/4	27000	15000000	LDPC/TPC Card
QPSK	TPC 7/8	31500	17500000	LDPC/TPC Card
OQPSK	NONE	9600	20000000	
OQPSK	VIT 1/2	4800	10000000	
OQPSK	VIT 3/4	7200	15000000	
OQPSK	VIT 7/8	8400	17500000	
OQPSK	SEQ 1/2	4800	2048000	
OQPSK	SEQ 3/4	7200	2048000	
OQPSK	SEQ 7/8	8400	2048000	
OQPSK	TPC 1/2	4582	9545454	Supercard
OQPSK	TPC 3/4	7200	15000000	Supercard
OQPSK	TPC 7/8	8400	17500000	Supercard
OQPSK	TPC .495	4752	6312000	Supercard
OQPSK	TPC .793	7612	6312000	Supercard
OQPSK	LDPC 1/2	18000	10000000	LDPC/TPC Card
OQPSK	LDPC 2/3	24000	13333333	LDPC/TPC Card
OQPSK	LDPC 3/4	27000	15000000	LDPC/TPC Card
OQPSK	TPC 1/2	18000	9545400	LDPC/TPC Card
OQPSK	TPC 3/4	27000	15000000	LDPC/TPC Card
OQPSK	TPC 7/8	31500	17500000	LDPC/TPC Card
8PSK	TRE 2/3	9600	20000000	
8PSK	TPC 3/4	10800	20000000	Supercard
8PSK	TPC 7/8	12600	20000000	Supercard
8PSK	TPC .495	9504	6312000	Supercard
8PSK	TPC .793	15225	6312000	Supercard
8PSK/8QAM	LDPC 2/3	36000	20000000	LDPC/TPC Card

Modulation	Code Rate	Min Data Rate	Max Data Rate	Option Card
8PSK/8QAM	LDPC 3/4	40500	20000000	LDPC/TPC Card
8PSK	TPC 3/4	40000	20000000	LDPC/TPC Card
8PSK	TPC 7/8	48000	20000000	LDPC/TPC Card
16QAM	VIT 3/4	14400	20000000	
16QAM	VIT 7/8	16840	20000000	
16QAM	TPC 3/4	1440	20000000	Supercard
16QAM	TPC 7/8	16800	20000000	Supercard
16QAM	TPC .495	9504	6312000	Supercard
16QAM	TPC .793	15225	6312000	Supercard
16QAM	TPC 3/4	54000	20000000	LDPC/TPC Card
16QAM	TPC 7/8	63000	20000000	LDPC/TPC Card
16QAM	LDPC 3/4	54000	20000000	LDPC/TPC Card

7.19.2 DVB

187 Mode			
Modulation	Code Rate	Min Data Rate	Max Data Rate
BPSK	VIT 1/2	2400	4583333
BPSK	VIT 2/3	2934	6111111
BPSK	VIT 3/4	3300	6875000
BPSK	VIT 5/6	3667	7638888
BPSK	VIT 7/8	3850	8020833
QPSK	VIT 1/2	4400	9166666
QPSK	VIT 2/3	5867	12222222
QPSK	VIT 3/4	6600	13750000
QPSK	VIT 5/6	7334	15277777
QPSK	VIT 7/8	7700	16041666
8PSK	TRE 2/3	8800	18333333
8PSK	TRE 5/6	11000	20000000
8PSK	TRE 8/9	11734	20000000
16QAM	TRE 3/4	13200	20000000
16QAM	TRE 7/8	15400	20000000

188 Mode			
Modulation	Code Rate	Min Data Rate	Max Data Rate
BPSK	VIT 1/2	2400	4607843
BPSK	VIT 2/3	2950	6143790
BPSK	VIT 3/4	3318	6911764
BPSK	VIT 5/6	3687	7679738
BPSK	VIT 7/8	3871	8063725
QPSK	VIT 1/2	4424	9215686
QPSK	VIT 2/3	5899	12287581
QPSK	VIT 3/4	6636	13823529
QPSK	VIT 5/6	7373	15359477
QPSK	VIT 7/8	7742	16127450
8PSK	TRE 2/3	8848	18431372
8PSK	TRE 5/6	11059	20000000
8PSK	TRE 8/9	11797	20000000
16QAM	TRE 3/4	13271	20000000
16QAM	TRE 7/8	15483	20000000

204 Mode			
Modulation	Code Rate	Min Data Rate	Max Data Rate
BPSK	VIT 1/2	2400	5000000
BPSK	VIT 2/3	3200	6666666
BPSK	VIT 3/4	3600	7500000
BPSK	VIT 5/6	4000	8333333
BPSK	VIT 7/8	4200	8750000
QPSK	VIT 1/2	4800	10000000
QPSK	VIT 2/3	6400	13333333
QPSK	VIT 3/4	7200	15000000
QPSK	VIT 5/6	8000	16666666
QPSK	VIT 7/8	8400	17500000
8PSK	TRE 2/3	9600	20000000
8PSK	TRE 5/6	12000	20000000
8PSK	TRE 8/9	12800	20000000
16QAM	TRE 3/4	14400	20000000
16QAM	TRE 7/8	16800	20000000

7.20 BER Specifications

7.20.1 BER Performance (Viterbi)

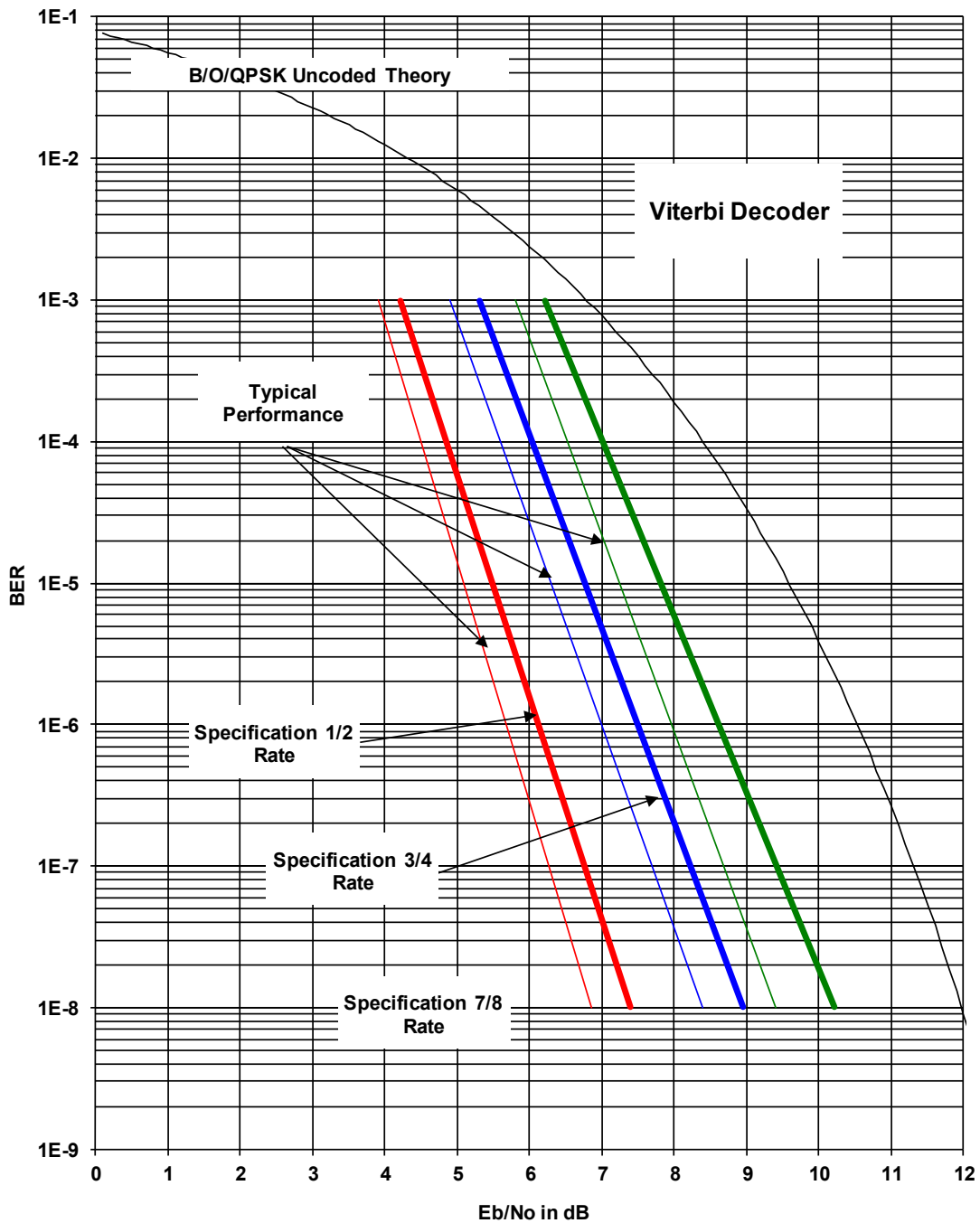

Figure 7-1 DMD20/20LBST B/O/QPSK BER Performance (Viterbi)

Note: Eb/No values include the effect of using Differential Decoding and V.35 descrambling.

7.20.2 BER Performance (Sequential)

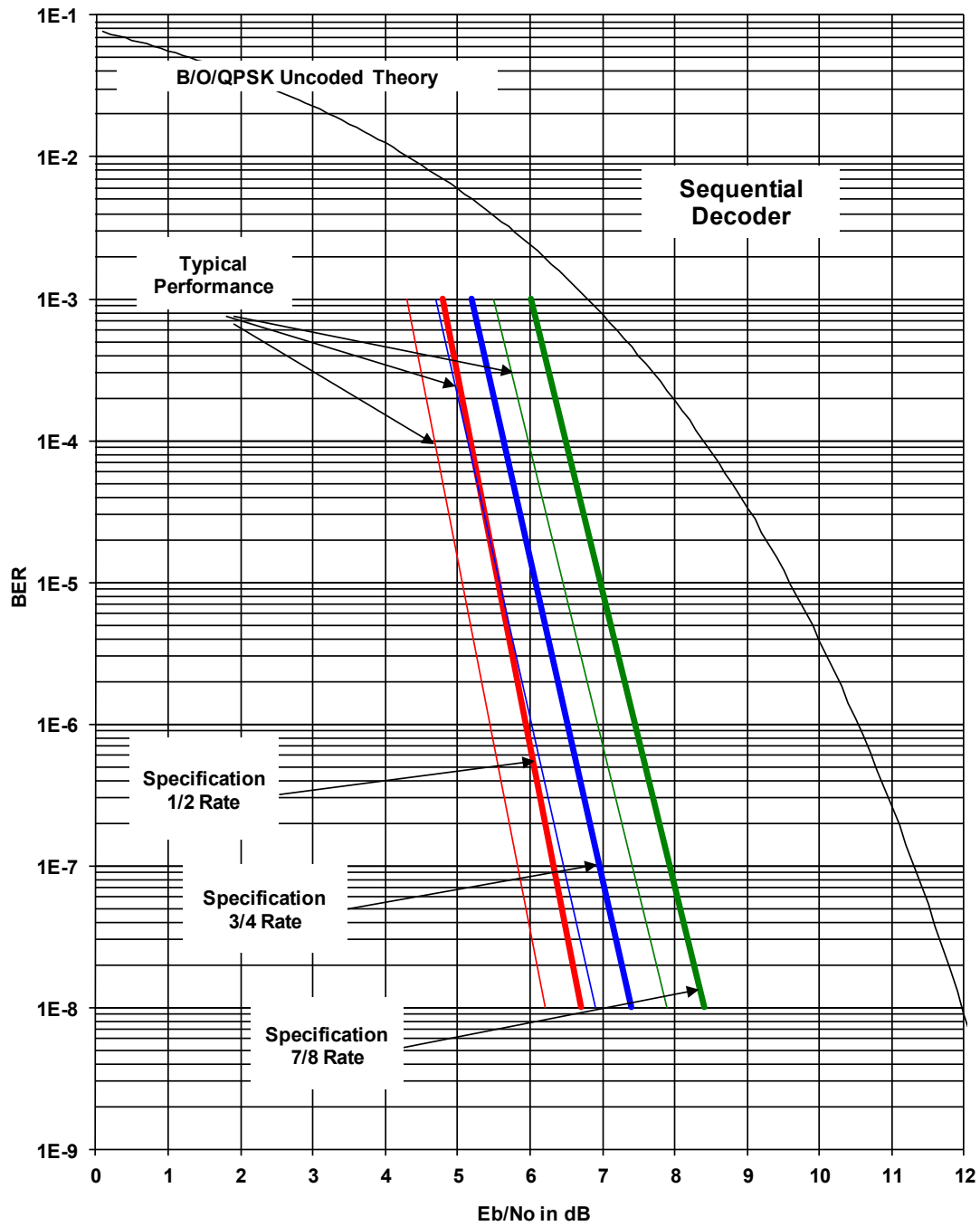

Figure 7-2 DMD20/20LBST B/O/QPSK BER Performance (Sequential)

Note: E_b/N_0 values include the effect of using Differential Decoding and V.35 descrambling.

7.20.3 BER Performance (Viterbi with Reed-Solomon)

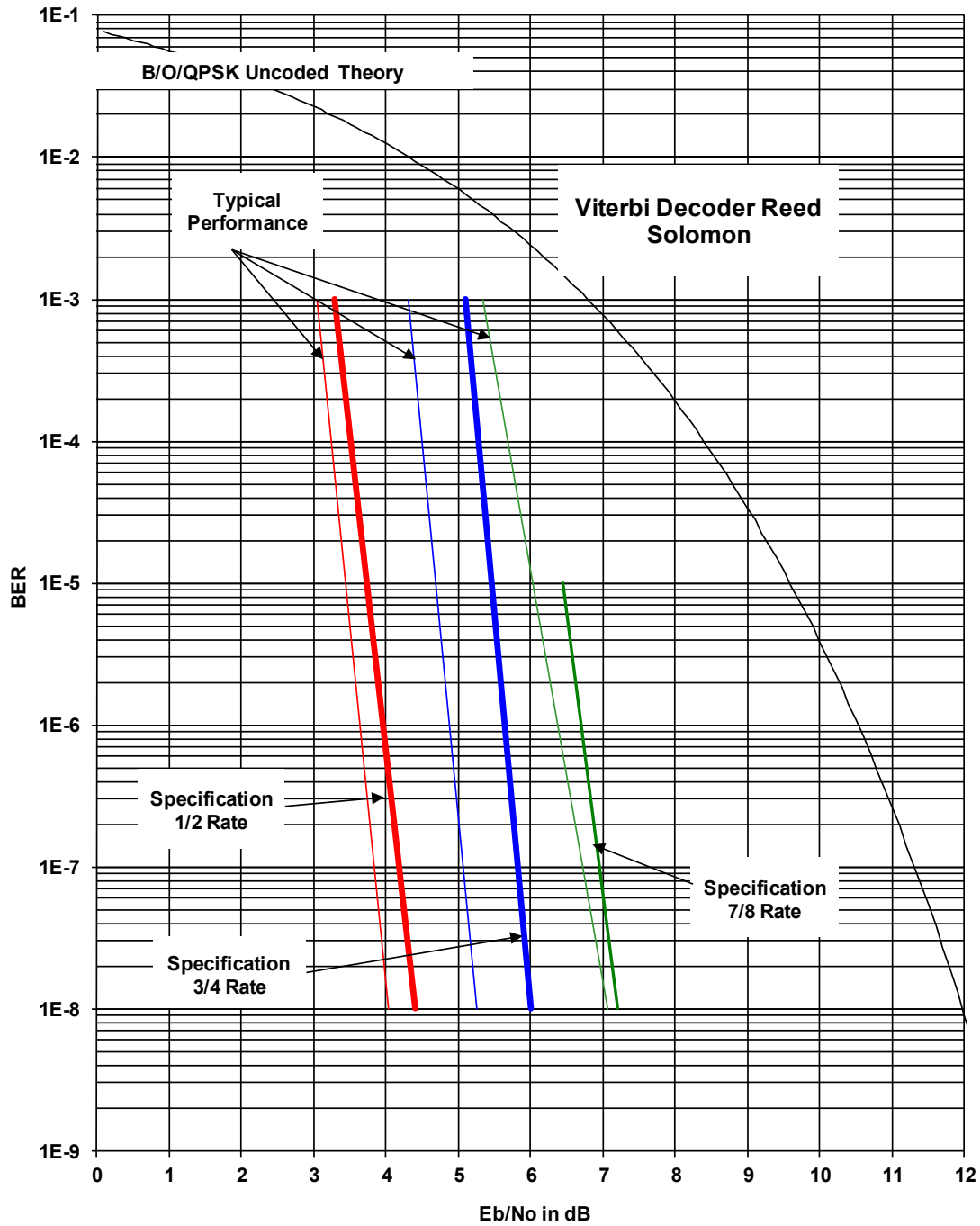

Figure 7-3 DMD20/20LBST B/O/QPSK BER Performance (Viterbi w/R-S)

Note: Eb/No values include the effect of using Differential Decoding.

7.20.4 BER Performance (Turbo)

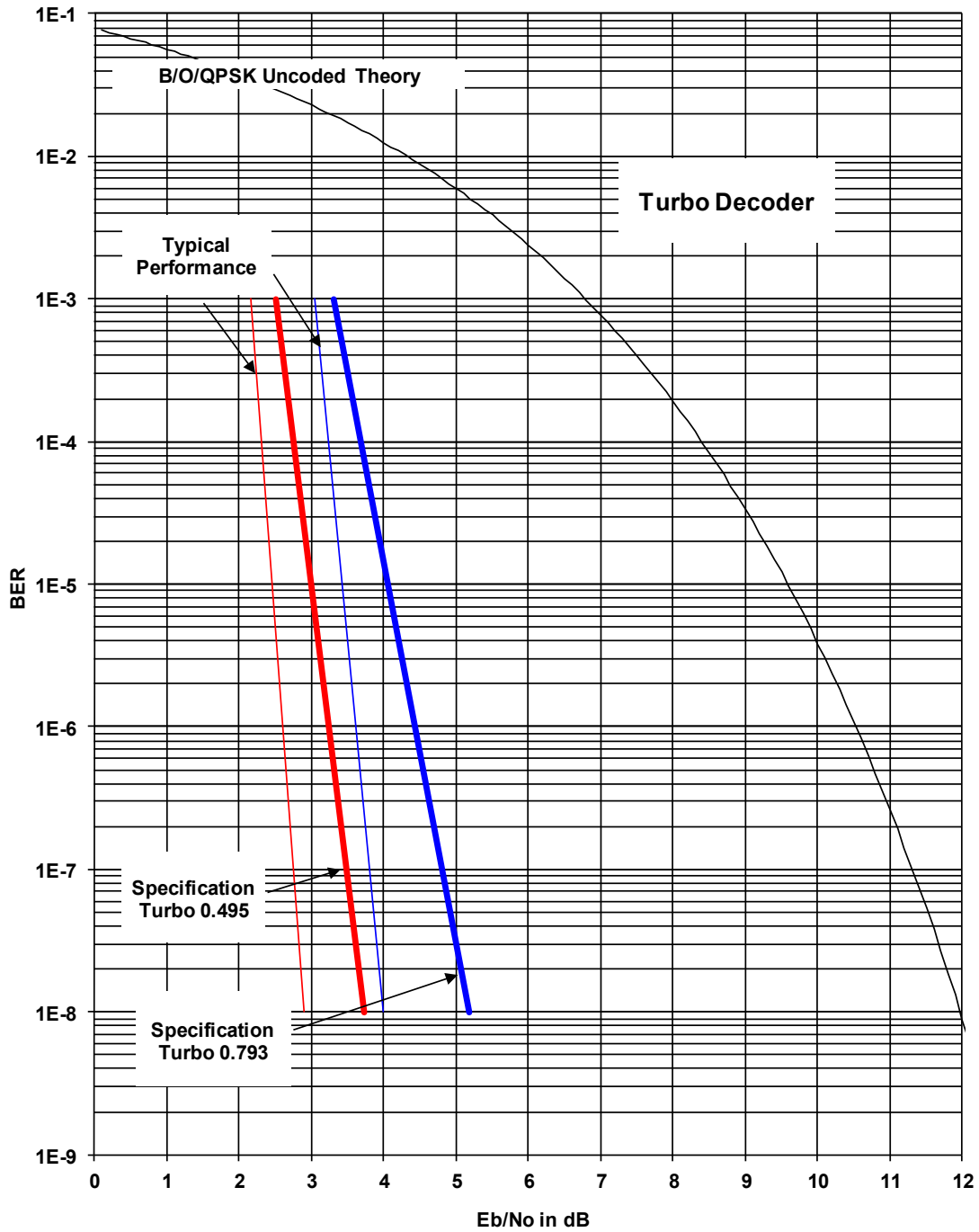

Figure 7-4 DMD20/20LBST B/O/QPSK BER Performance (Turbo)

7.20.5 BER Performance (8PSK Trellis)

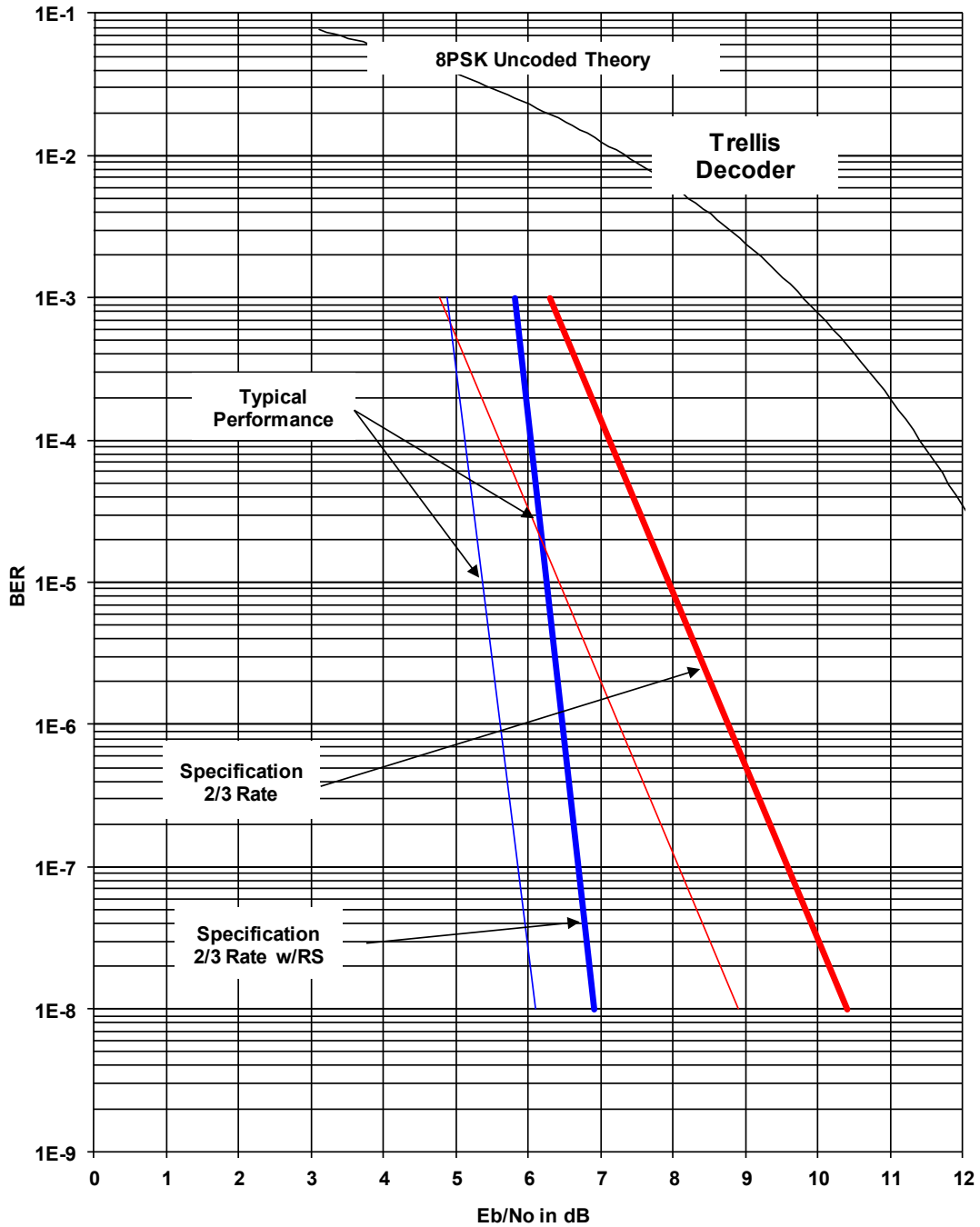

Figure 7-5 DMD20/20LBST 8PSK BER Performance (Trellis)

Note: Eb/No values include the effect of using interleaving and maximum iterations.

7.20.6 BER Performance (8PSK Turbo)

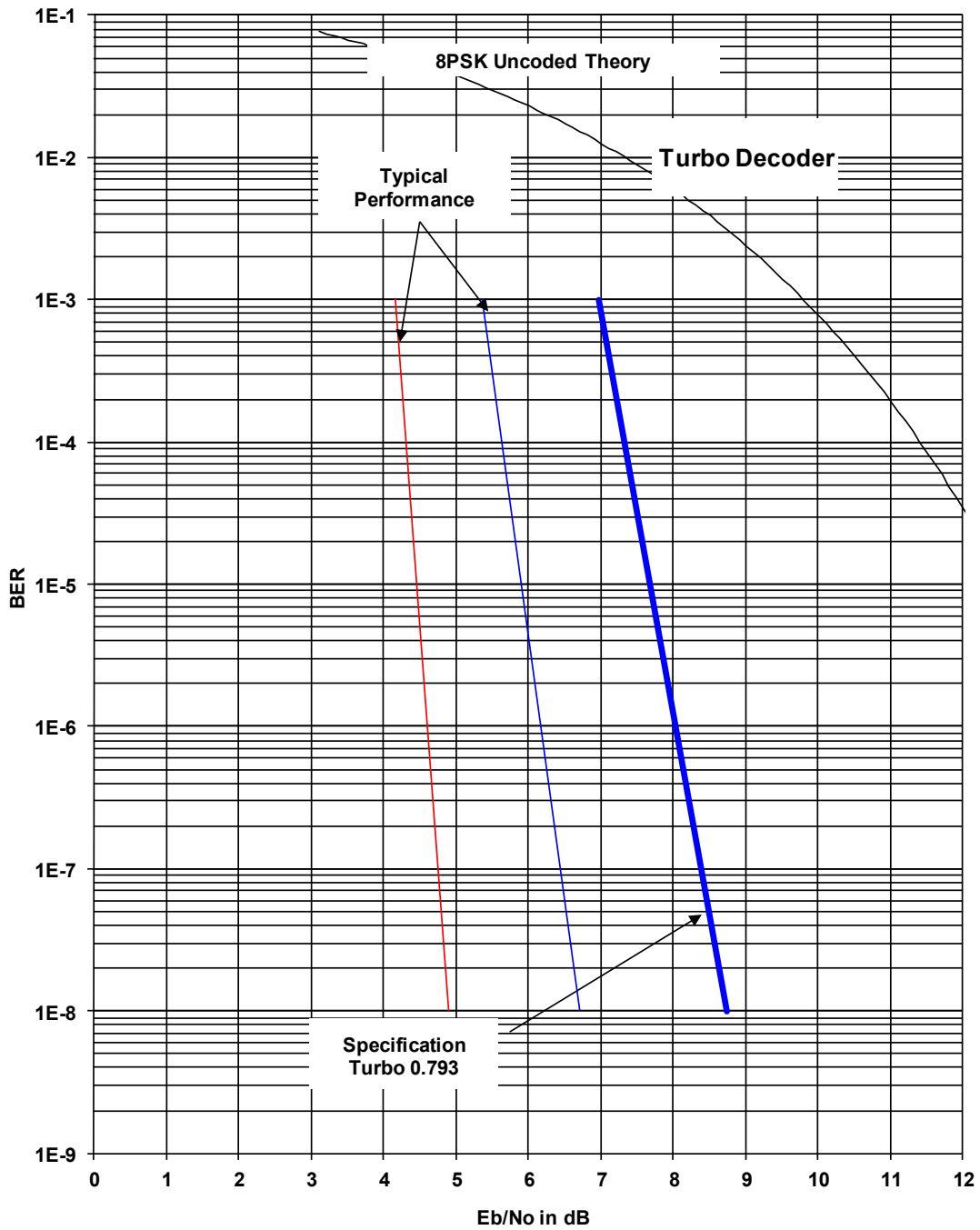

Figure 7-6 DMD20/20LBST 8PSK BER Performance (Turbo)

Note: Eb/No values include the effect of using interleaving and maximum iterations

7.20.7 BER Performance (16QAM Viterbi)

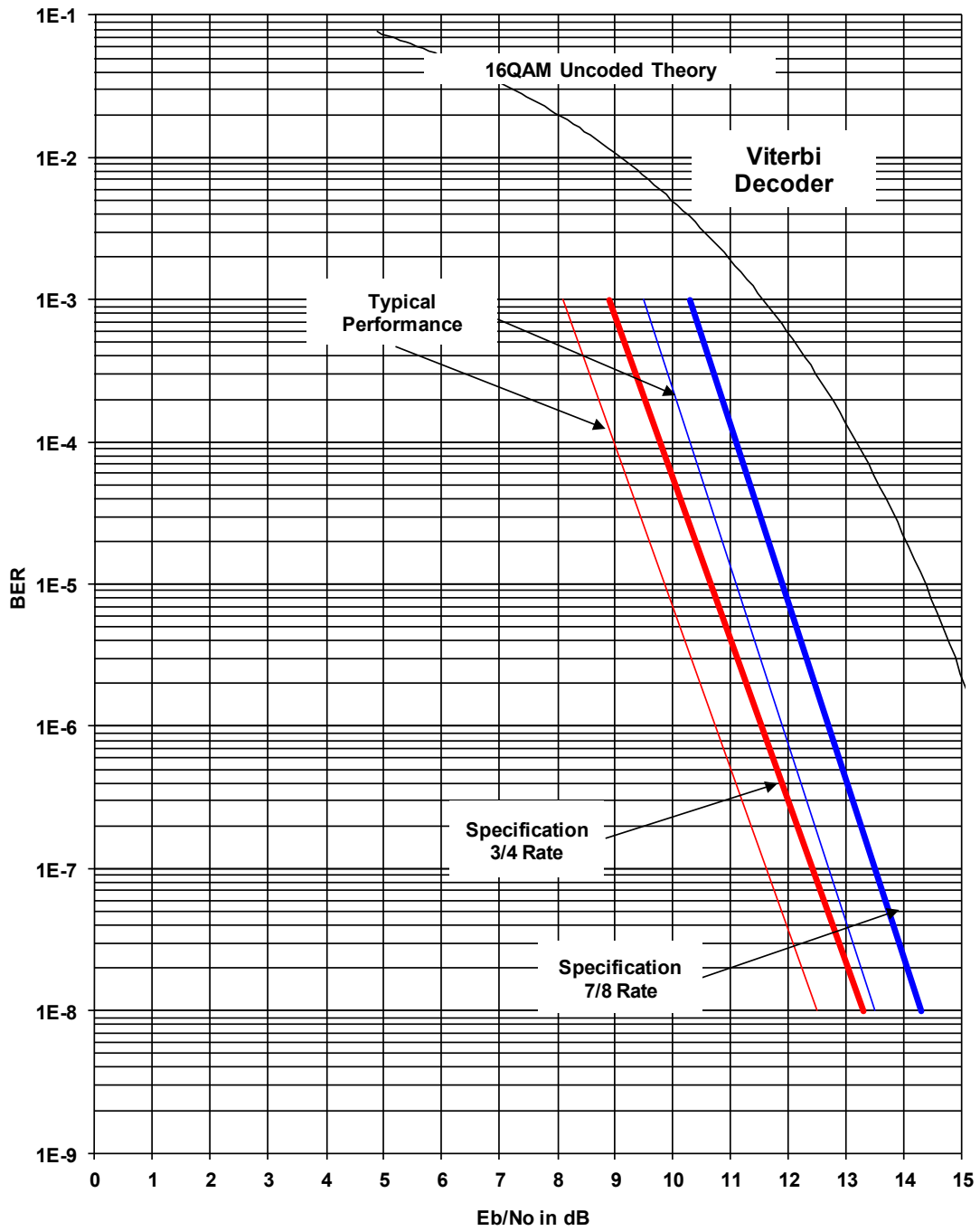

Figure 7-7 DMD20/20LBST 16QAM BER Performance (Viterbi)

Note: Eb/No values include the effect of using Differential Decoding and V.35 Descrambling.

7.20.8 BER Performance (16QAM Viterbi with Reed-Solomon)

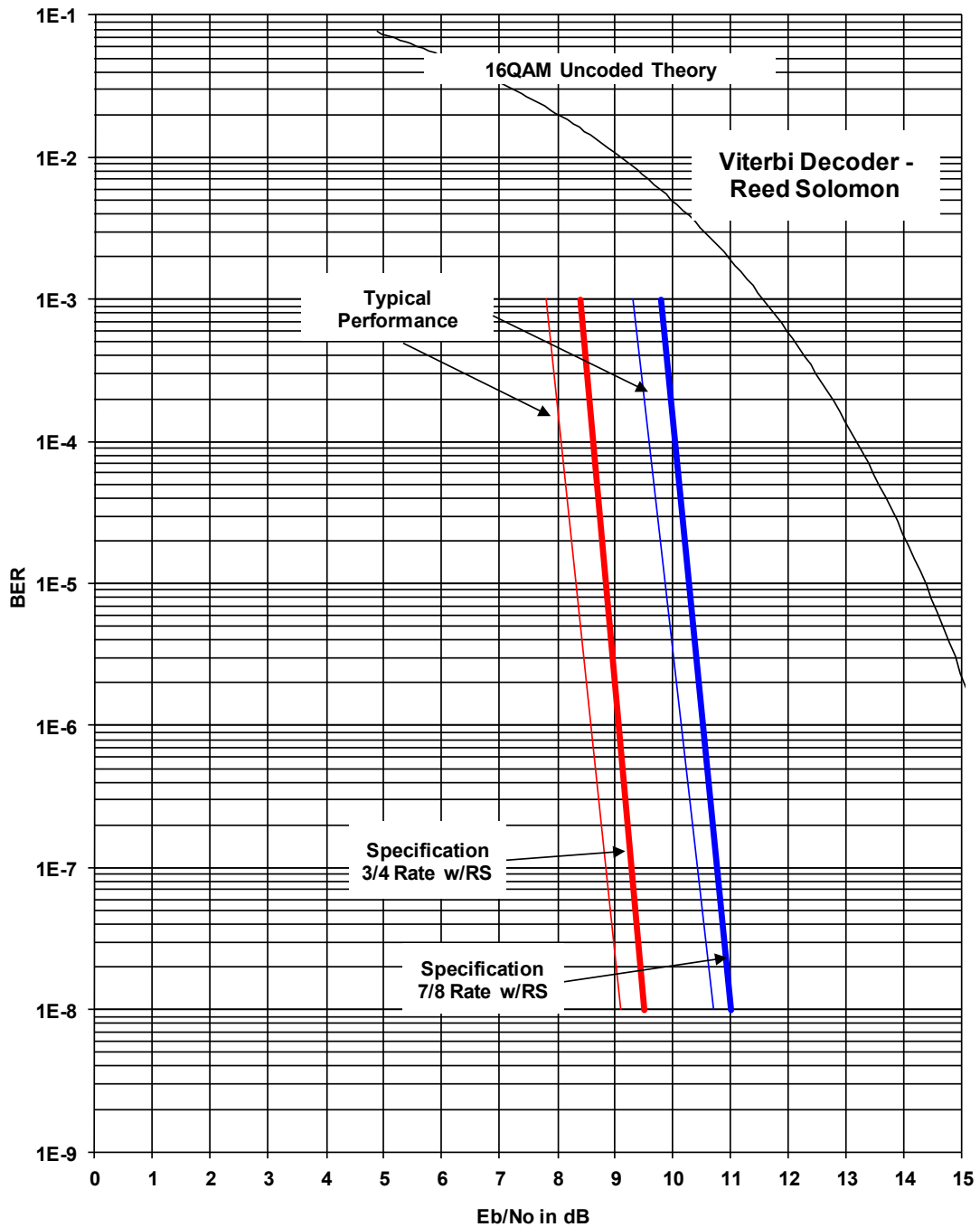

Figure 7-8 DMD20/20LBST 16QAM BER Performance (Viterbi w/R-S)

Note: Eb/No values include the effect of using Differential Decoding.

7.20.9 BER Performance (16QAM Turbo)

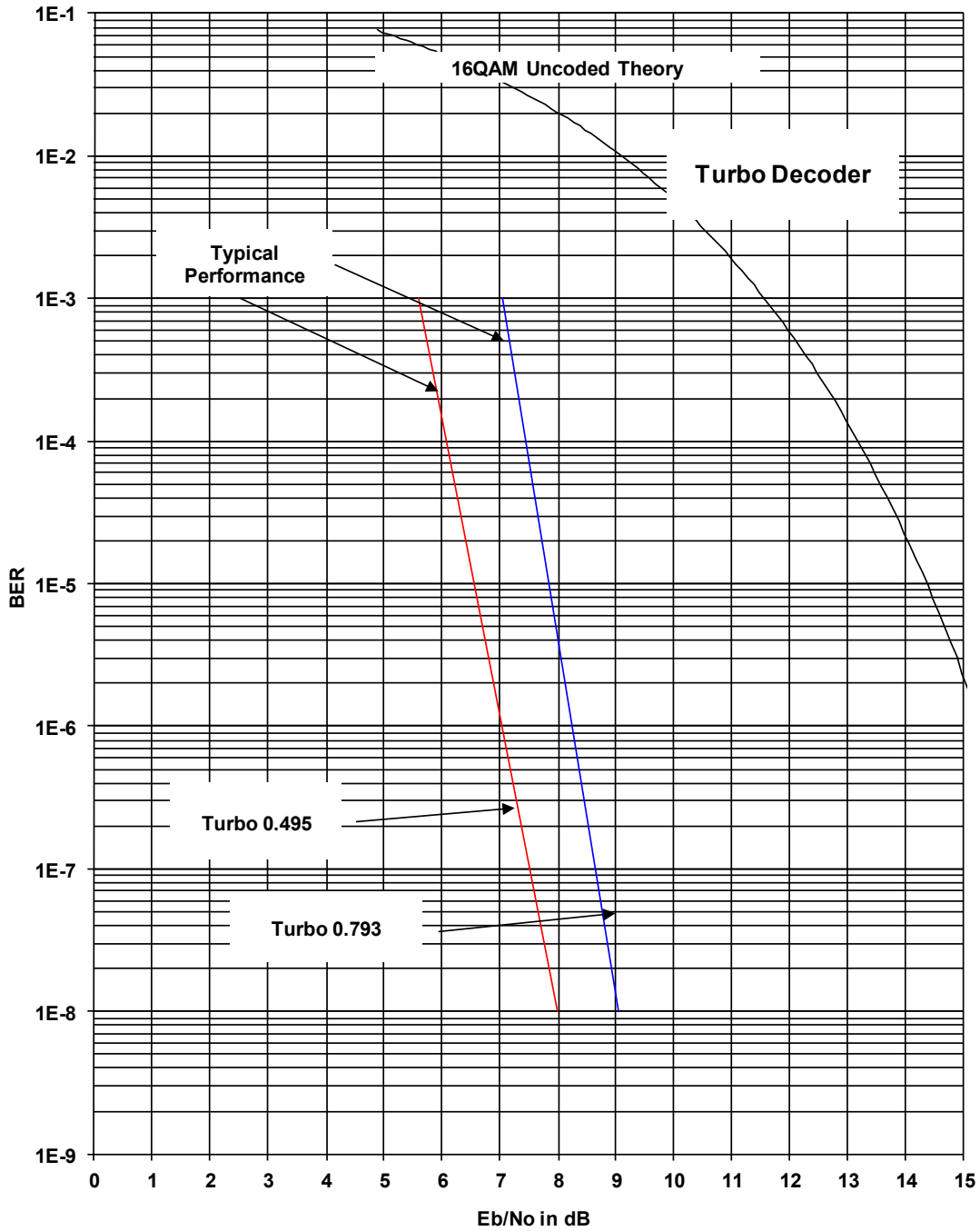

Figure 7-9 DMD20/20LBST 16QAM BER Performance (Turbo)

Note: E_b/N_0 values include the effect of using interleaving and maximum iterations.

7.20.10 BER Performance ((O)QPSK Turbo)

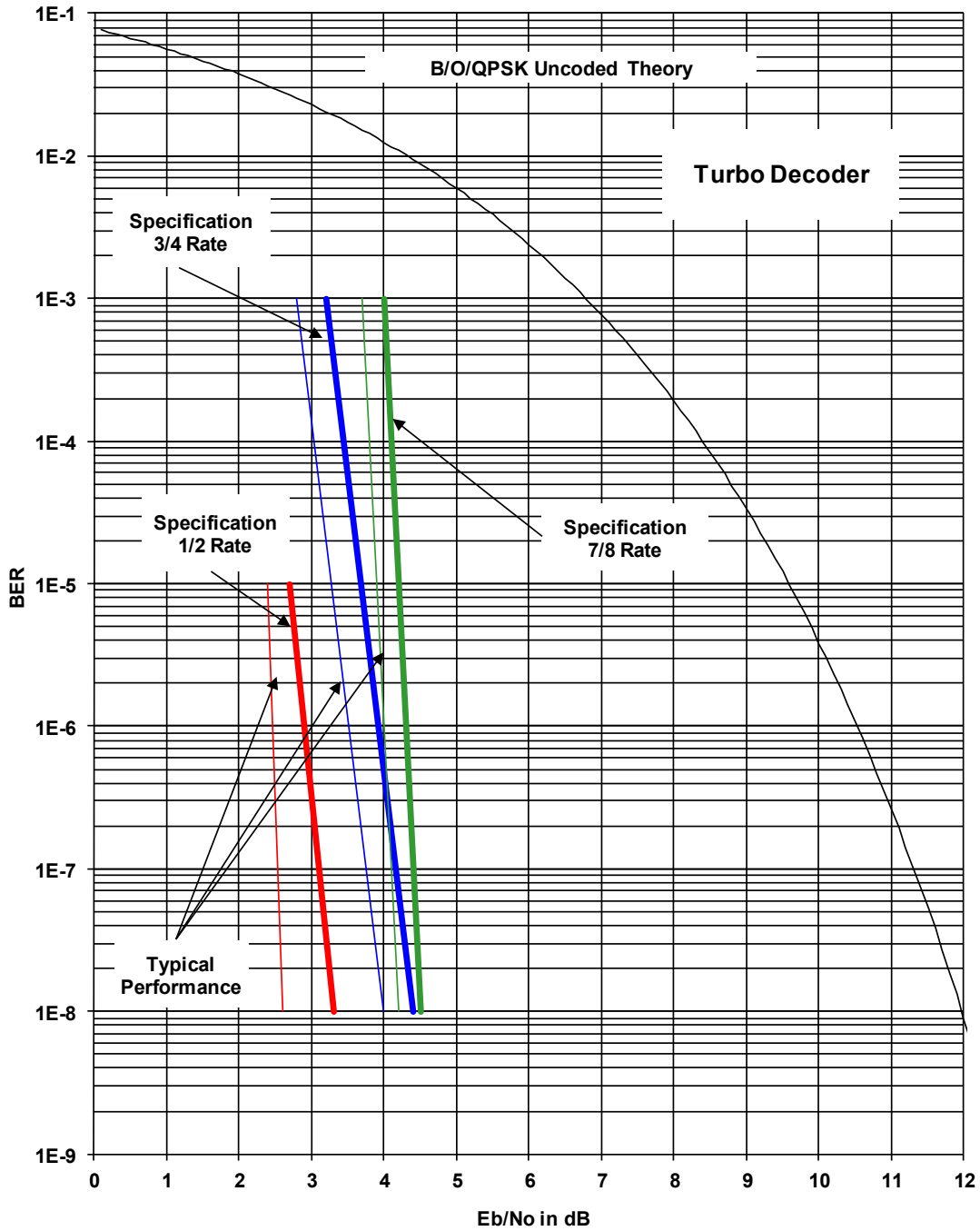

Figure 7-10 DMD20/20LBST O/QPSK BER Performance (Turbo)

7.20.11 BER Performance (BPSK Turbo)

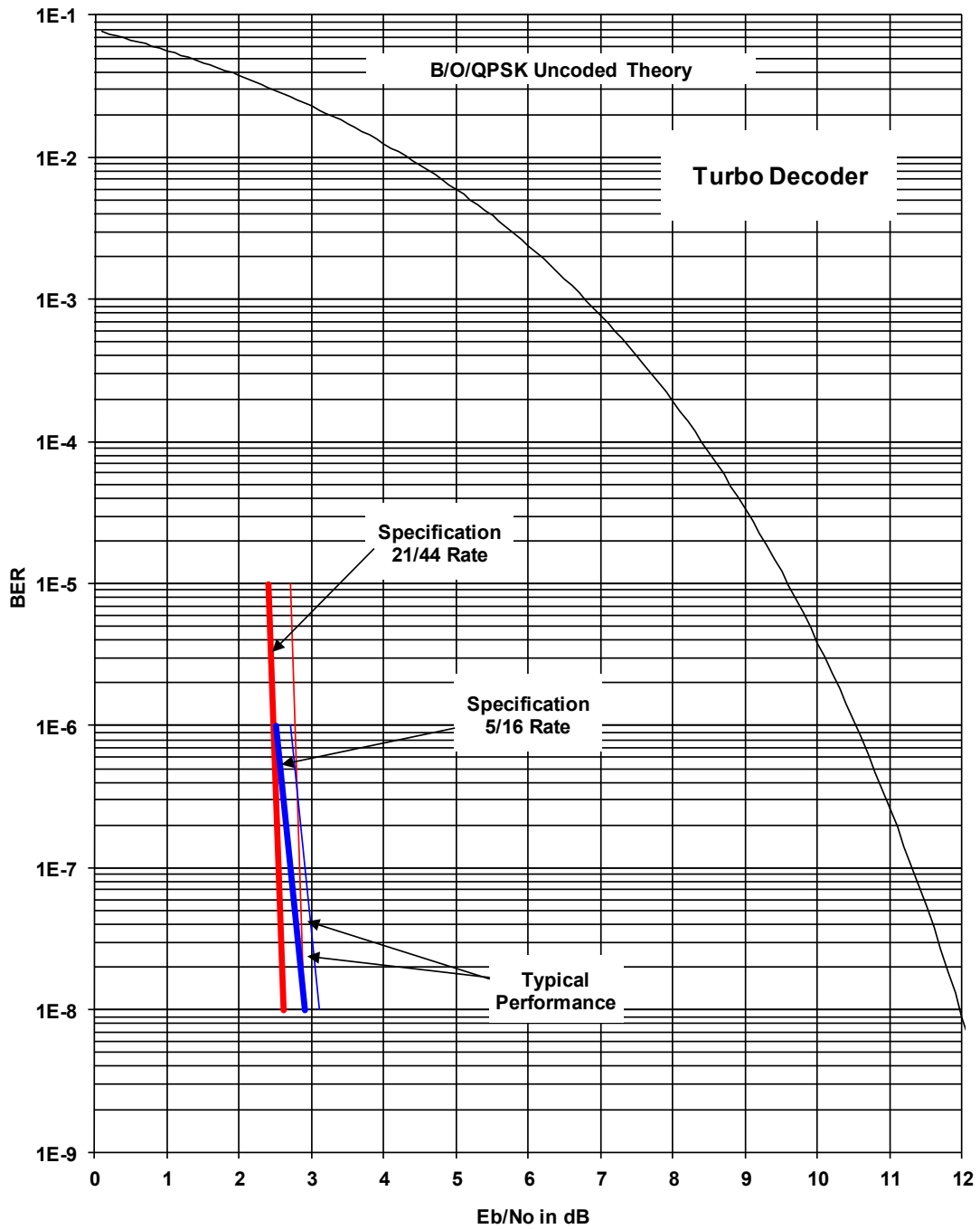

Figure 7-11 DMD20/20LBST BPSK BER Performance (Turbo)

Note: BPSK TPC 5/16 available with PL/5051 Turbo Codec Hardware.

7.20.12 BER Performance (8PSK Turbo)

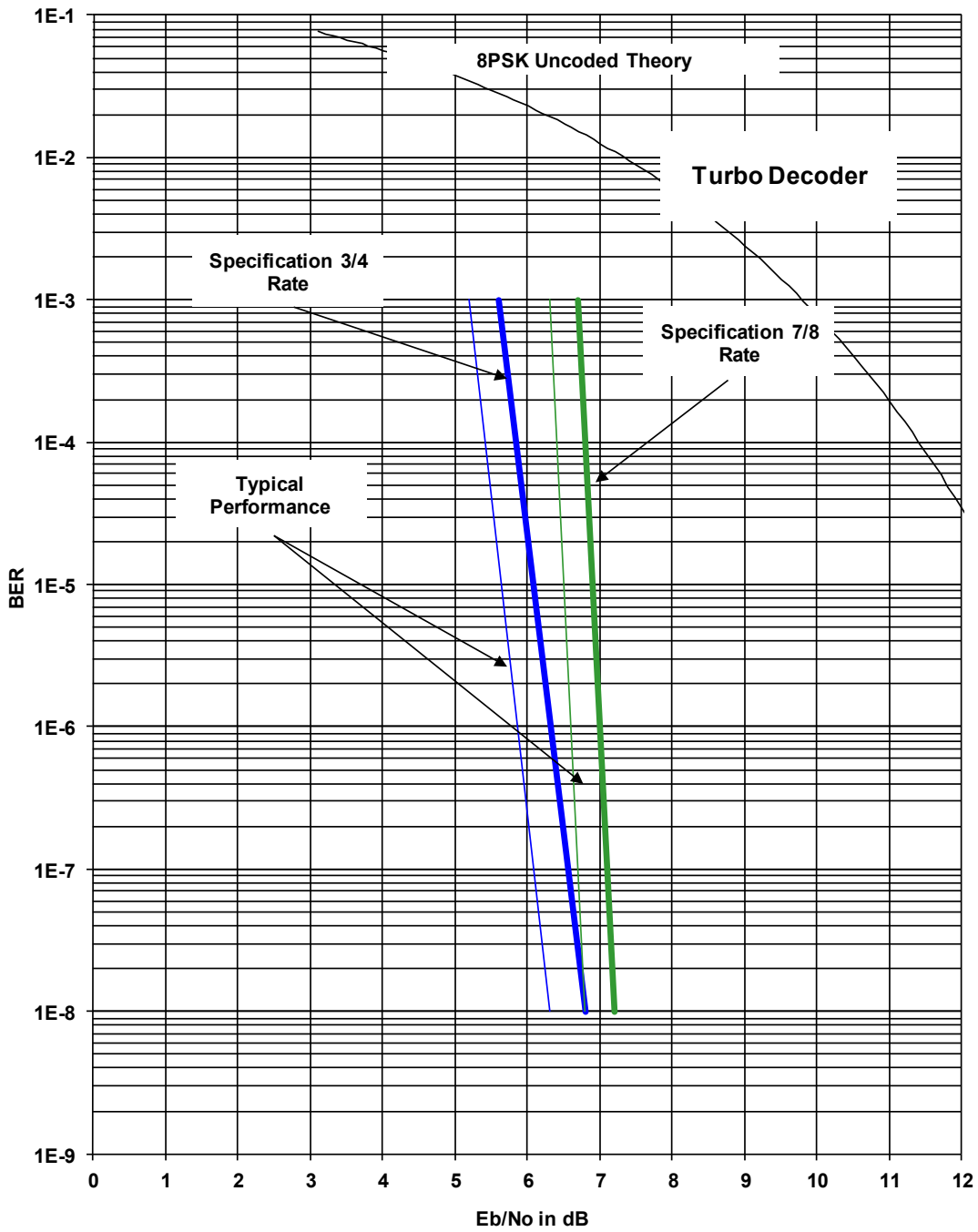

Figure 7-12 DMD20/20LBST 8PSK BER Performance (Turbo)

7.20.13 BER Performance (16QAM Turbo)

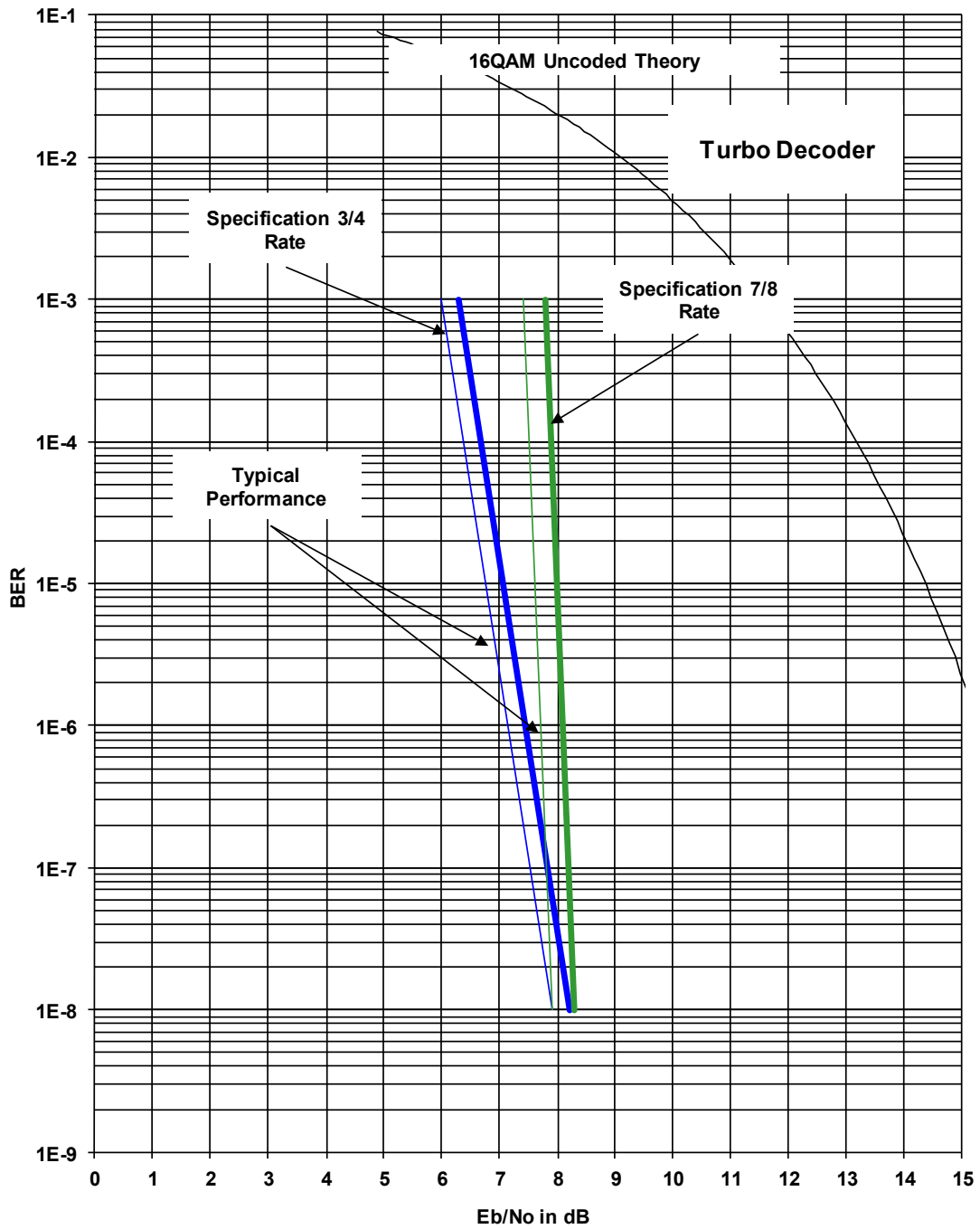

Figure 7-13 DMD20/20LBST 16QAM BER Performance (Turbo)

7.20.14 B/O/QPSK BER Performance (LDPC)

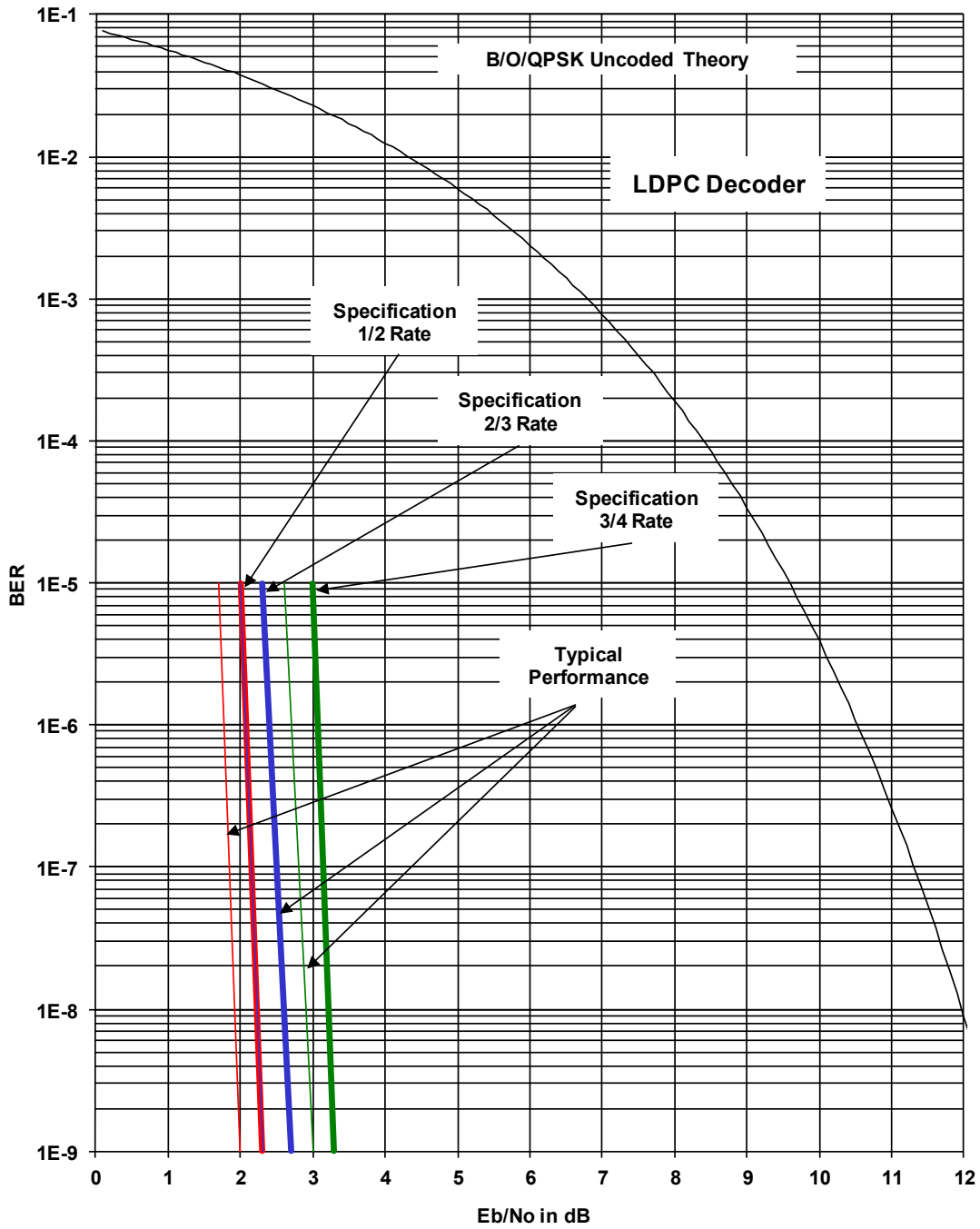

Figure 7-14 – DMD20/20LBST B/O/QPSK BER Performance (LDPC)

7.20.15 8PSK/8QAM BER Performance (LDPC)

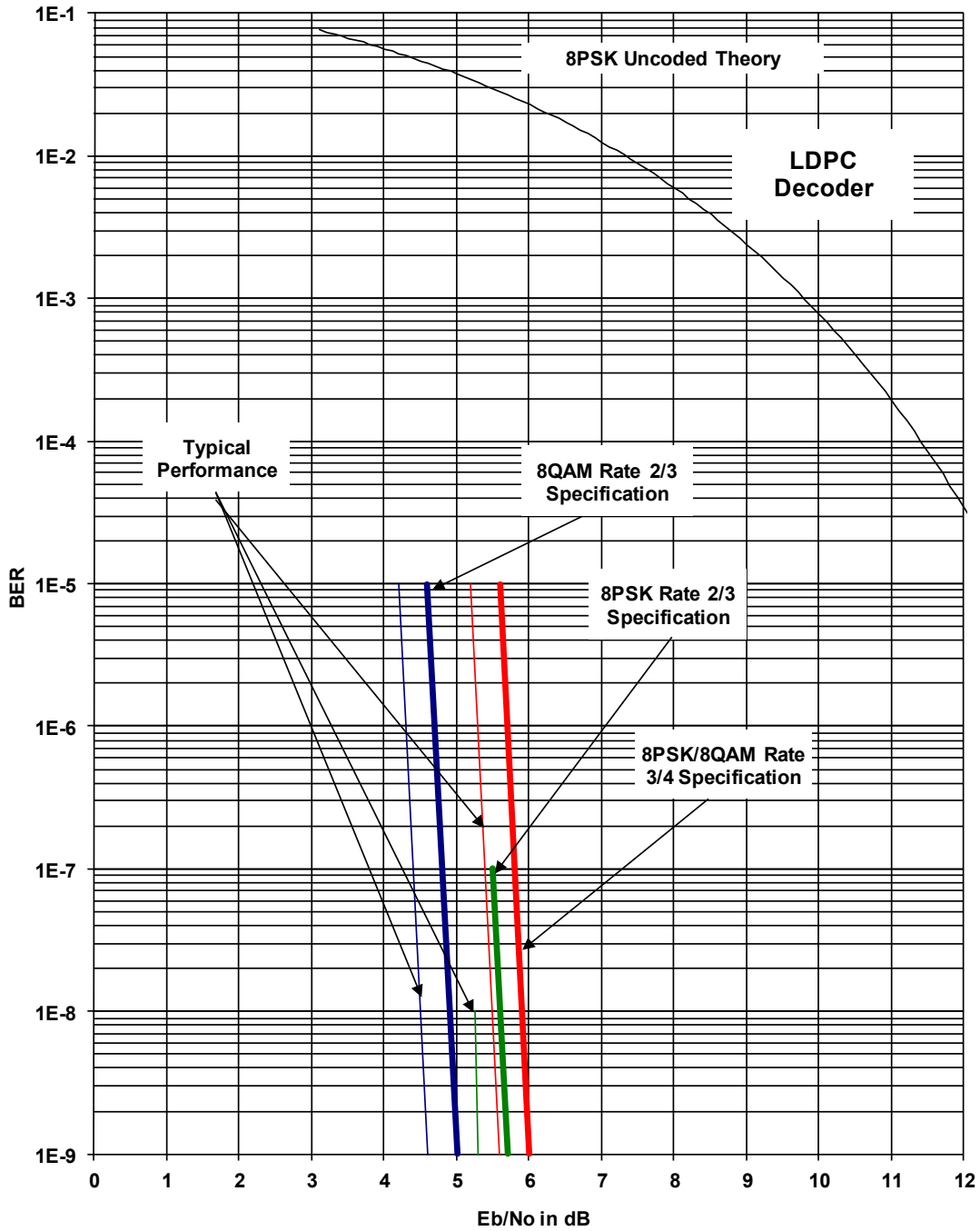

Figure 7-15 – DMD20/20LBST 8PSK/8QAM BER Performance (LDPC)

7.20.16 16QAM BER Performance (LDPC)

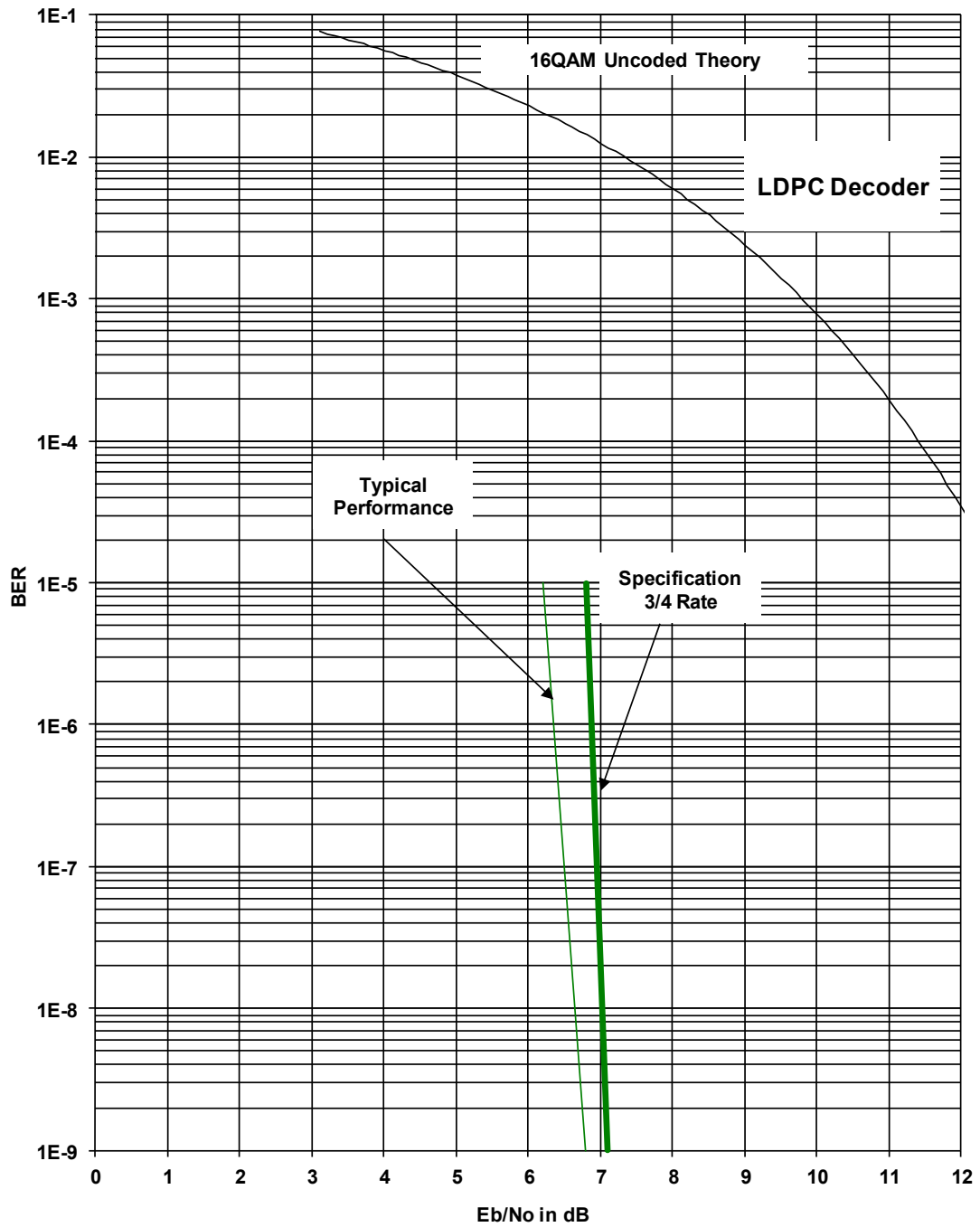

Figure 7-16 – DMD20/20LBST 16QAM BER Performance (LDPC)

Table 7-1 - B/O/QPSK BER Performance (Viterbi)						
BER	Specification			Typical		
	1/2 Rate	3/4 Rate	7/8 Rate	1/2 Rate	3/4 Rate	7/8 Rate
1E-3	4.2 dB	5.3 dB	6.2 dB	3.9 dB	4.9 dB	5.8 dB
1E-4	4.8 dB	6.1 dB	7.1 dB	4.5 dB	5.6 dB	6.5 dB
1E-5	5.5 dB	6.8 dB	7.9 dB	5.1 dB	6.3 dB	7.2 dB
1E-6	6.1 dB	7.6 dB	8.6 dB	5.7 dB	7 dB	7.9 dB
1E-7	6.7 dB	8.3 dB	9.3 dB	6.2 dB	7.7 dB	8.6 dB
1E-8	7.4 dB	8.9 dB	10.2 dB	6.8 dB	8.4 dB	9.4 dB
1E-9	8.2 dB	9.7 dB	11 dB	7.4 dB	9.1 dB	10.1 dB
1E-10	9 dB	10.3 dB	11.7 dB	8.1 dB	9.8 dB	10.5 dB

Table 7-2 - B/O/QPSK BER Performance (Sequential)						
BER	Specification			Typical		
	1/2 Rate	3/4 Rate	7/8 Rate	1/2 Rate	3/4 Rate	7/8 Rate
1E-3	4.8 dB	5.2 dB	6 dB	4.3 dB	4.7 dB	5.5 dB
1E-4	5.2 dB	5.7 dB	6.4 dB	4.7 dB	5.2 dB	5.9 dB
1E-5	5.6 dB	6.1 dB	6.9 dB	5.1 dB	5.6 dB	6.4 dB
1E-6	5.9 dB	6.5 dB	7.4 dB	5.4 dB	6.1 dB	6.9 dB
1E-7	6.3 dB	7 dB	7.9 dB	5.8 dB	6.5 dB	7.4 dB
1E-8	6.7 dB	7.4 dB	8.4 dB	6.2 dB	6.9 dB	7.9 dB
1E-9	7.1 dB	7.8 dB	8.9 dB	6.6 dB	7.4 dB	8.4 dB
1E-10	7.4 dB	8.3 dB	9.4 dB	6.9 dB	7.8 dB	8.9 dB

Table 7-3 - B/O/QPSK BER Performance (Viterbi - w/RS)						
BER	Specification			Typical		
	1/2 Rate	3/4 Rate	7/8 Rate	1/2 Rate	3/4 Rate	7/8 Rate
1E-3	3.3 dB	5.1 dB	-	3 dB	4.3 dB	5.3 dB
1E-4	3.5 dB	5.3 dB	-	3.2 dB	4.5 dB	5.7 dB
1E-5	3.8 dB	5.4 dB	6.5 dB	3.4 dB	4.7 dB	6 dB
1E-6	4.1 dB	5.6 dB	6.7 dB	3.6 dB	4.9 dB	6.4 dB
1E-7	4.2 dB	5.8 dB	6.9 dB	3.8 dB	5.1 dB	6.7 dB
1E-8	4.4 dB	6 dB	7.2 dB	4 dB	5.3 dB	7.1 dB
1E-9	4.7 dB	6.1 dB	7.5 dB	4.2 dB	5.4 dB	7.4 dB
1E-10	5 dB	6.3 dB	7.8 dB	4.4 dB	5.6 dB	7.7 dB

Table 7-4 - B/O/QPSK BER Performance (Turbo)				
BER	Specification		Typical	
	Turbo 0.495	Turbo 0.793	Turbo 0.495	Turbo 0.793
1E-3	2.5 dB	3.3 dB	2.2 dB	3 dB
1E-4	2.7 dB	3.7 dB	2.3 dB	3.2 dB
1E-5	3 dB	4.1 dB	2.5 dB	3.4 dB
1E-6	3.2 dB	4.4 dB	2.6 dB	3.6 dB
1E-7	3.5 dB	4.8 dB	2.7 dB	3.8 dB
1E-8	3.7 dB	5.2 dB	2.9 dB	4 dB
1E-9	4 dB	5.6 dB	3 dB	4.2 dB
1E-10	4.2 dB	5.9 dB	3.2 dB	4.4 dB

Table 7-5 - 8PSK BER Performance (Trellis)				
BER	Specification		Typical	
	2/3 Rate	2/3 Rate w/RS	2/3 Rate	2/3 Rate w/RS
1E-3	6.3 dB	5.8 dB	4.8 dB	4.9 dB
1E-4	7.3 dB	6.1 dB	5.6 dB	5.1 dB
1E-5	8.2 dB	6.3 dB	6.4 dB	5.4 dB
1E-6	9 dB	6.5 dB	7.2 dB	5.6 dB
1E-7	9.8 dB	6.7 dB	8.1 dB	5.8 dB
1E-8	10.4 dB	6.9 dB	8.9 dB	6.1 dB
1E-9	11.1 dB	7.1 dB	9.7 dB	6.3 dB
1E-10	11.9 dB	7.3 dB	10.5 dB	6.6 dB

Table 7-6 - 8PSK BER Performance (Turbo)				
BER	Specification		Typical	
	Turbo 0.495	Turbo 0.793	Turbo 0.495	Turbo 0.793
1E-3	-	7 dB	4.2 dB	5.4 dB
1E-4	-	7.3 dB	4.3 dB	5.6 dB
1E-5	-	7.7 dB	4.5 dB	5.9 dB
1E-6	-	8 dB	4.6 dB	6.2 dB
1E-7	-	8.4 dB	4.7 dB	6.4 dB
1E-8	-	8.7 dB	4.9 dB	6.7 dB
1E-9	-	9.1 dB	5 dB	7 dB
1E-10	-	9.5 dB	5.2 dB	7.3 dB

Table 7-7 - 16QAM BER Performance (Viterbi)				
BER	Specification		Typical	
	3/4 Rate	7/8 Rate	3/4 Rate	7/8 Rate
1E-3	8.9 dB	10.3 dB	8.1 dB	9.5 dB
1E-4	9.8 dB	11.1 dB	9 dB	10.3 dB
1E-5	10.7 dB	11.9 dB	9.9 dB	11.1 dB
1E-6	11.5 dB	12.7 dB	10.7 dB	11.9 dB
1E-7	12.4 dB	13.5 dB	11.6 dB	12.7 dB
1E-8	13.3 dB	14.3 dB	12.5 dB	13.5 dB
1E-9	14.2 dB	15.1 dB	13.4 dB	14.3 dB
1E-10	15 dB	15.9 dB	14.2 dB	15.1 dB

Table 7-8 - 16QAM BER Performance (Viterbi w/RS)				
BER	Specification		Typical	
	3/4 Rate	7/8 Rate	3/4 Rate	7/8 Rate
1E-3	8.4 dB	9.8 dB	7.8 dB	9.3 dB
1E-4	8.6 dB	8.1 dB	8.1 dB	9.6 dB
1E-5	8.9 dB	8.3 dB	8.3 dB	9.9 dB
1E-6	9.1 dB	8.6 dB	8.6 dB	10.2 dB
1E-7	9.3 dB	8.8 dB	8.8 dB	10.4 dB
1E-8	9.5 dB	9.1 dB	9.1 dB	10.7 dB
1E-9	9.8 dB	9.3 dB	9.3 dB	11 dB
1E-10	10 dB	9.6 dB	9.6 dB	11.3 dB

BER	Specification		Typical	
	Turbo 0.495	Turbo 0.793	Turbo 0.495	Turbo 0.793
1E-3	-	-	5.6 dB	7 dB
1E-4	-	-	6.1 dB	7.4 dB
1E-5	-	-	6.6 dB	7.8 dB
1E-6	-	-	7 dB	8.2 dB
1E-7	-	-	7.5 dB	8.6 dB
1E-8	-	-	8 dB	9 dB
1E-9	-	-	8.5 dB	9.4 dB
1E-10	-	-	9 dB	9.9 dB

BER	Specification			Typical		
	1/2 Rate	3/4 Rate	7/8 Rate	1/2 Rate	3/4 Rate	7/8 Rate
1E-3	-	3.2 dB	4 dB	-	2.8 dB	3.7 dB
1E-4	-	3.4 dB	4.1 dB	-	3 dB	3.8 dB
1E-5	2.7 dB	3.6 dB	4.2 dB	2.4 dB	3.2 dB	3.9 dB
1E-6	2.9 dB	3.8 dB	4.3 dB	2.6 dB	3.4 dB	4 dB
1E-7	3.1 dB	4.1 dB	4.4 dB	2.8 dB	3.7 dB	4.1 dB
1E-8	3.3 dB	4.4 dB	4.5 dB	3 dB	4 dB	4.2 dB

BER	Specification		Typical	
	5/16 Rate	21/44 Rate	5/16 Rate	21/44 Rate
1E-5	-	2.7 dB	-	2.4 dB
1E-6	2.7 dB	2.9 dB	2.5 dB	2.6 dB
1E-7	2.9 dB	3.1 dB	2.7 dB	2.8 dB
1E-8	3.1 dB	3.3 dB	2.9 dB	3 dB

BER	Specification		Typical	
	3/4 Rate	7/8 Rate	3/4 Rate	7/8 Rate
1E-3	5.6 dB	6.7 dB	5.4 dB	6.3 dB
1E-4	5.8 dB	6.8 dB	5.6 dB	6.4 dB
1E-5	6 dB	6.9 dB	5.8 dB	6.5 dB
1E-6	6.2 dB	7 dB	6 dB	6.6 dB
1E-7	6.4 dB	7.1 dB	6.2 dB	6.7 dB
1E-8	6.8 dB	7.2 dB	6.6 dB	6.8 dB

BER	Specification		Typical	
	3/4 Rate	7/8 Rate	3/4 Rate	7/8 Rate
1E-3	6.3 dB	7.8 dB	6 dB	7.4 dB
1E-4	6.7 dB	7.9 dB	6.4 dB	7.5 dB
1E-5	7 dB	8 dB	6.7 dB	7.6 dB
1E-6	7.4 dB	8.1 dB	7.1 dB	7.7 dB
1E-7	7.8 dB	8.2 dB	7.5 dB	7.8 dB
1E-8	8.2 dB	8.3 dB	7.9 dB	7.9 dB

BER	Specification		Typical	
	3/4 Rate	7/8 Rate	3/4 Rate	7/8 Rate
1E-3	6.3 dB	7.8 dB	6 dB	7.4 dB
1E-4	6.7 dB	7.9 dB	6.4 dB	7.5 dB
1E-5	7 dB	8 dB	6.7 dB	7.6 dB
1E-6	7.4 dB	8.1 dB	7.1 dB	7.7 dB
1E-7	7.8 dB	8.2 dB	7.5 dB	7.8 dB
1E-8	8.2 dB	8.3 dB	7.9 dB	7.9 dB

BER	8PSK				8-QAM			
	Specification		Typical		Specification		Typical	
	2/3 Rate	3/4 Rate	2/3 Rate	3/4 Rate	2/3 Rate	3/4 Rate	2/3 Rate	3/4 Rate
1E-5	-	5.6 dB	-	5.2 dB	4.6 dB	5.6 dB	4.2 dB	5.2 dB
1E-9	5.7 dB	6 dB	5.3 dB	5.6 dB	5 dB	6 dB	4.6 dB	5.6 dB

BER	Specification	Typical
	3/4 Rate	3/4 Rate
1E-5	6.8 dB	6.2 dB
1E-9	7.1 dB	6.8 dB

7.20.17 AGC Output Voltage

The AGC Output Voltage is a function of the Input Power Level in dBm. The AGC Output Voltage is found on the Alarm connector Pin 14 of J15.

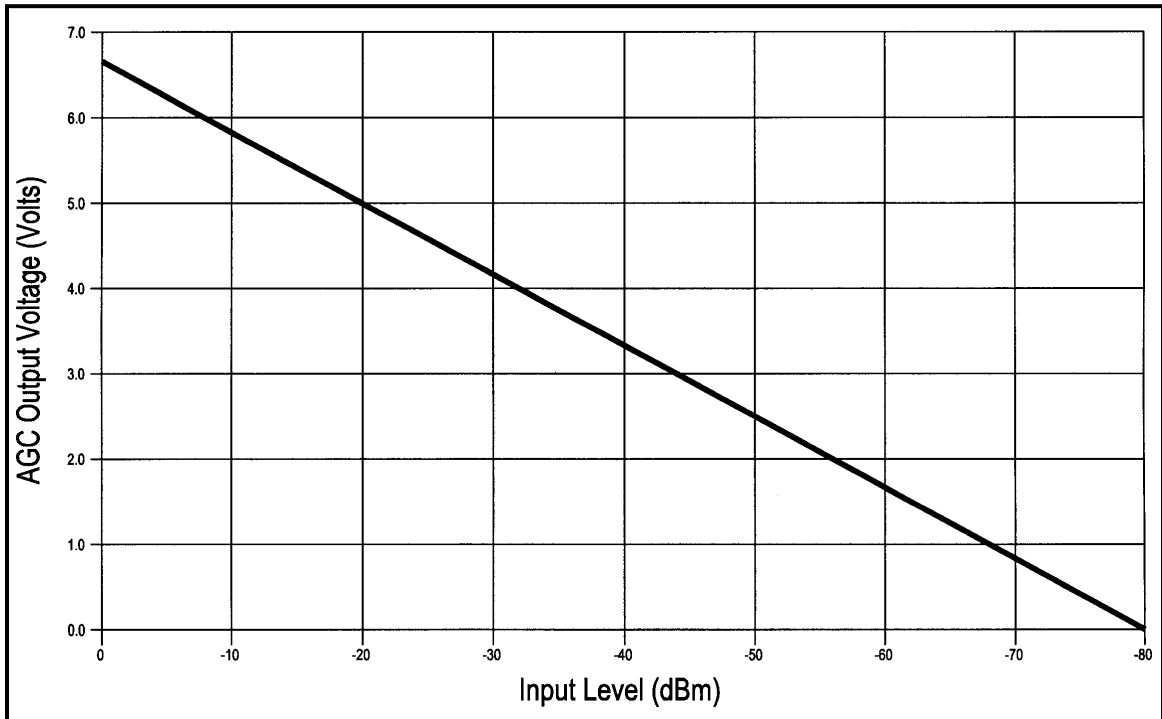

Figure 7-17 AGC Voltage Monitor

BLANK PAGE

Errata B for MN-DMD20-20LBST Rev 14

Comtech EF Data Documentation Update

DMD20/DMD20LBST

**Universal Satellite Modem
Installation and Operation Manual**

Part Number MN-DMD20-20LBST

Revision 14

Subject: Chapter 3, Theory of Operation

Errata Part Number: ER-DMD20LBS-EB14 (*Errata documents are not subject to revision.*)

PLM CO Number: C-0028800

Comments: The new information will be included in the next released revision of the manual.



IMPORTANT

Set the modem to Loop Timing mode for these Loopback operations:

- Tx/Rx Terrestrial Loopback
- Tx/Rx Baseband Loopback
- Rx Baseband Loopback

Blank Page

Errata C for MN-DMD20-20LBST Rev 14

Comtech EF Data Documentation Update
DMD20/DMD20LBST

**Universal Satellite Modem
Installation and Operation Manual**

Part Number MN-DMD20-20LBST

Revision 14

Subject: Add Appendix K, Compatibility with other DMD Modems

Errata Part Number: ER-DMD20LBS-EC14 (*Errata documents are not subject to revision.*)

Comments: The new information will be included in the next released revision of the manual.

Blank Page

Appendix K. Compatibility with Other DMD Modems

K.1 Compatibility with Other DMD Modems

Modulation	Code	Rate	Data Rate Range (kbps)	DMD20 / DMD20 LBST HW1 + HW6	DMD1050 / DMD1050T / DMD1050TS HW3 + HW8	OM20 HW1 + HW6	Data Rate Range (kbps)	DMD50 / DMD2050 HW2 + HW7	DMD2050E / DMD2050EU HW2 + HW7 + HW24
Legacy Modes									
BPSK	Viterbi	1/2	2.4 – 5,000	Standard	Standard	Standard	2.4 – 15,000	Standard	Standard
QPSK	Viterbi	1/2	4.8 – 10,000	Standard	Standard	Standard	4.8 – 30,000	Standard	Standard
		3/4	7.2 – 15,000	Standard	Standard	Standard	7.2 – 45,000	Standard	Standard
		7/8	8.4 – 17,500	Standard	Standard	Standard	8.4 – 52,000	Standard	Standard
	Viterbi + RS	1/2	4.8 – 10,000 * R / N	RS Feature	RS Feature	RS Feature	4.8 – 30,000 * R / N	RS Feature	Standard
		3/4	7.2 – 15,000 * R / N	RS Feature	RS Feature	RS Feature	7.2 – 45,000 * R / N	RS Feature	Standard
		7/8	8.4 – 17,500 * R / N	RS Feature	RS Feature	RS Feature	8.4 – 52,000 * R / N	RS Feature	Standard
	Sequential	1/2	4.8 – 2,048	Sequential Feature	Sequential Feature	Sequential Feature	4.8 – 2,048	Sequential Feature	Sequential Feature
		3/4	7.2 – 2,048	Sequential Feature	Sequential Feature	Sequential Feature	7.2 – 2,048	Sequential Feature	Sequential Feature
		7/8	8.4 – 2,048	Sequential Feature	Sequential Feature	Sequential Feature	8.4 – 2,048	Sequential Feature	Sequential Feature
OQPSK	Viterbi	1/2	4.8 – 10,000	Standard	Standard	Standard	4.8 – 30,000	Standard	Standard
		3/4	7.2 – 15,000	Standard	Standard	Standard	7.2 – 45,000	Standard	Standard
		7/8	8.4 – 17,500	Standard	Standard	Standard	8.4 – 52,000	Standard	Standard
	Viterbi + RS	1/2	4.8 – 10,000 * R / N	RS Feature	RS Feature	RS Feature	4.8 – 10,000 * R / N	RS Feature	Standard
		3/4	7.2 – 15,000 * R / N	RS Feature	RS Feature	RS Feature	7.2 – 15,000 * R / N	RS Feature	Standard
		7/8	8.4 – 17,500 * R / N	RS Feature	RS Feature	RS Feature	8.4 – 17,500 * R / N	RS Feature	Standard
	Sequential	1/2	4.8 – 2,048	Sequential Feature	Sequential Feature	Sequential Feature	4.8 – 2,048	Sequential Feature	Sequential Feature
		3/4	7.2 – 2,048	Sequential Feature	Sequential Feature	Sequential Feature	7.2 – 2,048	Sequential Feature	Sequential Feature
		7/8	8.4 – 2,048	Sequential Feature	Sequential Feature	Sequential Feature	8.4 – 2,048	Sequential Feature	Sequential Feature
8PSK	Trellis	2/3	9.6 – 20,000	8PSK Feature	8PSK Feature	8PSK Feature	9.6 – 52,000	8PSK Feature	Standard
	Trellis + RS	2/3	9.6 – 20,000 * R / N	8PSK + RS Feature	8PSK + RS Feature	8PSK + RS Feature	9.6 – 52,000	8PSK + RS Feature	Standard
16QAM	Viterbi	3/4	14.4 – 20,000	16QAM Feature	16QAM Feature	16QAM Feature	14.4 – 52,000	16QAM Feature	Standard
		7/8	16.8 – 20,000	16QAM Feature	16QAM Feature	16QAM Feature	16.8 – 52,000	16QAM Feature	Standard

Modulation	Code	Rate	Data Rate Range (kbps)	DMD20 / DMD20 LBST HW1 + HW6	DMD1050 / DMD1050T / DMD1050TS HW3 + HW8	OM20 HW1 + HW6	Data Rate Range (kbps)	DMD50 / DMD2050 HW2 + HW7	DMD2050E / DMD2050EU HW2 + HW7 + HW24
	Viterbi + RS	3/4	14.4 – 20,000 * R / N	16QAM + RS Feature	16QAM + RS Feature	16QAM + RS Feature	14.4 – 52,000	16QAM + RS Feature	Standard
		7/8	16.8 – 20,000 * R / N	16QAM + RS Feature	16QAM + RS Feature	16QAM + RS Feature	16.8 – 52,000	16QAM + RS Feature	Standard
DVB Modes									
BPSK	Viterbi	1/2	2.4 – 4,608	DVB Feature	DVB Feature	DVB Feature	2.4 – 4,608	DVB Feature	DVB Feature
		2/3	3.2 – 6,144	DVB Feature	DVB Feature	DVB Feature	3.2 – 6,144	DVB Feature	DVB Feature
		3/4	3.6 – 6,912	DVB Feature	DVB Feature	DVB Feature	3.6 – 6,912	DVB Feature	DVB Feature
		5/6	4.0 – 7,680	DVB Feature	DVB Feature	DVB Feature	4.0 – 7,680	DVB Feature	DVB Feature
		7/8	4.2 – 8,064	DVB Feature	DVB Feature	DVB Feature	4.2 – 8,064	DVB Feature	DVB Feature
QPSK	Viterbi	1/2	4.8 – 9,216	DVB Feature	DVB Feature	DVB Feature	4.8 – 9,216	DVB Feature	DVB Feature
		2/3	6.4 – 12,288	DVB Feature	DVB Feature	DVB Feature	6.4 – 12,288	DVB Feature	DVB Feature
		3/4	7.2 – 13,824	DVB Feature	DVB Feature	DVB Feature	7.2 – 13,824	DVB Feature	DVB Feature
		5/6	8.0 – 15,359	DVB Feature	DVB Feature	DVB Feature	8.0 – 15,359	DVB Feature	DVB Feature
		7/8	8.4 – 16,127	DVB Feature	DVB Feature	DVB Feature	8.4 – 16,127	DVB Feature	DVB Feature
8PSK	Trellis	2/3	9.6 – 18,431	8PSK + DVB Feature	8PSK + DVB Feature	8PSK + DVB Feature	9.6 – 18,431	8PSK + DVB Feature	DVB Feature
		5/6	12.0 – 20,000	8PSK + DVB Feature	8PSK + DVB Feature	8PSK + DVB Feature	12.0 – 20,000	8PSK + DVB Feature	DVB Feature
		8/9	12.8 – 20,000	8PSK + DVB Feature	8PSK + DVB Feature	8PSK + DVB Feature	12.8 – 20,000	8PSK + DVB Feature	DVB Feature
16QAM	Trellis	3/4	14.4 – 20,000	16QAM + DVB Feature	16QAM + DVB Feature	16QAM + DVB Feature	14.4 – 20,000	16QAM + DVB Feature	DVB Feature
		7/8	16.8 – 20,000	16QAM + DVB Feature	16QAM + DVB Feature	16QAM + DVB Feature	16.8 – 20,000	16QAM + DVB Feature	DVB Feature
TPC Modes									
BPSK	TPC	5/16	1.5 – 3,125	TPC Feature + HW16	TPC Feature + HW18	—	1.5 – 9,375	TPC Feature + HW16	Standard
		21/44	2.3 – 4,773	TPC Feature + HW14	TPC Feature	TPC Feature	2.3 – 14,318	TPC Feature + HW14	Standard
	TPC (SHORT)	7/8-S	4.2 – 8,750	TPC Feature + HW15	—	—	4.2 – 20,000	TPC Feature + HW15	—
QPSK	TPC	21/44	4.6 – 9,545	TPC Feature + HW14	TPC Feature	TPC Feature	4.6 – 20,000	TPC Feature + HW14	Standard
		3/4	7.2 – 15,000	TPC Feature + HW14	TPC Feature	TPC Feature	7.2 – 20,000	TPC Feature + HW14	Standard

Modulation	Code	Rate	Data Rate Range (kbps)	DMD20 / DMD20 LBST HW1 + HW6	DMD1050 / DMD1050T / DMD1050TS HW3 + HW8	OM20 HW1 + HW6	Data Rate Range (kbps)	DMD50 / DMD2050 HW2 + HW7	DMD2050E / DMD2050EU HW2 + HW7 + HW24
		7/8	8.4 – 17,500	TPC Feature + HW14	TPC Feature	TPC Feature	8.4 – 20,000	TPC Feature + HW14	Standard
		0.495	64.0 – 6,132	TPC Feature + HW15	—	—	64.0 – 6,132	TPC Feature + HW15	—
		0.793	64.0 – 6,132	TPC Feature + HW15	—	—	64.0 – 6,132	TPC Feature + HW15	—
	TPC (SHORT)	7/8-S	64.0 – 17,500	TPC Feature + HW15	—	—	64.0 – 20,000	TPC Feature + HW15	—
OQPSK	TPC	21/44	4.6 – 9,545	TPC Feature + HW-2	TPC Feature	TPC Feature	4.6 – 20,000	TPC Feature + HW14	Standard
		3/4	7.2 – 15,000	TPC Feature + HW-2	TPC Feature	TPC Feature	7.2 – 20,000	TPC Feature + HW14	Standard
		7/8	8.4 – 17,500	TPC Feature + HW-2	TPC Feature	TPC Feature	8.4 – 20,000	TPC Feature + HW14	Standard
		0.495	64.0 – 6,132	TPC Feature + HW15	—	—	64.0 – 6,132	TPC Feature + HW15	—
		0.793	64.0 – 6,132	TPC Feature + HW15	—	—	64.0 – 6,132	TPC Feature + HW15	—
	TPC (SHORT)	7/8-S	64.0 – 17,500	TPC Feature + HW15	—	—	64.0 – 20,000	TPC Feature + HW15	—
8PSK	TPC	3/4	10.8 – 20,000	8PSK + TPC Feature + HW14	8PSK + TPC Feature	8PSK + TPC Feature	10.8 – 20,000	8PSK + TPC Feature + HW14	Standard
		7/8	12.6 – 20,000	8PSK + TPC Feature + HW14	8PSK + TPC Feature	8PSK + TPC Feature	12.6 – 20,000	8PSK + TPC Feature + HW14	Standard
		0.495	64.0 – 6,132	8PSK + TPC Feature + HW15	—	—	64.0 – 6,132	8PSK + TPC Feature + HW15	—
		0.793	64.0 – 6,132	8PSK + TPC Feature + HW15	—	—	64.0 – 6,132	8PSK + TPC Feature + HW15	—
		0.750	—	—	—	—	20,000.1 – 52,000	8PSK + TPC Feature + HW15	—
		0.875	—	—	—	—	20,000.1 – 52,000	8PSK + TPC Feature + HW15	—
8QAM	TPC	3/4	10.8 – 20,000	8QAM + TPC Feature + HW16	8QAM + TPC Feature + HW18	—	10.8 – 20,000	8QAM + TPC Feature + HW16	Standard
		7/8	12.6 – 20,000	8QAM + TPC Feature +	8QAM + TPC Feature +	—	12.6 – 20,000	8QAM + TPC Feature +	Standard

Modulation	Code	Rate	Data Rate Range (kbps)	DMD20 / DMD20 LBST HW1 + HW6	DMD1050 / DMD1050T / DMD1050TS HW3 + HW8	OM20 HW1 + HW6	Data Rate Range (kbps)	DMD50 / DMD2050 HW2 + HW7	DMD2050E / DMD2050EU HW2 + HW7 + HW24
				HW16	HW18			HW16	
16QAM	TPC	3/4	14.4 – 20,000	16QAM + TPC Feature + HW14	16QAM + TPC Feature	16QAM + TPC Feature	14.4 – 20,000	16QAM + TPC Feature + HW14	Standard
		7/8	16.8 – 20,000	16QAM + TPC Feature + HW14	16QAM + TPC Feature	16QAM + TPC Feature	16.8 – 20,000	16QAM + TPC Feature + HW14	Standard
		0.495	64.0 – 6,132	16QAM + TPC Feature + HW15	—	—	64.0 – 6,132	16QAM + TPC Feature + HW15	—
		0.793	64.0 – 6,132	16QAM + TPC Feature + HW15	—	—	64.0 – 6,132	16QAM + TPC Feature + HW15	—
		0.750	—	—	—	—	20,000.1 – 52,000	16QAM + TPC Feature + HW15	—
		0.875	—	—	—	—	20,000.1 – 52,000	16QAM + TPC Feature + HW15	—
165B Turbo Modes									
BPSK	Turbo	1/2	64 – 5,000	—	EBEM Feature + HW17	—	64 – 15,000	EBEM Feature + HW17	Standard
		2/3	64 – 6,667	—	EBEM Feature + HW17	—	64 – 20,000	EBEM Feature + HW17	Standard
		3/4	64 – 7,500	—	EBEM Feature + HW17	—	64 – 22,500	EBEM Feature + HW17	Standard
		7/8	64 – 8,750	—	EBEM Feature + HW17	—	64 – 26,250	EBEM Feature + HW17	Standard
		19/20	64 – 9,500	—	EBEM Feature + HW17	—	64 – 28,500	EBEM Feature + HW17	Standard
QPSK	Turbo	1/2	64 – 10,000	—	EBEM Feature + HW17	—	64 – 30,000	EBEM Feature + HW17	Standard
		2/3	64 – 13,333	—	EBEM Feature + HW17	—	64 – 40,000	EBEM Feature + HW17	Standard
		3/4	64 – 15,000	—	EBEM Feature + HW17	—	64 – 45,000	EBEM Feature + HW17	Standard
		7/8	64 – 17,500	—	EBEM Feature + HW17	—	64 – 52,500	EBEM Feature + HW17	Standard
		19/20	64 – 19,000	—	EBEM Feature + HW17	—	64 – 57,000	EBEM Feature + HW17	Standard
8PSK	Turbo	1/2	256 – 15,000	—	EBEM Feature + HW17	—	256 – 45,000	EBEM Feature + HW17	Standard

Modulation	Code	Rate	Data Rate Range (kbps)	DMD20 / DMD20 LBST HW1 + HW6	DMD1050 / DMD1050T / DMD1050TS HW3 + HW8	OM20 HW1 + HW6	Data Rate Range (kbps)	DMD50 / DMD2050 HW2 + HW7	DMD2050E / DMD2050EU HW2 + HW7 + HW24
		2/3	256 – 20,000	—	EBEM Feature + HW17	—	256 – 60,000	EBEM Feature + HW17	Standard
		3/4	256 – 20,000	—	EBEM Feature + HW17	—	256 – 67,500	EBEM Feature + HW17	Standard
		7/8	256 – 20,000	—	EBEM Feature + HW17	—	256 – 78,750	EBEM Feature + HW17	Standard
		19/20	256 – 20,000	—	EBEM Feature + HW17	—	256 – 85,500	EBEM Feature + HW17	Standard
16APSK	Turbo	1/2	256 – 20,000	—	EBEM Feature + HW17	—	256 – 60,000	EBEM Feature + HW17	Standard
		2/3	256 – 20,000	—	EBEM Feature + HW17	—	256 – 80,000	EBEM Feature + HW17	Standard
		3/4	256 – 20,000	—	EBEM Feature + HW17	—	256 – 90,000	EBEM Feature + HW17	Standard
		7/8	256 – 20,000	—	EBEM Feature + HW17	—	256 – 105,000	EBEM Feature + HW17	Standard
		19/20	256 – 20,000	—	EBEM Feature + HW17	—	256 – 114,000	EBEM Feature + HW17	Standard
LDPC Modes									
BPSK	HP-LDPC	1/2	2.4 – 5,000	LDPC Feature + HW16	LDPC Feature + HW18	LDPC Feature + HW20	2.4 – 15,000	LDPC Feature + HW16	LDPC Feature
	ULL-LDPC	1/2	2.4 – 4,933	LDPC Feature + HW19	—	LDPC Feature + HW20	2.4 – 14,799	LDPC Feature + HW19	LDPC Feature
QPSK	HP-LDPC	1/2	4.8 – 10,000	LDPC Feature + HW16	LDPC Feature + HW18	LDPC Feature + HW20	4.8 – 20,000	LDPC Feature + HW16	LDPC Feature
		2/3	6.4 – 13,333	LDPC Feature + HW16	LDPC Feature + HW18	LDPC Feature + HW20	6.4 – 20,000	LDPC Feature + HW16	LDPC Feature
		3/4	7.2 – 15,000	LDPC Feature + HW16	LDPC Feature + HW18	LDPC Feature + HW20	7.2 – 20,000	LDPC Feature + HW16	LDPC Feature
	ULL-LDPC	1/2	4.7 – 9,866	LDPC Feature + HW19	—	LDPC Feature + HW20	4.7 – 20,000	LDPC Feature + HW19	LDPC Feature
		2/3	6.3 – 13,078	LDPC Feature + HW19	—	LDPC Feature + HW20	6.3 – 20,000	LDPC Feature + HW19	LDPC Feature
		3/4	7.0 – 14,685	LDPC Feature + HW19	—	LDPC Feature + HW20	7.0 – 20,000	LDPC Feature + HW19	LDPC Feature
OQPSK	HP-LDPC	1/2	4.8 – 10,000	LDPC Feature + HW16	LDPC Feature + HW18	LDPC Feature + HW20	4.8 – 20,000	LDPC Feature + HW16	LDPC Feature
		2/3	6.4 – 13,333	LDPC Feature + HW16	LDPC Feature + HW18	LDPC Feature + HW20	6.4 – 20,000	LDPC Feature + HW16	LDPC Feature
		3/4	7.2 – 15,000	LDPC Feature + HW16	LDPC Feature + HW18	LDPC Feature + HW20	7.2 – 20,000	LDPC Feature + HW16	LDPC Feature
	ULL-LDPC	1/2	4.7 – 9,866	LDPC Feature + HW19	—	LDPC Feature + HW20	4.7 – 20,000	LDPC Feature + HW19	LDPC Feature
		2/3	6.3 – 13,078	LDPC Feature + HW19	—	LDPC Feature + HW20	6.3 – 20,000	LDPC Feature + HW19	LDPC Feature
		3/4	7.0 – 14,685	LDPC Feature + HW19	—	LDPC Feature + HW20	7.0 – 20,000	LDPC Feature + HW19	LDPC Feature

Modulation	Code	Rate	Data Rate Range (kbps)	DMD20 / DMD20 LBST HW1 + HW6	DMD1050 / DMD1050T / DMD1050TS HW3 + HW8	OM20 HW1 + HW6	Data Rate Range (kbps)	DMD50 / DMD2050 HW2 + HW7	DMD2050E / DMD2050EU HW2 + HW7 + HW24
8PSK	HP-LDPC	2/3	9.6 – 20,000	8PSK + LDPC Feature + HW16	8PSK + LDPC Feature + HW18	8PSK + LDPC Feature + HW20	9.6 – 20,000	8PSK + LDPC Feature + HW20	LDPC Feature
		3/4	10.8 – 20,000	8PSK + LDPC Feature + HW16	8PSK + LDPC Feature + HW18	8PSK + LDPC Feature + HW20	10.8 – 20,000	8PSK + LDPC Feature + HW16	LDPC Feature
8QAM	HP-LDPC	2/3	9.6 – 20,000	8QAM + LDPC Feature + HW16	8QAM + LDPC Feature + HW18	8QAM + LDPC Feature + HW20	9.6 – 20,000	8QAM + LDPC Feature + HW16	LDPC Feature
		3/4	10.8 – 20,000	8QAM + LDPC Feature + HW16	8QAM + LDPC Feature + HW18	8QAM + LDPC Feature + HW20	10.8 – 20,000	8QAM + LDPC Feature + HW16	LDPC Feature
16QAM	HP-LDPC	3/4	14.4 – 20,000	16QAM + LDPC Feature + HW16	16QAM + LDPC Feature + HW18	16QAM + LDPC Feature + HW20	14.4 – 20,000	16QAM + LDPC Feature + HW16	LDPC Feature
TX Direct Sequence Spread Spectrum									
BPSK	HP-LDPC-OFF	1/2	2.4 – 5,000	LDPC Feature + HW19	—	LDPC Feature + HW20	2.4 – 15,000	LDPC Feature + HW19	DSSS Feature + LDPC Feature
	FACTOR x2		2.4 – 2,500	LDPC Feature + HW19	—	LDPC Feature + HW20	2.4 – 7,500	LDPC Feature + HW19	DSSS Feature + LDPC Feature
	FACTOR x4		2.4 – 1,250	LDPC Feature + HW19	—	LDPC Feature + HW20	2.4 – 3,750	LDPC Feature + HW19	DSSS Feature + LDPC Feature
	FACTOR x8		2.4 – 625	LDPC Feature + HW19	—	LDPC Feature + HW20	2.4 – 1,875	LDPC Feature + HW19	DSSS Feature + LDPC Feature
	FACTOR x16		2.4 – 313	LDPC Feature + HW19	—	LDPC Feature + HW20	2.4 – 937	LDPC Feature + HW19	DSSS Feature + LDPC Feature
	HP-LDPC-OFF	1/2	2.4 – 4,933	LDPC Feature + HW19	—	LDPC Feature + HW20	2.4 – 4,933	LDPC Feature + HW19	DSSS Feature + LDPC Feature
	FACTOR x2		2.4 – 2,467	LDPC Feature + HW19	—	LDPC Feature + HW20	2.4 – 2,466	LDPC Feature + HW19	DSSS Feature + LDPC Feature

Modulation	Code	Rate	Data Rate Range (kbps)	DMD20 / DMD20 LBST HW1 + HW6	DMD1050 / DMD1050T / DMD1050TS HW3 + HW8	OM20 HW1 + HW6	Data Rate Range (kbps)	DMD50 / DMD2050 HW2 + HW7	DMD2050E / DMD2050EU HW2 + HW7 + HW24
	FACTOR x4		2.4 – 1,233	LDPC Feature + HW19	—	LDPC Feature + HW20	2.4 – 1,233	LDPC Feature + HW19	DSSS Feature + LDPC Feature
	FACTOR x8		2.4 - 617	LDPC Feature + HW19	—	LDPC Feature + HW20	2.4 - 616	LDPC Feature + HW19	DSSS Feature + LDPC Feature
	FACTOR x16		2.4 - 308	LDPC Feature + HW19	—	LDPC Feature + HW20	2.4 - 308	LDPC Feature + HW19	DSSS Feature + LDPC Feature
QPSK	HP-LDPC-OFF	1/2	4.8 – 10,000	LDPC Feature + HW19	—	LDPC Feature + HW20	4.8 – 10,000	LDPC Feature + HW19	DSSS Feature + LDPC Feature
	FACTOR x2		4.8 – 5,000	LDPC Feature + HW19	—	LDPC Feature + HW20	4.8 – 5,000	LDPC Feature + HW19	DSSS Feature + LDPC Feature
	FACTOR x4		4.8 – 2,500	LDPC Feature + HW19	—	LDPC Feature + HW20	4.8 – 2,500	LDPC Feature + HW19	DSSS Feature + LDPC Feature
	FACTOR x8		4.8 – 1,250	LDPC Feature + HW19	—	LDPC Feature + HW20	4.8 – 1,250	LDPC Feature + HW19	DSSS Feature + LDPC Feature
	FACTOR x16		4.8 - 625	LDPC Feature + HW19	—	LDPC Feature + HW20	4.8 – 625	LDPC Feature + HW19	DSSS Feature + LDPC Feature
	HP-LDPC-OFF	1/2	4.7 – 9,866	LDPC Feature + HW19	—	LDPC Feature + HW20	4.7 – 9,866	LDPC Feature + HW19	DSSS Feature + LDPC Feature
	FACTOR x2		4.7 – 4,933	LDPC Feature + HW19	—	LDPC Feature + HW20	4.7 – 4,933	LDPC Feature + HW19	DSSS Feature + LDPC Feature
	FACTOR x4		4.7 – 2,467	LDPC Feature + HW19	—	LDPC Feature + HW20	4.7 – 2,466	LDPC Feature + HW19	DSSS Feature + LDPC Feature
	FACTOR x8		4.7 – 1,233	LDPC Feature + HW19	—	LDPC Feature + HW20	4.7 – 1,233	LDPC Feature + HW19	DSSS Feature + LDPC Feature
	FACTOR x16		4.7 - 617	LDPC Feature + HW19	—	LDPC Feature + HW20	4.7 – 616	LDPC Feature + HW19	DSSS Feature +

Modulation	Code	Rate	Data Rate Range (kbps)	DMD20 / DMD20 LBST HW1 + HW6	DMD1050 / DMD1050T / DMD1050TS HW3 + HW8	OM20 HW1 + HW6	Data Rate Range (kbps)	DMD50 / DMD2050 HW2 + HW7	DMD2050E / DMD2050EU HW2 + HW7 + HW24
									LDPC Feature
	HP-LDPC-OFF	2/3	6.3 – 13,078	LDPC Feature + HW19	—	LDPC Feature + HW20	6.3 – 13,078	LDPC Feature + HW19	DSSS Feature + LDPC Feature
	FACTOR x2		6.3 – 6,539	LDPC Feature + HW19	—	LDPC Feature + HW20	6.3 – 6,539	LDPC Feature + HW19	DSSS Feature + LDPC Feature
	FACTOR x4		6.3 – 3,270	LDPC Feature + HW19	—	LDPC Feature + HW20	6.3 – 3,269	LDPC Feature + HW19	DSSS Feature + LDPC Feature
	FACTOR x8		6.3 – 1,635	LDPC Feature + HW19	—	LDPC Feature + HW20	6.3 – 1,634	LDPC Feature + HW19	DSSS Feature + LDPC Feature
	FACTOR x16		6.3 0 817	LDPC Feature + HW19	—	LDPC Feature + HW20	6.3 0 817	LDPC Feature + HW19	DSSS Feature + LDPC Feature
	HP-LDPC-OFF	3/4	7.0 – 14,685	LDPC Feature + HW19	—	LDPC Feature + HW20	7.0 – 14,686	LDPC Feature + HW19	DSSS Feature + LDPC Feature
	FACTOR x2		7.0 – 7,342	LDPC Feature + HW19	—	LDPC Feature + HW20	7.0 – 7,342	LDPC Feature + HW19	DSSS Feature + LDPC Feature
	FACTOR x4		7.0 – 3,671	LDPC Feature + HW19	—	LDPC Feature + HW20	7.0 – 3,671	LDPC Feature + HW19	DSSS Feature + LDPC Feature
	FACTOR x8		7.0 – 1,836	LDPC Feature + HW19	—	LDPC Feature + HW20	7.0 – 1,835	LDPC Feature + HW19	DSSS Feature + LDPC Feature
	FACTOR x16		7.0 - 918	LDPC Feature + HW19	—	LDPC Feature + HW20	7.0 - 917	LDPC Feature + HW19	DSSS Feature + LDPC Feature
OQPSK	HP-LDPC-OFF	1/2	4.8 – 10,000	LDPC Feature + HW19	—	LDPC Feature + HW20	4.8 – 10,000	LDPC Feature + HW19	DSSS Feature + LDPC Feature
	FACTOR x2		4.8 – 5,000	LDPC Feature + HW19	—	LDPC Feature + HW20	4.8 – 5,000	LDPC Feature + HW19	DSSS Feature + LDPC Feature

Modulation	Code	Rate	Data Rate Range (kbps)	DMD20 / DMD20 LBST HW1 + HW6	DMD1050 / DMD1050T / DMD1050TS HW3 + HW8	OM20 HW1 + HW6	Data Rate Range (kbps)	DMD50 / DMD2050 HW2 + HW7	DMD2050E / DMD2050EU HW2 + HW7 + HW24
	FACTOR x4		4.8 – 2,500	LDPC Feature + HW19	—	LDPC Feature + HW20	4.8 – 2,500	LDPC Feature + HW19	DSSS Feature + LDPC Feature
	FACTOR x8		4.8 – 1,250	LDPC Feature + HW19	—	LDPC Feature + HW20	4.8 – 1,250	LDPC Feature + HW19	DSSS Feature + LDPC Feature
	FACTOR x16		4.8 – 625	LDPC Feature + HW19	—	LDPC Feature + HW20	4.8 – 625	LDPC Feature + HW19	DSSS Feature + LDPC Feature
	HP-LDPC-OFF	1/2	4.7 – 9,866	LDPC Feature + HW19	—	LDPC Feature + HW20	4.7 – 9,866	LDPC Feature + HW19	DSSS Feature + LDPC Feature
	FACTOR x2		4.7 – 4,933	LDPC Feature + HW19	—	LDPC Feature + HW20	4.7 – 4,933	LDPC Feature + HW19	DSSS Feature + LDPC Feature
	FACTOR x4		4.7 – 2,467	LDPC Feature + HW19	—	LDPC Feature + HW20	4.7 – 2,466	LDPC Feature + HW19	DSSS Feature + LDPC Feature
	FACTOR x8		4.7 – 1,233	LDPC Feature + HW19	—	LDPC Feature + HW20	4.7 – 1,233	LDPC Feature + HW19	DSSS Feature + LDPC Feature
	FACTOR x16		4.7 – 617	LDPC Feature + HW19	—	LDPC Feature + HW20	4.7 – 616	LDPC Feature + HW19	DSSS Feature + LDPC Feature
	HP-LDPC-OFF	2/3	6.3 – 13,078	LDPC Feature + HW19	—	LDPC Feature + HW20	6.3 – 13,078	LDPC Feature + HW19	DSSS Feature + LDPC Feature
	FACTOR x2		6.3 – 6,539	LDPC Feature + HW19	—	LDPC Feature + HW20	6.3 – 6,539	LDPC Feature + HW19	DSSS Feature + LDPC Feature
	FACTOR x4		6.3 – 3,270	LDPC Feature + HW19	—	LDPC Feature + HW20	6.3 – 3,269	LDPC Feature + HW19	DSSS Feature + LDPC Feature
	FACTOR x8		6.3 – 1,635	LDPC Feature + HW19	—	LDPC Feature + HW20	6.3 – 1,634	LDPC Feature + HW19	DSSS Feature + LDPC Feature
	FACTOR x16		6.3 – 817	LDPC Feature + HW19	—	LDPC Feature + HW20	6.3 – 817	LDPC Feature + HW19	DSSS Feature +

Modulation	Code	Rate	Data Rate Range (kbps)	DMD20 / DMD20 LBST HW1 + HW6	DMD1050 / DMD1050T / DMD1050TS HW3 + HW8	OM20 HW1 + HW6	Data Rate Range (kbps)	DMD50 / DMD2050 HW2 + HW7	DMD2050E / DMD2050EU HW2 + HW7 + HW24
									LDPC Feature
	HP-LDPC-OFF	3/4	7.0 – 14,685	LDPC Feature + HW19	—	LDPC Feature + HW20	7.0 – 14,686	LDPC Feature + HW19	DSSS Feature + LDPC Feature
	FACTOR x2		7.0 – 7,342	LDPC Feature + HW19	—	LDPC Feature + HW20	7.0 – 7,342	LDPC Feature + HW19	DSSS Feature + LDPC Feature
	FACTOR x4		7.0 – 3,671	LDPC Feature + HW19	—	LDPC Feature + HW20	7.0 – 3,671	LDPC Feature + HW19	DSSS Feature + LDPC Feature
	FACTOR x8		7.0 – 1,836	LDPC Feature + HW19	—	LDPC Feature + HW20	7.0 – 1,835	LDPC Feature + HW19	DSSS Feature + LDPC Feature
	FACTOR x16		7.0 - 918	LDPC Feature + HW19	—	LDPC Feature + HW20	7.0 - 917	LDPC Feature + HW19	DSSS Feature + LDPC Feature
Satellite Framing									
ALL	IDR 96K	—	T1/E1 / T2/E2	IDR Feature, Framing Only + HW9 for IESS	IDR Feature for Framing	IDR Feature, Framing Only + HW9 for IESS	T1/E1 / T2/E2 / T3/E3	IDR Feature, Framing Only + HW9 for IESS	IDR Feature for Framing
	IBS 1/15	—	N x 64, 64 – 1536, 2048	IBS Feature + HW9 for IESS	IBS Feature (Framing Only)	IBS Feature (Framing Only)	N x 64, 64 – 1536, 2048	IBS Feature	IBS Feature
	EF AUPC	—	Less than 20,000	AUPC Feature	AUPC Feature	AUPC Feature	Less than 20,000	AUPC Feature	Standard
	EDMAC	—	—	EDMAC Feature Framing Only	EDMAC Feature Framing Only	EDMAC Feature Framing Only	—	EDMAC Feature Framing Only	EDMAC Feature Framing Only
	SCC	—	—	Enhanced Async Feature	Enhanced Async Feature (Framing Only)	Enhanced Async Feature	—	Enhanced Async Feature	Enhanced Async Feature
	EFFICIENT D&I	—	N x 64, 64 – 1536, 2048	Drop and Insert Feature	Drop and Insert Feature (Framing Only)	Drop and Insert Feature	N x 64, 64 – 1536, 2048	IDR Feature, Framing Only + HW9 for IESS	Drop and Insert Feature (Framing Only)
	EBEM	—	—	—	EBEM Feature + HW5	—	—	—	—
Ethernet HDLC Framing									

Modulation	Code	Rate	Data Rate Range (kbps)	DMD20 / DMD20 LBST HW1 + HW6	DMD1050 / DMD1050T / DMD1050TS HW3 + HW8	OM20 HW1 + HW6	Data Rate Range (kbps)	DMD50 / DMD2050 HW2 + HW7	DMD2050E / DMD2050EU HW2 + HW7 + HW24
ALL	RADYNE	—	—	Standard + HW22	Standard (10/100)	Standard (10/100)	—	Standard + HW22	Standard (10/100/1000)
	COMTECH	—	—	Standard + HW22	Standard (10/100)	—	—	Standard + HW22	Standard (10/100/1000)
	MANAGED 570	—	—	Standard + HW22	Standard (10/100)	—	—	Standard + HW22	Standard (10/100/1000)
TRANSEC (HW28) Counter Mode (Interoperable with MD-1366)									
BPSK	Turbo	1/2	64 – 5,000	—	EBEM Feature + HW28	—	64 – 15,000	EBEM Feature + HW28	Standard
		2/3	64 – 6,667	—	EBEM Feature + HW28	—	64 – 20,000	EBEM Feature + HW28	Standard
		3/4	64 – 7,500	—	EBEM Feature + HW28	—	64 – 22,500	EBEM Feature + HW28	Standard
		7/8	64 – 8,750	—	EBEM Feature + HW28	—	64 – 26,250	EBEM Feature + HW28	Standard
		19/20	64 – 9,500	—	EBEM Feature + HW28	—	64 – 28,500	EBEM Feature + HW28	Standard
QPSK	Turbo	1/2	64 – 10,000	—	EBEM Feature + HW28	—	64 – 30,000	EBEM Feature + HW28	Standard
		2/3	64 – 13,333	—	EBEM Feature + HW28	—	64 – 40,000	EBEM Feature + HW28	Standard
		3/4	64 – 15,000	—	EBEM Feature + HW28	—	64 – 45,000	EBEM Feature + HW28	Standard
		7/8	64 – 17,500	—	EBEM Feature + HW28	—	64 – 52,500	EBEM Feature + HW28	Standard
		19/20	64 – 19,000	—	EBEM Feature + HW28	—	64 – 57,000	EBEM Feature + HW28	Standard
8PSK	Turbo	1/2	256 – 15,000	—	EBEM Feature + HW28	—	256 – 45,000	EBEM Feature + HW28	Standard
		2/3	256 – 20,000	—	EBEM Feature + HW28	—	256 – 60,000	EBEM Feature + HW28	Standard
		3/4	256 – 20,000	—	EBEM Feature + HW28	—	256 – 67,500	EBEM Feature + HW28	Standard
		7/8	256 – 20,000	—	EBEM Feature + HW28	—	256 – 78,750	EBEM Feature + HW28	Standard
		19/20	256 – 20,000	—	EBEM Feature + HW28	—	256 – 85,500	EBEM Feature + HW28	Standard
16APSK	Turbo	1/2	256 – 20,000	—	EBEM Feature + HW28	—	256 – 60,000	EBEM Feature + HW28	Standard
		2/3	256 – 20,000	—	EBEM Feature + HW28	—	256 – 80,000	EBEM Feature + HW28	Standard
		3/4	256 – 20,000	—	EBEM Feature + HW28	—	256 – 90,000	EBEM Feature + HW28	Standard
		7/8	256 – 20,000	—	EBEM Feature + HW28	—	256 – 105,000	EBEM Feature + HW28	Standard
		19/20	256 – 20,000	—	EBEM Feature + HW28	—	256 – 114,000	EBEM Feature + HW28	Standard

Modulation	Code	Rate	Data Rate Range (kbps)	DMD20 / DMD20 LBST HW1 + HW6	DMD1050 / DMD1050T / DMD1050TS HW3 + HW8	OM20 HW1 + HW6	Data Rate Range (kbps)	DMD50 / DMD2050 HW2 + HW7	DMD2050E / DMD2050EU HW2 + HW7 + HW24
TRANSEC (HW28) Block Mode Mode (Interoperable with SLM-5650A) HW-27 Frame Expansion: (3 + 16 * N) / (16 * N), N = 1...16									
BPSK	TPC	5/16	1.5 – 2,632	TPC Feature + HW27	TPC Feature + HW27	—	1.5 – 7,895	TPC Feature + HW27	Standard
		21/44	2.3 – 4,019	TPC Feature + HW27	TPC Feature + HW27	TPC Feature + HW27	2.3 – 12,057	TPC Feature + HW27	Standard
QPSK	TPC	21/44	4.6 – 8,038	TPC Feature + HW27	TPC Feature + HW27	TPC Feature + HW27	4.6 – 20,000	TPC Feature + HW27	Standard
		3/4	7.2 – 12,632	TPC Feature + HW27	TPC Feature + HW27	TPC Feature + HW27	7.2 – 20,000	TPC Feature + HW27	Standard
QPSK	TPC	7/8	8.4 – 14,737	TPC Feature + HW27	TPC Feature + HW27	TPC Feature + HW27	8.4 – 20,000	TPC Feature + HW27	Standard
		21/44	4.6 – 8,038	TPC Feature + HW27	TPC Feature + HW27	TPC Feature + HW27	4.6 – 20,000	TPC Feature + HW27	Standard
OQPSK	TPC	3/4	7.2 – 12,632	TPC Feature + HW27	TPC Feature + HW27	TPC Feature + HW27	7.2 – 20,000	TPC Feature + HW27	Standard
		7/8	8.4 – 14,737	TPC Feature + HW27	TPC Feature + HW27	TPC Feature + HW27	8.4 – 20,000	TPC Feature + HW27	Standard
8PSK	TPC	3/4	10.8 – 18,947	8PSK + TPC Feature + HW27	8PSK + TPC Feature + HW27	8PSK + TPC Feature + HW27	10.8 – 20,000	8PSK + TPC Feature + HW27	Standard
		7/8	12.6 – 20,000	8PSK + TPC Feature + HW27	8PSK + TPC Feature + HW27	8PSK + TPC Feature + HW27	12.6 – 20,000	8PSK + TPC Feature + HW27	Standard
8QAM	TPC	3/4	10.8 – 18,974	8PSK + TPC Feature + HW27	8PSK + TPC Feature + HW27	8PSK + TPC Feature + HW27	10.8 – 20,000	8PSK + TPC Feature + HW27	Standard
		7/8	12.6 – 20,000	8PSK + TPC Feature + HW27	8PSK + TPC Feature + HW27	8PSK + TPC Feature + HW27	12.6 – 20,000	8PSK + TPC Feature + HW27	Standard
16QAM	TPC	3/4	14.4 – 20,000	16QAM + TPC Feature + HW27	16QAM + TPC Feature + HW27	16QAM + TPC Feature + HW27	14.4 – 20,000	16QAM + TPC Feature + HW27	Standard
		7/8	16.8 – 20,000	16QAM + TPC Feature + HW27	16QAM + TPC Feature + HW27	16QAM + TPC Feature + HW27	16.8 – 20,000	16QAM + TPC Feature + HW27	Standard
BPSK	HP-LDPC	1/2	2.4 – 4,211	LDPC Feature + HW27	LDPC Feature + HW27	LDPC Feature + HW27	2.4 – 12,632	LDPC Feature + HW27	LDPC Feature
	ULL-LDPC	1/2	2.4 – 4,154	LDPC Feature + HW27	—	LDPC Feature + HW27	2.4 – 12,463	LDPC Feature + HW27	LDPC Feature
QPSK	HP-LDPC	1/2	4.8 – 8,421	LDPC Feature + HW27	LDPC Feature + HW27	LDPC Feature + HW27	4.8 – 20,000	LDPC Feature + HW27	LDPC Feature
		2/3	6.4 – 11,228	LDPC Feature + HW27	LDPC Feature + HW27	LDPC Feature + HW27	6.4 – 20,000	LDPC Feature + HW27	LDPC Feature

Modulation	Code	Rate	Data Rate Range (kbps)	DMD20 / DMD20 LBST HW1 + HW6	DMD1050 / DMD1050T / DMD1050TS HW3 + HW8	OM20 HW1 + HW6	Data Rate Range (kbps)	DMD50 / DMD2050 HW2 + HW7	DMD2050E / DMD2050EU HW2 + HW7 + HW24
	ULL-LDPC	3/4	7.2 – 12,632	LDPC Feature + HW27	LDPC Feature + HW27	LDPC Feature + HW27	7.2 – 20,000	LDPC Feature + HW27	LDPC Feature
		1/2	4.7 – 8,308	LDPC Feature + HW27	—	LDPC Feature + HW27	4.7 – 20,000	LDPC Feature + HW27	LDPC Feature
		2/3	6.3 – 11,013	LDPC Feature + HW27	—	LDPC Feature + HW27	6.3 – 20,000	LDPC Feature + HW27	LDPC Feature
		3/4	7.0 – 12,366	LDPC Feature + HW27	—	LDPC Feature + HW27	7.0 – 20,000	LDPC Feature + HW27	LDPC Feature
OQPSK	HP-LDPC	1/2	4.8 – 8,421	LDPC Feature + HW27	LDPC Feature + HW27	LDPC Feature + HW27	4.8 – 20,000	LDPC Feature + HW27	LDPC Feature
		2/3	6.4 – 11,228	LDPC Feature + HW27	LDPC Feature + HW27	LDPC Feature + HW27	6.4 – 20,000	LDPC Feature + HW27	LDPC Feature
		3/4	7.2 – 12,632	LDPC Feature + HW27	LDPC Feature + HW27	LDPC Feature + HW27	7.2 – 20,000	LDPC Feature + HW27	LDPC Feature
	ULL-LDPC	1/2	4.7 – 8,308	LDPC Feature + HW27	—	LDPC Feature + HW27	4.7 – 20,000	LDPC Feature + HW27	LDPC Feature
		2/3	6.3 – 11,013	LDPC Feature + HW27	—	LDPC Feature + HW27	6.3 – 20,000	LDPC Feature + HW27	LDPC Feature
		3/4	7.0 – 12,366	LDPC Feature + HW27	—	LDPC Feature + HW27	7.0 – 20,000	LDPC Feature + HW27	LDPC Feature
8PSK	HP-LDPC	2/3	9.6 – 16,842	8PSK + LDPC Feature + HW27	8PSK + LDPC Feature + HW27	8PSK + LDPC Feature + HW27	9.6 – 20,000	8PSK + LDPC Feature + HW27	LDPC Feature
		3/4	10.8 – 18,947	8PSK + LDPC Feature + HW27	8PSK + LDPC Feature + HW27	8PSK + LDPC Feature + HW27	10.8 – 20,000	8PSK + LDPC Feature + HW27	LDPC Feature
8QAM	HP-LDPC	2/3	9.6 – 16,842	8QAM + LDPC Feature + HW27	8QAM + LDPC Feature + HW27	8QAM + LDPC Feature + HW27	9.6 – 20,000	8QAM + LDPC Feature + HW27	LDPC Feature
		3/4	10.8 – 18,947	8QAM + LDPC Feature + HW27	8QAM + LDPC Feature + HW27	8QAM + LDPC Feature + HW27	10.8 – 20,000	8QAM + LDPC Feature + HW27	LDPC Feature
16QAM	HP-LDPC	3/4	14.4 – 20,000	16QAM + LDPC Feature + HW27	16QAM + LDPC Feature + HW27	16QAM + LDPC Feature + HW27	14.4 – 20,000	16QAM + LDPC Feature + HW27	LDPC Feature



DMD20/DMD20LBST

Universal Satellite Modem Installation and Operation Manual

Part Number MN-DMD20-20LBST
Revision 14

BLANK PAGE

Table of Contents

CHAPTER 1.	INTRODUCTION.....	1-1
1.1	Overview	1-1
1.2	Configurations	1-2
1.2.1	Features/Options Installed at Time of Order.....	1-2
1.2.2	Feature Upgrades	1-2
1.2.3	Hardware Options	1-2
1.2.4	Factory Installed Options.....	1-3
1.3	Function Accessibility	1-3
CHAPTER 2.	INSTALLATION	2-1
2.1	Unpacking and Inspection	2-1
2.2	Installation Requirements.....	2-2
2.3	Removal and Assembly	2-3
2.4	Mounting Considerations	2-3
2.5	Initial Configuration Check.....	2-4
2.6	Modulator Checkout.....	2-6
2.6.1	Initial Power-Up.....	2-6
2.6.2	Factory Terminal Setup	2-6
CHAPTER 3.	THEORY OF OPERATION	3-1
3.1	Modem Hardware.....	3-1
3.1.1	L-Band/IF Printed Circuit Card	3-2
3.1.2	Baseband Processing Printed Circuit Card	3-3
3.1.3	Enhanced Interface Printed Circuit Card.....	3-3
3.2	Functional Block Diagram.....	3-3
3.2.1	Front Panel.....	3-4
3.2.2	Baseband Processing	3-4
3.2.3	Tx Baseband Processing.....	3-5
3.2.4	Rx Baseband Processing.....	3-5
3.3	Monitor & Control (M&C) Subsystem	3-5
3.3.1	Terminal Port	3-6
3.3.2	Modem Remote Communications (RLLP).....	3-6
3.3.3	Ethernet M&C Port	3-6

3.3.4	Modem Monitor Status.....	3-7
3.4	Async Port / ES-ES Communications.....	3-7
3.5	Internal Clock	3-7
3.6	Loopback Features (Terrestrial & IF)	3-8
3.7	Clocking Options	3-11
3.7.1	TX Clock Options	3-11
3.7.1.1	SCTE: Serial Clock Transmit External.....	3-12
3.7.1.2	SCT: Serial Clock Transmit.....	3-12
3.7.2	RX Buffer Clock Options	3-12
3.7.2.1	RX SAT Clock	3-13
3.7.2.2	CTE: Serial Clock Transmit External.....	3-13
3.7.2.3	SCT: Serial Clock Transmit.....	3-13
3.7.2.4	EXT CLK/EXT BNC: External Clock, J16.....	3-13
3.7.2.5	EXT IDI: Insert Data In.....	3-13
3.7.3	EXT REF: External Reference, Top BNC Port, J10	3-14
3.8	RS530/422/V.35 Interface (Standard)	3-14
3.8.1	G.703 Interface (Optional).....	3-14
3.8.2	HSSI Interface (Optional).....	3-14
3.8.3	Ethernet Data Interface (Optional).....	3-14
3.9	Reed-Solomon Codec	3-15
3.9.1	Reed-Solomon Operation	3-15
3.9.2	Reed-Solomon Code Rate.....	3-15
3.9.3	Interleaving.....	3-16
3.10	Asynchronous Overhead Operation (Framing/Multiplexer Capability).....	3-17
3.11	Standard IBS Mode	3-18
3.12	Asynchronous Multiplexer Mode	3-19
3.13	ESC Backward Alarms	3-19
3.13.1	To Disable the ESC Backward Alarms	3-19
3.14	Satellite Control Channel (SCC)	3-19
3.14.1	SCC Framing Structure	3-20
3.14.2	Aggregate Data Rate	3-21
3.14.3	Overhead Rate Comparison	3-21
3.14.4	Actual Overhead Rate Calculation.....	3-22
3.14.5	SCC Overhead Channel Setup	3-23
3.15	DoubleTalk Carrier-in-Carrier Option.....	3-25
3.15.1	What is DoubleTalk Carrier-in-Carrier?.....	3-25
3.15.2	Application Requirements	3-25
3.15.3	Operational Recommendations	3-28

3.15.4	System Functionality and Operational Considerations.....	3-29
3.15.5	DoubleTalk Carrier-in-Carrier Cancellation Process	3-31
3.15.6	Margin Requirements	3-33
3.15.7	Carrier-in-Carrier Latency	3-33
3.15.8	Carrier-in-Carrier Link Design	3-33
3.15.8.1	Symmetric Data Rate Link.....	3-34
3.15.8.2	Asymmetric Data Rate Link	3-37
3.15.8.3	Power Limited Links	3-38
3.15.9	Carrier-in-Carrier Commissioning and Deployment.....	3-39
3.15.10	Validating Carrier-in-Carrier Performance	3-40
3.15.11	Operational References.....	3-41
3.15.12	Carrier-in-Carrier Link Budget Calculation.....	3-41
3.15.13	Estimating PSD Ratio.....	3-42
3.15.13.1	Estimating PSD Ratio from LST.....	3-42
3.15.13.2	Estimating PSD Ratio from Satmaster	3-43
3.15.13.3	Estimating PSD Ratio Using Spectrum Analyzer	3-43
3.15.14	DoubleTalk Carrier-in-Carrier Specifications.....	3-44
3.15.15	Carrier-in-Carrier Summary.....	3-44
3.15.16	Glossary.....	3-44
3.16	EDMAC Satellite Framing/Deframing Mode	3-46
3.17	Locating the ID Code Operational Procedure	3-46
3.18	Strap Codes	3-46
CHAPTER 4.	USER INTERFACES.....	4-1
4.1	User Interfaces	4-1
4.2	Front Panel User Interface	4-1
4.2.1	LCD Front Panel Display	4-3
4.2.2	Cursor Control Arrow Keys.....	4-3
4.2.3	Numeric Keypad	4-3
4.2.4	Front Panel LED Indicators	4-4
4.3	Parameter Setup	4-4
4.4	Front Panel Control Screen Menus	4-5
4.4.1	Main Menu	4-5
4.4.2	Modulator Menu Options and Parameters	4-6
4.4.3	Demodulator Menu Options and Parameters	4-15
4.4.4	Interface Menu Options and Parameters.....	4-20
4.4.5	Monitor Menu Options and Parameters.....	4-25
4.4.6	Alarms Menu Options and Parameters.....	4-28
4.4.7	System Menu Options and Parameters	4-36
4.4.8	Test Menu Options and Parameters.....	4-45
4.5	Terminal Mode Control.....	4-47
4.5.1	Modem Terminal Mode Control	4-47

4.5.2	Modem Setup for Terminal Mode.....	4-47
4.6	Terminal Port User Interface	4-48
4.7	Connecting the Terminal	4-48
4.8	Terminal Screens	4-48
CHAPTER 5.	REAR PANEL INTERFACES	5-1
5.1	DMD20/DMD20 LBST Connections	5-1
5.2	Compact Flash	5-4
5.3	Power Input Modules.....	5-4
5.3.1	AC Power Input Module.....	5-4
5.4	DMD20 Chassis Connections (Standard).....	5-4
5.4.1	EXT REF (J10)	5-4
5.4.2	TX IF (J11)	5-4
5.4.3	TX L-Band IF (J12).....	5-4
5.4.4	RX IF.....	5-5
5.4.5	RX L-Band IF	5-5
5.4.6	ALARM (J15).....	5-5
5.4.7	EXT CLK (J16).....	5-6
5.4.8	ASYNC (J17).....	5-6
5.4.9	J18	5-6
5.4.10	EIA-530 (J19)	5-7
5.4.11	REMOTE (J20).....	5-8
5.4.12	ETHERNET (J21).....	5-8
5.5	DMD20 LBST Chassis Connections (Standard)	5-9
5.5.1	EXT REF (J10)	5-9
5.5.2	TX (J11).....	5-9
5.5.3	RX (J14)	5-9
5.5.4	ALARM (J15).....	5-9
5.5.5	EXT CLK (J16).....	5-10
5.5.6	ASYNC (J17).....	5-10
5.5.7	(J18).....	5-10
5.5.8	EIA-530 (J19)	5-11
5.5.9	REMOTE (J20).....	5-12
5.5.10	ETHERNET (J21).....	5-12
5.6	DMD20/DMD20 LBST Optional Data Interfaces.....	5-12
5.7	IDR/IBS Interface (Optional)	5-12
5.8	G.703 IDR/IBS Interface (Optional)	5-13
5.8.1	ESC ALARM (J1).....	5-13
5.8.2	64K AUDIO (J2).....	5-14

5.8.3	8K DATA (J3)	5-15
5.8.4	G.703 BAL (J4).....	5-16
5.8.5	SWITCH INTERFACE (J5).....	5-17
5.8.6	SD (DDI) (J6)	5-20
5.8.7	DDO (J7)	5-20
5.8.8	IDI (J8)	5-20
5.8.9	SD (IDO) (J9)	5-20
5.9	Ethernet Data Interface (Optional)	5-20
5.10	High-Speed Serial Interface (HSSI) (Optional).....	5-21
5.10.1	HSSI (J6)	5-21
5.11	ASI/DVB/M2P Interface (Optional).....	5-21
5.11.1	ASI IN (J1)	5-21
5.11.2	ASI OUT (J2).....	5-21
5.11.3	DVB/M2P IN (J3).....	5-22
5.11.4	DVB/M2P OUT (J4).....	5-24
5.12	Ethernet Data Interface (Optional)	5-26
5.13	HSSI / G.703.....	5-26
5.13.1	64K AUDIO (J2).....	5-27
5.13.2	8K DATA (J3)	5-28
5.13.3	G.703 BAL (J4).....	5-28
5.13.4	ESC ALARM (J5).....	5-29
5.13.5	SD (DDI) (J6)	5-29
5.13.6	DDO (J7)	5-29
5.13.7	IDI (J8)	5-29
5.13.8	SD (IDO) (J9)	5-30
5.14	HSSI / Ethernet (J1).....	5-30
5.15	Ethernet Data Interface	5-31
5.16	GigE Interface.....	5-32
CHAPTER 6.	MAINTENANCE AND TROUBLESHOOTING	6-1
6.1	Periodic Maintenance	6-1
6.1.1	Clock Adjustment.....	6-1
6.2	Troubleshooting	6-1
6.2.1	Alarm Faults	6-2
6.2.1.1	Major Tx Alarms.....	6-2
6.2.1.2	Major Rx Alarms.....	6-3
6.2.1.3	Minor Tx Alarms.....	6-3
6.2.1.4	Minor Rx Alarms	6-4
6.2.1.5	Drop and Insert Alarms	6-5
6.2.1.6	Common Major Alarms.....	6-5

6.2.2	Alarm Masks.....	6-6
6.2.2.1	Active Alarms	6-6
6.2.2.1.1	Major Alarms	6-6
6.2.2.1.2	Minor Alarms	6-6
6.2.2.1.3	Common Equipment Faults.....	6-6
6.2.2.2	Latched Alarms	6-7
6.2.2.3	Backward Alarms	6-7
6.3	IBS Fault Conditions and Actions	6-7
CHAPTER 7.	TECHNICAL SPECIFICATIONS	7-1
7.1	Data Rates	7-1
7.2	Modulator	7-1
7.3	Demodulator	7-2
7.4	Plesiochronous Buffer	7-3
7.5	Monitor and Control.....	7-3
7.6	DMD20/DMD20 LBST Drop and Insert (Optional)	7-3
7.7	Terrestrial Interfaces	7-3
7.8	IDR/ESC Interface (Optional).....	7-3
7.9	IBS/Synchronous Interface (Standard)	7-3
7.10	High-Speed Serial Interface (HSSI)	7-4
7.11	ASI.....	7-4
7.12	DVB/M2P	7-4
7.13	Ethernet Data Interface (Optional)	7-4
7.14	Gigi Ethernet Data Interface (Optional)	7-4
7.15	HSSI / G703.....	7-4
7.16	HSSI /ETHERNET	7-4
7.17	Environmental	7-5
7.18	Physical	7-5
7.19	DMD20/DMD20 LBST Data Rate Limits	7-5
7.19.1	Non-DVB.....	7-5

7.19.2	DVB	7-7
7.20	BER Specifications.....	7-9
7.20.1	BER Performance (Viterbi)	7-9
7.20.2	BER Performance (Sequential).....	7-10
7.20.3	BER Performance (Viterbi with Reed-Solomon).....	7-11
7.20.4	BER Performance ((O)QPSK Turbo).....	7-12
7.20.5	BER Performance (B/O/QPSK Turbo).....	7-13
7.20.6	BER Performance (8PSK Turbo).....	7-14
7.20.7	BER Performance (8PSK Trellis)	7-15
7.20.8	BER Performance (8PSK Turbo).....	7-16
7.20.9	BER Performance (16QAM Viterbi).....	7-17
7.20.10	BER Performance (16QAM Viterbi with Reed-Solomon)	7-18
7.20.11	BER Performance (16QAM Turbo)	7-19
7.20.12	BER Performance (16QAM Turbo)	7-20
7.20.13	1/2 Rate B/O/QPSK BER Performance (LDPC).....	7-21
7.20.14	2/3 Rate Q/8PSK/8QAM BER Performance (LDPC)	7-22
7.20.15	3/4 Rate Q/8PSK, 8/16QAM BER Performance (LDPC)	7-23
7.20.16	AGC Output Voltage.....	7-28
APPENDIX A.	PRODUCT OPTIONS.....	A-1
A.1	Hardware Options	A-1
A.2	G.703/IDR ESC Interface	A-1
A.3	Internal High Stability	A-1
A.4	DC Input Prime Power	A-1
A.5	ASI/RS-422 Parallel	A-1
A.6	ASI/LVDS Parallel.....	A-1
A.7	HSSI	A-1
A.8	Ethernet Data Interface	A-1
A.9	Gigi Ethernet Data Interface	A-2
A.10	HSSI / G.703.....	A-2
A.11	HSSI / ETHERNET	A-2
A.12	Turbo Product Code / Variable Reed-Solomon	A-2
A.13	Combination Low-density Parity Check (LDPC) and TPC Codec	A-2
A.14	Customized Options.....	A-2

APPENDIX B.	FRONT PANEL UPGRADE PROCEDURE.....	B-1
B.1	Introduction	B-1
B.2	Required Equipment.....	B-1
B.3	Upgrade Procedure.....	B-1
B.4	Demonstration Procedure.....	B-3
B.4.1	Running in Demonstration Mode.....	B-5
B.4.2	Canceling Demonstration Mode	B-6
APPENDIX C.	CARRIER CONTROL	C-1
C.1	States	C-1
C.2	Carrier Off.....	C-1
C.3	Carrier On	C-1
C.4	Carrier Auto.....	C-1
C.5	Carrier VSat.....	C-2
C.6	Carrier RTS	C-2
APPENDIX D.	STRAP CODES	D-1
D.1	Strap Codes	D-1
D.2	Sample Applications	D-5
D.2.1	Operational Case Examples	D-6
APPENDIX E.	TCP/IP ETHERNET SETUP.....	E-1
E.1	Introduction	E-1
E.2	TCP/IP Network Configuration	E-1
E.3	Network Configuration Summary.....	E-3
E.4	Ethernet Test.....	E-3
E.4.1	Connecting the Modem Ethernet Cable to a Network Link.....	E-3
E.4.2	Connecting the Modem Ethernet Cable Directly to a Computer (without a Network)	E-3
E.4.3	Testing the Ethernet connection using the Ping Program (Optional)	E-6
APPENDIX F.	WEB INTERFACE SETUP GUIDE.....	F-1
F.1	Introduction	F-1

F.2	Setup.....	F-1
F.2.1	TCP-IP Menus	F-1
F.2.2	IP Address.....	F-2
F.3	Web Interface Security	F-2
F.3.1	Default User Accounts	F-2
F.3.2	User Account Data	F-3
F.1	User Account Setup.....	F-3
F.1.1	Edit the User ID.	F-4
F.1.2	Edit the Access Group.	F-4
F.1.3	Edit the Authentication Password.	F-4
F.2	Reset a User Account	F-5
F.3	Confirmation.....	F-5
F.4	Equipment Website.....	F-6
F.4.1	Log in to the Equipment Website.....	F-7
F.5	Web Page Appearance	F-8
F.6	Configure Web Browsers for the Radyne WEB Interface.....	F-9
F.6.1	Configure Internet Explorer 9 for the Radyne WEB Interface	F-9
F.6.2	Configure Firefox for the Radyne WEB Interface	F-9
F.6.2.1	Change the encoding:	F-10
F.6.2.2	Install the Internet Explorer Tab V2 add-on	F-11
F.6.3	Configure Chrome for the Radyne WEB Browser.....	F-12
F.6.3.1	Change the encoding	F-13
F.6.3.2	Install the Internet Explorer Tab for Chrome.....	F-14
F.6.4	Configure Safari for the Radyne WEB Browser.....	F-15
F.6.4.1	Empty the browser cache.....	F-15
F.6.4.2	Reset the Ethernet M&C port.....	F-16
F.6.4.3	Re-enter the Modem IP address	F-16
F.6.4.4	Change the encoding	F-18
F.6.5	Configure Maxthon for the Radyne WEB Browser	F-19
F.6.5.1	Change the browser mode.....	F-20
F.6.5.2	Change the encoding	F-21
APPENDIX G.	AUPC OPERATION	G-1
G.1	Automatic Uplink Power Control (AUPC Operation).....	G-1
G.1.1	Radyne AUPC.....	G-1
G.1.2	EF AUPC.....	G-2
G.1.3	Near Side AUPC	G-2
APPENDIX H.	DROP AND INSERT (D&I).....	H-1
H.1	Drop and Insert (D&I).....	H-1
H.1.1	Drop Only	H-3

H.1.2	Insert Only	H-3
H.1.3	Mode Selection	H-4
H.1.3.1	PCM-30	H-4
H.1.3.2	PCM-30C	H-4
H.1.3.3	PCM-31	H-4
H.1.3.4	PCM-31C	H-4
H.1.3.5	T1-D4/T1-D4-S	H-5
H.1.3.6	T1-ESF/T1-ESF-S	H-5
H.1.4	Multidestinational Systems	H-5
H.1.5	Drop and Insert Mapping	H-6
H.2	Configuring the Modem for Drop and Insert	H-8
H.2.1	Data Rate	H-8
H.2.2	Operational Network Specification	H-9
H.2.3	Terrestrial Framing - Drop Mode/Insert Mode	H-9
H.2.3.1	Insert Terrestrial Frame Source	H-9
H.2.4	D&I Sample Configurations and D&I Clock Setup Options	H-10
H.3	D&I Maps and Map Editing	H-13
APPENDIX I.	EFFICIENT DROP AND INSERT (D&I)	I-1
I.1	Introduction	I-1
I.2	Prerequisite	I-1
I.3	Efficient Drop & Insert Mode	I-2
I.3.1	Calculating the Required Satellite Bandwidth	I-3
I.3.2	Calculating the Basic Efficient D&I Rate	I-3
I.3.3	Calculating the Efficient D&I Rate with E1 Signaling	I-3
I.3.4	Calculating the Efficient D&I Rate with Enhanced Asynchronous Overhead	I-3
I.3.4.1	Summary and Examples:	I-4
APPENDIX J.	ETHERNET DATA INTERFACE SETUP	J-1
J.1	Configure the modem to use the Ethernet Data Interface (Optional)	J-1
J.1.1	Ethernet Flow Control	J-1
J.1.1.1	Half-Duplex Flow Control	J-2
J.1.1.2	Full-Duplex Flow Control	J-2
J.1.2	Ethernet Daisy Chain	J-2
J.1.3	Ethernet QOS Type	J-2
J.1.4	Ethernet QOS Queue	J-2
J.1.5	Set up the Ethernet Bridge to operate like a FIFO	J-3
J.1.6	Packet Statistics	J-4

PREFACE

About this Manual

This manual describes the installation and operation of the DMD20/DMD20LBST Universal Satellite Modem.

Conventions and References

Patents and Trademarks

See all of Comtech EF Data's Patents and Patents Pending at <http://patents.comtechefdata.com>.

Comtech EF Data acknowledges that all trademarks are the property of the trademark owners.

- DoubleTalk[®] is licensed from "Raytheon Applied Signal Technology".
- DoubleTalk[®] is a registered trademark of "Raytheon Applied Signal Technology".
- Carrier-in-Carrier[®] is a registered trademark of Comtech EF Data.

Related Documents

The following documents are referenced in this manual:

- Department of Defense (DOD) MIL-STD-188-114A, *Electrical Characteristics of Digital Interface Circuits*
- Department of Defense (DOD) MIL-STD-188-165A, *Interoperability and Performance Standards for SHF Satellite Communications PSK Modems (FDMA Operation)* (dated November 2005)
- *INTELSAT Earth Station Standards IESS-308, -309, -310, and -315*
- *EUTELSAT SMS*

Military Standards

References to "MIL-STD-188" apply to the 114A series (i.e., MIL-STD-188-114A), which provides electrical and functional characteristics of the unbalanced and balanced voltage digital interface circuits applicable to both long haul and tactical communications. Specifically, these references apply to the MIL-STD-188-114A electrical characteristics for a balanced voltage digital interface circuit, Type 1 generator, for the full range of data rates. For more information, refer to the Department of Defense (DOD) MIL-STD-188-114A, *Electrical Characteristics of Digital Interface Circuits*.

Cautions and Warnings



IMPORTANT or **NOTE** indicates a statement associated with the task being performed or information critical for proper equipment function.



CAUTION indicates a hazardous situation that, if not avoided, may result in minor or moderate injury. **CAUTION** may also be used to indicate other unsafe practices or risks of property damage.



WARNING indicates a potentially hazardous situation that, if not avoided, could result in death or serious injury.

Safety Compliance

EN 60950

Applicable testing is routinely performed as a condition of manufacturing on all units to ensure compliance with safety requirements of EN60950. This equipment meets the Safety of Information Technology Equipment specification as defined in EN60950.



Low Voltage Directive (LVD)

The following information is applicable for the European Low Voltage Directive (EN60950):

<HAR>	Type of power cord required for use in the European Community.
	CAUTION: Double-pole/Neutral Fusing ACHTUNG: Zweipolige bzw. Neutralleiter-Sicherung

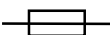
International Symbols:

Symbol	Definition
	Alternating Current
	Fuse

Symbol	Definition
	Protective Earth / Safety Ground
	Chassis Ground

Warranty Policy

Comtech EF Data products are warranted against defects in material and workmanship for a period of two years from the date of shipment. During the warranty period, Comtech EF Data will, at its option, repair or replace products that prove to be defective. Repairs are warranted for the remainder of the original two year warranty, or a 90 day extended warranty, whichever is longer.

For equipment under warranty, the owner is responsible for freight to Comtech EF Data and all related customs, taxes, tariffs, insurance, etc. Comtech EF Data is responsible for the freight charges only for return of the equipment from the factory to the owner. Comtech EF Data will return the equipment by the same method (i.e., Air, Express, Surface) as the equipment was sent to Comtech EF Data.

All equipment returned for warranty repair must have a valid RMA number issued prior to return and be marked clearly on the return packaging. Comtech EF Data strongly recommends all equipment be returned in its original packaging.

Comtech EF Data Corporation's obligations under this warranty are limited to repair or replacement of failed parts, and the return shipment to the buyer of the repaired or replaced parts.

Limitations of Warranty

The warranty does not apply to any part of a product that has been installed, altered, repaired, or misused in any way that, in the opinion of Comtech EF Data Corporation, would affect the reliability or detracts from the performance of any part of the product, or is damaged as the result of use in a way or with equipment that had not been previously approved by Comtech EF Data Corporation.

The warranty does not apply to any product or parts thereof where the serial number or the serial number of any of its parts has been altered, defaced, or removed.

The warranty does not cover damage or loss incurred in transportation of the product.

The warranty does not cover replacement or repair necessitated by loss or damage from any cause beyond the control of Comtech EF Data Corporation, such as lightning or other natural and weather related events or wartime environments.

The warranty does not cover any labor involved in the removal and or reinstallation of warranted equipment or parts on site, or any labor required to diagnose the necessity for repair or replacement.

The warranty excludes any responsibility by Comtech EF Data Corporation for incidental or consequential damages arising from the use of the equipment or products, or for any inability to use them either separate from or in combination with any other equipment or products.

A fixed charge established for each product will be imposed for all equipment returned for warranty repair where Comtech EF Data Corporation cannot identify the cause of the reported failure.

Exclusive Remedies

Comtech EF Data Corporation's warranty, as stated is in lieu of all other warranties, expressed, implied, or statutory, including those of merchantability and fitness for a particular purpose. The buyer shall pass on to any purchaser, lessee, or other user of Comtech EF Data Corporation's products, the aforementioned warranty, and shall indemnify and hold harmless Comtech EF Data Corporation from any claims or liability of such purchaser, lessee, or user based upon allegations that the buyer, its agents, or employees have made additional warranties or representations as to product preference or use.

The remedies provided herein are the buyer's sole and exclusive remedies. Comtech EF Data shall not be liable for any direct, indirect, special, incidental, or consequential damages, whether based on contract, tort, or any other legal theory.

Customer Support

Support Business Hours - Monday through Friday - 8:00 a.m. to 5:00 p.m. (MST)

Comtech EF Data & Radyne

- Satellite Modems
- Modem Accessories
- Amplifiers
- Converters
- Transceivers
- Terminals
- IP-Enabled Satellite Modems
- IP-Based Modem Accessories
- Encapsulators, Receivers, Filtering & Encryption
- *turboIP*® Performance Enhancement Proxies (PEP)
- SkyWire™ MDX420 Satellite Network Gateway
- Vipersat Network Products
- IP-Enabled Satellite Modems used in conjunction with VMS

Tel: +1.480.333.4357
Fax: +1.480.333.2500
Email: techsupport@comtechefdata.com

Tel: +1.480.333.2433
Fax: +1.480.333.2161
Email: cdmipsupport@comtechefdata.com

Tel: +1.510.252.1462 - select option #2
Fax: +1.510.252.1695
Email: supportcvni@comtechefdata.com

After Hours and Weekends:

Comtech

Tel: +1.480.333.4357

Radyne

Tel: +1.602.980.5220

Chapter 1. INTRODUCTION

This chapter provides an overview of the DMD20/DMD20 LBST Universal Satellite Modem. The DMD20 will be referred to in this manual as “the standard unit” and the DMD20 LBST will be referred to as the LBST. When describing the DMD20/DMD20 LBST, it may be referred to as “the DMD20”, “the modem”, or “the unit”.

1.1 Overview

The Radyne DMD20/DMD20 LBST Universal Satellite Modem (Figure 1-1 & Figure 1-2) offers the best features of a sophisticated programmable IBS/IDR and Closed Network Modem, at an affordable price

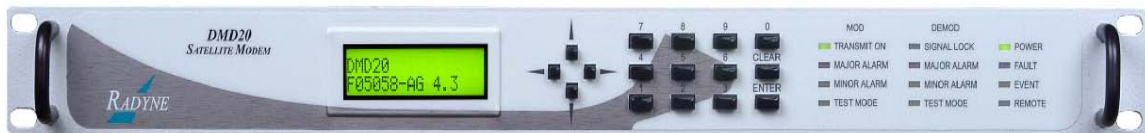

Figure 1-1 DMD20 Universal Satellite Modem Front Panel



Figure 1-2 DMD20 LBST Universal Satellite Modem Front Panel

This versatile equipment package combines unsurpassed performance with numerous user-friendly Front Panel Programmable Functions. The unit provides selectable functions for different services: Intelsat IDR and IBS, DVB, Low-density Parity Check Coding (LDPC) and Closed Networks are supported. All of the configuration and Monitor and Control (M&C) Functions are available at the Front Panel. Operating parameters, such as variable data rates, FEC Code Rate, modulation type, IF Frequencies, IBS/IDR Framing and interface type can be readily set and changed at the Front Panel by earth station operations personnel.

The modem operates at all standard IBS and IDR Data Rates up to 8.448 Mbps. Selection of any data rate is provided over the range of 2.4 Kbps to 20 Mbps in 1 bps steps.

For applications requiring system redundancy, the Modem may be used with the Radyne RCS11 1:1 Redundancy Switch or the RCS20 M:N (N < 9) Redundancy Switch. An Internal Engineering Service Channel Unit is available to provide voice, data, and alarms for Intelsat IDR applications.

A full range of Industry Standard Interfaces are available. Interface types are selectable from V.35, RS-232, RS-422/-530, ITU G.703, HSSI, ASI, DVB/M2P and Ethernet Bridge.

The DMD20 LBST (Figure 1-2) offers additional features that are not included in the standard DMD20 Modem. The features included in DMD20 LBST serves as an interface between the indoor unit (DMD20 LBST) and the outdoor units (consisting of the BUC and LNB). The output frequency of the LBST is 950 to 2050 MHz. It does not offer a 70 MHz output that is included in the standard unit. The LBST can supply voltage and 10 MHz reference to the BUC and LNB via the IFL Cable. The output from the Tx Port consists of the L-Band output frequency, high-stability 10 MHz reference, FSK communications and either 24 or 48 Volts to the BUC. The Rx Port consists of the L-Band input frequency, high-stability 10 MHz reference and 13, 15, 18, and 21 volts.

The LBST has the capability to enable and disable the BUC/LNB voltages and 10 MHz reference via the front panel. In addition, monitoring features provide verification of system status. The LBST monitors both the current and the voltage at the output of the Tx and Rx Ports, thus allowing the user to monitor the status of both the indoor units and outdoor units.

1.2 Configurations

The DMD20/DMD20 LBST can be configured in the following different ways:

- features and options that are installed when the unit is ordered
- feature upgrades
- hardware options that are installed to a unit that is sent to a Radyne facility
- hardware options that the user can install at their own location

1.2.1 Features/Options Installed at Time of Order

Features installed at the time of ordering are the options pre-installed/initialized in the factory prior to shipment. These can be reviewed from the front panel system menu. Refer to Section 4, User Interfaces for information on how to view these features.

Factory installed options are chassis and board configurations that are introduced during manufacturing.

1.2.2 Feature Upgrades

Feature Upgrades are soft upgrades that can be easily be enabled on the modem. Enabling new features are done remotely or through the front panel of the modem. Features may be purchased at any time by contacting a Radyne Corp. salesperson. Refer to Section 4 and Appendix B, for information on how upgrade features are enabled.

1.2.3 Hardware Options

Hardware options (refer to Appendix A) are purchased parts that can be installed into the unit at the customer's site. A screwdriver is normally the only tool required. Please contact the Radyne Corp. Customer Service Department for information pertaining to availability and to shipping costs.



Only authorized service personnel should handle and install optional hardware options.

1.2.4 Factory Installed Options

Units may also be sent to the factory for hardware option installation. Please contact the Customer Service Department for information not limited to availability and to shipping costs.

1.3 Function Accessibility

All functions can be accessed through the front panel, terminal or personal computer via a serial link or via the Ethernet port offering a complete remote monitoring and control capability.

BLANK PAGE

Chapter 2. INSTALLATION

2.1 Unpacking and Inspection

Inspect shipping containers for damage. If shipping containers are damaged, keep them until the contents of the shipment have been carefully inspected and checked for normal operation. The Universal Satellite Modem and its Installation and Operation Manual are packaged and shipped in a pre-formed, reusable cardboard carton containing foam spacing for maximum shipping protection.



Do not use any cutting tool that will extend more than 1/2 inch into the container. This can cause damage to the modem.

Unpack and inspect the modem as follows:

Step	Procedure
1	Cut the tape at the top of the carton indicated by OPEN THIS END.
2	Remove the cardboard/foam space covering the modem.
3	Remove the modem, power cord, and user's manual from the carton.
4	Save the packing material for storage or reshipment purposes.
5	Inspect the equipment for any possible damage incurred during shipment. Note: If damage is evident, contact the carrier and Comtech EF Data immediately and submit a damage report.
6	Check the contents against the packing list to verify completeness of the shipment.
7	Refer to the sections that follow for further installation instructions.

The Universal Satellite Modem was carefully packaged to avoid damage and should arrive complete with the following items for proper installation:

1. DMD20/DMD0=20LBST Universal Satellite Modem
2. Power Cord, six foot with applicable AC Connector
3. Installation and Operation Manual



IMPORTANT Should the AC power cable connector be of the wrong type for the installation, either the cable or the power connector end should be replaced.

2.2 Installation Requirements

The modem is shipped fully assembled. It does not require removal of the covers for any purpose in installation. The power supply itself is designed for universal application using from 100 to 240 VAC, 50 to 60 Hz, 1.0A.



There are no user-serviceable parts or configuration settings located inside the Chassis. There is a potential shock hazard internally at the power supply module. DO NOT open the Chassis under any circumstances.



The unit contains a Lithium Battery. DANGER OF EXPLOSION exists if the battery is incorrectly replaced. Replace only with the same or equivalent type recommended by the manufacturer. Dispose of used batteries in accordance with local and national regulations.



Before initially applying power to the unit, it is a good idea to disconnect the transmit output from the operating ground station equipment. This is especially true if the current configuration settings are unknown, where incorrect settings could disrupt existing communications traffic.

2.3 Removal and Assembly

The Modem is shipped fully assembled. It does not require removal of the covers for any purpose in installation.



Always ensure that power is removed from the before removing or installing any optional modules. Failure to do so may cause damage to the equipment.

Carefully unpack the unit and ensure that all of the above items are in the carton. If the available AC mains power at the installation site requires a different cord set from the one included in the package, then a suitable and approved cord set (for the country where the equipment is to be installed) will be required before proceeding with the installation.

Should the Power Cable/AC Connector be of the wrong type for the installation, either the cable or the power connector end should be replaced. The power supply itself is designed for universal AC application. See specifications for appropriate voltages and currents.

2.4 Mounting Considerations

The can be installed within any standard 19 inch equipment cabinet or rack. The unit is a one rack unit (RU) mounting space (1.75 inches) vertically and 19 inches of depth and requires a minimum rack depth of 22 inches for cabling. The rear panel of the DMD50 is designed to have power enter from the left and IF Cabling enter from the right when viewed from the rear of the unit. Data and control cabling can enter from either side based on data interface option. The unit can be placed on a table or suitable surface if required

When mounted in an equipment rack, adequate ventilation must be provided. The ambient temperature in the rack should be between 10° and 35° C, and held constant for best equipment operation. The air available to the rack should be clean and relatively dry. The DMD50 units may be stacked one on top of the other up to a maximum of 10 consecutive units before providing one RU of space for airflow. Demodulator units should not be placed immediately above a high heat or EMF generator to ensure the output signal integrity and proper receive operation.

Do not mount the in an unprotected outdoor location where there is direct contact with rain, snow, wind or sun. The is designed for indoor applications only.

Shielded cables with the shield terminated to the conductive backshells are required in order to meet EMC directives. Cables with insulation flammability ratings of 94 VO or better are required in order to meet low voltage directives.



The unit CANNOT have rack slides mounted to the side of the chassis. Cooling fans are mounted on the right-hand side of the unit.

If the unit is to be mounted in a rack, ensure that there is adequate clearance for ventilation, particularly at the sides. In rack systems where there is high heat dissipation, forced air cooling must be provided by top or bottom mounted fans or blowers. Under no circumstance should the highest internal rack temperature be allowed to exceed 50°C (122°F).



PROPER GROUNDING PROTECTION REQUIRED: The installation instructions require that the integrity of the protective earth must be ensured and that the equipment shall be connected to the protective earth

connection at all times. Therefore, it is imperative during installation, configuration, and operation that the user ensures that the unit has been properly grounded using the ground stud provided on the rear panel of the unit.

- In Finland: **"Laitte on liitettävä suojamaadoituskoskettimilla varustettuun pistorasiaan."**
- In Norway: **"Apparatet må tilkoples jordet stikkontakt."**
- In Sweden: **"Apparaten skall anslutas till jordat uttag."**

2.5 Initial Configuration Check

The is shipped from the factory with preset factory defaults. Upon initial power-up, a user check should be performed to verify the shipped modem configuration. Refer to Section 4, User Interfaces to locate and verify that the following configuration settings are correct:



IMPORTANT

Transmit (Tx) and Receive (Rx) Interface types are dependent upon the customer's order.



IMPORTANT

Implementing Strap Code 26 can set the following modem configuration. Refer to Table D-1 for an explanation and tabular listing of available Strap Codes. The Frequency and Modulator Output Power are set independently of the strap code.

Standard Factory Configuration Settings**Modulator:**

Data Rate:	2.048 Mbps
Mode:	Closed Network
Satellite Framing:	None
Scrambler:	V.35 (IESS)
Drop and Insert:	Disabled
Inner FEC:	1/2 Rate Viterbi
Outer FEC:	Disabled
Modulation:	QPSK
Frequency:	70.000000 MHz
Modulator Output Power:	-20 dBm

Demodulator:

Data Rate:	2.048 Mbps
Mode:	Closed Network
Satellite Framing:	None
Scrambler:	V.35 (IESS)
Drop and Insert:	Disabled
Inner FEC:	1/2 Rate Viterbi
Outer FEC:	Disabled
Modulation:	QPSK
Frequency:	70.000000 MHz

To lock up the modem, enter 'IF Loopback Enable' under the Test Menu, or connect a Loopback Cable from J11 to J13 on the rear panel of the modem.

2.6 Modulator Checkout

The following descriptions assume that the unit is installed in a suitable location with prime AC power and supporting equipment available.

2.6.1 Initial Power-Up



Before initial power up of the unit, it is a good idea to disconnect the transmit output from the operating ground station equipment. This is especially true if the current Modulator Configuration Settings are unknown, where incorrect settings could disrupt the existing communications traffic. New units from the factory are normally shipped in a default configuration which includes setting the transmit carrier off.

Turn on the unit by placing the Rear Panel Switch (located above the power entry connector) to the On Position. Upon initial and subsequent power-ups, the Microprocessor will test itself and several of its components before beginning its Main Monitor/Control Program. These power-up diagnostics show no results if successful. If a failure is detected, the Fault LED will illuminate.

The initial field checkout of the modem can be accomplished from the Front Panel or in the Terminal Mode. The Terminal Mode has the advantage of providing full screen access to all of the modem's parameters, but requires a separate terminal or computer running a Terminal Program. The Terminal Mode is enabled from the front panel in the System M&C Submenus.

2.6.2 Factory Terminal Setup

The factory terminal setup is as follows:

Emulation Type:	VT-100 (can be changed)
Baud Rate:	19.2 K (can be changed via Front Panel)
Data Bits:	8
Parity:	No Parity (Fixed)
Stop Bits:	1 Stop Bit

Chapter 3. THEORY OF OPERATION

3.1 Modem Hardware

The modem is based on a two printed circuit card (minimum configuration) design with additional optioned printed circuit cards available for additional features. The minimum configuration consists of an L-Band/IF Assembly and a Digital Baseband Assembly. The optional printed circuit cards include a Turbo Codec printed circuit card and one of several types of Interface printed circuit card (refer to Appendix A). A block diagram of the Modem is shown in Figure 3-1.

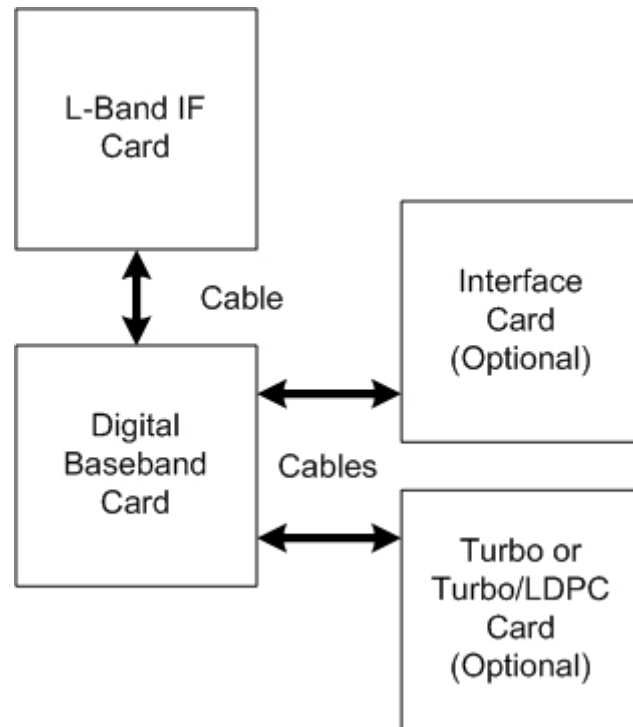

Figure 3-1 Block Diagram

3.1.1 L-Band/IF Printed Circuit Card

The L-Band/IF Printed Circuit Card consists of an analog modulation function, an analog complex down conversion, and two wide-band digital synthesizers. The block diagram of the L-Band/IF Assembly is shown in Figure 3-2.

In the modulator, analog in-phase (I) and quadrature (Q) signals are generated on the Digital Baseband Printed Circuit Card, routed to the L-Band/IF Printed Circuit Card, and modulated at the desired frequency. The L-Band or 70/140 modulated signal is then passed through a microprocessor controlled variable attenuator providing gain control of the output signal.

In the complex downconverter, the signal for demodulation is amplified and sent through a variable wideband attenuator for AGC. The gain-controlled signal is then passed through a complex downconverter to a low IF.

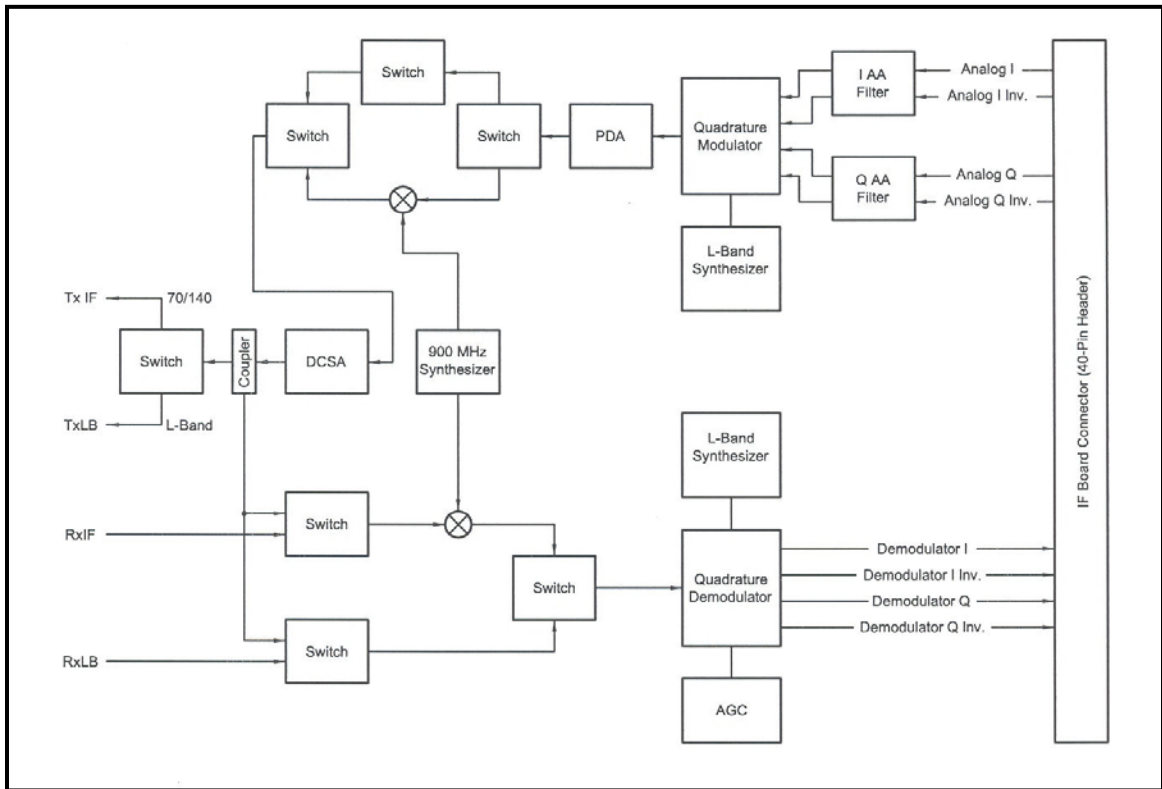

Figure 3-2 IF Card Block Diagram

3.1.2 Baseband Processing Printed Circuit Card

The advent of million-plus gate count FPGAs, advanced logic synthesis tools, and DSPs providing hundreds of MIPS enabled the design of a software configurable modem. Large, fast FPGAs now provide designers with what is essentially an on the fly programmable ASIC. High speed, complex digital logic functions that previously could only be implemented in dedicated integrated circuits are now downloaded from a micro-controller through a serial or peripheral interface. When a new digital logic function is needed, a new configuration file is loaded into the FPGA. There is no limit to the number of digital logic configurations available to the FPGA, aside from the amount of Flash memory available to the system microprocessor for storage of configuration files.

The Baseband Processing Printed Circuit Card provides a flexible architecture that allows many different modes of terrestrial and satellite framing, various FEC options, digital voice processing, and several different modulation/demodulation formats. Also included on the Baseband Printed Circuit Card are three synchronous interfaces, an EIA-530 Interface supporting RS-422, V.35, and RS-232. All three interfaces are provided on the same DB-25 Connector, and are selectable from the front panel.

The Baseband Printed Circuit Card also contains the Monitor and Control (M&C) Circuitry responsible for:

- Programmable part setup and initialization
- Continuous control and adjustment of some functions
- Calibration
- Monitoring fault status
- Calculating and displaying measurements
- User monitor and control interface including front panel and remote
- Units configuration and feature set

The M&C System is based on a powerful microprocessor with a large amount of Flash memory. Several bus architectures are used to interconnect the M&C to all components of the modem. Communication to the outside world is done via connections to the remote port, terminal port, Ethernet port, and alarm ports. The M&C runs off of software programmed into its Flash memory. The memory can be reprogrammed via the Ethernet port to facilitate changes in software.

3.1.3 Enhanced Interface Printed Circuit Card

The normal terrestrial data for the Baseband Processing Card can be re-routed to the enhanced interface card. The enhanced interface card adds a variety of connections to the modem for additional applications

3.2 Functional Block Diagram

Figure 3-3 represents the Functional Blocks. The modem is shown in a typical application with customer data, Tx/Rx RF equipment and an antenna.

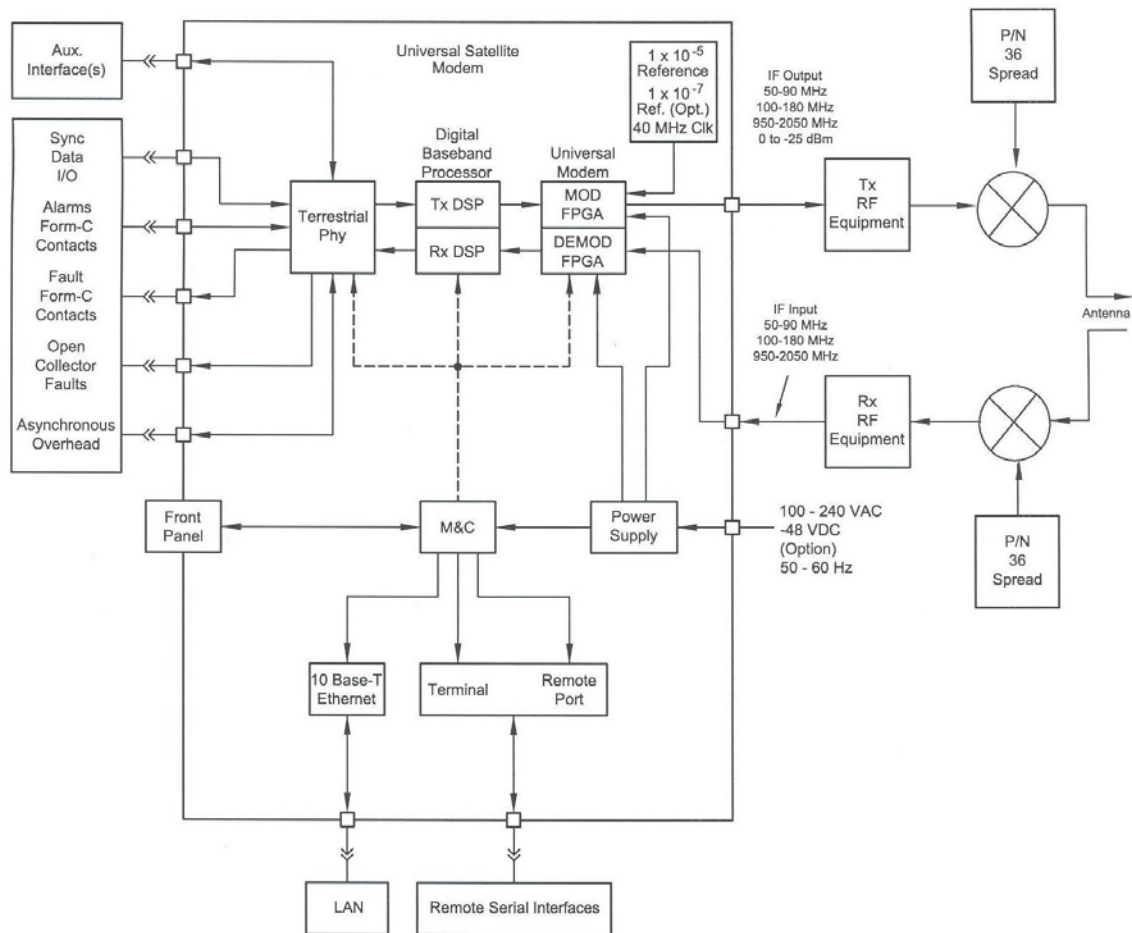

Figure 3-3 Universal Satellite Modem Functional Block Diagram

3.2.1 Front Panel

The Front Panel includes a 2 x 16 backlit LCD Display, Indicator LEDs, and a Numeric Keypad (refer to Chapter 4).

3.2.2 Baseband Processing

The Baseband Processor performs all of the functions required for an IBS/IDR Framing Unit, a Reed-Solomon Codec, and an E1/T1 Drop and Insert System. In addition, the Baseband Processing Section provides for transmit clock selection and rate adaptation as well as a rate adapter and Plesiochronous/Doppler (PD) Buffer in the receive direction. A multiplexer is also provided for the SCT Clock Source for Loop Timing Applications. The transmit and receive paths may be configured independently under processor control.

3.2.3 Tx Baseband Processing

The Tx Data and Clock enters the Baseband Processor, passes through a Rate Adapting FIFO and enters the Framer/Drop Processor. In IDR, IBS, and D&I Modes, the framer adds the appropriate framing and ESC as defined in IESS-308 and 309. In D&I Mode, the framer acquires the terrestrial framing structure, E1 or T1, and synchronizes the Drop Processor. The Drop Processor extracts the desired time slots from the terrestrial data stream and feeds these channels back to the framer. The framer then places the 'dropped' terrestrial time slots into the desired satellite channel slots. The data is then sent to the Reed-Solomon Encoder.

When enabled, the Reed-Solomon Encoder, encodes the data into Reed-Solomon Blocks. The blocks are then interleaved and synchronized to the frame pattern as defined by the selected specification (IESS-308, IESS-309, DVB, etc.). After Reed-Solomon Encoding, the composite data and clock are applied to the BB Loopback Circuit.

3.2.4 Rx Baseband Processing

The Receive Processor performs the inverse function of the Tx Processor. Data received from the satellite passes through the BB Loopback Circuit to the Reed-Solomon Decoder to the Deframer. The Deframer acquires the IBS/IDR/DVB frame, synchronizes the Reed-Solomon Decoder and extracts the received data and overhead from the frame structure, placing the data into the PD Buffer, sending the overhead data to the UIM. The data is extracted from the buffer and is sent to the UIM. Backward Alarm indications are sent to the M&C Subsystem. In Drop and Insert Mode, the Insert Processor synchronizes to the incoming terrestrial T1/E1 Data Stream, extracts satellite channels from the PD Buffer, and then inserts them into the desired terrestrial time slots in the T1/E1 Data Stream.

3.3 Monitor & Control (M&C) Subsystem

The modems M&C system is connected to most of the circuitry on any board contained in the modem. These connections provide status on the working condition of the circuitry as well as providing the data required for the various measurements the modem provides. The M&C processes this information and generates status indications as well as alarms when necessary. Detailed status information is available via the modems various user interfaces including the remote and terminal ports. An external summary fault is available on the RS422 Data interface

The M&C contains a high-performance microprocessor and is responsible for overall command and control of modem functions. The M&C is constantly monitoring all subsystems of the modem by performing a periodic poll routine and configures the modem by responding to commands input to the system. During each poll cycle, the status of each of the subsystems is collected and reported to each of the external ports. Performance statistics such as Eb/No, buffer fill %, etc. are compiled. If faults are detected, the M&C will take appropriate actions to minimize the effect of such faults on the system (refer to the Fault Matrices in Chapter 6).

The modem supports the following M&C protocols:

- Terminal Interface (Section 3.3.1)
- Remote Port Interface (Section 3.3.2)
- Ethernet M&C, Web Browser & SNMP (Section 3.3.3)
- Modem Status, Alarms & Contact Closures (Section 3.3.4)

3.3.1 Terminal Port

This port supports an asynchronous control protocol as described in Chapter 4. It is configured to support RS-232 signal levels. This port is intended for use in computer-based remote M&C. All functions of the modem may be monitored and controlled from this port via a common terminal connected to the Terminal Port. This function is front panel selectable.

The Terminal Mode Control allows the use of an external terminal or computer to monitor and control the modem from a full screen interactive presentation operated by the modem itself. No external software is required other than VT-100 Terminal Emulation Software (e.g. "Procomm" for a computer when used as a terminal. The Control Port is normally used as an RS-232 Connection to the terminal device. The RS-232 operating parameters can be set using the modem Front Panel and stored in Non-volatile memory for future use.



IMPORTANT

Refer to the Remote Protocol Manual (MN-DMDREMOTEOP) for the Terminal, Remote and SNMP screens and protocols.

3.3.2 Modem Remote Communications (RLLP)

The Remote Port located on J20 allows for control and monitoring of parameters and functions via an RS-232 Serial Interface, or RS-485 for RLLP Protocol. 'Equipment Remote Mode' setup can be entered from the front panel or the Web Browser interface under the "System" menu. This requires the user to first set the Remote Port Control to "Remote" then set the Multidrop Address as needed followed by setting the Remote Interface to RS232 or RS485.

Control and status messages are conveyed between the modem and all subsidiary modems and the host computer using packetized message blocks in accordance with a proprietary communications specification. This communication is handled by the Radyne Link Level Protocol (RLLP), which serves as a protocol 'wrapper' for the RM&C data. Complete information on monitor and control software is contained in the following sections.

3.3.3 Ethernet M&C Port

This port is dedicated for Ethernet Communications supporting SNMP, FTP and Web Browser. The port is configured for 10 Base-T communications protocols. The Ethernet M&C Interface requires a standard RJ45 Male connector. Refer to Appendix E and F for proper setup of the TCP-IP interface and Web Browser Setup.

3.3.4 Modem Monitor Status

The modems M&C system is connected to most of the circuitry on any board contained in the chassis. These connections provide status on the working condition of the circuitry as well as providing the data required for the various measurements the modem provides. The M&C processes this information and generates status indications as well as alarms when necessary. Detailed status information is available via the modems various user interfaces (front panel, remote and terminal). A summary of this information can be connected to external equipment, switches or alarms via the open collector and/or form-C fault connections

Form-C Contacts:

The UIM provides three Form-C Relays under processor control that appear at J15.

Mod Fault: De-energized when any transmit side fault is detected.

Demod Fault: De-energized when any receive side fault is detected.

Common Fault: De-energized when any fault that is not explicitly a Tx or Rx Fault such as an M&C or Power Supply Fault.

Open Collector Faults:

The UIM provides two Open Collector Faults that appear at Pins 18 & 21 on J19.

Mod Fault: Will sink up to 20 ma (maximum) until a transmit or common fault is detected. Will not sink current if a fault is detected.

Demod Fault: Will sink up to 20 ma (maximum) until a receive or common fault is detected. Will not sink current if a fault is detected.

The open collector faults are intended for use in redundancy switch applications in order to provide quick status indications.

3.4 Async Port / ES-ES Communications

This port is dedicated for ES-ES Communications supported by either RS232 or RS485 signal levels. The baud rate and protocol can be selected from the Front Panel. The port may be configured for a number of communications protocols. Overhead data to/from the UIM is routed to/from the framer/deframer. This port is also used by SCC Framing for the in-band data.

3.5 Internal Clock

The time and date is kept in order to 'time-tag' system events. User can change the Internal Clock via the front panel, Web Browser or Terminal ports.

3.6 Loopback Features (Terrestrial & IF)

The modem provides for a number of different loopbacks. The Loopback supported are:

- IF Loopback – Tx IF port is looped back to the Rx IF port
- TX Terrestrial Loopback - Tx Data port is looped back to the Rx Data port after the interface driver/receiver. (prior to the framing unit)
- TX Baseband Loopback - Tx Data port is looped back to the Rx Data port after the interface driver/receiver. (after the framing unit)
- RX Terrestrial Loopback - Receive Data from the satellite is looped back for retransmission to the satellite, providing a far end loopback. (prior to the framing unit)
- RX Baseband Loopback - Receive Data from the satellite is looped back for retransmission to the satellite, providing a far end loopback. (after to framing unit)
- TX/RX Terrestrial Loopback - provides both Terrestrial loopbacks simultaneously
- TX/RX Baseband Loopback - provides both Baseband loopbacks simultaneously



Usage of the modems loopback capabilities in conjunction with the Ethernet data interface can produce undesirable network loops. In order to run any type of data test with an Ethernet interface you must utilize two modems connected back to back. Simply using one modem and a loopback will not produce the desired results.

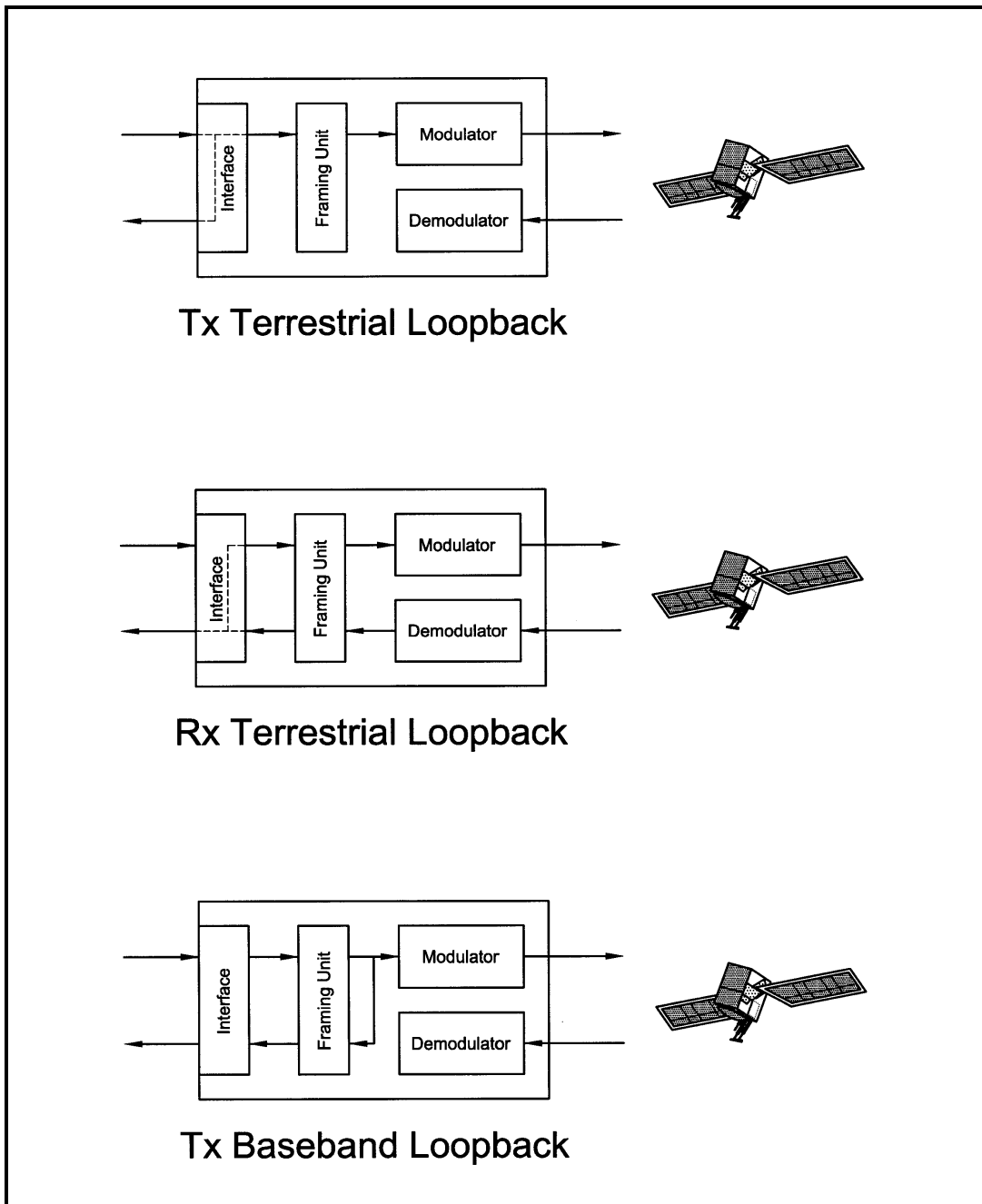

Figure 3-4 Loopback Functional Block Diagram

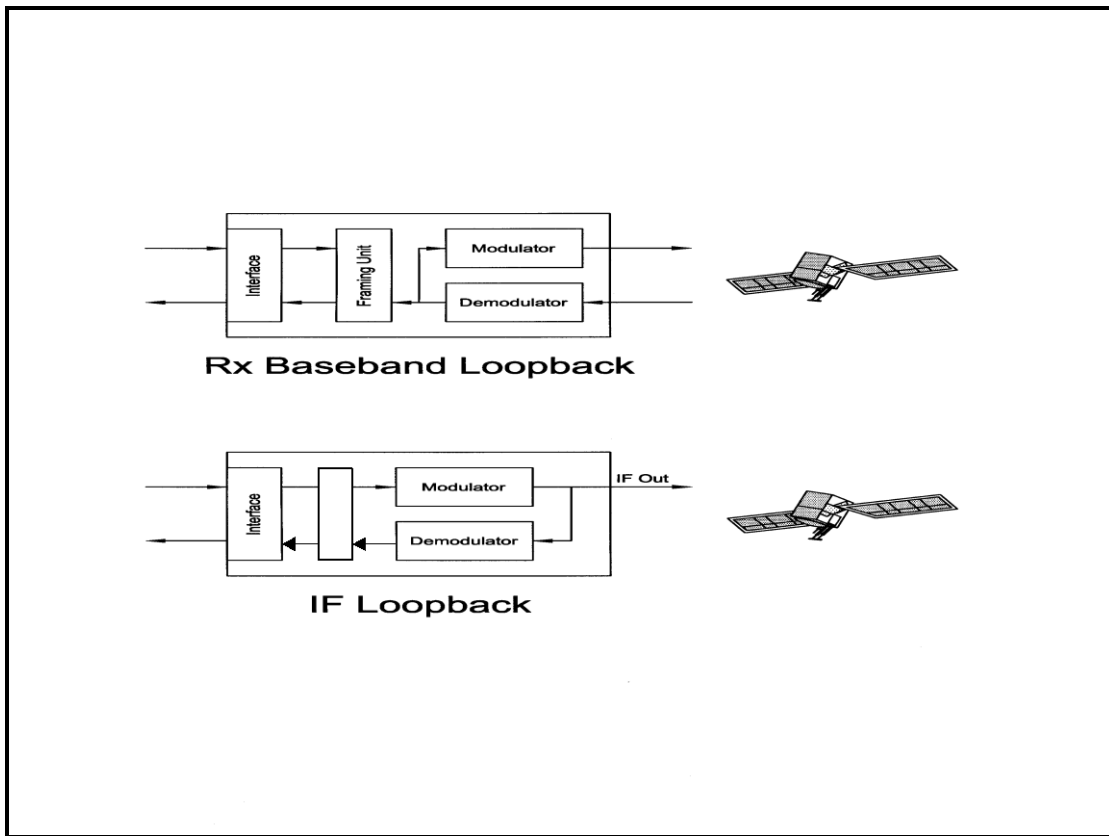

Figure 3-5 Loopback Functional Block Diagram

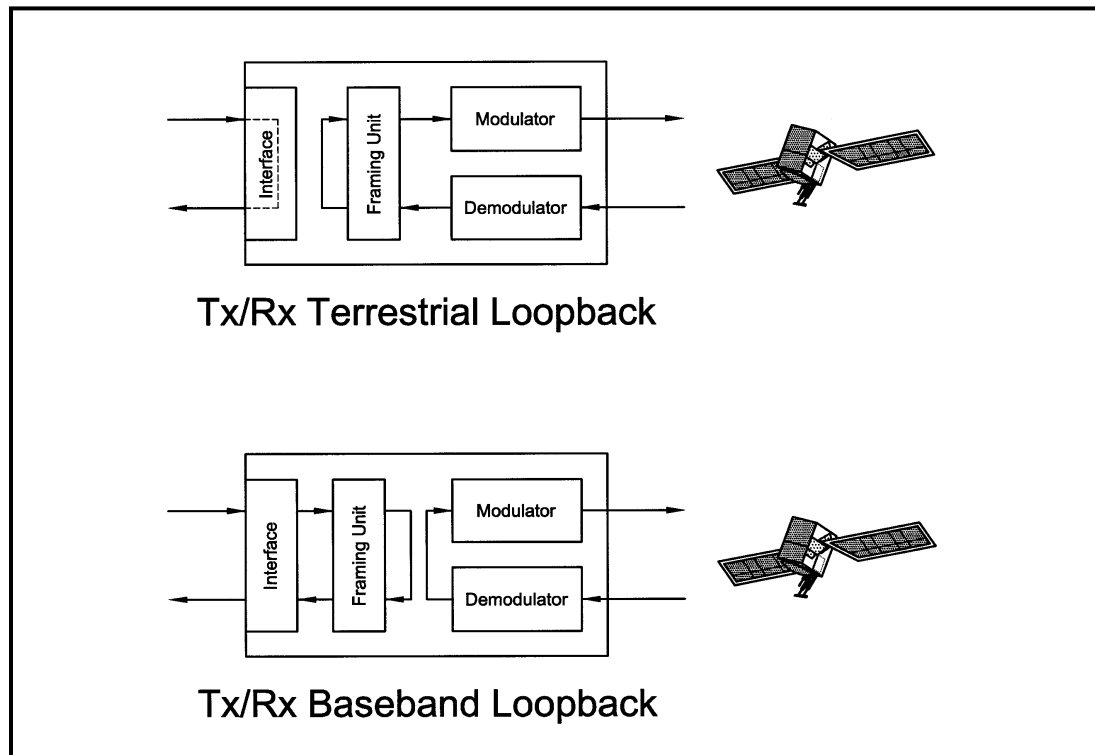

Figure 3-6 Loopback Functional Block Diagram

3.7 Clocking Options

The modem supports a number of different clocking options that can be recovered from the satellite or the terrestrial links. The various clocking options allow users to determine which clock will best fit their applications. Figure 3-7 gives an overview on how the modem processes the various clocks for the Tx Clock source and the Rx Buffer Clock source. Tx and Rx Clocks may be independently locked.

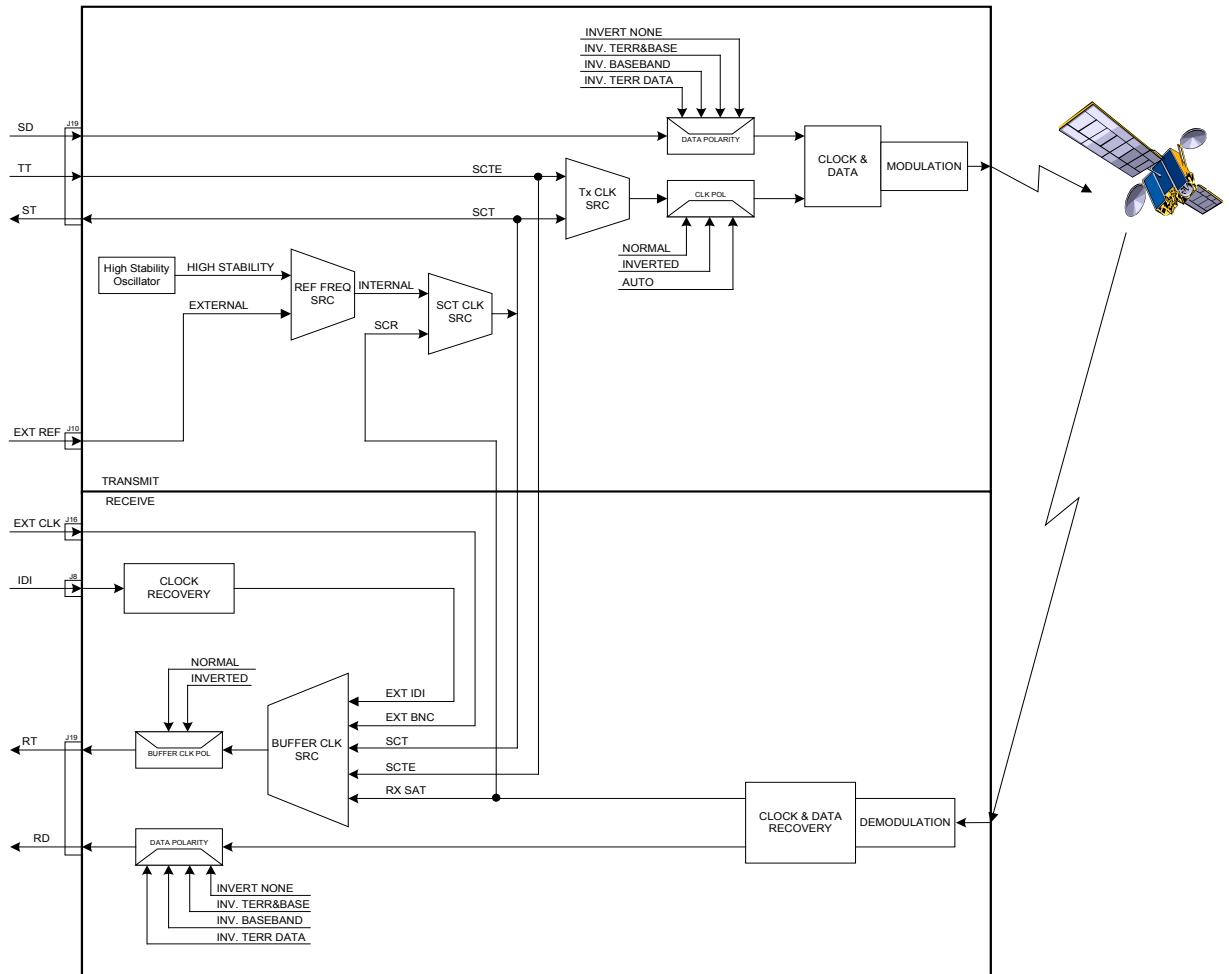

Figure 3-7 Clocking and Polarity Diagram

3.7.1 TX Clock Options

TX clock options can be recovered from the terrestrial interface, satellite interface or internally generated. This allows users to select SCTE Clock (Terrestrial) or the SCT internal clock. The modem also allows user to recover the SCT Clock from the satellite (SCR) or from the modem internally. The modem allows users to select clock polarity. The Tx clock selections available are:

The following paragraphs define the types of clocking options available to the user at the Front Panel.

- SCT (Internal Oscillator)
- SCTE (External Tx Terrestrial Clock)
- Rx Satellite Clock

3.7.1.1 SCTE: Serial Clock Transmit External

The SCTE clock is the Transmit Terrestrial Clock associated with the data interface. SCTE is an external clock received from the terrestrial equipment and the modem utilizes the terrestrial clock to lock the internal clock.

In Figure 3-7, the Transmit Terrestrial Data enters the modem and is clocked into a dejitter FIFO. Data is clocked out of the FIFO by the Modulator Clock. The Modulator Clock and Phase-Locked Loop (PLL), in conjunction with the Dejitter FIFO, which reduces the input jitter. Jitter reduction exceeds the jitter transfer specified in CCITT G.821.

SCTE is sometimes referred to as Tx Terrestrial Timing or Terminal Timing. Terminal Timing is reference to the RS422 synchronous interfaces.

3.7.1.2 SCT: Serial Clock Transmit

The SCT clock can be generated internally or recovered from the satellite. The SCT clock source can be used as the TX clock source, RX Buffer Clock source and the Terrestrial Terminal equipment for clocking the transmit data. If the SCT clock is recovered from the satellite, then it is referred to as SCR. SCR is also referred to as Receive Clock, Satellite Clock, or Receive Timing (RT).

When SCT clock is configured as Internal, the frequency of the clock is set the same as the Transmit Terrestrial Clock rate. If SCT clock is configured as SCR, the internal clock is set to the same rate as the incoming receive satellite clock. SCT is sometimes referred to as Internal Timing or Send Timing (ST). In the event that the satellite clock is lost, the modem will automatically switch over to the Internal Clock and revert back to SCR when activity is detected.

If SCT is selected, then Terrestrial data that is synchronous to the SCT Clock is required to be supplied by the modem. It is intended for the terminal equipment to use the SCT as its clock source. The Autophase Circuit will automatically ensure that the data is clocked correctly into the modem. Therefore, a return clock is not necessary. The Clock Polarity should be set to Auto.

3.7.2 RX Buffer Clock Options

The modem supports a number of RX Buffer clock options that can be recovered from the satellite, terrestrial links, internally or externally. The various clocking options allow users to determine which clock will best fit their applications. Figure 3-7 gives an overview on how the modem processes the various clocks for the Tx Clock and the Rx Buffer Clock. The modem allows users to select clock polarity Tx and Rx Clocks may be independently locked. The following RX Buffer clock selections are available:

- Rx Satellite Clock (Recovered from Satellite)
- SCTE (External Tx Terrestrial Clock)
- SCT (Internal Oscillator)
- EXC Clock/EXT BNC (External Clock Source)
- EXT IDI (Drop and Insert)

The modem handles RX Buffer clock selections based on source priority levels. The user assigns priorities to the clock sources based on source selections. Source 1 has the highest priority and Source 5 being the last resort or lowest priority. If a fallback clock is selected and activity is lost at the highest priority source, the modem will fall back to the next highest priority clock with activity. When activity resumes on a higher priority source, the modem resumes using the higher priority source

<u>Clock Source</u>		<u>Priority</u>	
RX SAT	1	of	5
SCTE	2	of	5
SCT	3	of	5
EXC BNC	4	of	5
EXT IDI	5	of	5

Refer to Front panel setup menus or Web Browser manual MN-DMDREMOTEOP.

3.7.2.1 RX SAT Clock

The RX Sat clock is recovered from the satellite that is received from the distant end. If selected the Buffer Clock is lock to the RX sat clock.

3.7.2.2 CTE: Serial Clock Transmit External

When SCTE is selected as the Rx Buffer clock, the modem receives the clock from the Transmit Terrestrial interface.

3.7.2.3 SCT: Serial Clock Transmit

If SCT clock is selected as the RX Buffer clock source, then it should be configured for internal. SCT is sometimes referred to as Internal Timing or Send Timing (ST).

3.7.2.4 EXT CLK/EXT BNC: External Clock, J16

The External Clock that can be selected as the RX Buffer clock source. This is a 75ohm unbalanced BNC connector. This clock source is also identified as EXT BNC. The External Clock is often used as the station master clock. The RX Clock selection can be accessed in the INTERFACE/RX SETUP menu. The clock frequency, EXT FREQ can be selected, in the Interface/General Menu.

Clock specification:

Frequency:	1 MHz to 20 MHz
Level:	0.5 Vp-p to 5 Vp-p

3.7.2.5 EXT IDI: Insert Data In

External IDI is used only for E1/T1 Drop and Insert applications. The available T1/E1 Frame Source selections are External, Internal, and IDI/DDO Loopback. The T1/E1 Frame Source selections can be accessed in the INTERFACE/RX SETUP menus. If Ext IDI is selected as the RX Buffer clock, then user must first specify T1/E1 Frame Source.

- External (RX Buffer Clock recovered from the data)
- Internal (RX Buffer Clock recovered from the internal clock)
- IDI/DDO Loopback (RX Buffer Clock recovered from the data and looped back)

3.7.3 EXT REF: External Reference, Top BNC Port, J10

This is not actually a clock, but does have some clocking implications. When the external reference is used, the master oscillator within the modem is locked to the external reference, and the internal accuracy and stability of the unit assumes that of the External Reference. Therefore, not only are the transmit frequencies locked to the external reference, but the modem's internal SCT Oscillator is locked to the external reference as well.



External reference port input is specified at 0.1Vpp to 5.0Vpp (Sinewave or Squarewave).

3.8 RS530/422/V.35 Interface (Standard)

Data must be clocked into the modem by either the SCTE or SCT Source. If SCTE is selected as the Tx Clock Source, then SCTE must be supplied to the modem on the EIA-530 port. The output of the dejitter buffer will be clocked with this source. SCT should be used if SCTE has excessive jitter.

3.8.1 G.703 Interface (Optional)

If the G.703 Interface is selected, then the Tx Clock Source will default to SCTE and the Clock Polarity will default to Auto.

Loop timing with a G.703 Interface or Asymmetrical Data Rates requires external equipment at the remote end that is capable of using the recovered RD Clock as source timing for (SCTE) SD. The modem will not manipulate the clock frequency. Therefore, the transmit and receive clock rates must be equal in order for the modem to perform loop timing.

3.8.2 HSSI Interface (Optional)

If the HSSI Interface is selected, then the Tx Clock Source will default to SCTE and the Clock Polarity will default to Auto.

3.8.3 Ethernet Data Interface (Optional)

The modem support a 4 port 10/100 Base-T or a 10/100/1000 Base T Interface. When this interface is selected additional menus will be displayed. Refer to Appendix J for interface set up and description of supporting features.

When Ethernet Data Interface is selected, the Tx Clock Source will default to SCTE and the Clock Polarity will default to Normal. In addition, the Buffer Clock will default to RxSat and the Buffer Clock Polarity will default to Normal.



The DMD20 & 20LBST supports Radyne HDLC and Comtech HDLC modes, offering compatibility with the SLM5650A Bridge Interface.

3.9 Reed-Solomon Codec



Refer to Figure 3-8, Figure 3-9, and Table 3-1.

Utilizing a Reed-Solomon (R-S) Outer Codec concatenated with a Convolutional Inner Codec is an effective way to produce very low error rates even for poor signal-to-noise ratios while requiring only a small increase in transmission bandwidth. Typically, concatenating an R-S Codec requires an increase in transmission bandwidth of only 9 – 12% while producing a greater than 2 dB improvement in E_b/N_o . R-S is a block Codec where K data bytes are fed into the encoder which adds $2t = (N - K)$ check bytes to produce an N byte R-S block. The R-S decoder can then correct up to “t” erred bytes in the block.

3.9.1 Reed-Solomon Operation

When the Reed-Solomon Codec is enabled, data is fed to the R-S Encoding Section where it is scrambled, formed into blocks, R-S encoded, and interleaved. Unique words are added so that the blocks can be reformed in the Receiving Modem (Refer to Figures 3-14 and 3-15). Data is then sent to the modulator where it is convolutionally encoded, modulated and transmitted to the satellite.

When the signal is received and demodulated by the Receiving Modem, it is fed to a Viterbi Decoder for the first layer of error correction. After error correction is performed by the Viterbi Decoder, the unique words are located and the data is deinterleaved and reformed into blocks. The R-S Decoder then corrects the leftover errors in each block. The data is then descrambled and output from the R-S Section.

3.9.2 Reed-Solomon Code Rate

The R-S Code Rate is defined by (N, K) where N is the total R-S block size in bytes - data + check bytes - and K is the number of data bytes input into the R-S Encoder. The transmission rate expansion required by the R-S Codec is then defined by N/K . The modem automatically sets the correct R-S code rate for IDR/IBS open network operation in accordance with the data shown in Table 3-1. The modem allows the following N and K setting: (126, 112), (219, 201), (194, 178), (225, 205).

Variable Reed-Solomon rates are available on the optional AS/5167 Super Card. Refer to Appendix A for further information.

3.9.3 Interleaving

Interleaving depths of 4, 8, or 12 R-S blocks are allowed. This allows burst errors to be spread over multiple blocks in order to enhance the error correcting performance of the R-S Codec. For Intelsat Network Modes, the interleaving depth is automatically set to 4 for QPSK or BPSK, or 8 for 8PSK. In Closed Network Mode, the interleaver depth can be manually set to 4 or 8, and in DVB Network Mode, the interleaver depth is automatically set to 12.

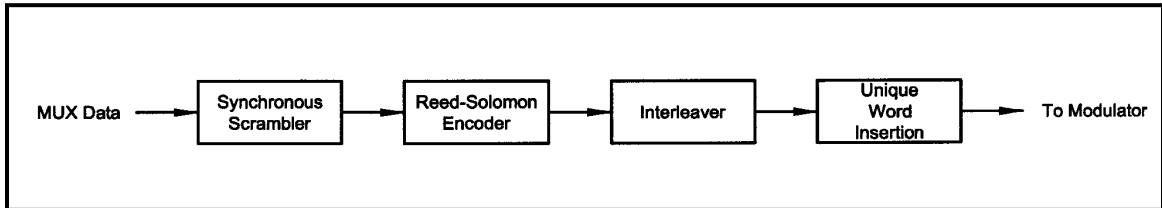

Figure 3-8 Reed-Solomon Encoder Functional Block Diagram

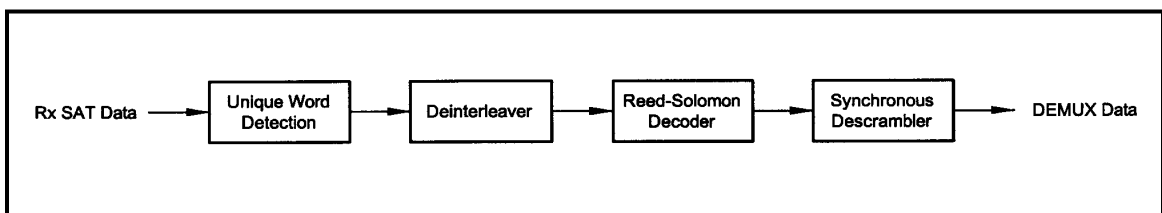

Figure 3-9 Reed-Solomon Decoder Functional Block Diagram

Table 3-1. Reed-Solomon Codes					
Type of Service	Data Rate (Kbps)	R-S Code (n, k, t) ¹	Bandwidth Expansion [(n/k) - 1]	Interleaving Depth	Maximum ² R-S Codec Delay (ms)
Small IDR (With 16/15 O/H)	64	(126, 112, 7)	0.125	4	115
	128	(126, 112, 7)	0.125	4	58
	256	(126, 112, 7)	0.125	4	29
	384	(126, 112, 7)	0.125	4	19
	512	(126, 112, 7)	0.125	4	15
	768	(126, 112, 7)	0.125	4	10
	1024	(126, 112, 7)	0.125	4	8
IDR (With 96 Kbps O/H)	1544	(225, 205, 10)	0.0976	4	9
	2048	(219, 201, 9)	0.0896	4	7
	6312	(194, 178, 8)	0.0899	4	2
	8448	(194, 178, 8)	0.0899	4	<2
8PSK	1544	(219, 201, 9)	0.0896	8	18
	2048	(219, 201, 9)	0.0896	8	13
	6312	(219, 201, 9)	0.0896	8	4
	8448	(219, 201, 9)	0.0896	8	3
DVB	All	(204, 188, 8)	0.0851	12	-

1. n = code length, k = information symbols and t = symbol error correcting capability.
 2. Design objective.

3.10 Asynchronous Overhead Operation (Framing/Multiplexer Capability)

The Asynchronous Framing/Multiplexer is capable of multiplexing a relatively low-speed overhead channel onto the terrestrial data stream resulting in a slightly higher combined or aggregate data rate through the modem. The overhead channel is recovered at the far end. This added channel is termed variously "An Overhead Channel", "Service Channel", "Async Channel" or in IESS terminology an "ES to ES Data Channel." The basic frame structure used by the multiplexer is that specified in the IESS-309 Standard, resulting in a 16/15 Aggregate ratio of overhead & data to data rates.

For Regular Async: (Standard IBS), the Baud Rate is approximately 1/2000 of the Data Rate listed in Table 3-2.

For Enhanced Async: (IBS Async.), the Baud Rate is selectable, but Data Rate is limited.

The maximum Baud Rate is 19,200 bps for IBS Async. Two software-controlled modes are designed into the card to best utilize the available bits; "Standard IBS" and "IBS (Async)". The characteristics of the Channel Interface are also determined by the standard or Async mode.

The Async Channel can be set under software-control to either RS-232 or RS-485 mode. The pin assignments for both modes are shown in Table 5-3.

The "RS-485" Setting controls the output into tri-state when the modem is not transmitting data, allowing multiple modem outputs to be connected together.

Kbps	Baud Rate Example for Standard IBS	Kbps	Baud Rate Example for Enhanced Mode
128	64	9.6	300
256	128	19.2	600
384	192	32	600
512	256	64	1200
640	320	128	2400
768	384	192	4800
896	448	256	4800
1024	512	320	9600
1152	576	384	9600
1280	640	448	9600
1408	704	512	9600
1536	768	576	9600
1664	832	640	19200
1792	896	704	19200
1920	960	768	19200
1920	960	768	19200
2048	1024	832	19200
		896	19200
		960	19200
		1024	19200
		1088	19200
		1152	19200

Table 3-2			
Kbps	Baud Rate Example for Standard IBS	Kbps	Baud Rate Example for Enhanced Mode
		1216	19200
		1280	19200
		1344	19200
		1408	19200
		1472	19200
		1536	19200
		1600	19200
		1664	19200
		1728	19200
		1792	19200
		1856	19200
		1920	19200
		1984	19200
		2048	19200

3.11 Standard IBS Mode

In the first or “Normal” mode, all bit assignments are per the IBS standard. The bits of Overhead Housekeeping byte 32 are implemented as shown in Table 3-3 below:

Table 3-3		
Bit 1	ES to ES Data Channel	This bit is routed directly to the ES to ES Data Channel. Its data rate is 1/512 th of the aggregate rate (or 1/480 th of the through terrestrial data rate), and is normally used to super-sample an asynchronous data channel.
Bit 2	Frame Alignment	Part of the Frame Alignment word.
Bit 3	Backward Alarm	Transmit and Receive with main processor to activate Main Alarm/LED.
Bit 4	Multiframe Message	As per IBS.
Bits 5 and 6	Spare	Not currently utilized.
Bits 7 and 8	Encryption Utilization	Not currently utilized.

The ratio of the Through Terrestrial Data Channel Rate to the aggregate rate is 15/16. The standard transmit and receive channels of the ES to ES Data Channel in Standard IBS Mode are raw channels operating at the specific bit rate as controlled by the data channel rate, without buffering. In addition, no clocks are provided with this channel. Since it would be rare that the data rate provided was exactly that required for a standard rate device, the only method of communicating using this channel is to allow it to super-sample the user data.

3.12 Asynchronous Multiplexer Mode

Since many of the frame bits in the standard IBS mode are not used, an “Enhanced” Multiplexer Mode has been implemented that can be engaged under software control. Since this mode changes the use of many of the framed non-data bits, this mode is only usable when the modem is at both ends of a link.

In this mode, the overhead signaling bytes 16 and 48 can be used to implement a significantly higher speed ES to ES Data Channel under software control. This rate is 16 times that of the normal IBS standard, or $1/30^{\text{th}}$ of the terrestrial data rate ($1/32^{\text{nd}}$ of the aggregate rate).



The IBS Async mode MUST be selected for true Asynchronous channel operation to be available.

3.13 ESC Backward Alarms

When running in IDR Mode and if the modem has the ESC Option, there will be four Backward Alarms available for use by the earth stations at each end of the link (both ends must have the ESC option). These alarms are accessed via the ESC ALARMS Port. The four alarms are controlled by four relays, each having a normally open, normally closed, and a common connection. The common connections of these relays (referred to as Backward Alarm Inputs) can be connected to whichever system on the earth station that the user wishes to trigger the backward alarm.

When ground is applied to the Common (Input) Connection of one of these relays, that relay and associated backward alarm will then be in a “no fault” state. When the ground is removed, the relay and the associated Tx Backward Alarm will toggle to the faulted state. When in the faulted state, the receive end of the link will receive that backward alarm that is initiated at the transmit end of the link.

The user can connect whichever systems on the earth stations that they desire to these Backward Alarms Relays as long as they will supply ground to the Backward Alarm Relay Input in the “no fault” condition and the ground will be removed in the “faulted” condition.

For example: the user could connect the Demod Summary Fault of the modem to the Backward Alarm 1 Input, so that if the demod went into Major Alarm (such as a Carrier Loss), Backward Alarm 1 would be transmitted to the receive end of the link. At the receive end, it would show up as Rx Backward 1 (Receive Backward Alarm 1).

3.13.1 To Disable the ESC Backward Alarms

If the ESC ALARMS Port will not be used and the Backward Alarm Indications are to be disabled, you must connect pins 10, 11, 22 and 23 to pin 1 (gnd) on ESC Alarms port.

3.14 Satellite Control Channel (SCC)

The SCC format uses a variable overhead rate to transmit an asynchronous data channel in addition to the normal data channel. The SCC asynchronous mode implemented on the DMD20 is "PassThru" Mode.

In Pass Thru Mode, there is no formatting or deformatting of the input data in the buffer, and it is transmitted on a first-in first-out basis. In band data entering the remote port is inserted into the user data stream. The in-band data is received and passed on to the user without any deformatting or depacketizing involved. The maximum in band rate supported is 115200bps.

The Asynchronous Data Interface (J17) is a 9-Pin Female “D” Connector. The data interface is either RS232 or RS485 via a front panel selection. Refer to Table 5-7 for pinouts.

3.14.1 SCC Framing Structure

Each SCC frame consists of the following:

- A 10-bit synchronization pattern called the Synchronizing Word.
- Multiple variable length slots filled with user data.
- Multiple 10-bit control words that contains eight bits of in-band data (the extra two bits are for the async start/stop).

The number of user data slots and control words per frame is selected by the SCC Control Ratio Parameter. This can be any value from 1 to 1 through 1 to 7. A higher ratio allows a lower overhead rate but since there are less Sync Words, there is a higher acquisition time.

The following examples show a control ratio of 1 to 3 and 1 to 1. Example 1 shows three Control Words for every Synchronizing Word, and Example 2 shows one Control Word for every Synchronizing Word.

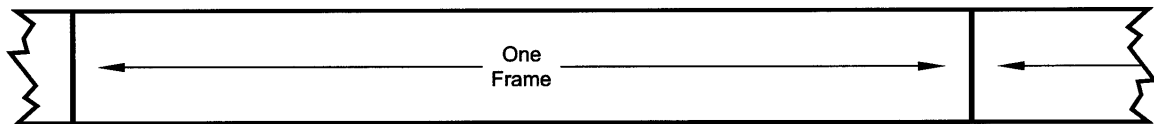
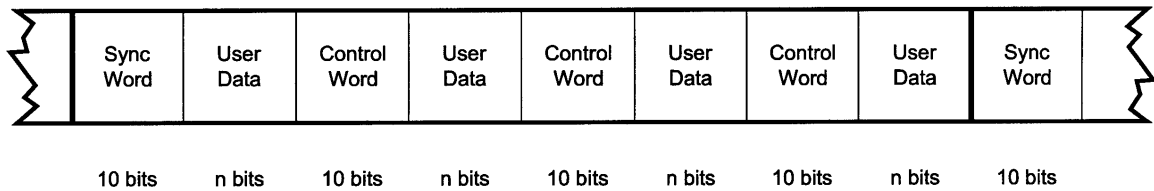

1 to 3 Control Ratio

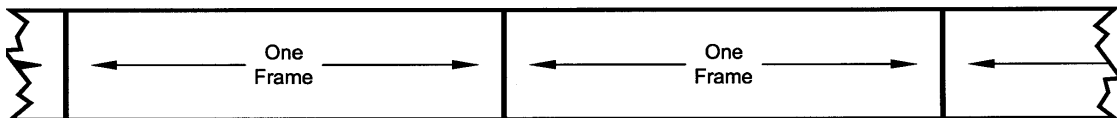
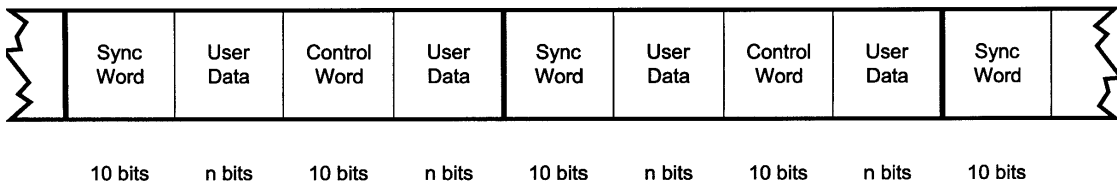

1 to 1 Control Ratio

The Control Ratio of the receiving units must match the Control Ratio of the transmitting unit.

3.14.2 Aggregate Data Rate

The aggregate data rate equals:

$$\text{User Data Rate} + \text{In-Band Rate} + \text{Synchronizing Overhead Rate}$$

Because SCC adjusts the overhead so that there are an equal number of user data bits in each slot, the synchronizing overhead cannot be easily calculated. However, dividing the In-Band Rate by the Control Ratio can approximate it. The basic calculation of this rate is shown:

$$\text{Aggregate Data Rate} = \text{User Data Rate} + \text{In-Band Rate} + (\text{In-Band Rate}/\text{Control Ratio})$$

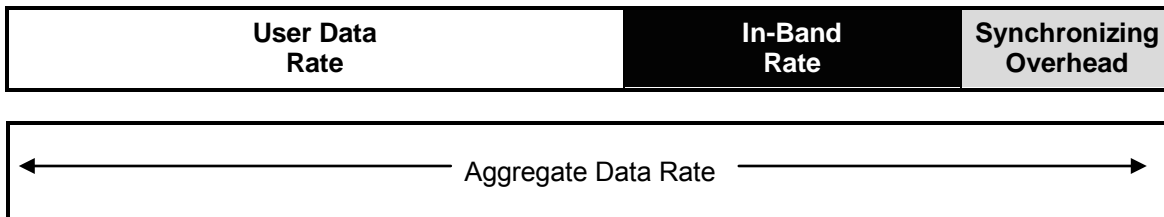

As an example, given the following parameters:

User Data Rate: 1,024,000 bps
 In-Band Rate: 19,200 bps
 Control Ratio: 1 to 7

Aggregate data rate = 1,024,000 + 19,200 + (19,200/7) or approximately 1,045,942 (actually 1045974).

This gives an overhead ratio of $1,045,974/1,024,000 = 1.021$

In addition, another constraint changes the actual Aggregate Data Rate. The user data slot size is limited to 2,500 bits. Because of this, the modem increases the in-band rate to reduce the user data slot size. This only happens at higher user data rates.

NOTE: The Maximum In-Band rate is 115200. The Async interface Rate must be equal or greater in value.

3.14.3 Overhead Rate Comparison

The SCC Overhead Ratio varies depending on the User Data Rate, the In-Band Rate, and the Control Ratio. This gives SCC the advantage of lower overhead rates when compared to IBS, which has a fixed overhead ratio of 16/15 or 1.067. The following table gives some examples of SCC overhead rates for different user data and control ratios.

User Data Rate	In-Band Rate	Control Ratio	Aggregate Data Rate	Overhead Ratio
512,000	19,200	1/7	533,974	1.043
1,024,000	19,200	1/7	1,045,974	1.021
2,048,000	19,200	1/7	2,069,951	1.011
3,072,000	19,200	1/7	3,093,943	1.007
4,096,000	19,200	1/7	4,117,951	1.005
6,312,000	19,200	1/7	6,337,248	1.004
6,312,000	19,200	1/3	6,337,606	1.004
6,312,000	19,200	1/1	6,350,418	1.006

3.14.4 Actual Overhead Rate Calculation

The following is the actual calculation the modem does to calculate the overhead ratio:

1. The modem calculates the minimum in-band rate to limit the size of the user data slots to 2,500 bits (the result is truncated to an integer).

$$\text{Minimum In-Band} = (\text{User Data Rate} * \text{Control Ratio}) / ((\text{Control Ratio} + 1) * 250)$$

2. Using the bigger of Minimum In-Band or the selected In-Band, the modem calculates the number of bits for each user data slot (result is truncated to an integer).

$$\text{Slot Bits} = (\text{User Data Rate} * (\text{Control Ratio} * 10)) / (\text{In-band Rate} * (\text{Control Ratio} + 1))$$

Note: Slot bits of 0 are invalid.

The actual ratio the modem uses is:

$$\text{Actual Ratio} = (\text{Slot Bits} + 10) / \text{Slot Bits}$$

Example 1:

User Data Rate: 1,024,000 bps
 In-Band Rate: 19,200 bps
 Control Ratio: 1 to 7

Minimum In-Band = $(1,024,000 * 7) / ((7 + 1) * 250) = 3,584$ (*less than In-Band Rate*)

Slot Bits = $(1,024,000 * (7 * 10)) / (19,200 * (7 + 1)) = 466$

Actual Ratio = $(466 + 10) / 466 = 1.021$

Example 2:

User Data Rate: 6,312,000 bps
 In-Band Rate: 19,200 bps
 Control Ratio: 1 to 7

3.14.5 SCC Overhead Channel Setup

1. Set the Framing Mode (located under Mod and Demod Data Menus) to SCC. After doing this, two new menus will appear to the right of the Framing Menu, for both the Mod and Demod. The new menus will be:

SCC CTL RATIO
SCC INBAND RATE

2. Set the desired SCC control ratio:

SCC CTL RATIO {1/1, 1/2, 1/3, 1/4, 1/5, 1/6, 1/7}

This allows the user to simulate the framing used by the Satellite Control Channel Option (Pass-Thru Mode only). The SCC CTL RATIO is the ratio of overhead in-band data to synchronizing words.

3. Set the desired SCC in-band rate:

SCC INBAND RATE {300 to 115200}

This allows the user to request the rate of in-band data for the overhead channel. This sets the overhead amount only. The actual amount of data that can be passed through the overhead channel will be set under "ES Baud Rate" (see Step 6 below).

4. Under the Interface > General menus, locate the TX ASYNC MODE (menu).

5. Under the TX ASYNC MODE Menu, set the desired ES Interface type:

ES INTERFACE {RS-232, RS-485}

This allows the user to select the interface type.

6. Under TX ASYNC MODE Menu, set the desired baud rate for the ASYNC Port (J17). This will be the baud rate that will pass through the overhead channel:

ES BAUD RATE {150 - 115200}

This allows the user to select the baud rate of the ASYNC port (J17) in SCC Mode.

7. Under TX ASYNC MODE Menu, set the desired ES BITS/CHAR:

ES BITS/CHAR {7,8}

This allows the user to choose between 7 or 8 bits of data.

8. Repeat Steps 4 through 7 under the RX ASYNC MODE (menu)

9. The physical connection to the overhead channel will be the DB-9 Female Port labeled ASYNC (J17).

SCC Overhead Chart Examples (Viterbi 3/4 w/V.35 Scrambler)			
Modem Data Rate Kbps	SCC Control Channel Rate	In-Band Overhead Rate Setting	Symbol Rate
9.6	1/1	300	6800
9.6	1/2	300	6700
9.6	1/3	300	6667
9.6	1/4	300	6650
9.6	1/5	300	6641
9.6	1/6	300	6634
9.6	1/7	300	6629
9.6	1/1	9600	19200
9.6	1/2	9600	17067
9.6	1/3	9600	15543
9.6	1/4	9600	14400
9.6	1/5	9600	14400
9.6	1/6	9600	14400
9.6	1/7	9600	14400
512	1/1	9600	354165
512	1/2	9600	350948
512	1/3	9600	349867
512	1/4	9600	349346
512	1/5	9600	349201
512	1/6	9600	348802
512	1/7	9600	348658

3.15 DoubleTalk Carrier-in-Carrier Option



*BEFORE ATTEMPTING TO COMMISSION A SATELLITE LINK USING CARRIER-IN-CARRIER, THE USER **MUST** ENSURE THAT THE LINK IS ROBUST ENOUGH FOR NORMAL OPERATION. ONLY WHEN THIS HAS BEEN DONE – AND ALL SYSTEM ISSUES (E.G., ANTENNA-POINTING, CABLING, TERRESTRIAL INTERFERENCE, SATELLITE INTERFERENCE, ETC.) HAVE BEEN RESOLVED – SHOULD THE USER ATTEMPT THE USE OF CARRIER-IN-CARRIER.*

Space segment costs are typically the most significant operating expense for any satellite-based service, having a direct impact on the viability and profitability of the service. For a satellite transponder that has finite resources in terms of bandwidth and power, the leasing costs are determined by bandwidth and power used. Therefore, a satellite circuit should be designed for optimal utilization to use a similar share of transponder bandwidth and power.

The traditional approach to balancing a satellite circuit – once the satellite and earth station parameters are fixed – involves trade-off between modulation and coding. A lower order modulation requires less transponder power while using more bandwidth; conversely, higher order modulation reduces required bandwidth, albeit at a significant increase in power.

Comtech EF Data has added a new dimension to satellite communication optimization: DoubleTalk Carrier-in-Carrier.

3.15.1 What is DoubleTalk Carrier-in-Carrier?

The Radyne DMD20 DoubleTalk Carrier-in-Carrier option utilizes a patented (US 6,859,641) signal processing algorithm developed by Applied Signal Technology, Inc. that allows both the forward and reverse carriers of a full duplex link to share the same segment of transponder bandwidth, using patented “Adaptive Cancellation.” Applied Signal uses the term DoubleTalk™, and Comtech EF Data refers to it as DoubleTalk Carrier-in-Carrier (CnC).

CnC was first introduced in Comtech EF Data products in the CDM-Qx Satellite Modem and, more recently, in the CLO-10 Link Optimizer.

The implementation of DoubleTalk Carrier-in-Carrier in the Radyne DMD20 has been further refined, and some of the limitations that existed in the CDM-Qx implementation have been overcome.

This innovative technology provides a significant improvement in bandwidth and power utilization, beyond what is possible with FEC and modulation alone, allowing users to achieve unprecedented savings. When combined with advanced modulation and FEC, it allows for multi-dimensional optimization:

- Reduced operating expense (OPEX) – e.g., Occupied Bandwidth & Transponder Power;
- Reduced capital expenditure (CAPEX) – e.g., Block Up Converter/High-Power Amplifier (BUC/HPA) size and/or antenna size;
- Increased throughput without using additional transponder resources;
- Increased link availability (margin) without using additional transponder resources;
- A combination of any of the above to meet different objectives.

Summary: When carriers share common bandwidth, up to 50% savings in transponder utilization is possible.

3.15.2 Application Requirements

The following conditions are necessary in order to operate DoubleTalk Carrier-in-Carrier:

- Link must be full duplex.
- A Radyne DMD20 must be used at the end of the link where the cancellation needs to take place.
- The transponder is operated as Loopback. That is, each end of the link must be able to see a copy of its own signal in the return (downlink) path from the satellite. The looped back signal is then subtracted which leaves the signal from the distant end of the link. **DoubleTalk Carrier-in-Carrier cannot be used in spot beam systems.**
- The transponder needs to be “bent-pipe” – meaning no on-board processing, demodulation, regeneration can be employed. Demodulation/remodulation does not preserve the linear combination of the forward and return signals and the resulting reconstituted waveform prevents recovery of the original constituent signals.

Figure 3-10 shows a simplified conceptual block diagram of CnC processing. The two ends of the link are denoted **A** and **B** and the uplink and downlink are shown.

This performance is achieved through advanced signal processing algorithms that provide superior cancellation while tracking and compensating for the following common link impairments:

- 1) **Time varying delay:** In addition to the static delays of the electronics and the round-trip delay associated with propagation to the satellite and back, there is a time-varying component due to movement of the satellite. The CnC module tracks and compensates for this variation.
- 2) **Frequency offset and drift:** Common sources are satellite Doppler shift, up and down converter frequency uncertainties, and other drift associated with the electronics in the Radyne DMD20 itself. The CnC module tracks and compensates for this frequency offset and drift.
- 3) **Atmospheric effects:** Fading and scintillation can affect amplitude, phase, and spectral composition of the signal and the degree to which it correlates with the original signal. The CnC module tracks and compensates for these atmospheric related impairments.

- 4) **Link Asymmetries:** Various asymmetries in the forward and return link can produce differences in the relative power of the two received signal components. These can be both deterministic (static) or random (and time varying). An example of the former would be the differences resulting from antenna size/gain variations between the two ends of the link. An example of the latter would be transient power differences due to different levels of atmospheric fading in the uplinks. CnC compensates for the asymmetries, up to a certain extent.

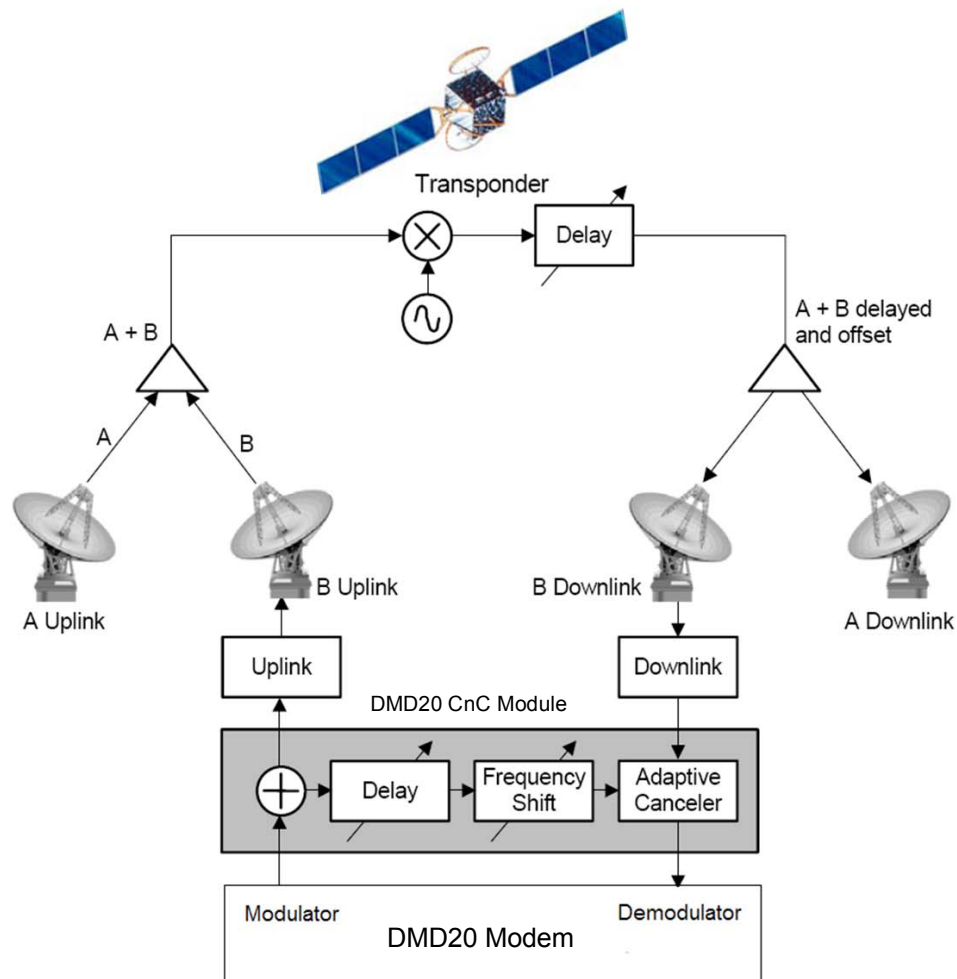

Figure 3-10. Conceptual Block Diagram

In a number of ways, CnC carriers behave similar to conventional carriers in satellite links. They are both exposed to adjacent carriers, cross-polarization and rain fade, and exhibit impairments when any of these become too great. In addition, CnC operates in an environment where:

- Carriers intentionally occupy the same spectral slot;
- Performance depends upon desired and co-located interfering carrier.

3.15.3 Operational Recommendations

The rules for CnC operation are summarized below:

- Both earth stations share the same footprint so each sees both carriers;
- CnC carriers are operated in pairs;
- One outbound with multiple return carriers is not allowed;
- Asymmetric data rates are allowed (see Section 3.15.15 for CnC specifications);
- The ratio of power spectral density is normally less than 11 dB;
- CnC operates with *modems* – **not** *modulators only* or *demodulators only*.

In addition, to minimize 'false' acquisition, observe the following:

- Use of IESS-315 V.35 Scrambler is highly recommended;
- Keep the search delay range as narrow as possible – once the modem has reported the search delay, narrow the search delay range to the nominal reported value +/- 5 ms – for example, if the modem reported delay is 245 ms, narrow the search range to say 240 – 250 ms.
- Use external data source (e.g. Firebird) or internal BER tester when testing Carrier-in-Carrier performance.
- To prevent self-locking in case the desired carrier is lost, it is recommended that the two carriers have some configuration difference – for example, use different settings for Spectrum Inversion.

3.15.4 System Functionality and Operational Considerations

Figure 3-11 illustrates a conventional, full duplex satellite link where two carriers are placed in non-overlapping channels.

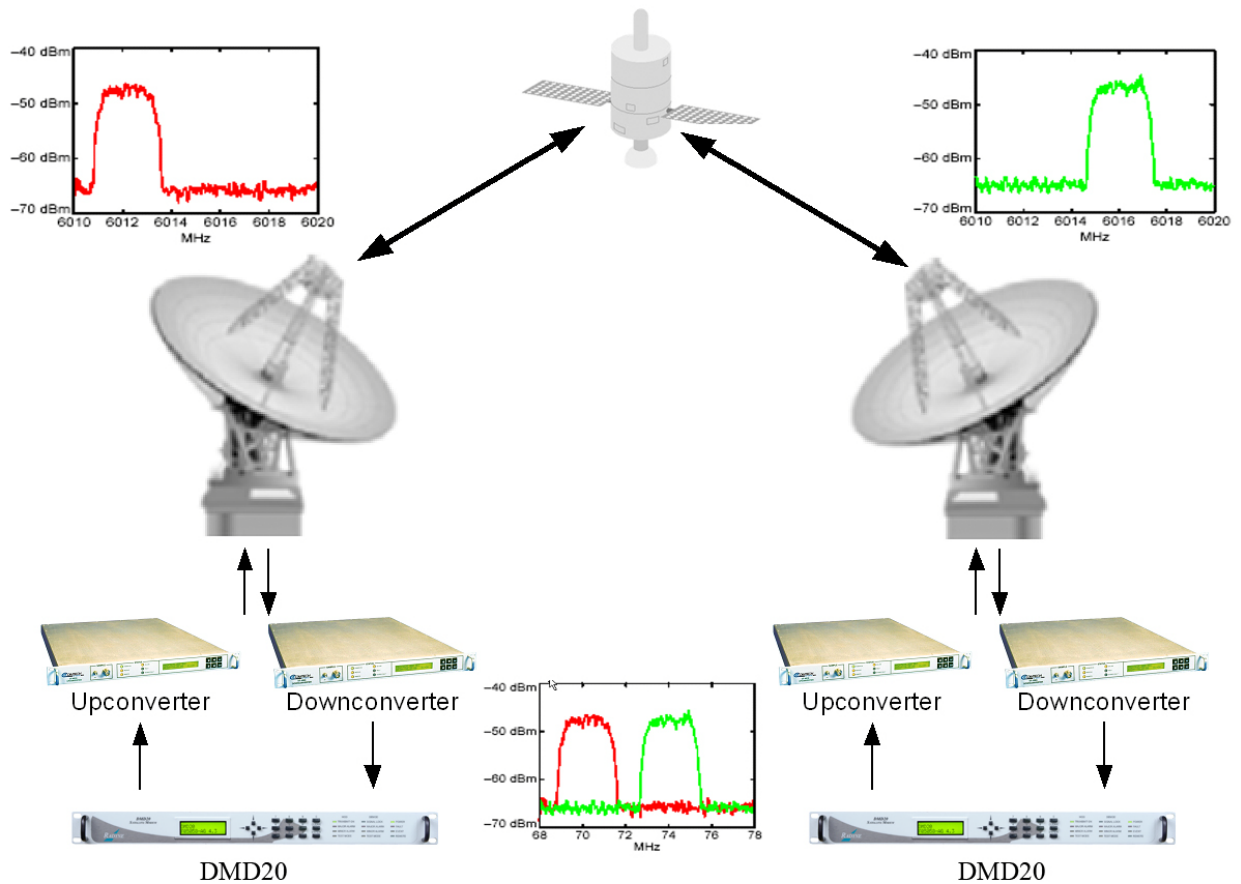

Figure 3-11. Conventional FDMA Link

Figure 3-12 shows the same link using the Radyne DMD20 equipped with the DoubleTalk Carrier-in-Carrier option. Note that now only 50% of the bandwidth is being used, as now both carriers are occupying the same bandwidth.

The transponder downlinks the composite signal containing both carriers on the same band to the Radyne DMD20 which then translates the signal to near baseband where it can be filtered (decimated) and then processed as a complex envelope signal. The Radyne DMD20 then suppresses the version of the near end carrier on the downlink side and then passes the desired carrier to the demodulator for normal processing.

To further illustrate, as shown in **Figure 3-13**, without DoubleTalk Carrier-in-Carrier, the two carriers in a typical full duplex satellite link are adjacent to each other. With DoubleTalk Carrier-in-Carrier, only the composite signal is visible when observed on a spectrum analyzer. Carrier 1 and Carrier 2, shown here for reference only, are overlapping, thus sharing the same spectrum.

The Radyne DMD20 CnC module operates on the near-zero signal before the demodulator, and is waveform agnostic. This means that no prior knowledge of the underlying modulation, FEC, or any other waveform specific parameter is required in order to perform the signal suppression operation. The only caveat to this is that the waveform must be *sufficiently random*.

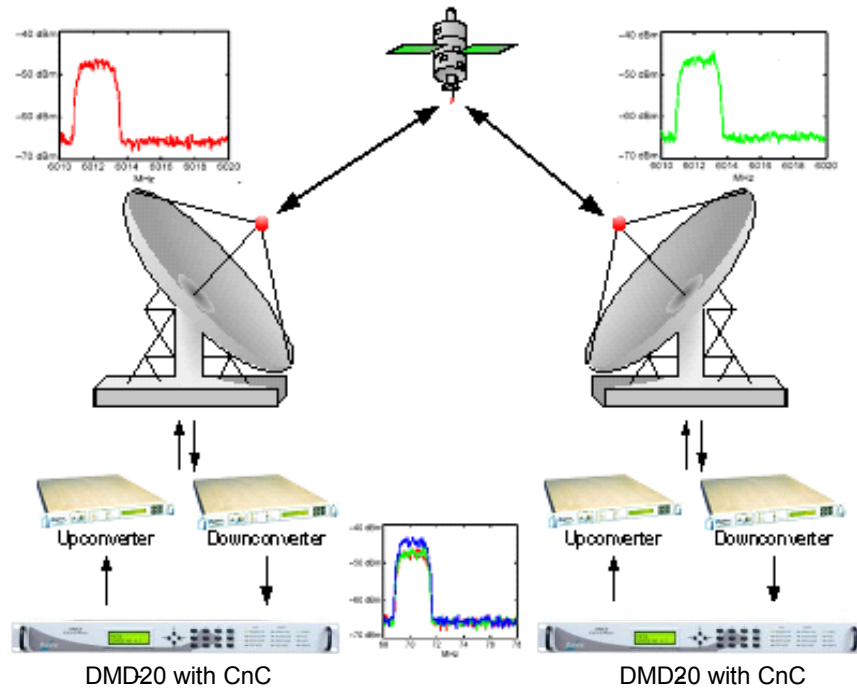

Figure 3-12. Same Link Using Radyne DMD20 and DoubleTalk Carrier-in-Carrier

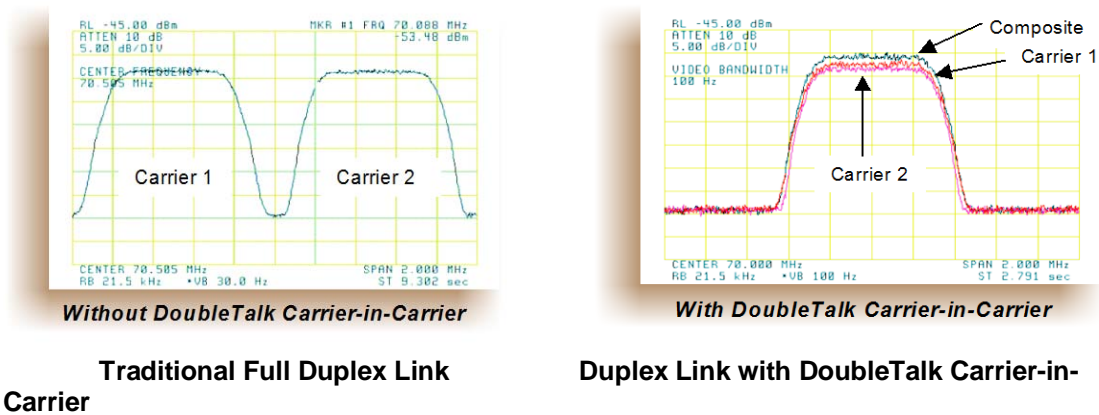

Figure 3-13. Duplex Link Optimization

Because acquiring the delay and frequency offset of the interfering carrier is fundamentally a correlation operation, anything deterministic in the interfering carrier (within the correlation window of the algorithm) will potentially produce false correlation peaks and result in incorrect delays and/or frequency. Normally, this is not a problem, since energy dispersal techniques are utilized in the vast majority of commercial and military modems. However, it is something that must be kept in mind when troubleshooting a system that utilizes the DoubleTalk Carrier-in-Carrier technique for signal suppression.

One possible way to mitigate false peaks is to narrow the correlation window. For example, if the delay is known to be around 240ms, set the minimum search delay to 230ms and the maximum search delay to 250ms.

As all advances in modem technologies – including advanced modulation and FEC techniques – approach their theoretical limits of power and bandwidth efficiencies, DoubleTalk Carrier-in-Carrier allows satellite users to achieve spectral efficiencies (bps/Hz) that cannot be achieved with modulation and FEC alone. **Table 3-4** illustrates how DoubleTalk Carrier-in-Carrier, when used with 16-QAM, approaches the bandwidth efficiency of 256-QAM (8bps/Hz).

Table 3-4. Spectral Efficiency using DoubleTalk Carrier-in-Carrier

Modulation and Code Rate	Spectral Efficiency (bps/Hz)	
	Traditional SCPC	Carrier-in-Carrier
BPSK 1/2	0.50	1.00
QPSK 1/2	1.00	2.00
QPSK 2/3	1.33	2.67
QPSK 3/4	1.50	3.00
QPSK 7/8	1.75	3.50
8-QAM 2/3	2.00	4.00
8-QAM 3/4	2.25	4.50
8-QAM 7/8	2.63	5.25
16-QAM 3/4	3.00	6.00
16-QAM 7/8	3.50	7.00

As shown here, DoubleTalk Carrier-in-Carrier allows equivalent spectral efficiency using a lower order modulation and/or FEC Code Rate; CAPEX is therefore reduced by allowing the use of a smaller BUC/HPA and/or antenna. And, as DoubleTalk Carrier-in-Carrier can be used to save transponder bandwidth and/or transponder power, it can be successfully deployed in bandwidth-limited as well as power-limited scenarios.

3.15.5 DoubleTalk Carrier-in-Carrier Cancellation Process

The state-of-the-art signal processing technology employed via DoubleTalk Carrier-in-Carrier continually estimates and tracks all parametric differences between the local uplink signal and its image within the downlink. Through advanced adaptive filtering and phase locked loop implementations, it dynamically compensates for these differences by appropriately adjusting the delay, frequency, phase and amplitude of the sampled uplink signal, resulting in excellent cancellation performance.

When a full duplex satellite connection is established between two sites, separate satellite channels are allocated for each direction. If both directions transmitted on the same channel, each side would normally find it impossible to extract the desired signal from the aggregate due to interference originating from its local modulator. However since this interference is produced locally, it is possible to estimate and remove its influence prior to demodulation of the data transmitted from the remote location.

For the DoubleTalk Carrier-in-Carrier cancellation, it is necessary to provide each demodulator with a copy of its local modulator's output.

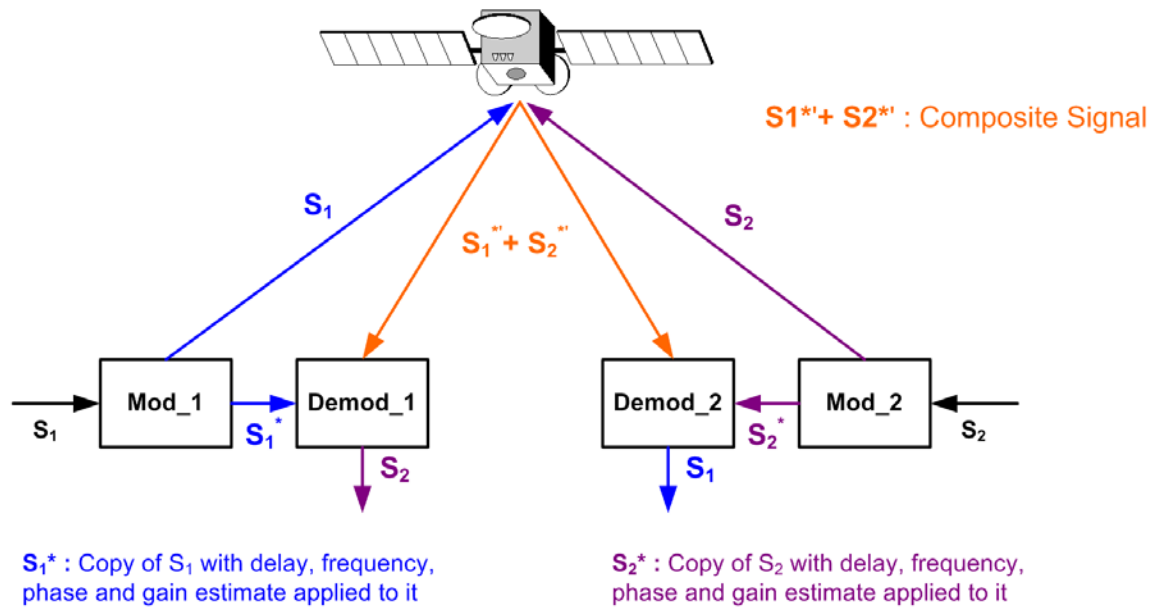

Figure 3-14. DoubleTalk Carrier-in-Carrier Signals

Referring to Figure 3-14: Modem 1 and Modem 2 transmit signals S_1 and S_2 respectively. The satellite receives, translates, and retransmits the composite signal. The downlink signals S_1^* and S_2^* , received at Modem 1 and Modem 2 differ from the transmit signals primarily in terms of phase, frequency, and delay offsets.

Referring to Figure 3-15: For round trip delay estimation, a search algorithm is utilized that correlates the received satellite signal to a stored copy of the local modulator's transmitted signal. The interference cancellation algorithm uses the composite signal and the local copy of S_1 to estimate the necessary parameters of scaling (complex gain/phase), delay offset and frequency offset. The algorithm continuously tracks changes in these parameters as they are generally time-varying in a satellite link.

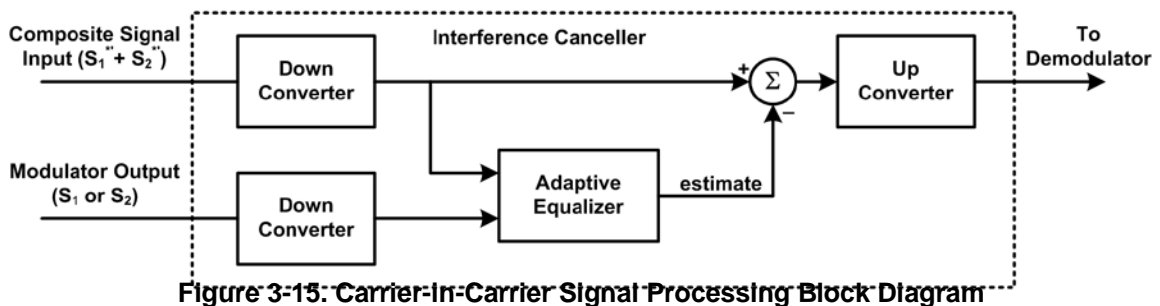

Figure 3-15: Carrier-in-Carrier Signal Processing Block Diagram

The resulting estimate of the unwanted interfering signal is then subtracted from the composite signal. In practical applications, the estimate of the unwanted signal can be extremely accurate. Unwanted interfering signal suppression of 30 dB or more has been achieved in commercial products with minimal degradation of the demodulator performance.

3.15.6 Margin Requirements

Typical interfering signal cancellation is 28 to 35 dB (depending on the product). The residual interfering signal appears as noise causing a slight degradation of the E_b/N_o . To compensate for the residual noise, a small amount of additional link margin is required to maintain the BER. Margin requirements depend on the product, modulation and power ratios:

For the Radyne DMD20, the additional margin requirements are as follows:

Modulation	Nominal Margin*
BPSK	0.3 dB
QPSK/OQPSK	0.3 dB
8-PSK	0.5 dB
8-QAM	0.4 dB
16-QAM	0.6 dB

* Equal power and equal symbol rate for the interfering carrier and the desired carrier, i.e., 0 dB PSD ratio. Measured at IF with AWGN, +10 dBc Adjacent Carriers, 1.3 spacing.

3.15.7 Carrier-in-Carrier Latency

Carrier-in-Carrier has no measurable impact on circuit latency.

3.15.8 Carrier-in-Carrier Link Design

Carrier-in-Carrier link design involves finding the FEC and modulation combination that provides optimal bandwidth utilization. Just like conventional link design, it is an iterative process that involves trying different FEC and modulation combinations with Carrier-in-Carrier until an optimal combination is found.

For optimal Carrier-in-Carrier performance, it is recommended that the two carriers have similar symbol rate and power. This can be achieved by selecting appropriate MODCODs as shown in following sections.

3.15.8.1 Symmetric Data Rate Link

Consider the following example:

Satellite & Transponder	Galaxy 18 @ 123° W, 13K/13K
Earth Station 1	Phoenix, AZ – 4.6 m
Earth Station 2	Phoenix, AZ – 2.4 m
Data Rate	512 kbps / 512 kbps

The traditional link was based on QPSK TPC 3/4 and required 0.96 MHz of leased BW. The LST summary for the traditional link is as follows:

Link Analysis Description:			
MultiCarrier Txpdr Lease	Link 1	Link 2	
Number of links: <input type="text" value="2"/>			
Modulation	QPSK	QPSK	
Information Rate	512.0	512.0	kbit/s
FEC Code Rate	.7500	.7500	
R-S Code Rate	N/A	N/A	
Clear Sky Eb/No Available	9.3	8.7	dB
Number of Assigned Carriers	1	1	
Transmit ES Code	4_6M	2_4M	
Transmit ES Size	4.6	2.4	m
Receive ES Code	2_4M	4_6M	
Receive ES Size	2.4	4.6	m
Receive ES G/T	24.5	29.0	dB/K

Total Leased Resource Usage:			
LST calculated			
(MultiCarrier Txpdr Lease)			
Total EIRP utilized	20.1 dBW		
Total EIRP available	20.9 dBW		
Margin (available-utilized)	.9 dB		
		Total BW allocated	.9557 MHz
		Total BW PEB	.8208 MHz
		Total BW utilized	.9557 MHz
		Total BW available	1.0000 MHz
		Margin (available-utilized)	.0443 MHz

Allocated BW = 0.9557 MHz
PEB = 0.8208 MHz
Leased BW = 0.9557 MHz

Carrier-in-Carrier link design involved trying different Modulation & FEC Code Rates to find the optimal combination:

- 8-QAM, LDPC 2/3 with Carrier-in-Carrier
- QPSK, LDPC 3/4 with Carrier-in-Carrier
- QPSK, LDPC 2/3 with Carrier-in-Carrier
- QPSK, LDPC 1/2 with Carrier-in-Carrier

Link parameters and LST summary for QPSK, LDPC 2/3 with Carrier-in-Carrier is as follows:

Includes IF-RF Margin and CnC Margin

Link Analysis Description:			
	Link 1	Link 2	
MultiCarrier Txpdr Lease			
Number of links	2		
Modulation	QPSK	QPSK	
Information Rate	512.0	512.0	kbit/s
FEC Code Rate	.6670	.6670	
R-S Code Rate	N/A	N/A	
Clear Sky Eb/No Available	7.9	7.3	dB
Number of Assigned Carriers	1	1	
Transmit ES Code	4_6M	2_4M	
Transmit ES Size	4.6	2.4	m
Receive ES Code	2_4M	4_6M	
Receive ES Size	2.4	4.6	m
Receive ES G/T	24.5	29.0	dB/K

Total Leased Resource Usage:			
LST calculated		Total BW allocated	1.0747 MHz
(MultiCarrier Tx pdr Lease)		Total BW PEB	.5777 MHz
Total EIRP utilized	18.6 dBW	Total BW utilized	1.0747 MHz
Total EIRP available	21.4 dBW	Total BW available	1.1000 MHz
Margin (available-utilized)	2.8 dB	Margin (available-utilized)	.0253 MHz

CnC Allocated BW = 1.0747 / 2 = 0.53735 MHz
CnC PEB = 0.5777 MHz
CnC Leased BW = 0.5777 MHz

The link budget summary for the different MODCOD combinations is as follows:

S. No.	Modulation & FEC	Allocated BW (MHz)	PEB (MHz)	Leased BW (MHz)	Savings Compared to Original	PSD Ratio (dB)
1	8-QAM, LDPC 2/3	0.3584	1.1468	1.1468	-20%	2.1
2	QPSK, LDPC 3/4	0.47785	0.6734	0.6734	30%	2.1
3	QPSK, LDPC 2/3	0.53735	0.5777	0.5777	40%	2.1
4	QPSK, LDPC 1/2	0.7168	0.5184	0.7168	25%	2.1

Based on this analysis, QPSK, LDPC 2/3 with Carrier-in-Carrier provides the maximum savings of 40%.

In addition to 40% reduction in Leased Bandwidth, using Carrier-in-Carrier also reduced the required HPA Power by almost 40%:

HPA Power	Traditional Link (QPSK, TPC 3/4)	CnC Link (QPSK, LDPC 2/3)	HPA Power Reduction
HPA @ 4.6 m	0.7 W	0.5 W	40%
HPA @ 2.4 m	1.5 W	1.1 W	36%

3.15.8.2 Asymmetric Data Rate Link

As occupied (or allocated) bandwidth of a Carrier-in-Carrier circuit is dictated by the larger of the two carriers, it is strongly recommended that the smaller carrier be spread as much as possible using a lower order modulation and/or FEC, while meeting the PSD ratio spec. Spreading the smaller carrier using a lower order modulation has multiple benefits:

- Lower order modulation is always more robust;
- Lower order modulation uses less transponder power – this reduces total transponder, and increases available link margin;
- Lower order modulation uses less transmit power on the ground – this can significantly reduce the BUC/SSPA size by not only reducing the transmit EIRP, but also reducing the BUC/SSPA backoff

Consider the following example:

Satellite & Transponder	IS-901 @ 342° W, 22/22 (EH/EH)
Earth Station 1	Africa – 4.5 m
Earth Station 2	Africa – 3.0 m
Data Rate	3000 Mbps / 1000 Mbps

While the traditional link was based on QPSK, TPC 3/4 and required 3.9 MHz of leased bandwidth, the Carrier-in-Carrier link was based on QPSK, LDPC 3/4 and QPSK, LDPC 1/2 and required 2.8 MHz of leased bandwidth.

The savings summary is as follows:

Item	Original Link			With Carrier-in-Carrier and LDPC			Savings
	Hub to Remote	Remote To Hub	Total	Hub to Remote	Remote to Hub	Total	
Data Rate (kbps)	3000	1000		3000	1000		
Modulation	QPSK	QPSK		QPSK	QPSK		
FEC	TPC 3/4	TPC 3/4		LDPC 3/4	LDPC 1/2		
Occupied BW (MHz)	2.8	0.9	3.7	2.8	1.4	2.8	
Power Eq. BW (MHz)	3.3	0.6	3.9	2.5	0.3	2.8	
Leased BW (MHz)			3.9			2.8	27.5%
Hub HPA (W)	26.0			20.3			22%
Remote HPA (W)	10.6			6.4			40%

If this link was designed using QPSK, LDPC 3/4 in both directions, it would have required:

Occupied BW	2.8 MHz	
Power Eq. BW	3.0 MHz	7.2% increase in Power Eq. BW
Leased BW	3.0 MHz	7.2% increase in Leased BW
Hub HPA	20.3 W	
Remote HPA	8.3 W	30% increase in Remote power

3.15.8.3 Power Limited Links

Carrier-in-Carrier can provide substantial savings even when the original link is power limited. Spreading the carrier by using a lower modulation and/or FEC along with latest FEC such as VersaFEC can substantially reduce the total power which can then be traded with bandwidth using Carrier-in-Carrier. The concept is illustrated with the following examples:

The conventional link is using 8-PSK, TPC 3/4:

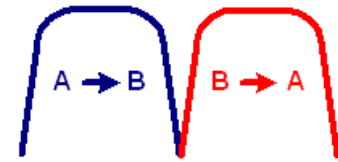

Switching to VersaFEC and using a lower order modulation – e.g., QPSK, VersaFEC 0.803 increases the total occupied bandwidth, while reducing the total power equivalent bandwidth:

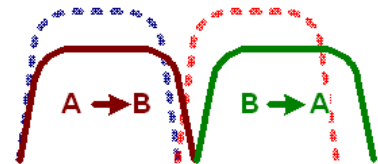

Now using DoubleTalk Carrier-in-Carrier, the second QPSK, VersaFEC 0.803 carrier can be moved over the first carrier – thereby significantly reducing the total occupied bandwidth and total power equivalent bandwidth when compared to the original side-by-side 8PSK, TPC 3/4 carriers:

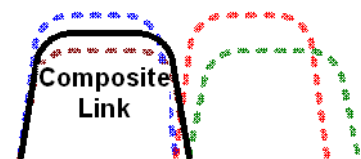

To continue, consider this example:

Satellite & Transponder	IS-901 @ 342° W, 22/22 (EH/EH)
Earth Station 1	Africa – 9.2 m
Earth Station 2	Africa – 4.5 m
Data Rate	2.048 Mbps / 2.048 Mbps

Whereas the original link used 8-PSK TPC 3/4, the Carrier-in-Carrier link used QPSK VersaFEC 0.803. The savings summary is as follows:

Item	Original Link			With Carrier-in-Carrier and VersaFEC			Savings
	Hub to Remote	Remote To Hub	Total	Hub to Remote	Remote to Hub	Total	
Data Rate (kbps)	2048	2048		2048	2048		
Modulation	8-PSK	8-PSK		QPSK	QPSK		
FEC	TPC 3/4	TPC 3/4		0.803	0.803		
Occupied BW (MHz)	1.3	1.3	2.6	1.8	1.8	1.8	
Power Eq. BW (MHz)	2.2	1.0	3.2	1.1	0.5	1.6	
Leased BW (MHz)			3.2			1.8	44%
Hub HPA (W)	5.0			2.0			60%
Remote HPA (W)	11.6			4.7			60%

Note: 1 dB HPA BO for QPSK, 2 dB HPA BO for 8-PSK, 1 dB Feed Loss.

Using Carrier-in-Carrier and VersaFEC reduced the leased bandwidth by almost 44% and HPA power by 60%

3.15.9 Carrier-in-Carrier Commissioning and Deployment

Prior to commissioning a Carrier-in-Carrier link, it is critical that the link is fully tested in non Carrier-in-Carrier mode and all system issues including external interference, antenna pointing, cabling, SSPA backoff are resolved. Only after the link is robust, should the user attempt turning on Carrier-in-Carrier.

The following procedure is recommended for Carrier-in-Carrier commissioning and deployment:

Step	Procedure
1	<p>Turn ON the carrier at Site A. Carrier from Site B is OFF. CnC function is OFF at both sites.</p> <ul style="list-style-type: none"> ➤ Using a spectrum analyzer, measure Co+No/No at the input to the modem at Site A. ➤ Using a spectrum analyzer, measure Co+No/No at the input to the modem at Site B. ➤ Measure/record Eb/No at Site B. Make sure there is sufficient margin to account for CnC. ➤ Measure/record Receive Signal Level (RSL) at Site B.
2	<p>Turn OFF the carrier at Site A. Turn ON the carrier at Site B. CnC function is OFF at both sites.</p> <ul style="list-style-type: none"> ➤ Using a spectrum analyzer, measure Co+No/No at the input to the modem at Site A. ➤ Using a spectrum analyzer, measure Co+No/No at the input to the modem at Site B. ➤ Measure/record Eb/No at Site A. Make sure there is sufficient margin to account for CnC. ➤ Measure/record RSL at Site B.
3	<p>Using Co+No/No readings calculate PSD ratio at Site A and Site B. If it is not within specification, make necessary adjustments to bring it within specification and repeat measurements in Step (1) and (2).</p> <ul style="list-style-type: none"> ➤ Also verify that the RSL is within spec.
4	<p>Now without changing the transmit power levels, turn ON both the carriers (on the same frequency) and turn CnC ON.</p> <ul style="list-style-type: none"> ➤ Measure/record Eb/No at Site A and B. ➤ Measure/record RSL at Site A and B. ➤ Now compare Eb/No in presence of 2 over lapping carriers with CnC with Eb/No when only 1 carrier was ON. Eb/No variation should be within spec for that modulation, FEC and PSD ratio.
5	<p>The test can be repeated for different PSD ratio and Eb/No.</p>

3.15.10 Validating Carrier-in-Carrier Performance

Carrier-in-Carrier performance can be easily validated by verifying that E_b/N_0 degradation due to Carrier-in-Carrier is within published specification for the observed Power Spectral Density Ratio.

The following procedure is recommended for validating Carrier-in-Carrier performance:

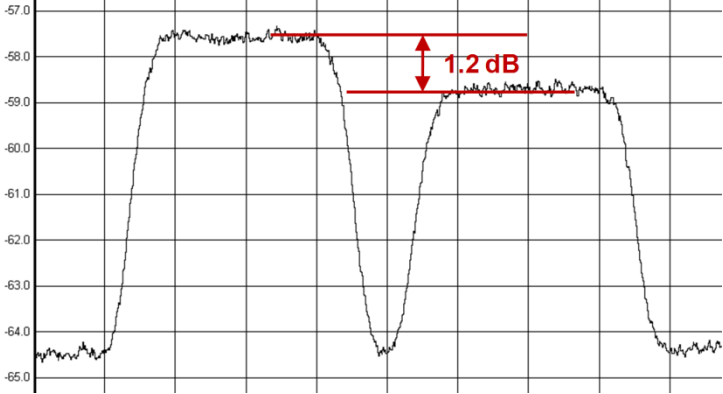
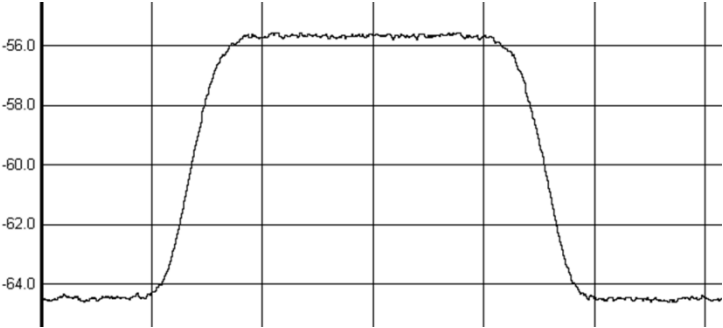
Step	Procedure
1	<p>Setup a conventional side-by-side link of the desired E_b/N_0:</p> <ul style="list-style-type: none"> ➤ Carrier-in-Carrier should be OFF. ➤ Record the E_b/N_0 as displayed by the Modems. ➤ Observe the 2 carriers on a spectrum analyzer and record the PSD ratio. <p>Example Link:</p> <ul style="list-style-type: none"> • Full duplex 512 kbps, QPSK, LDPC 2/3 circuit between 4.6 m and 2.4 m antennas • Recorded E_b/N_0 = 2.6 dB (at both modems) • PSD Ratio = 1.2 dB (measured at larger Antenna) 
2	<p>Now relocate one of the carriers on top of the other carrier:</p> <ul style="list-style-type: none"> ➤ Enable Carrier-in-Carrier. ➤ Record the E_b/N_0 as displayed by the Modems.
3	<p>Calculate change in E_b/N_0 and verify against specification.</p> <p>Example Link:</p> <ul style="list-style-type: none"> • Recorded E_b/N_0 = 2.4 dB • Change in E_b/N_0 = 0.2 dB • E_b/N_0 Degradation (Spec.) at 1.2 dB PSD = 0.3 dB • Modem performance is within spec. 

3.15.11 Operational References

3.15.12 Carrier-in-Carrier Link Budget Calculation

The following steps are required for calculating the link budget for a Carrier-in-Carrier Link:

1. Calculate the link budget for both carriers in the duplex link, with required CnC margin:

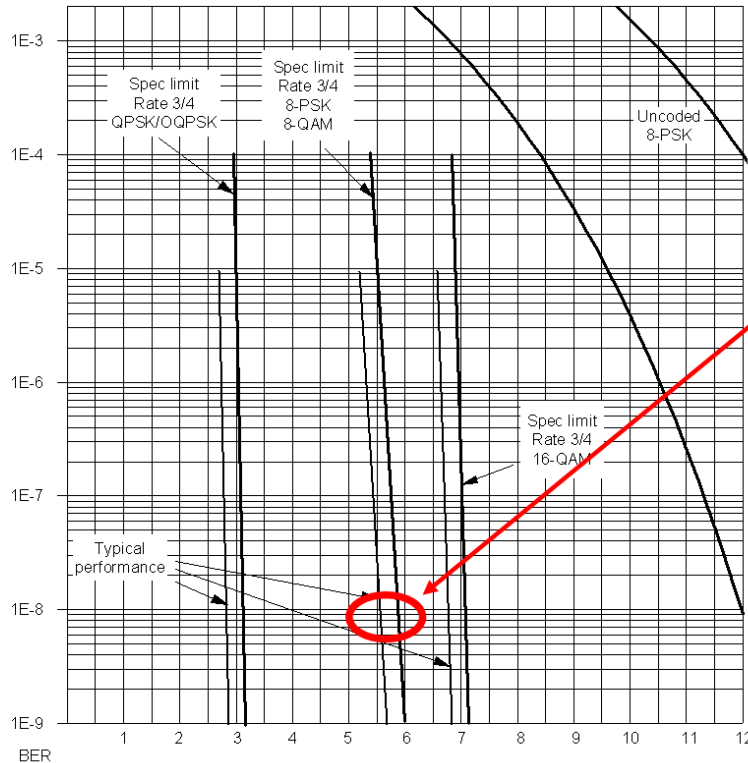

- Find the E_b/N_0 corresponding to the desired BER
- Add CnC Margin
- Add any other margin
- Use this compiled value as the Threshold E_b/N_0 for the link budget

2. Verify that the PDS ratio is within

spec for the Radyne DMD20.

3. Calculate the Allocated Bandwidth (BW) and Power Equivalent Bandwidth (PEB) for the duplex link:
 - $BW_{\text{Duplex Link}} = \text{Greater of } (BW_{\text{Carrier 1}}, BW_{\text{Carrier 2}})$
 - $PEB_{\text{Duplex Link}} = PEB_{\text{Carrier 1}} + PEB_{\text{Carrier 2}}$
 - $\text{Leased } BW_{\text{Duplex Link}} = \text{Greater of } (BW_{\text{Duplex Link}}, PEB_{\text{Duplex Link}})$
4. For an optimal link, the Leased Bandwidth and the Power Equivalent Bandwidth should be equal / nearly equal.
5. Repeat the link budget process by selecting different Modulation and FEC, until the BW and PEB is nearly balanced.

3.15.13 Estimating PSD Ratio

PSD can be estimated from a link budget using Downlink EIRP and Symbol Rate:

$$\text{PSD} = \text{Downlink EIRP} - 10 * \text{Log} (\text{Symbol Rate})$$

PSD Ratio Example:

Carrier	Downlink EIRP	Symbol Rate	Power Spectral Density
A to B	27 dBW	500 ksps	-29.99 dBW/Hz
B to A	24 dBW	375 ksps	-31.74 dBW/Hz

PSD Ratio (@ A) = -29.99 – (-31.74) = 1.75 dB

PSD Ratio (@ B) = 01.74 – (-29.99) = -1.75 dB

3.15.13.1 Estimating PSD Ratio from LST

Carrier Information	Link 1	Link 2	
Carrier Type	IPL	IPL	
Performance			BER
Modulation	8-Phase	8-Phase	
Eb/No Threshold	5.6	5.6	dB
C/N Threshold	8.6	8.6	dB
Center Frequency	6014.0	6014.0	MHz
Information Rate (IR)	4096.0	4096.0	kbit/s
Overhead (OH)	.0	.0	kbit/s
Data Rate (IR + OH)	4096.0	4096.0	kbit/s
FEC Code Rate	.6667	.6667	
R-S Code Rate	N/A	N/A	
Transmission Rate	6143.7	6143.7	kbit/s
Bandwidths and Margins			
Filter Rolloff Factor	.40	.40	
Allocated Bandwidth	2.8671	2.8671	MHz
Noise Bandwidth	2.0479	2.0479	MHz
Number of Assigned Carriers Per Link	1	1	

PSD Link 2
 $15.8 - 10 * \text{Log} (2.0479 * 1000000) = -47.3 \text{ dBW/Hz}$

PSD Ratio
 $\pm 1.0 \text{ dB}$

PSD Link 1
 $16.8 - 10 * \text{Log} (2.0479 * 1000000) = -46.3 \text{ dBW/Hz}$

Per Carrier UL & DL eirp (Cir-Sky)	Link 1	Link 2	
Transmit ES elevation angle	70.4	54.5	deg.
Uplink EIRP per carrier	58.7	57.0	dBW
Pathloss at uplink frequency	199.3	199.5	dB
Gain of 1 m2 antenna	37.1	37.1	dB
Per carrier FD @SC	-103.5	-105.4	dBW/m2
SC pattern advantage @ES	1.8	2.8	dB
Per carrier BE FD arriving @ SC	-101.7	-102.7	dBW/m2
Transponder BE SFD	-79.0	-79.0	dBW/m2
Per carrier input back-off	-22.7	-23.7	dB
Per carrier output back-off	-20.2	-21.2	dB
Transponder BE saturation EIRP	27.0	27.0	dBW
Downlink BE EIRP	16.8	15.8	dBW

3.15.13.2 Estimating PSD Ratio from Satmaster

Carrier A to B

Space Segment Utilization

Overall link availability	99.800
Information rate (inc overhead)	10.2400
Transmit rate	13.6533
Symbol rate	3.4133
Occupied bandwidth	4.2667
Noise bandwidth	66.30
Minimum allocated bandwidth required	4.2667
Allocated transponder bandwidth	4.2667
Percentage transponder bandwidth used	11.95
Used transponder power	22.57
Percentage transponder power used	7.20

Value	Units
99.800	%
10.2400	Mbps
13.6533	Mbps
3.4133	Mbaud
4.2667	MHz
66.30	dB.Hz
4.2667	MHz
4.2667	MHz
11.95	%
22.57	dBW
7.20	%

PSD Carrier A to B
 $= 22.57 - 10 * \text{Log}(3.4133 \times 10^6)$
 $= -42.76 \text{ dBW/Hz}$

PSD Carrier B to A
 -40.81 dBW/Hz

PSD Ratio
 $\pm 1.95 \text{ dB}$

Carrier B to A

Space Segment Utilization

Overall link availability	99.800
Information rate (inc overhead)	10.2400
Transmit rate	13.6533
Symbol rate	3.4133
Occupied bandwidth	4.2667
Noise bandwidth	66.30
Minimum allocated bandwidth required	4.2667
Allocated transponder bandwidth	4.2667
Percentage transponder bandwidth used	11.95
Used transponder power	24.52
Percentage transponder power used	8.96

Value	Units
99.800	%
10.2400	Mbps
13.6533	Mbps
3.4133	Mbaud
4.2667	MHz
66.30	dB.Hz
4.2667	MHz
4.2667	MHz
11.95	%
24.52	dBW
8.96	%

CnC Ratio
 $\pm 1.95 \text{ dB}$

3.15.13.3 Estimating PSD Ratio Using Spectrum Analyzer

PSD Ratio or CnC Ratio can also be estimated using a Spectrum Analyzer capable of integrating the signal power in a given bandwidth.

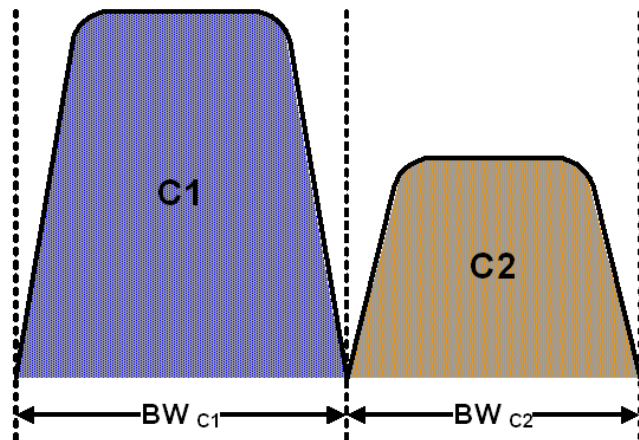

$$\text{CnC Ratio (in dBm)} = \text{Power}_{C1} \text{ (in dBm)} - \text{Power}_{C2} \text{ (in dBm)}$$

$$\begin{aligned} \text{PSD Ratio (in dB)} &= (\text{Power}_{C1} - 10 \log BW_{C1} \text{ (in Hz)}) - (\text{Power}_{C2} - 10 \log BW_{C2} \text{ (in Hz)}) \\ &= \text{CnC Ratio} - 10 \log (BW_{C1} / BW_{C2}) \end{aligned}$$

If the two carriers have same Symbol Rate / Bandwidth, then the CnC Ratio is same as the PSD Ratio.

3.15.14 DoubleTalk Carrier-in-Carrier Specifications

Operating Mode	Requires the two links to share a common carrier frequency (Outbound and Inbound symbol rates do not have to be equal)
Power Spectral Density Ratio and CnC Ratio	<p>BSPK/QPSK/8-PSK/8-QAM: -7 dB to +11 dB (ratio of power spectral density, outbound interferer to desired inbound)</p> <p>16-QAM: -7 dB to +7 dB (ratio of power spectral density, outbound interferer to desired inbound)</p> <p>Note: With asymmetric carriers the absolute power ratio (or CnC ratio) would be different, depending on the ratio of the symbol rates.</p> <p>Example:</p> <p>Outbound interferer = 1 Msymbols/sec Desired Inbound = 500 ksymbols/sec Ratio of power spectral density = +7 dB Absolute power ratio (CnC Ratio) = +7dB + (10 log Outbound/desired symbol rate) = +10 dB</p>
Maximum Symbol Rate Ratio	3:1 (TX:RX or RX:TX)
Inbound/Outbound frequency uncertainty	<p>Within the normal acquisition range of the demod, as follows:</p> <p>Below 32 ksymbols/sec: ± 1 to $\pm (R_s/2)$ kHz, where R_s = symbol rate in ksymbols/sec</p> <p>Between 32 and 389 ksymbols/sec: ± 1 up to a maximum of ± 32 kHz</p> <p>Above 389 ksymbols/sec: ± 1 to $\pm (0.1R_s)$ kHz, up to a maximum of ± 200 kHz</p>
Delay range	0-330 ms
Eb/No Degradation (equal Inbound/Outbound power spectral density)	<p>BPSK = 0.3dB QPSK = 0.3dB OQPSK = 0.3dB 8-PSK = 0.5dB 8-QAM = 0.4dB 16-QAM = 0.6dB</p> <p>For +10 dB power spectral density ratio (outbound interferer 10 dB higher than desired inbound) add an additional 0.3 dB</p>
Monitor Functions	<p>Delay, in milliseconds</p> <p>Frequency offset (between outbound interferer and desired inbound). 100 Hz resolution</p> <p>CnC ratio, in dB (ratio of absolute power, outbound interferer to desired inbound)</p>

3.15.15 Carrier-in-Carrier Summary

Comtech EF Data's DoubleTalk Carrier-in-Carrier can provide significant savings in operational expenses. Considerations include:

- DoubleTalk Carrier-in-Carrier can only be used for full duplex links where the transmitting earth station is able to receive itself.
- DoubleTalk Carrier-in-Carrier can be used in both bandwidth- and power-limited situations.
- The maximum savings is achieved when the original link is symmetric in data rate.

3.15.16 Glossary

Allocated Bandwidth

Bandwidth or Allocated Bandwidth or Occupied Bandwidth is the frequency space required by a carrier on a transponder.

For example, a Duplex E1 (2.048 Mbps) Circuit with 8-PSK Modulation, FEC Rate 3/4 and 1.4 Spacing requires:

$$2.548 \text{ MHz} = 2.048 / (3 * 0.75) * 1.4 * 2$$

For a 36 MHz transponder, 2.548 MHz corresponds to 7.078% Bandwidth Utilization.

Power Equivalent Bandwidth

Power Equivalent Bandwidth (PEB) is the transponder power used by a carrier, represented as bandwidth equivalent.

PEB Calculation Example:

- Transponder EIRP = 37 dBW
- Output Backoff (OBO) = 4 dB
- Available EIRP = $37 - 4 = 33$ dBW = $10^{3.3} = 1955.26$ Watts
- Transponder Bandwidth = 36 MHz
- Power Available / MHz = $1955.26 / 36 = 54.424$ W
- If a carrier uses 24 dBW, its PEB = $10^{2.4} / 54.424$
= 4.532 MHz

This corresponds to 12.59% of available transponder power.

Leased bandwidth

Almost all satellite operators charge for the Leased Bandwidth (LBW). Leased Bandwidth or Leased Resource is the greater of the Allocated Bandwidth and Power Equivalent Bandwidth.

For example, if a carrier requires 3 MHz of Allocated BW and 4.5 MHz of PEB, the Leased Bandwidth is 4.5 MHz

Power Spectral Density (PSD)

Power Spectral Density (PSD) is the signal power per unit bandwidth: **dBW / Hz** or **dBm / Hz**

For example: Signal power = 20 dBm
Signal bandwidth = 500 kHz
PSD = $20 - 10 \cdot \log(500 \cdot 1000)$
= -36.99 dBm / Hz

PSD Ratio

PSD ratio is the ratio of power spectral density of the interfering carrier and the desired carrier. If looking at the 2 carriers side-by-side on a spectrum analyzer:

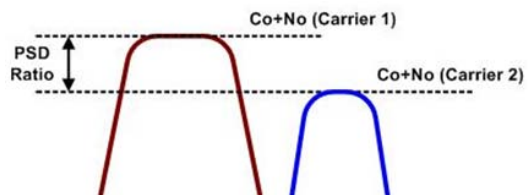

E_b/N_o

Ratio of Energy per bit (E_b) to Noise density (N_o): Unit is dB

C/N

Carrier Power (C) to Noise (N) ratio: Unit is dB

C/N_o

Carrier Power (C) to Noise Density (N_o) ratio: Unit is dBHz

Co+No/No

Carrier Density (C_o) + Noise (N_o) to Noise Density (N_o) ratio: Unit is dB

$$C/N = C/N_o - 10 \log B \text{ [where } B \text{ is bandwidth in Hz]}$$

$$E_b/N_o = C/N_o - 10 \log R \text{ [where } R \text{ is data rate in bits/sec]}$$

$$= C/N + 10 \log B - 10 \log R$$

$$= C/N - 10 \log (\text{Spectral Efficiency})$$

$$E_b/N_o = 10 \log (10^{((C_o+N_o/N_o)/10)} - 1) - 10 \log (\text{Spectral Efficiency})$$

[Spectral Efficiency is in bps / Hz]

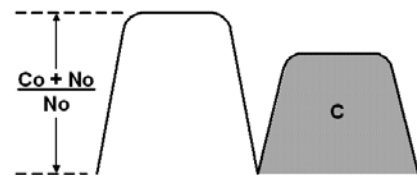

3.16 EDMAC Satellite Framing/Deframing Mode

The modem supports EDMAC satellite framing. EDMAC can be enabled for both modulator and demodulator satellite framing when modem is configured in CLOSED NET applications. EDMAC satellite framing DOES NOT allow control or monitoring of the remote slave modem. On the demodulator, terrestrial data is framed with NULL EDMAC commands, having no effect at the remote demodulator. On the demodulator, EDMAC commands are stripped from the satellite data stream and discarded, leaving the terrestrial data stream intact. EDMAC Framing/Deframing is provided for compatibility purposes only.

3.17 Locating the ID Code Operational Procedure

The modem has unique ID codes that allow the user to add feature upgrades to the modem without the unit having to be returned to the factory. Users are required to identify these ID codes when they want additional features added to their unit. Radyne will supply a new ID code that is required to be entered in the ID code field. Once the new ID code is entered, the modem will activate the new features.

Refer to Appendix B for upgrade procedures.

3.18 Strap Codes

The Strap Code is a quick set key that sets many of the modem parameters. For quick setup of the modem, Strap Codes are very helpful. When a Strap Code is entered, the modem is automatically configured for the code's corresponding data rate, overhead, code rate, framing, scrambler type and modulation. An example of how to set a strap code follows:

Example: In the Ethernet interface <Modulator> Menu, depress the Transmit Gel-tab, then move the cursor down and depress "General". Now move the cursor over to 'Strap Code'. Click inside the box and enter the new strap code submenu and enter #16. The modem will be automatically configured to the parameters shown below in the highlighted row 'Strap Code 16'.

Refer to Appendix D or the various strap code options.

Chapter 4. USER INTERFACES

4.1 User Interfaces

This section contains information pertaining to the user interfaces for the modem. There are four user interfaces available for the modem. These are:

- Front Panel Interface – Refer to section 4.2.
- Terminal Interface - :Refer to section 4.5.

4.2 Front Panel User Interface

The Front Panel of the DMD20/DMD20 LBST allows for complete control and monitor of all DMD20/DMD20 LBST parameters and functions via a keypad, LCD display and status LEDs.

The front panel layout is shown in Figure 4-1 and Figure 4-2 showing the location and labeling of the front panel. The front panel is divided into four functional areas: the LCD Front Panel Display, the Cursor Control Arrow Keys, the Numeric Keypad, and the Front Panel LED Indicators, each described below in Table 4-1.

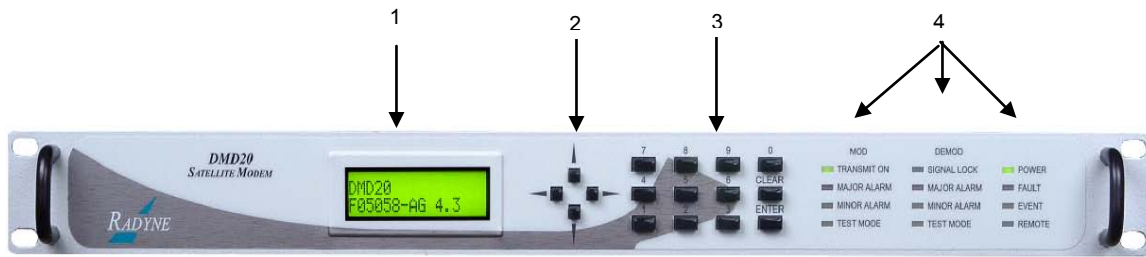

Figure 4-1 DMD20 Front Panel

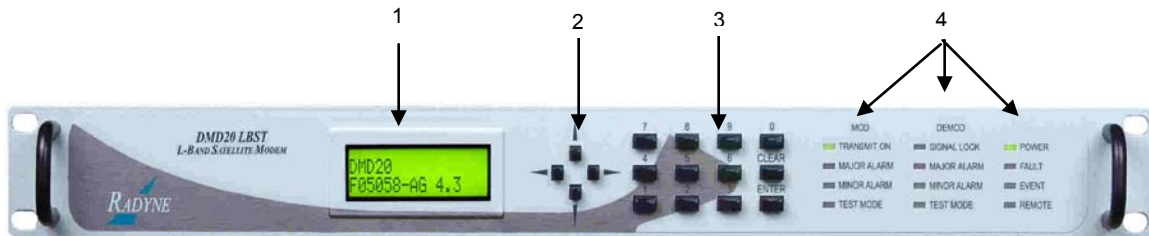

Figure 4-2 DMD20 LBST Front Panel

Table 4-1		
Item Number	Description	Function
1	LCD Front Panel Display	Displays operating parameters and Configuration data
2	Cursor Control Arrow Keys	Controls the up, down, right and left motion of the cursor in the LCD Display window
3	Numeric Keypad	Allows entry of numeric data and Clear and Enter function keys
4	Front Panel LED Indicators	See Paragraph 4.1.4 below for an itemized description of these LEDs

4.2.1 LCD Front Panel Display

The front panel display is a 2 line by 16-character LCD display. The display is lighted and the brightness can be set to increase when the front panel is currently in use. The LCD display automatically dims after a period of inactivity. The display has two distinct areas showing current information. The upper area shows the current parameter being monitored, such as 'Frequency' or 'Data Rate'. The lower line shows the current value of that parameter. The LCD display is a single entry window into the large matrix of parameters that can be monitored and set from the Front Panel.

4.2.2 Cursor Control Arrow Keys

A set of 'Arrow' or 'Cursor' keys (\uparrow), (\downarrow), (\rightarrow), (\leftarrow), is used to navigate the parameter currently being monitored or controlled. Table 4-2 describes the functions available at the Front Panel.

4.2.3 Numeric Keypad

A 10-Key Numeric Keypad with two additional keys for the 'Enter' and 'Clear' function allows the entry of data into the system. Table 4-2 describes the functions available at the Front Panel.

Table 4-2. Edit Mode Key Functions (Front Panel Only)							
Parameter Type	0 – 9	\uparrow	\downarrow	\leftarrow	\rightarrow	'Clear' & \leftarrow	'Clear' & \rightarrow
Fixed Point Decimal	Changes Digit	Toggles \pm (If Signed)	Toggles \pm (If Signed)	Moves Cursor 1 Position Left	Moves Cursor 1 Position Right	N/A	N/A
Unsigned Hexadecimal	Changes Digit	Increments Digit Value	Decrements Digit Value	Moves Cursor 1 Position Left	Moves Cursor 1 Position Right	N/A	N/A
Enumerated	N/A	Previous Value in List	Next Value in List	N/A	N/A	N/A	N/A
Date/ Time	Changes Digit	N/A	N/A	Moves Cursor 1 Position Left	Moves Cursor 1 Position Right	N/A	N/A
IP Address	Changes Digit	Increments Digit Value	Decrements Digit Value	Moves Cursor 1 Position Left	Moves Cursor 1 Position Right	N/A	N/A
Text Strings	Changes Character	Increments Character Value	Decrements Character Value	Moves Cursor 1 Position Left	Moves Cursor 1 Position Right	Clears to Left of Cursor Inclusive	Clears to Right of Cursor Inclusive

4.2.4 Front Panel LED Indicators

Twelve LEDs on the Front Panel (Refer to Table 4-3) indicate the status of operation. The LED colors maintain a consistent meaning. Green signifies that the indication is appropriate for normal operation, Yellow means that there is a condition not proper for normal operation, and Red indicates a fault condition that will result in lost communications.

Table 4-3		
LED	Color	Function
Modem LED Indicators		
Power	Green	Indicates that the unit is turned on.
Fault	Red	Indicates a hardware fault for the unit.
Event	Yellow	Indicates that a condition or event has occurred that the modem has stored in memory. The events may be viewed from the Front Panel or in the Terminal Mode.
Remote	Green	Indicates that the unit is in the process of updating firmware with FTP or flashing indicates some features are demo enabled.
Modulator LED Indicators		
Transmit On	Green	Indicates that the transmitter is on.
Major Alarm	Red	Indicates that the Transmit Direction has failed, losing traffic.
Minor Alarm	Yellow	Indicates that a Transmit Warning Condition exists.
Test Mode	Yellow	Indicates that the transmitter is involved in a current Test Mode activity.
Demodulator LED Indicators		
Signal Lock	Green	Indicates that the receiver locked to an incoming carrier and data, including FEC Sync.
Major Alarm	Red	Indicates that the Receive Direction has failed, losing traffic.
Minor Alarm	Yellow	Indicates that a Receive Warning Condition exists.
Test Mode	Yellow	Indicates that the receiver is involved in a current Test Mode activity.

4.3 Parameter Setup

The four Cursor Control Arrow Keys are used to navigate the menu tree and select the parameter to be set. After arriving at a parameter that needs to be modified, depress <ENTER>. The first space of the modifiable parameter highlights (blinks) and is ready for a new parameter to be entered. After entering the new parameter using the keypad (Refer to Figure 4-2), depress <ENTER> to lock in the new parameter. If a change needs to be made prior to pressing <ENTER>, depress <CLEAR> and the display defaults back to the original parameter. Depress <ENTER> again and re-enter the new parameters followed by <ENTER>.

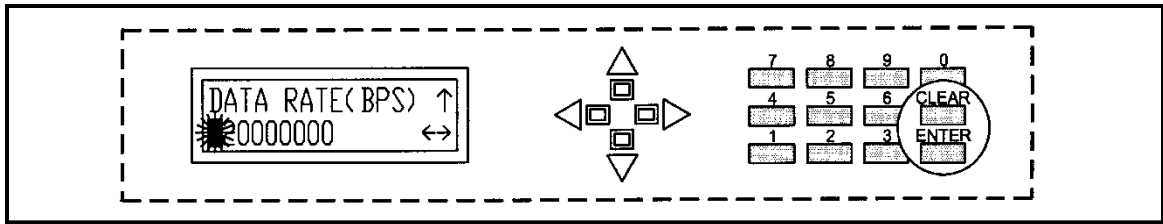

Figure 4-3 Entering New Parameters

Following a valid input, the unit will place the new setting into the nonvolatile EEPROM making it available immediately and available the next time the unit is powered-up.

4.4 Front Panel Control Screen Menus

The Front Panel Control Screens are broken down into sections under several Main Menus.



Menu items for LBST only will be in shaded text.

4.4.1 Main Menus

MODULATOR

DEMODULATOR

INTERFACE

MONITOR

ALARMS

SYSTEM

TEST

4.4.2 Modulator Menu Options and Parameters

NETWORK SPEC

{IDR, IBS, DROP & INSERT, DVB SAT, CLOSED NET}

The Network Spec Command sets a number of parameters within the modem to meet a specification. The purpose is to eliminate keystrokes and potential compatibility problems.

Data rates not covered by a given network specification will not be allowed. If the mode of operation is selected after the data rate has been entered, then the data rate must be compatible with the desired mode of operation or the network spec will not be allowed. The following parameters cannot be changed while the unit is in the given mode of operation:

IDR:

(IESS-308)

For Data rates 1.544, 2.048, 6.312, 8.448 Mbps

Framing Type: 96 Kbps (IDR)

Scrambler Type: V.35

Spectrum Mask: Intelsat

For Data Rates < 1.544

Framing Type: 1/15 (IBS)

Scrambler Type: IESS-309

Spectrum Mask: Intelsat

IBS:

(IESS-309)

For Data Rates \leq 2048

Framing Type: 1/15 (IBS)

Scrambler Type: IESS-309

Spectrum Mask: Intelsat

Drop & Insert:

Data Rates: n x 64 n = 1, 2, 3, 4, 5, 6, 8, 10, 12, 15, 16, 20, 24, 30

Framing Type: 1/15 (IBS)

Scrambler Type: IESS-309

Spectrum Mask: Intelsat

Efficient D&I

Closed Network,
Data Rates: n x 64, N = 1-31 Any combination

Descrambler Type: IESS-309

Spectrum Mask: Intelsat

DVB: Per EN301-421 & En301-210

Data Rates:	All Rates
Framing Type:	DVB
Scrambler Type:	DVB
Spectrum Mask:	DVB 0.25, 0.35

Closed Net:

All possible combinations allowed, however, a DVB setting requires the DVB network spec. .

STRAP CODE**{Refer to Strap Code Guide, Appendix H}**

The Strap Code is a quick set key that sets many modem parameters. Consult the strap code guide for available strap codes. Parameters set by strap code:

- Data Rate
- Inner Code Rate
- Satellite Framing
- Scrambler
- Drop and Insert
- Outer Code Rate (Reed-Solomon)
- Modulation
- Network Spec

IF (menu)**FREQUENCY (MHz)****{50 – 90 MHz, 100 – 180 MHz, or 950 - 2050 MHz}**

Allows the user to enter the Modulator IF Output Frequency of the modem in 1 Hz increments.

UPLINK FREQ

Displays the output frequency of the BUC also referred to as Satellite uplink frequency. The user must enter the BUC LO and OSC SIDE BAND before using this menu. The UPLINK FREQUENCY is a calculated measurement of both the BUC LO and OSC SIDE BAND. Once the menus are entered correctly, the user can control the uplink Frequency from this menu.

POWER (dBm)**{0 to -25 dBm}**

Allows the user to enter the Transmitter Power Level.

CARRIER**{ON, OFF, AUTO, VSAT, RTS}**

Allows the user to select the carrier type. Refer to Appendix E for further information.

SPECTRUM**{NORMAL, INVERTED}**

Allows the user to invert the direction of rotation for QPSK Modulation. Normal meets the IESS Specification..

LBST: Spectral inversion may be required if the BUC LO is higher in frequency than the BUC output frequency. When BUC LO is higher than the BUC output frequency, this creates a spectral inversion and the IF Spectrum must be again inverted to compensate.

MODULATION	{BPSK, QPSK, OQPSK, 8PSK, 16QAM, 8QAM} Allows the user to select the modulation type.																												
SPECTRAL MASK	{Intelsat 0.35, DVB SAT 0.35, DVB SAT 0.25, DVB SAT 0.20} Allows the user to set the spectral shape of Tx Data Filter.																												
COMPENSATION	{0.0 – 1.0} Allows you to offset output power by up to 1 dbm. This is intended as a correction for user cabinet connectors.																												
DATA (menu)																													
DATA RATE (bps)	{Refer to Technical Specs for Data Rates} Allows the user to set the Data Rate in bps steps via the Front Panel Arrows or Keypad.																												
SYMB RATE (sps)	Allows the user to view the Symbol Rate.																												
INNER FEC	<table border="0"> <tr> <td>Viterbi</td> <td>{1/2, 3/4, 7/8, None}</td> </tr> <tr> <td>Optional FEC Rates:</td> <td></td> </tr> <tr> <td>Sequential</td> <td>{1/2, 3/4, 7/8}</td> </tr> <tr> <td>CSC</td> <td>{3/4}</td> </tr> <tr> <td>Trellis (8PSK)</td> <td>{2/3}</td> </tr> <tr> <td>Turbo (BPSK)</td> <td>{5/16, 21/44}</td> </tr> <tr> <td>Turbo (OQPSK/QPSK)</td> <td>{1/2, 3/4, 7/8}</td> </tr> <tr> <td>Turbo (8PSK/8QAM)</td> <td>{3/4, 7/8}</td> </tr> <tr> <td>Turbo (16QAM)</td> <td>{3/4, 7/8}</td> </tr> <tr> <td>DVB VIT</td> <td>{1/2, 2/3, 3/4, 5/6, 7/8}</td> </tr> <tr> <td>DVB Trellis</td> <td>{2/3, 3/4, 5/6, 7/8, 8/9}</td> </tr> <tr> <td>LDPC (B/O/QPSK)</td> <td>{1/2, 2/3, 3/4}</td> </tr> <tr> <td>LDPC (8PSK/8QAM)</td> <td>{2/3, 3/4}</td> </tr> <tr> <td>LDPC (16QAM)</td> <td>{3/4}</td> </tr> </table> <p>Allows the user to select the Tx Code Rate and Type</p>	Viterbi	{1/2, 3/4, 7/8, None}	Optional FEC Rates:		Sequential	{1/2, 3/4, 7/8}	CSC	{3/4}	Trellis (8PSK)	{2/3}	Turbo (BPSK)	{5/16, 21/44}	Turbo (OQPSK/QPSK)	{1/2, 3/4, 7/8}	Turbo (8PSK/8QAM)	{3/4, 7/8}	Turbo (16QAM)	{3/4, 7/8}	DVB VIT	{1/2, 2/3, 3/4, 5/6, 7/8}	DVB Trellis	{2/3, 3/4, 5/6, 7/8, 8/9}	LDPC (B/O/QPSK)	{1/2, 2/3, 3/4}	LDPC (8PSK/8QAM)	{2/3, 3/4}	LDPC (16QAM)	{3/4}
Viterbi	{1/2, 3/4, 7/8, None}																												
Optional FEC Rates:																													
Sequential	{1/2, 3/4, 7/8}																												
CSC	{3/4}																												
Trellis (8PSK)	{2/3}																												
Turbo (BPSK)	{5/16, 21/44}																												
Turbo (OQPSK/QPSK)	{1/2, 3/4, 7/8}																												
Turbo (8PSK/8QAM)	{3/4, 7/8}																												
Turbo (16QAM)	{3/4, 7/8}																												
DVB VIT	{1/2, 2/3, 3/4, 5/6, 7/8}																												
DVB Trellis	{2/3, 3/4, 5/6, 7/8, 8/9}																												
LDPC (B/O/QPSK)	{1/2, 2/3, 3/4}																												
LDPC (8PSK/8QAM)	{2/3, 3/4}																												
LDPC (16QAM)	{3/4}																												
TPC INTERLEAVER	{DISABLE, ENABLE} Allows user to disable or enable the TPC Interleaver. Valid only for Radyne Legacy turbo codes TPC.495 and TPC.793																												
DIFF CODING	{ENABLED, DISABLE} Allows the user to enable or disable the Differential Encoder. Having the encoder enabled ensures proper phase lock. May not be adjustable in some modes.																												
SCRAMBLER SEL	{NONE, V.35-IESS, V.35 CITT, V.35 EF, IBS w/Optional Framing and optional Reed-Solomon, Reed-Solomon Scrambler w/Optional Framing, CCITT, V.35FC, OM-73, V.35EF_RS, TPC SCRAMBLER (Turbo Codec), DVB, EDMAC} Allows the user to select the descrambler type.																												
SCRAMBLER CTRL	{ENABLED, DISABLE} Allows the user to enable or disable scrambler operation.																												
SAT FRAMING	{1/15 (IBS), 1/15 (Async), 96 Kbps (IDR), DVB, EDMAC, EFAUPC, SCC, EFFICIENT D&I, None} <i>Used with IDR, IBS, or Asynchronous Interface Only.</i> Allows the user to select the framing type.																												

IN-BAND RATE	<p>{150, 300, 600, 1200, 2400, 4800, 9600, 19200} Allows the user to select the rate of in-band data for the ES to ES, Async overhead channel. Only displayed when Efficient D&I with Enhanced Async are selected.</p>
SCC CTL RATIO	<p>{1/1, 1/2, 1/3, 1/4, 1/5, 1/6, 1/7}, Allows the user to simulate the framing used by the Satellite Control Channel Option (Pass Thru Mode only). The SCC CTL RATIO is the ratio of overhead in-band data to synchronizing words. Only displayed when SCC Framing is selected</p>
SCC INBAND RATE	<p>{300 to 115200}, when using SCC Framing Allows the user to request the rate of in-band data for the overhead channel. Only displayed when SCC Framing is selected</p>
TERR FRAMING	<p>{NONE, 188, 204}, when using DVB Network Specifications</p>
DATA POLARITY	<p>{INV. TERR & BASE, INV. BASEBAND, INV.TERR DATA, NONE} Use DATA POLARITY to invert the Tx Data polarity if necessary. If other brands of equipment are used with this unit, data polarity inversion may be required.</p>
BPSK SYMB PAIR	<p>{NORMAL, SWAPPED} Allows the user to swap the I & Q Channels, when using BPSK modulation.</p>
ESC OVERHEAD	<p>{VOICE X2, DATA 64KBPS} IDR ESC Channel used for Voice or 64 K data channel. Only available when IDR Network is selected.</p>
REED-SOLOMON (menu)	<p>These selections are visible only when the Reed-Solomon Option is installed.</p>
ENABLE/DISABLE	<p>{ENABLED, DISABLE} Allows the user to Enable/Disable the Reed-Solomon Encoder.</p>
RS RATE	<p>{Refer to Table 3-1 for standard n/k values} Displays the currently used n, k Reed-Solomon Codes. In Closed Net Mode and using the appropriate hardware, the user may select custom R-S Codes.</p>
INTERLVR DEPTH	<p>{4, 8, 12} Allows the user to select the Reed-Solomon interleaver depth. In Closed Net Mode, a depth of 4 or 8 may be selected.</p>
ODU-BUC (menu)	
FSK COMMS	<p>{OFF-NONE/CODAN/TERRASAT/AMPLUS} (Only available when the FSK Comm is Enabled)</p>
	<p>OFF/NONE: Will disable the FSK Communication link. User must select this</p>

option if the BUC does not support FSK or if the customer does not want to utilize the FSK option.

CODAN:

Enables the FSK Communication link for CODAN BUCs only. This feature enables the DMD20LBST to retrieve and display certain BUC parameters on the front panel of the modem.

TERRASAT:

Enables the FSK communication link for Terrasat BUCs only. This feature enables the DMD20LBST to retrieve and display certain BUC parameters on the front panel of the modem.

AMPLUS:

Enables the FSK communication link for AMPLUS BUCs only. This feature enables the DMD20LBST to retrieve and display certain BUC parameters on the front panel of the modem.

**IMPORTANT**

If user enables the FSK and the BUC does not support FSK, the modem will display a fault or if the user selects the incorrect manufacturers BUC, the unit will display a fault.

BUC OUTPUT	{Enabled, Disabled} Allows the user to enable or disable the BUC output
LO FREQ (MHz)	Allows the user to enter the Local Oscillator frequency of the BUC LO in order for the uplink frequency to be displayed correctly (refer to the BUC manufacturer's specifications).

**IMPORTANT**

When utilizing BUC that supports FSK, the modem will display LO frequency as stated by the BUC.

OSC SIDE BAND	{LOW SIDEBAND, HIGH SIDEBAND} Allows the user to select the location of the BUC LO. The user must enter the location of the BUC LO in order for the UPLINK FREQUENCY to be displayed correctly. The BUC LO can be either higher or lower in frequency than the BUC output frequency. If the BUC LO is higher in frequency then the user must enter HIGH SIDEBAND.
10 MHz BUC REF	{ENABLED, DISABLED} Allows the user to enable or disable the 10 MHz BUC reference clock.
BUC VOLTAGE	{ENABLED, DISABLED} Allows the user to enable or disable the BUC supply voltage.
LOW ALARM THRS	{0.00 Volts} Allows user to select lower alarm limit/threshold for BUC voltage.

HI ALARM THRSH	{0.00 Volts} Allows user to select high alarm limit/threshold for BUC voltage.
LOW ALARM THRSH	{0.00 Amps} Allows user to select lower alarm limit/threshold for BUC current.
HI ALARM THRSH	{0.00 Amps} Allows user to select high alarm limit/threshold for BUC current.
CARR DLY (SEC)	{0 to 255} Allows the user to select the time delay after power-up before the Tx Carrier may be enabled. This allows time for the BUC to stabilize.
ADDRESS	{xxxx} Allows the user to enter the BUCs address for FSK communications. Modem may be able to retrieve address through the FSK Query for Address Test menu.
BUC TX ENABLE	{Enable/Disable} (Only available when the FSK Comm is Enabled) Enables or Disables the BUC RF Output.
FSK TEST	{NONE/LOOPBACK/CYCLE TX ENABLE/QUERY FOR ADDRESS/PASS THRU} (Only available when the FSK Comm is Enabled)
	NONE: This is the none FSK operational mode.
	LOOPBACK: The FSK will initiate an internal loopback test of the FSK transmitter and receiver verifying that the modem communication link is functioning properly.
	CYCLE TX ENABLE: The modem will initiate a test of the FSK between the modem and BUC. The LBST will enable and disable the BUC RF output and verify that the commands are properly received and accepted by the BUC and the modem. If communications are lost, LBST will initiate a fault.
	QUERY FOR ADDRESS The modem will initiate a FSK query requesting BUC address.
	PASS THRU: Allows the user to communicate with the BUC utilizing the BUCs message protocol via the Remote ports (Terminal, Web Browser, RLLP and SNMP).

AUPC (menu)**LOCAL AUPC (menu)**

The 'LOCAL AUPC CONFIGURATION' Menu contains the local configuration parameters for the AUPC Function.

AUPC MODE

{DISABLED, NEAR SIDE, RADYNE, EFDATA}

DISABLED: Allows the user to enable or disable the Local AUPC Function of the local modem.

EFDATA: Enables EFDATA Local AUPC Function. In the event that the remote or local demodulator losses lock, the output power level will adjust itself to the level settings indicated in the 'REMOTE CL ACTION' Menu or the 'LOCAL CL ACTION'.

RADYNE: Enables Radyne Local AUPC Function. In the event the remote demodulator losses lock, the local output power level will adjust itself to the nominal level. This nominal power should be set to a level high enough to re-establish communications regardless of rain fade.

NEAR SIDE: Enables NEARSIDE Local AUPC function. In the event the local demodulator losses lock due to signal loss, the output power level will adjust itself to the nominal level. This nominal power should be set to a level high enough to re-establish communications regardless of rain fade.

NOMINAL TX POWER

{0 TO -25 dB}

This allows the user to set the nominal Transmit Power. The nominal transmit power is the default output power level.

MINIMUM TX POWER

{0 to -25 dB}

This allows the user to set the minimum Transmit Power.

EFDATA AUPC: When configured for EFDATA AUPC the minimum Transmit Power is the lowest power setting that will be used when the local modem commands a decrease of the Transmit Power from the Remote modem.

RADYNE: When configured for Radyne AUPC, the minimum Transmit Power is the lowest power setting that will be used when the remote modem commands a decrease of the Transmit Power from the Local modem.

NEARSIDE: When configured for NEARSIDE AUPC the minimum Transmit Power is the lowest power setting that will be used by the local modem when the Eb/No increases above the Eb/No target.

MAXIMUM TX POWER

{0 to -25 dB}

This allows the user to set the maximum Transmit Power.

EF AUPC: When configured for EF AUPC, the maximum Transmit Power is the highest power setting that the local modem will use when the local modem commands an increase in Transmit power from the Remote modem.

	<p>RADYNE: When configured for Radyne AUPC, the maximum Transmit Power is the highest power setting that will be used when the remote modem commands an increase of the Transmit Power from the Local modem</p> <p>NEARSIDE: When configured for NEARSIDE AUPC the maximum Transmit Power is the highest power setting that will be used by the local modem when the E_b/N_o decreases below the E_b/N_o target.</p>
TARGET E_b/N_o	<p>{4.0 to 16 dB} This allows the user to set the desired E_b/N_o for the local receiver.</p> <p>RADYNE AUPC: When configured for Radyne AUPC, this setting is compared against the remote E_b/N_o and commands to the local modem to increase or decrease the local transmit power.</p> <p>EF AUPC: When configured for EF AUPC, this setting is compared against the local received E_b/N_o and commands to the remote modem to increase or decrease transmit power.</p> <p>NEARSIDE: When configured for NEARSIDE AUPC, this setting is compared against the received E_b/N_o of the local modem and commands to the local modem to increase or decrease transmit power.</p>
TRACKING RATE	<p>{0.5 to 6.0} Allows the user to set the rate at which the commands to increase or decrease Transmit Power are sent. Each command will result in a 0.5 dB increase or decrease in Transmit Power from the remote transmitter. The tracking rate is adjustable from 0.5 dB per minute to 6.0 dB per minute in 0.5 dB steps. (Only available when EFAUPC is selected as the framing)</p>
LOCAL CL ACTION	<p>{HOLD, NOMINAL, MAXIMUM} This allows the user to set the Remote Transmit Power Setting to be used when the local modem receiver loses lock. The setting can be 'HOLD' (no action taken), 'NOMINAL' (the nominal Transmit Power Setting is used), and 'MAXIMUM' (the maximum Transmit Power Setting is used). (Only available when EFAUPC is selected as the framing)</p>
REMOTE CL ACTION	<p>{HOLD, NOMINAL, MAXIMUM} This allows the user to set the Local Transmit Power Setting to be used when the remote modem receiver loses lock. The setting can be 'HOLD' (no action taken), 'NOMINAL' (the nominal Transmit Power Setting is used), and 'MAXIMUM' (the maximum Transmit Power Setting is used).</p>
REMOTE AUPC (menu)	<p>The 'REMOTE AUPC CONFIGURATION' Menu contains the remote configuration parameters for the AUPC Function. Remote AUPC menus are only available when modem is configured for EF AUPC</p>

AUPC MODE	{DISABLE, NEAR SIDE, EFDATA} Allows the user to enable or disable the AUPC Function of the remote modem. The remote AUPC Function is the response of the local modem to commands for an increase or decrease of the Transmit Power in 0.5 dB steps and the command to change to the setting indicated in the 'REMOTE CL ACTION' Menu of the remote modem upon receiver loss of lock.
LOOPBACK	{DISABLE, ENABLE} Allows the user to enable or disable the Baseband Loopback Test Mode of the remote modem.
TX 2047 TEST	{DISABLE, ENABLE} Allows the user to enable or disable the Transmit 2047 Pattern Test Mode of the remote modem.
RX 2047 BER:	Reports the BER measurement of the receiver 2047 Pattern Test Mode of the remote modem. BER is reported from the 1×10^{-5} to 1×10^{-7} in tenth decade steps. if the pattern does not synchronize or is out of range, 'NO DATA' will be displayed.

**IMPORTANT**

When modems are configured for Radyne AUPC, the remote Eb/No will be displayed in the Monitor Menus.

4.4.3 Demodulator Menu Options and Parameters

NETWORK SPEC

{IDR, IBS, DROP & INSERT, DVB SAT, LDPC, CLOSED NET}

The Network Spec Command sets a number of parameters within the modem to meet a specification. The purpose is to eliminate keystrokes and potential compatibility problems.

Data rates not covered by a given mode will not be allowed. If the mode of operation is selected after the data rate has been entered, then the data rate must be compatible with the desired mode of operation or the Network Spec will not be allowed. The following parameters cannot be changed while the unit is in the given mode of operation:

IDR:

(IESS-308)

For Data rates 1.544, 2.048, 6.312, 8.448 Mbps

Framing Type: 96 Kbps (IDR)

Descrambler type: V.35

Spectrum Mask: Intelsat

For Data Rates < 1.544 Mbps

Framing Type: 1/15 (IBS)

Descrambler Type: IESS-309

Spectrum Mask: Intelsat

IBS:

(IESS-309)

For Data Rates \leq 2.048 Mbps

Framing Type: 1/15 (IBS)

Descrambler Type: IESS-309

Spectrum Mask: Intelsat

Drop & Insert:

Data Rates: n x 64, n = 1, 2, 3, 4, 5, 6, 8, 10, 12, 15, 16, 20, 24, 30

Framing Type: 1/15 (IBS)

Descrambler Type: IESS-309

Spectrum Mask: Intelsat

Efficient D&I

Closed Network,
Data Rates: n x 64, 1-31 Any combination

Descrambler Type: IESS-309

Spectrum Mask: Intelsat

DVB: Per EN301-421 & En301-210

Data Rates: All Rates

Framing Type: DVB

Scrambler Type: DVB

Spectrum Mask: DVB 0.25, 0.35

Closed Net:

All possible combinations allowed, however, a DVB setting requires the DVB network spec.

STRAP CODE**{Refer to Strap Code Guide, Appendix H}**

The Strap Code is a quick set key that sets many modem parameters. Consult the strap code guide for available strap codes. Parameters set by strap code:

Data Rate
 Inner Code Rate
 Satellite Framing
 Scrambler
 Drop and Insert
 Outer Code Rate (Reed-Solomon)
 Modulation
 Network Spec

IF (menu)

FREQUENCY (MHz) **{50 – 90 MHz, 100 – 180 MHz, or 950 - 2050 MHz}**
{950 – 2050 MHz} for LBST}
 Allows the user to enter the Modulator IF Frequency in 1 Hz increments.

DWNLNK FREQ (MHz) Displays the input frequency into the LNB from the satellite, also referred known as Satellite downlink frequency. The user must enter the LNB LO and OSC SIDEBAND of the LNB before using this menu. The DOWNLINK FREQUENCY is a calculated measurement of both the LNB LO and OSC SIDE BAND. Once the menus are entered correctly, the user can control the downlink Frequency from this menu.

SPECTRUM**{NORMAL INVERTED}**

Allows the user to invert the direction of rotation for PSK Modulation. Normal meets the IESS Specification.

LBST: Spectral inversion may be required if the LNB LO is higher in frequency than the LNB input frequency from the satellite. When LNB LO is higher in frequency than the LNB input frequency, this creates a spectral inversion and the IF Spectrum must be inverted to compensate for the inversion.

MODULATION**{QPSK, BPSK, OQPSK, 8PSK, 16QAM, 8QAM}**

Allows the user to select the demodulation type.

SPECTRAL MASK**{Intelsat 0.35, DVB 0.35, DVB 0.25, DVB 0.20}**

Allows the user to set the spectral shape of Tx Data Filter.

SWEEP RANGE (kHz)**{±0 to 255 kHz}**

Allows the user to set the acquisition range for the demodulator

SWEEP DELAY (Sec)**{0.0 – 6553.5 sec}**

Allows the user to set the reacquisition delay time in 1/10th second increments.

REACQ RANGE (Hz)	{0 – 65535 Hz} Allows the user to set the reacquisition sweep in 1 Hz increments.
ADJ CARRIER PWR	{Normal, Suppressed} Allows the user to indicate adjacent carrier as Normal or Suppressed (High Power). Unit will increase or decrease post decimation gain appropriately.
FAST ACQUISITION	{DISABLED, ENABLED} Allows the user to disable or enable the Rx fast acquisition capability.



Limitations of Fast Acquisition:

The maximum symbol rate for Fast Acquisition is 1028Ksps.

Fast Acquisition must be disabled for rates greater than 1028Ksps.

Only supports QPSK and 8PSK in a NON-DVB MODE.

Does not support spectral inversion applications.

INPUT THRESHOLD (dBm)	{-30 to 90 dbm} Allows the user to adjust the low level threshold limit for input power. Input power level below the threshold limit will trigger a major alarm on the demodulator.
EB/NO ALARM	{0.0 to 9.90 db} Allows the user to set the desired E_b/N_o for the local receiver. This setting is compared against the receive E_b/N_o and commands to the remote modem to increase or decrease Transmit Power accordingly are sent.

DATA (menu)

DATA RATE (bps)	{Refer to Technical Specs for Data Rates} Allows the user to set the Data Rate in bps steps via the Front Panel Arrows or Keypad.
SYMB RATE (sps)	Allows the user to view the Symbol Rate.
INNER FEC	<p>Viterbi {1/2, 3/4, 7/8, None}</p> <p>Optional FEC Rates:</p> <p>Sequential {1/2, 3/4, 7/8}</p> <p>CSC {3/4}</p> <p>Trellis (8PSK) {2/3}</p> <p>Turbo (BPSK) {21/44, 3/4, 7/8}</p> <p>Turbo (OQPSK/QPSK) {1/2, 3/4, 7/8}</p> <p>Turbo (8PSK/8QAM) {3/4, 7/8}</p> <p>Turbo (16QAM) {3/4, 7/8}</p> <p>DVB VIT {1/2, 2/3, 3/4, 5/6, 7/8}</p> <p>DVB Trellis {2/3, 3/4, 5/6, 7/8, 8/9}</p> <p>LDPC (B/O/QPSK) {1/2, 2/3, 3/4}</p> <p>LDPC (8PSK/8QAM) {2/3, 3/4}</p> <p>LDPC (16QAM) {3/4}</p> <p>Allows the user to select the Rx Code Rate and Type</p>

ROTATION AMBIG	{n (x.x.x)}, n=0..7, x=0 or 1 (8PSK Only)
	Allows the user to manually set the rotational ambiguity of the uncoded* 8PSK constellation. This will force the rotation to one of the eight possible states after demodulator lock.
	*This is not a normal mode of operation for the modem.
TPC INTERLEAVER	{DISABLED, ENABLED}
	Allows the user to disable or enable TPC Interleaver. Valid only for Radyne Legacy turbo codes TPC.495 and TPC.793.
DIFF CODING	{ENABLED, DISABLE}
	Allows the user to enable or disable the Differential Decoder. Having the decoder enabled ensures proper phase lock. May not be adjustable in some modes.
SCRAMBLER SEL	{NONE, V.35-IESS, V.35 CITT, V.35 EF, IBS w/Optional Framing and optional Reed-Solomon, Reed-Solomon Scrambler w/Optional Framing, CCITT, V.35FC, OM-73, V.35EF_RS, TPC SCRAMBLER (Turbo Codec), DVB, EDMAC}
	Allows the user to select the descrambler type.
SCRAMBLER CTRL	{ON, OFF}
	Allows the user to enable or disable the descrambler operation.
SAT FRAMING	{1/15 (IBS), 1/15 (Async), 96 Kbps (IDR), EDMAC, EFAUPC, SCC, EFFICIENT D&I, None} <i>Used with IDR, IBS, or Asynchronous Interface Only.</i>
	Allows the user to select the Framing Type.
IN-BAND RATE	{150, 300, 600, 1200, 2400, 4800, 9600, 19200}
	Allows the user to select the rate of in-band data for the ES to ES, Async overhead channel. Only displayed when Efficient D&I with Esc Enhanced are selected.
SCC CTL RATIO	{1/1, 1/2, 1/3, 1/4, 1/5, 1/6, 1/7}
	Allows the user to simulate the framing used by the Satellite Control Channel Option (Pass Thru Mode only). The SCC CTL RATIO is the ratio of overhead in-band data to synchronizing words. Only displayed when SCC Framing is selected.
SCC INBAND RATE	{300 to 115200},
	Allows the user to request the rate of in-band data for the overhead channel. Only displayed when SCC Framing is selected.
TERR FRAMING	{NONE, 188, 204}, when using DVB Network Spec
DATA POLARITY	{INV. TERR & BASE, INV. BASEBAND, INV.TERR DATA, INV. NONE}
	Use DATA POLARITY to invert the Rx Data polarity if necessary. If other brands of equipment are used with this unit, data polarity inversion may be required.

BPSK SYMB PAIR	{NORMAL, SWAPPED} Allows the user to swap the I & Q Channels, when using BPSK Modulation.
ESC OVERHEAD	{VOICE X2, DATA 64KBPS} IDR ESC Channel used for Voice or 64 K data channel. Only available when IDR Network is selected.
REED-SOLOMON (menu)	These selections are visible only when the Reed-Solomon Option is installed.
ENABLE/DISABLE	{ENABLED, DISABLED} Allows the user to Enable/Disable the Reed-Solomon Encoder.
RS RATE	{Refer to Table 3-1 for standard n/k values} Displays the currently used n, k Reed-Solomon Codes. In Closed Net Mode and using the appropriate hardware, the user may select custom R-S Codes.
INTERLVR DEPTH	{4, 8, 12} Allows the user to select the Reed-Solomon interleaver depth.
ODU-LNB (menu)	
LO FREQ (MHz)	Allows the user to enter the Local Oscillator frequency in MHz in order for the downlink frequency to be displayed correctly (refer to the LNB manufacturer's specifications).
OSC SIDE BAND	{LOW SIDEBAND, HIGH SIDEBAND} Allows the user to select the location of the LNB LO. The user must enter the location of the LNB LO in order for the UPLINK FREQUENCY to be displayed correctly. The LNB LO can be either higher or lower in frequency than the LNB output frequency. If the LNB LO is higher in frequency then the user must enter HIGH SIDEBAND.
10 MHz LNB REF	{ENABLED, DISABLED} Allows the user to enable or disable the 10 MHz BUC reference clock.
VOLTAGE SELECT	{13 VDC, 15 VDC, 18 VDC, 20 VDC} Allows the user to select the voltage required by the LNB (refer to the LNB manufacturer's specifications).
LNB VOLTAGE	{ENABLED, DISABLED} Allows the user to enable or disable the LNB supply voltage.
LOW ALARM THRSH	{0.00 Volts} Allows user to select lower alarm limit/threshold for LNB voltage.
HI ALARM THRSH	{0.00 Volts} Allows user to select high alarm limit/threshold for LNB voltage.
LOW ALARM THRSH	{0.00 Amps} Allows user to select lower alarm limit/threshold for LNB current.

HI ALARM THRSH	{0.00 Amps} Allows user to select high alarm limit/threshold for LNB current.
-----------------------	---

CNC (menu) These selections are visible only when the Carrier in Carrier card is installed.

ENABLE/DISABLE **{ENABLED, DISABLED}**
Allows the user to Enable/Disable the Carrier in Carrier.

MIN SRCH DELAY **{Minimum Search Delay (ms), 0 to Max}**

MAX SRCH DELAY **{Maximum Search Delay (ms), Min to 330ms}**

FREQ OFFST RNG **{Range of Frequency Offset (KHz) between the Interferer and the desired received signal. (+/- 1Khz to +/- 32Khz)}**

4.4.4 Interface Menu Options and Parameters

TX SETUP (menu)

CIRCUIT ID Allows the user entry of a Tx Circuit Identifier. Circuits can be given up to an 11 Character alphanumeric identity such as LINK1.

TERR INTERFACE **STANDARD INTERFACE**
{RS422 SERIAL,RS232 SERIAL, V.35}

OPTIONAL HARDWARE INTERFACES
{M2P PARALLEL, DVB PARALLEL, ASI}
{HSSI}
{ETHERNET 10/100 BASE-T}
{ETHERNET 10/100/1000 BASE-T}
{G.703: T1 AMI, T1 B8ZS, , E1 BAL, E1 UNBAL, T2 BAL, T2 UNBAL, E2}
Allows the user to select the Transmit Interface Type.

ETH FLOW CONTROL **{Disabled, Enabled}**
Allows the user to disable or enable flow control. *Only visible when Ethernet is selected as the interface type.*

ETH DAISY CHAIN **{Disabled, Enabled}**
Allows the user to disable the Ethernet Port Daisy Chaining. *Only visible when Ethernet is selected as the interface type.*

ETH QOS TYPE **{NORMAL, PORT BASED}**
Selects the priority hierarchy of processing an IEEE 803.3ac Tag, Ipv4 Type of Service Field / Differentiated Services Field, or Ipv6 Traffic Class Field. The Port Based priority overrides any standard priority. When operating in this mode, (JS1) has the highest priority and (JS4) has the lowest.

ETH QOS QUEUE **{FAIR WEIGHTED, STRICT PRIORITY}**
Selects the queue weighting of 8,4,2,1 that insures even the lowest priority traffic gets some bandwidth. Strict Priority insures that the higher priority traffic will always be transmitted before

	any lower priority traffic. With this setting, the lower priority traffic can starve.
ETH CRC ROUTE	{NORMAL, BYPASS} Determines how the modem will route a packet with a bad CRC. In normal mode the modem will drop a packet that has an incorrect CRC, when bypassed the modem will pass on the packet even with an incorrect CRC.
ETH HDLC	{RADYNE, COMTECH} Selects Radyne's HDLC or Comtech's HDLC.
TX CLK SRC	{SCTE, SCT, EXT CLK} Allows the user to select the Transmit Clock Source.
TX CLK POL	{AUTO, NORMAL, INVERTED} Allows the user to select the Clock Polarity for the Tx Terrestrial Clock relative to the Tx Data. "Auto" detects wrong polarity and automatically corrects. If G.703 Interface is selected, this selection cannot be changed.
SCT CLK SRC	{SCT, SCR} Allows the user to select SCT Source. SCT is the internally generated SCT clock. SCR is the Rx Satellite clock. SCR is used for loop timing.
DROP & INSERT (menu)	(Reference Section 3.14, "Drop and Insert Mapping" in this manual)
DROP MODE	{NONE, T1-D4, T1-ESF, PCM-30, PCM-30C, PCM-31, PCM-31C, T1-D4-S, T1-ESF-S.} Drop mode may only be changed from none when the drop and insert specification is in use.
MAP COPY	{SRC Map → Dest Map} Allows the user to copy drop and insert maps. Tx Act map is the drop map currently being used by the modem. Source and destination may be any of the following: TX ACT, RX ACT, TX EDIT, RX EDIT, USER 1 - USER 8, ROM 1 -ROM 8
SAT CH TERRCH	{1-31 1-31} The up/down arrow keys allow you to traverse the sat terr pairings. The slot numbers may be edited using the keypad. Allows the user to edit the Tx Edit map and specify the terrestrial slots that will be dropped into the assigned satellite channels. The satellite channels are fixed and the number of channels is determined by the data rate. The terrestrial time slots available are determined by the drop mode. When the user has finished editing the Tx Edit map, it must be copied to the Tx Act map before it will be used by the modem.

ESC CHAN#1 (dB) {-20 to +10 dB}
Allows user to select ESC Voice Channel Gain. Only displayed when IDR NETWORK and VOICE Channel are selected.

ESC CHAN#2 (dB) {-20 to +10 dB}
Allows user to select ESC Voice Channel Gain. Only displayed when IDR NETWORK and VOICE Channel are selected.

RX SETUP (menu)

CIRCUIT ID Provides entry of Rx Circuit Identifier. Circuits can be given up to an 11 Character alphanumeric Identity such as DLINK1

TERR INTERFACE **STANDARD INTERFACE**
 {RS422 SERIAL,RS232 SERIAL, V.35}
OPTIONAL HARDWARE INTERFACES:
 {M2P PARALLEL, DVB PARALLEL, ASI}
 {HSSI}
 {ETHERNET 10/100 BASE-T}
 {ETHERNET 10/100/1000 BASE-T}
 {G.703: T1 AMI, T1 B8ZS, , E1 BAL, E1 UNBAL, T2 BAL, T2 UNBAL, E2}
 Allows the user to select the Transmit Interface

BUFF SIZE (msec) {0 - 64 msec}
 Allows the user to set the Doppler Buffer Size in msec.

BUFFER CLK SRC The user must assign priorities to the clock sources. 1 being the highest priority and 5 being the last resort. The menu has three fields; the first field is the name of the clock source, the second field is the priority entry area, and the last field is the depth of the list. In the priority field, the up/down arrow keys will scroll through the list displaying the names and the current priority. When the desired clock name is displayed, the number keys may be used to assign a priority value. Pressing <Enter> will re-sort the list. Do this until the clock sources are prioritized in the order desired. Use the left/right arrow keys to move the cursor to the depth field. This field assigns the number of entries to use. The number keypad or the up/down arrows can be used to change the value.

<u>Clock Source</u>	<u>Priority</u>	<u>SRC DEPTH</u>	
RX SAT	1	of 3	} Only these will be used
SCTE	2	of 3	
SCT	3	of 3	
EXT BNG	4	of 3	} Will not be used since 4>3 and 5>3
EXT IDI	5	of 3	

MAP COPY {SRC Map → Dest Map}

Allows the user to copy drop and insert maps. Tx Act map is the drop map currently being used by the modem. Source and destination may be any of the following:

	TX ACT, RX ACT, TX EDIT, RX EDIT, USER 1 - USER 8, ROM 1 -ROM 8
SAT CH TERRCH	{1-31 1-31} The up/down arrow keys allow you to traverse the sat terr pairings. The slot numbers may be edited using the keypad. Allows the user to edit the Tx Edit map and specify the terrestrial slots that will be dropped into the assigned satellite channels. The satellite channels are fixed and the number of channels is determined by the data rate. The terrestrial time slots available are determined by the drop mode. When the user has finished editing the Tx Edit map, it must be copied to the Tx Act map before it will be used by the modem.
BUFFER CLOCK POL	{NORMAL, INVERTED} Allows the user to select the Buffer Clock Polarity for the Tx Terrestrial Clock relative to the Tx Data. If G.703 Interface is selected, this selection cannot be changed.
DROP & INSERT (menu)	
INSERT MODE	{NONE, T1-D4, T1-ESF, PCM-30, PCM-30C, PCM-31, PCM-31C, T1-D4-S, T1-ESF-S.} Allows the user to select any of the above.
T1/E1 FRAME SRC	{INTERNAL, EXTERNAL} Selects the frame source for T1 or E1 framing.
TERR STREAMING	{BYTE OUTPUT, PACKET OUTPUT} ASI only Byte output = continuous Packet output = burst
ESC CHAN#1 (dB)	{-20 to +10 dB} Allows user to select ESC Voice Channel Gain. Only displayed when IDR NETWORK and VOICE Channel are selected.
ESC CHAN#2 (dB)	{-20 to +10 dB} Allows user to select ESC Voice Channel Gain. Only displayed when IDR NETWORK and VOICE Channel are selected.
RX ASYNC MODE	{ES-ES, ESC ENHANCED} ES-ES is displayed when IBS Network Spec is selected. ESC Enhanced can be selected in Closed Net and uses the Overhead Signaling bytes in the IBS Overhead to pass asynchronous data. This menu is not available when SCC is selected.
TERR STREAMING	{BYTE OUTPUT, PACKET OUTPUT} ASI only Byte output = continuous Packet output = burst
GENERAL (menu)	
EXT FREQ (MHz)	{Variable Through Data Rate} Allows the user to select the external clock frequency in MHz.

REF FREQ SRC	{INTERNAL, EXTERNAL, HIGH STABILITY} Allows the user to select the Frequency Reference Source. High Stability is only displayed if the appropriate hardware is detected.
REF FREQ (MHz)	Allows the user to select the reference clock frequency in MHz.
BB RELAYS	{IBS ALMs, IBS/MNR ALMs, IBS/MNR/MJR ALM, RTS ALARM} IBS ALMs: Only supports IBS prompt and service alarms. NOTE: THE FOLLOWING MENUS ARE ONLY SUPPORTED IN CLOSED NETWORK IBS/MNR ALMs: Only supports IBS prompt and service alarms and minor alarms IBS/MNR/MJR ALM: Only supports IBS prompt and service alarms, minor and major alarms. RTS Alarm: Allows contact closures to be activated when the carrier is configured for RTS signaling. Refer to Radyne App Note 230 for addition information on utilizing this feature as Keyline Operation.
TX ASYNC MODE (menu)	
TX ASYNC MODE	{ES-ES, ESC ENHANCED} ES-ES is the normal IBS Async Channel. ESC Enhanced can be selected in Closed Net and uses the Overhead Signaling bytes in the IBS Overhead to pass asynchronous data. This menu is not available when SCC is selected.
ES INTERFACE	{RS-232, RS-485} Allows the user to select the interface type.
ES BAUDRATE	{150 – 1024} For IBS ES to ES {150 – 19200} For ES to ES Enhanced {150 – 115200} For SCC Communications ES to ES : Fixed Baud Rate based on IBS Network Specification. Available rates are listed in Table 3-3. ES to ES Enhanced: Allows user to select the Interface Baud Rate. This selection will allow the user to set rate as listed in Table 3-3. SCC: Allows user to select the interface Baud rate. Interface Rate must be equal to or greater than the In-Band Rate.
ES BITS/CHAR	{7, 8} Allows the user to choose between 7 or 8 bit data.
RX ES ENHANCED (menu)	
RX ASYNC MODE	{ES-ES, ESC ENHANCED} ES-ES is displayed when IBS Network Spec is selected. ESC Enhanced can be selected in Closed Net and uses the Overhead Signaling bytes in the IBS Overhead to pass asynchronous data. This menu is not available when SCC is selected.
ES INTERFACE	{RS-232, RS-485} Allows the user to select the interface type.

ES BAUDRATE	<p>{150 – 1024} For IBS ES to ES {150 – 19200} For ES to ES Enhanced {150 – 115200} For SCC Communications</p> <p>ES to ES : Fixed Baud Rate based on IBS Network Specification. Available rates are listed in Table 3-3.</p> <p>ES to ES Enhanced: Allows user to select the Interface Baud Rate. This selection will allow the user to set rate as listed in Table 3-3.</p> <p>SCC: Allows user to select the interface Baud rate. Interface Rate must be equal to or greater than the In-Band Rate.</p>
ES BITS/CHAR	<p>{7,8}</p> <p>Allows the user to choose between 7 or 8 bit data.</p>

4.4.5 Monitor Menu Options and Parameters

EVENTS	Displays a history of events recorded in the event buffer. A maximum of 100 events may be stored in the buffer. Upon receipt of the 101 st event, the first received event is automatically deleted, and so on, maintaining the maximum 100 events.
ERASE EVENTS.. PRESS CLEAR	Allows the user to clear the contents of the Event Buffer by pressing <CLEAR> on the keypad.
INPUT LVL (dBm)	Displays the estimated receive signal level as seen by the Demodulator.
FREQ OFFSET	Displays the received carrier frequency offset as measured by the modem.
AGC VOLATAGE (V)	Monitored AGC Value for use in external equipment such as Radios.
EBNO (dB)	Displays the estimated E_b/N_o as seen by the demodulator.
REMOTE EB/NO	Remote EB/NO displayed when modem is configured for Radyne AUPC.
RAW BER	Displays the estimated channel error rate (before decoding) measured by the modem.
CORRECTED BER	The CBER display shows an estimated corrected bit error rate of the modem. Depending on the symbol rate the modem is running, the high-end performance scale of this display will vary ($10 E^{-9}$, 10^{-10} or 10^{-11}). At some symbol rates, a better than scale reading will appear as 0.0×10^{00} . At other symbol rates, it will appear as E^{**} . In either case, they both mean performance is better than the scale upper limit.
BIT ERRORS	Displays the current error count from the Viterbi Decoder. (NOT DISPLAYED FOR TPC OR LDPC MODES)
ETHERNET LINK STATUS (menu)	<i>(the following sub menus only display when Ethernet is selected as the interface type)</i>

TOTAL PACKETS	Displays the total number of Ethernet packets received from the satellite <i>(Only visible when Ethernet is selected as the interface type)</i> .
ERROR PACKETS	Displays the number of error Ethernet packets received from the satellite <i>(Only visible when Ethernet is selected as the interface type)</i> .
PKT ERROR RATE	Displays the satellite Packet Error Rate <i>(Only visible when Ethernet is selected as the interface type)</i> .
PKT STATS RESET	Allows the user to reset the Ethernet packet statistics by pressing <Enter> <i>(Only visible when Ethernet is selected as the interface type)</i> .
LINK STATUS (menu)	<i>(the following sub-menus only display when Ethernet is selected as the interface type)</i>



The status of the following ports may be one of the following:

Down:	The link is down.
Unresolved:	Unable to agree on connection speed.
10 Mbps Half:	Connected at 10 Base-T Half Duplex.
10 Mbps Full:	Connected at 10 Base-T Full Duplex.
100 Mbps Half:	Connected at 100 Base-T Half Duplex.
100 Mbps Full:	Connected at 100 Base-T Full Duplex.
Unused:	The port is not available.

JS1 PORT	{See the note above} Displays the current status of the LAN Port.
JS2 PORT	{See the note above} Displays the current status of the LAN Port.
JS3 PORT	{See the note above} Displays the current status of the LAN Port.
JS4 PORT	{See the note above} Displays the current status of the LAN Port.
WAN STATUS	{See the note above} Displays the current status of the WAN Port.
VOLTAGES (menu)	
+1.5V RX SUPPLY	Displays the measured voltage of the 1.5 Volt Rx power bus located inside the modem.
+1.5V TX SUPPLY	Displays the measured voltage of the 1.5 Volt Tx power bus located inside the modem.
+3.3V SUPPLY	Displays the measured voltage of the +3.3 Volt power bus located inside the modem.
+5V SUPPLY	Displays the measured voltage of the +5 Volt power bus located inside the modem.

+12V SUPPLY	Displays the measured voltage of the +12 Volt power bus located inside the modem.
+20V SUPPLY	Displays the measured voltage of the +20 Volt power bus located inside the modem.
-12V SUPPLY	Displays the measured voltage of the -12 Volt power bus located inside the modem.
LNB CURRENT	Displays the measured current of the LNB.
LNB VOLTAGE	Displays the measured voltage of the LNB.
BUC CURRENT	Displays the measured current of the BUC.
BUC VOLTAGE	Displays the measured voltage of the BUC.

ODU - BUC (menu)

POWER OUTPUT	Displays the RF OUTPUT (dBm) of the BUC.
TEMPERATURE	Displays the measured temperature of the BUC.
BUC SUMMARY	Displays the BUC summary when information is supplied by the BUC.



IMPORTANT

The ODU- BUC status menus are only displayed when BUC supports FSK and information is supplied by the BUC.

CnC (menu)

CnC DELAY	Routine delay (ms)
CnC FREQ OFFST	Runtime Frequency Offset (KHz) between interferer and the desired received signal.
CnC RATIO	Power Ratio between interferer and the desired signal in dB.
RX BUFFER LEVEL	{0 – 100%} Displays the status of the Doppler Buffer.
RX BUFFER RESET ((ENTER))	Allows the user to re-center the Doppler Buffer when <ENTER> is pressed on the keypad.

4.4.6 Alarms Menu Options and Parameters



Masking alarms may cause undesirable modem performance.

CURRENT ALARMS (menu)

TX MAJOR (menu)	<u>Status</u> <u>Edit Table</u>
FPGA CFG	{Pass/Fail, Unmasked/Masked} Indicates a transmit FPGA configuration failure.
DSP CFG	{Pass/Fail, Unmasked/Masked} Indicates a transmit DSP configuration failure.
SCT CLOCK PLL	{Pass/Fail, Unmasked/Masked} Indicates that the Tx SCT Clock PLL is not locked. This alarm will flash on during certain modem parameter changes. A solid indication points toward a configuration failure within the modem.
SYM CLOCK PLL	{Pass/Fail, Unmasked/Masked} Indicates that the Tx Symbol Clock PLL is not locked. This alarm will flash on during certain modem parameter changes. A solid indication points toward a problem with the incoming clock to the modem (SCTE).
LB SYNTH PLL	{Pass/Fail, Unmasked/Masked} Indicates that the Tx L-Band Synthesizer is not locked. This alarm will flash on during certain modem parameter changes. A solid indication points toward a configuration problem within the modem.
IF SYNTH PLL	{Pass/Fail, Unmasked/Masked} Indicates that the Tx IF Synthesizer is not locked. This alarm will flash on during certain modem parameter changes. A solid indication points toward a configuration problem within the modem.
BUC CURRENT	{Pass/Fail, Unmasked/Masked} Indicates that the BUC current has fallen outside of the threshold limits.
BUC VOLTAGE	{Pass/Fail, Unmasked/Masked} Indicates that the BUC voltage has fallen outside of the threshold limits.
ETHERNET WAN	{Pass/Fail, Unmasked/Masked} Indicates that the interface card is faulted and will not pass data (<i>displays only when the Ethernet Card is installed and the Ethernet Interface is selected</i>).
FORCED ALARM	{DISABLED, ENABLED} Allows user to disable or enable forcing of a Tx Summary Alarm.

TX MINOR (menu)

TERR CLK ACT	{Pass/Fail, Unmasked/Masked} Indicates no Terrestrial Clock activity.
TERR DATA ACT	{Pass/Fail, Unmasked/Masked} Indicates no Tx Data activity.
TX TERR AIS	{Pass/Fail, Unmasked/Masked} Indicates that AIS has been detected in the Tx Data Stream.
DnI FRAME LOCK	{Pass/Fail, Unmasked/Masked} Indicates the framing unit is unable to find the expected terrestrial framing pattern.
DnI M-FRAME LOCK	{Pass/Fail, Unmasked/Masked} Indicates the framing unit is unable to find the expected inter-frame pattern.
DROP CRC	{Pass/Fail, Unmasked/Masked} Indicates if the Circular Redundancy Check is passing in PCM-30C and PCM-31C Modes
TX DVB FRM LOCK	{Pass/Fail, Unmasked/Masked} Indicates that Tx input data stream framing does not match the user selected TX TERR FRAMING.
TX CLK SRC FALLBK	{Pass/Fail, Unmasked/Masked} Indicates that the clock resource has fallen.
TPC CONFLICT CHK	{Pass/Fail, Unmasked/Masked} Indicates that the TPC parameters are not configured correctly.
BUC PLL	{Pass/Fail, Unmasked/Masked} Indicates BUC PLL has failed. (Only available when FSK is enabled)
BUC OVER TEMP	{Pass/Fail, Unmasked/Masked} Indicates that the temperature of the BUC is overtemperature. (Only available when FSK is enabled)
BUC SUMMARY	{Pass/Fail, Unmasked/Masked} Indicates summary alarm. (Only available when FSK is enabled)
BUC OUTPUT	{Pass/Fail, Unmasked/Masked} Indicates that there is no output from the BUC. (Only available when FSK is enabled)
FSK COMMS	{Pass/Fail, Unmasked/Masked} Indicates that the modem has lost communications with the BUC

RX MAJOR (menu)

FPGA CFG	{Pass/Fail, Unmasked/Masked} Indicates a receive FPGA hardware failure.
DSP CFG	{Pass/Fail, Unmasked/Masked} Indicates a receive DSP failure.
SIGNAL LOCK	{Pass/Fail, Unmasked/Masked} Indicates that the demod is unable to lock to a signal.
INPUT LVL THRESH	{Pass/Fail, Unmasked/Masked} Indicates Rx signal level has fallen below input threshold.
FRAME LOCK	{Pass/Fail, Unmasked/Masked} Indicates that the Framing Unit is unable to find the expected framing pattern.
MULTIFRAME LOCK	{Pass/Fail, Unmasked/Masked} This alarm will flash on during certain modem parameter changes. A solid indication points toward a problem with the incoming clock to the modem (SCTE).
LB SYNTH PLL	{Pass/Fail, Unmasked/Masked} Indicates that the Rx L-Band Synthesizer is not locked. This alarm will flash on during certain modem parameter changes. A solid indication points toward a configuration problem within the modem.
IF SYNTH PLL	{Pass/Fail, Unmasked/Masked} Indicates that the Rx IF Synthesizer is not locked. This alarm will flash on during certain modem parameter changes. A solid indication points toward a configuration problem within the modem.
LNB CURRENT	{Pass/Fail, Unmasked/Masked} Indicates that the LNB current has fallen outside of the threshold limits.
LNB VOLTAGE	{Pass/Fail, Unmasked/Masked} Indicates that the LNB voltage has fallen outside of the threshold limits.
ETHERNET WAN	Indicates that the interface card is faulted and will not pass data (<i>displays only when the Ethernet Card is installed and the Ethernet Interface is selected</i>).
FORCED ALARM	{DISABLED, ENABLED} Allows user to enable a forced Rx summary alarm.

RX MINOR (menu)

BUFF UNDERFLOW	{Pass/Fail, Unmasked/Masked} Indicates that a Doppler Buffer underflow has occurred.
BUFF NEAR EMPTY	{Pass/Fail, Unmasked/Masked} Indicates that the Doppler Buffer is about to underflow.
BUFF NEAR FULL	{Pass/Fail, Unmasked/Masked} Indicates that the Doppler Buffer is about to overflow.
BUFF OVERFLOW	{Pass/Fail, Unmasked/Masked} Indicates that a Doppler Buffer overflow has occurred.
RX DATA ACTIVITY	{Pass/Fail, Unmasked/Masked} Indicates that there is no Rx Data activity.
SAT AIS	{Pass/Fail, Unmasked/Masked} Indicates that AIS has been detected in the receive satellite data stream.
DnI FRAME LOCK	{Pass/Fail, Unmasked/Masked} Indicates if drop/insert data is frame locked.
DnI M-FRAME LOCK	{Pass/Fail, Unmasked/Masked} Indicates if drop/insert data has multiframe lock.
INSERT CRC	{Pass/Fail, Unmasked/Masked} Indicates if the Circular Redundancy Check is passing in PCM-30C and PCM-31C Modes.
T1/E1 SIGNALING	{Pass/Fail, Unmasked/Masked} The interface is unable to find the expected signaling information.
IFEC LOCK	{Pass/Fail, Unmasked/Masked} Indicates that the Framing Unit is unable to find the expected framing pattern.
TPC CONFLICT CHK	{Pass/Fail, Unmasked/Masked} Indicates that the TPC parameters are not configured correctly.
OFEC LOCK	{Pass/Fail, Unmasked/Masked} Indicates that the Reed-Solomon Decoder is not locked.
INTERLEAVER	{Pass/Fail, Unmasked/Masked} Indicates that the Reed Solomon Interleaver is not synchronized.
RS UNCORR WORD	{Pass/Fail, Unmasked/Masked} Indicates status of the Reed Solomon uncoded word fault.
EBNO (dB)	{Pass/Fail, Unmasked/Masked} Indicates that the Eb/No are outside of limits.
RX AGC LEVEL	{Pass/Fail, Unmasked/Masked} Indicates if Rx level is below allowable limits.

IBS BER	{Pass/Fail, Unmasked/Masked} Indicates that there are more than one in 1000 bits in error in IBS Mode.
RX DVB FRM LOCK	{Pass/Fail, Unmasked/Masked} Indicates that the Rx Satellite Data Stream Framing is not DVB.
COMMON (menu)	
TERR FPGA CFG	{Pass/Fail, Unmasked/Masked} Indicates an Interface Card FPGA configuration failure.
CODEC FPGA CFG	{Pass/Fail, Unmasked/Masked} Indicates Turbo Codec Card FPGA configuration failure.
CODEC DEV CFG	{Pass/Fail, Unmasked/Masked} Indicates Turbo Codec Card ASIC configuration failure.
EXT CLOCK ACT	{Pass/Fail, Unmasked/Masked} Indicates the External Clock activity.
EXT REF ACT	{Pass/Fail, Unmasked/Masked} Indicates the External Reference activity.
EXT REF LOCK	{Pass/Fail, Unmasked/Masked} Indicates the External Reference PLL is locked detection.
ETHERNET WAN	{Pass/Fail, Unmasked/Masked} Displays the current status of the WAN
VOLTAGES (menu)	
+1.5V RX SUPPLY	{Pass/Fail, Unmasked/Masked} Displays the measured voltage of the 1.5 Volt Rx power bus located inside the modem.
+1.5V TX SUPPLY	{Pass/Fail, Unmasked/Masked} Displays the measured voltage of the 1.5 Volt Tx power bus located inside the modem.
+3.3V SUPPLY	{Pass/Fail, Unmasked/Masked} Displays the measured voltage of the +3.3 Volt power bus located inside the modem.
+5V SUPPLY	{Pass/Fail, Unmasked/Masked} Displays the measured voltage of the +5 Volt power bus located inside the modem.
+12V SUPPLY	{Pass/Fail, Unmasked/Masked} Displays the measured voltage of the +12 Volt power bus located inside the modem.
+20V SUPPLY	{Pass/Fail, Unmasked/Masked} Displays the measured voltage of the +20 Volt power bus located inside the modem.

-12V SUPPLY**{Pass/Fail, Unmasked/Masked}**

Displays the measured voltage of the -20 Volt power bus located inside the modem.

LATCHED ALARMS**{Pass/Fail}**

The following alarms are latched in order to catch intermittent failures:

TX MAJOR (menu)**FPGA CFG****DSP CFG****SCT CLOCK PLL****SYM CLOCK PLL****LB SYNTH PLL****IF SYNTH PLL****BUC CURRENT****BUC VOLTAGE****ETHERNET WAN****TX MINOR (menu)****TERR CLK ACT****TERR DATA ACT****TX TERR AIS****DnI FRAME LOCK****DnI M-FRAME LOCK****DROP CRC****TX DVB FRM LOCK****TX CLKSRC FALLBK****TPC CONFLICT CHK****BUC PLL****BUC OVER TEMP****BUC SUMMARY****BUC OUTPUT****FSK COMMS**

RX MAJOR (menu)**FPGA CFG****DSP CFG****SIGNAL LOCK****INPUT LVL THRESH****FRAME LOCK****MULTIFRAME LOCK****LB SYNTH PLL****IF SYNTH PLL****ETHERNET WAN****LNB CURRENT****LNB VOLTAGE****RX MINOR (menu)****BUFF UNDERFLOW****BUFF NEAR EMPTY****BUFF NEAR FULL****BUFF OVERFLOW****RX DATA ACTIVITY****SAT AIS****DnI FRAME LOCK****DnI M-FRAME LOCK****INSERT CRC****T1/E1 SIGNALING****IFEC LOCK****TPC CONFLICT CHK****OFEC LOCK****INTERLEAVER****RS UNCORR. WORD****TPC IFEC LOCK MISSING****EBNO**

RX AGC LEVEL**RX LEVEL****IBS BER****RX DVB FRM LOCK****COMMON (menu)****TERR FPGA CFG****CODEC FPGA CFG****CODEC DEV CFG****EXT CLOCK ACT****EXT REF ACT****EXT REF LOCK****ETHERNET WAN****VOLTAGE (menu)****+1.5V RX SUPPLY****+1.5V TX SUPPLY****+3.3V SUPPLY****+5V SUPPLY****+12V SUPPLY****-12V SUPPLY****+20V SUPPLY**

CLEAR LATCHED ((ENTER)) Allows the user to reset the latched alarms by pressing <ENTER> on the keypad.

BACKWARD ALARMS The following IBS and IDR Backward alarms only apply if the IDR or IBS options are selected. The IBS and IDR Backward Alarms are transmitted and received from the distant end of the satellite link

NOTE: The following alarms identify the status of the alarms received from the distant satellite end.

IDR1 SAT ALARM 1 {PASS, FAIL}

IDR1 SAT ALARM 2 {PASS, FAIL}

IDR1 SAT ALARM 3	{PASS, FAIL}
IDR1 SAT ALARM 4	{PASS, FAIL}
IBS SAT ALARM	{PASS, FAIL}
T1E1 SATTERR ALM	{PASS, FAIL}
SAT MAP SUMMARY	{NONE, BK 1; BK 2; BK 1&2; BK 3; BK 1&3; BK 2&3; BK 1&2&3; BK 4; BK 1&4; BK 2&4; BK 1&2&4; BK 3&4; BK 1&3&4; BK 2&3&4; BK 1&2&3&4}

Summary alarm is given when criteria meets the selection above.

NOTE:*The following alarms identify the control status of the alarms transmitted to the distant satellite end.*

IDR1 SAT CNTRL	{STNDRD, FRC ON, FRC OFF}
	STNDRD: Set Alarm functions in a normal configuration
	FRC ON: Forces an ON alarm status that is transmitted to the distant end.
	FRC OFF: Forces an OFF alarm status that is transmitted to the distant end.
IDR2 SAT CNTRL	{STNDRD, FRC ON, FRC OFF}
IDR3 SAT CNTRL	{STNDRD, FRC ON, FRC OFF}
IDR4 SAT CNTRL	{STNDRD, FRC ON, FRC OFF}
IBS SAT CNTRL	{STNDRD, FRC ON, FRC OFF}
T1E1 TERR CNTRL	{STNDRD, FRC ON}
IBS TX PROMPT	{STNDRD, FRC ON}
IBS TX SERVICE	{STNDRD, FRC ON}

4.4.7 System Menu Options and Parameters

DATE (MM/DD/YY)	Allows the user to enter the current date.
TIME {HH:MM:SS}	Allows the user to enter the current time.
CONFIG COPY	{Current, CFG1.....CFG10} Allows user to copy, save and recall modem configurations.

FRONT PANEL (menu)

BKLT LEVEL	{OFF, LOW, MED, HIGH} Allows the user to enter the backlight intensity level.
BKLT TIMEOUT	{00 - 99} Allows the user to enter the length of time (in minutes) of keyboard inactivity before the backlight shuts off. 00 = no timeout.
KEY CLICK	{ON, OFF} Allows the user to enable or disable the audible beep each time a key is pressed. Illegal entries will still cause a beep to be heard.
LED TEST	{ENTER} Allows user to test all front panel LEDs.

REMOTE CONTROL

{TERMINAL, COMPUTER}
Allows the user to select between terminal RS-232 control and remote port M&C RS-232/-485 control.

TERMINAL (menu)

TYPE	{VT-100, WYSE50, VIEWPOINT} Allows the user to select the emulation type.
BAUD RATE	{300, 600, 1200, 2400, 4800, 9600, 19200, 38400, 57600, 115200} Allows the user to enter the terminal baud rate.

REMOTE PORT (menu)

ADDRESS	{32 - 255} Allows the user to enter the Remote Port Multidrop Address.
BAUD RATE	{300, 600, 1200, 2400, 4800, 9600, 19200, 38400, 57600, 115200} Allows the user to enter the Remote Port Baud Rate.
INTERFACE	{RS-232, RS-485} Allows the user to enter the Remote Port interface type.

TCP/IP (menu)**BOOT MODE****{DEFAULT, NON-VOL, BOOTP, IP TEST}**

DEFAULT: During initialization (boot up), the modem will restore the web setting to the standard IP Mask and addresses supplied by the modem. The modem will be taken off the network and will not be accessible. The Default settings are:

IP Address Mask:	255.000.000.000	(FF.00.00.00 hex)
Modem IP Address:	010.000.000.001	(C0.A8.00.EE hex)
Server IP Address:	010.001.001.001	(0A.01.01.01 hex)
Router IP Address:	010.000.001.001	(0A.00.01.01 hex)

BOOTP: During initialization (boot up), the modem will get the names, masks, and IP Addresses of the modem, router, and server.

NON-VOL: Stores and uses IP Mask and addresses as provided by the user.

IP TEST: Stores and uses IP Mask and addresses to fixed settings as listed below.

Bootp Server Tag:	206	
IP Address Mask:	255.255.255.000	(FF.FF.FF.00 hex)
Modem IP Address:	192.168.0.238	(C0.A8.00.EE)
Server IP Address:	192.168.000.101	(C0.A8.00.65)
Router IP Address:	192.168.000.102	(C0.A8.00.66)

BOOTp SERVER**{128 – 257, default is 206}**

Only used if Bootp is selected in Boot Mode. Should be consistent with the tag expected by the users Bootp Server.

MODEM HOST

The Host Modem for the network.

IP ADDR MASK

{XXX.XXX.XXX.XXX} Hexidecimal Mask
{ddd.ddd.ddd.ddd} Decimal Mask

The IP Address Mask of the local network. The mask is expressed in a hexadecimal format, and must be a valid TCP/IP Mask. This field should be set before changes are made to the Modem or Router Address.

MODEM IP ADDR

{XXX.XXX.XXX.XXX} Hexidecimal Address
{ddd.ddd.ddd.ddd} Decimal Mask

The IP Address of the modem. This address should be consistent for the mask defined. This address is expressed in hexadecimal format. Broadcast and loop back addresses will not be allowed. These are addresses with all subnet bits set to 0's or 1's.

SERVER IP ADDR **{XXX.XXX.XXX.XXX} Hexidecimal Address**
{ddd.ddd.ddd.ddd} Decimal Address
 The IP Address of the Boot Server and the address of the SNMP Trap Server when SNMP is active. If a server is used and there is no local router, this address must be consistent with the modem address. If a router has been specified, the address is presumed to be reachable via the router. Broadcast and loop back addresses will not be allowed. These are addresses with all subnet bits set to 0's or 1's.

ROUTER IP ADDR **{XXX.XXX.XXX.XXX} Hexidecimal Address**
{ddd.ddd.ddd.ddd} Decimal Address
 The IP Address of the Local Network Router. If a router is present on the local network, this address must be consistent with the IP Mask and the subnet of the modem. If no router is present, then the address should be set to a foreign address. This address is expressed in hexadecimal format.

Broadcast and loop back addresses will not be allowed. These are addresses with all subnet bits set to 0's or 1's.



To change the display for the IP ADDRESS MASK, MODEM IP ADDRESS, SERVER IP ADDRESS, AND ROUTER IP ADDRESS, press all four arrow keys simultaneously.

MODEM EADDR **{001065010000}**
 Displays the Ethernet address of the device. Set at the factory and is a unique identifier for the Ethernet physical interface.

ETHER RATE **{10 MBPS/HD}**
 The data rate for the local Ethernet Interface.
 10 Mbps/HD – for 10 Base-T in either half-duplex or full duplex.

SNMP (menu) A description of OID organization is provided in the MIB portion of this manual (Appendix C).

SNMP VERSION **{V1 & V2, V3}**
 This selection controls the SNMP Version that will be used in messaging between the equipment and its host.

When V1 & V2 is used, RD COMMUNITY and RDWR COMMUNITY are used to determine the authorization of an incoming message.

When V3 is used, three contexts are supported: **public**, **mib2**, and **dev**. Context, Authentication and Privacy are a portion of each SNMPV3 message.

The **public** context will only allow the user to see the sysoid of the unit. This is the most restricted access possible and only allows the unit to be identified by a host SNMP Station.

The **mib2** context allows a user with appropriate authentication to access the mib2 OIDs and the SNMP OIDs. These are of interest primarily to network operators not controlling the satellite link.

The **dev** context allows a user with appropriate authentication to access the device control portion of the MIB. These OIDs are used to control the devices satellite link and operation.

TRAP VERSION	{V1, V2} This controls the type of message format used when a message trap is generated by the equipment and bound for a SNMP Host. Messages will only be sent if the unit has been authorized to do so.
AUTHORIZATION	{TRAPS OFF, TRAPS ON} This controls the type of message format used when a message trap is generated by the equipment and bound for a SNMP host. Messages will only be sent if the unit has been authorized to do so.
RD COMMUNITY	{16 characters of name} This menu is only displayed when SNMP VERSION is set to V1 & V2. This is the community that a host must be acting within when an OID variable is requested by a V1/V2 SNMP message.
RDWR COMMUNITY	{16 characters of name} This menu is only displayed when SNMP VERSION is set to V1 & V2. This is the community that a host must be acting within when an OID variable is being changed by a V1/V2 SNMP message.
TRAP AGENT	{XXX.XXX.XXX.XXX} Hexidecimal Mask {ddd.ddd.ddd.ddd} Decimal Mask IP address of the device receiveing SNMP Traps
FTP (menu)	
PORT	{XXXX} Allows the user to select the desired port number. Factory default is set to 21. Port 21 is a reserved port utilized by the File Transfer Protoco for FTP control traffic.
USER ID	Allows the user to enter the user identification for access to an FTP session.
PASSWORD	Allows the user to enter the password for access to an FTP session.

WEB**CONFIRMATION****{ENABLE, DISABLE}****USER 1****ACCESS GROUP****{NO GROUP, GUEST, OPER, ADMIN}**

Access rights represent the following:

No Group: Denies Access**Guest:** Users are able to navigate most of the site, and view modem parameter settings.**Oper:** Users can monitor and control parameter settings, and change their own authentication passwords.**Admin:** At this highest access right, the users can monitor and control the modems parameters, change any user's name and authentication password, and modify IP network settings. Admin setting allows access to the entire site.**AUTH PASSWORD****{xxxxxxxx}**

User to select password. The user can modify the Authorization Passwords. The user name can have up to 14 characters supporting alpha and numeric characters. Alpha characters can be entered using the up and down arrow keys. Numeric characters can be selected by using the number keys on the front panel. The user can clear all characters from the front panel screen.

USER RESET

Resets group and password.

USER 2**ACCESS GROUP****{NO GROUP, GUEST, OPER, ADMIN}**

Access rights represent the following:

No Group: Denies Access**Guest:** Users are able to navigate most of the site, and view modem parameter settings.**Oper:** Users can monitor and control parameter settings, and change their own authentication passwords.**Admin:** At this highest access right, the users can monitor and control the modems parameters, change any user's name and authentication password, and modify IP network settings. Admin setting allows access to the entire site.**AUTH PASSWORD****{xxxxxxxx}**

User to select password. The user can modify the Authorization Passwords. The user name can have up to 14 characters supporting alpha and numeric characters. Alpha characters can be entered using the up and down arrow keys. Numeric characters can be selected by using the number keys on the

	front panel. The user can clear all characters from the front panel screen.
USER RESET	Resets group and password.
USER 3	
ACCESS GROUP	{NO GROUP, GUEST, OPER, ADMIN}
	Access rights represent the following:
	No Group: Denies Access
	Guest: Users are able to navigate most of the site, and view modem parameter settings.
	Oper: Users can monitor and control parameter settings, and change their own authentication passwords.
	Admin: At this highest access right, the users can monitor and control the modems parameters, change any user's name and authentication password, and modify IP network settings. Admin setting allows access to the entire site.
AUTH PASSWORD	{xxxxxxxx}
	User to select password. The user can modify the Authorization Passwords. The user name can have up to 14 characters supporting alpha and numeric characters. Alpha characters can be entered using the up and down arrow keys. Numeric characters can be selected by using the number keys on the front panel. The user can clear all characters from the front panel screen.
USER RESET	Resets group and password.
HW/FW CONFIG (menu)	
FIRMWARE REV	Displays the installed firmware revision.
M&C REV	Displays the installed Monitor and Control revision.
M&C TIME STAMP	Displays the firmware release date
MAIN BOARD (menu)	



Only the appropriate of the VCO adjustment screens listed below will be displayed. These are protected fields, to prohibit accidental changes. To edit the field, the user must depress all four of the direction arrow keys simultaneously.

INT VCO ADJUST	{0% - 100%} Allows the user to adjust the internal frequency reference for calibration. Only displayed of the system reference clock is INTERNAL.
HI STAB VCO ADJUST	{0% - 100%} Allows the user to adjust the internal frequency reference for calibration. Only displayed if the system reference clock source is HI STABILITY.
LARGEST HB GAP	Used for factory test only.
SOFT RESET	{Enter}
IF BOARD (menu)	Indicates the Radyne part number for the IF Board Assembly.
AGC/CTRL/VALUE	{0% - 100%} Allows the user to adjust the internal frequency reference for calibration. Only displayed if the system reference clock source is HI STABILITY.
I OFFSET	Used for factory test only.
Q OFFSET	Used for factory test only.
IF RX LVL OFFSET	Used for factory test only.
LB RX LVL OFFSET	Used for factory test only.
POWER SOURCE	Used for factory test only.
TERR INTFC BRD	Indicates the Radyne assembly number for the Terrestrial Interface Assembly.
CODEC BOARD (menu)	Indicates the Radyne part number for the Codec Board.
TPC FPGA IMAGE	Used for factory test only.
TPC CODEC IMG	Used for factory test only.
LDPC CODEC IMG	Used for factory test only.
RS FPGA IMAGE	Used for factory test only.
TPC CODEC IMAGE	Used for factory test only.
FRONT PANEL BOARD	Indicates the assembly number for the front panel board.
CNC BOARD (menu)	Indicates the Radyne part number for the CNC Board.
DEBUG MODE	{ENABLED, DISABLED}

CNC DEBUG REGS1 Used for factory test only.
CNC DEBUG REGS2 Used for factory test only.
CNC DEBUG REGS3 Used for factory test only.
CNC DEBUG REGS4 Used for factory test only.
SCALE AMPLTD Used for factory test only.
AR THRESH FACTOR Used for factory test only.
PLL LOOP THRESH Used for factory test only.
ACQ SNTR THRESH Used for factory test only.
PLL LOOP GAIN Used for factory test only.

ODU - BUC (menu) Indicates information from BUC via FSK.

SERIAL NUMBER Indicates the Serial number of the BUC when supplied by the BUC via FSK.

ID INFO Indicates the BUC ID when supplied by the BUC via FSK.

FSK DEBUG IMAGE 0x00D669E5

FEATURES (menu)

5012.2840.2417 {____.____.____}
 Allows the user to install purchased feature upgrades (see Appendix A).
 Contact the Comtech EF Data Customer Service Department or Sales for hardware and software upgrades.

UPGRADE LIST (menu) The following identifies the available upgrade features:

10 MBPS, 20 MBPS(The highest option installed will hide the lower rates.)
RXIF

RXLBAND

TXIF

TXLBAND

ENH ASYNC

IDR

SEQ

RS

RS CUSTOM

IBS

D&I
AUPC
8PSK
16QAM
TURBO 52 MBPS
OM73 SCRAMBLING
DVB
EDMAC

ETH WAN MONITOR
8QAM
LDPC 20 MBPS

4.4.8 Test Menu Options and Parameters

TX TEST PATTERN	{NONE, 2047, 2¹⁵-1, 2²³-1} Allows the user to enable the tests listed above.
RX TEST PATTERN	{NONE, 2047, 2¹⁵-1, 2²³-1} Allows the user to enable the tests listed above.
PATTERN SYNC	{YES, NO} Yes indicates that the RX Test Pattern is in sync.
TST PAT ERR CNT	{NO SYNC, nnnn x 10ⁿ} Displays the number of errors detected by the test pattern checker.
TST PATT BER	{NO SYNC, nnnn x 10ⁿ} Displays the measured BER for the test pattern.
RESTART TST PAT ((ENTER))	Allows the user to restart the test by pressing <ENTER> on the keypad.



IMPORTANT

LOOPBACK WITH ETHERNET DATA INTERFACE

Usage of the modems loopback capabilities in conjunction with the Ethernet data interface can produce undesirable network loops. In order to run any type of data test with an Ethernet interface you must utilize two modems connected back to back. Simply using one modem and a loopback will not produce the desired results.

LOOPBACK	{IF, TERR TX/RX, BASEBAND TX/RX, NONE, TERR RX, BASEBAND RX, TERR TX, BASEBAND TX, IFEC TX} Terrestrial Loopback is performed at the Terrestrial Interface
-----------------	--

IF: IF loopback loops the IF output of the Modulator to the IF input of the Demodulator. If using 8PSK or 16QAM Modulation, the output power must be above -15 dB.

TERR TX/RX: Enables both. Baseband loopback is performed at interface between the Baseband Processor Card and the Modem Card. This ensures Framing/Deframing integrity.

BASEBAND TX/RX: Enables both Baseband Tx and Baseband Rx.

NONE: No loopback performed.

TERR RX: (Distant Loop) Sends received satellite data to the Modulator for transmission to the distant end.

BASEBAND RX: Sends Rx data from the Modem Card to the Tx data input to the Modem Card.

TERR TX: Sends Tx Terrestrial Data to Rx data out.

BASEBAND TX: Sends Tx data to the receive input to the BB Card.

CARRIER TYPE

{NORMAL, CW, DUAL, OFFSET, POS FIR, NEG FIR}
Allows the user to set the type of carrier.

NORMAL: Causes the Modulator to output normal modulation.

CW: Causes the Modulator to output a pure carrier.

DUAL: Causes a double sideband output.

OFFSET: Causes a single sideband output.

POS FIR: For manufacturer's use only.

NEG FIR: For manufacturer's use only.

IQ SAMPLING

{ENABLE/DISABLE}
Allows the user to enable the I & Q pattern on the Web Browser Interface.

IQ SPECTRUM SAMPLING

{ENABLE, DISABLE}
Allows the user to enable the Frequency Spectrum pattern on the Web Browser.

ICMP PING

Used to ping the Router

4.5 Terminal Mode Control

The Terminal Mode Control allows the use of an external terminal or computer to monitor and control the modem from a full screen interactive presentation operated by the modem itself. No external software is required other than VT-100 Terminal Emulation Software (e.g. “Procomm” for a computer when used as a terminal). The Control Port is normally used as an RS-232 Connection to the terminal device. The RS-232 operating parameters can be set using the modem Front Panel and stored in EEPROM for future use (refer to Section 4.7 Terminal Screen Setup).



Refer to the DMD20 Remote Protocol Manual (MN-DMDREMOTEOP) for the terminal screens.

4.5.1 Modem Terminal Mode Control

The modem can be interactively monitored and controlled in the Terminal Mode, with a full screen presentation of current settings and status.

The Terminal Control Mode supports several baud rates, however the connection must be set for 8 data bits, 1 stop bit and no parity (8,N,1). Three terminal emulations are supported: VT-100, WYSE 50, and ADDS-VP.

“\$” is used for setting the screen when the terminal is used for the first time the non-volatile memory is reset.

4.5.2 Modem Setup for Terminal Mode

Terminal Mode Communications and Protocol is set from the Front Panel Control by setting the “Control Mode” Parameter to “Terminal”, and then setting the “Modem Port”, “Term Baud” and “Emulation” Parameters as desired. Then a terminal is connected to Connector J20 on the Back Panel. All operating software for the Terminal Mode is contained within the Modem Internal Control Software.

A “break” signal on the communications line, pressing “ESC” on the terminal or Power On of the modem will initiate full screen terminal mode printing and redraw the full screen. The Terminal Mode displays the present status of all user parameters controlled and read by the processor, and offers a menu allowing change to any controlled parameter.

The Terminal Mode uses eight “Screens,” each of which have the basic contents of the three modem monitor and control areas as set in the Front Panel matrix columns. This screen is used for setting the parameters of the Modulator, Demodulator, Event, Alarm, Latched Alarm, Drop Controls, Insert Controls, and Interface Areas.

4.6 Terminal Port User Interface

The Remote Port (J20) of the modem allows for complete control and monitoring of all parameters and functions via an RS-232 Serial Interface, or RS-485 for RLLP Protocol. 'Terminal Mode' can be entered from the front panel by selecting "System" and then "Control Mode" followed by "Terminal". The baud rate and evaluation type can be changed at the front panel by using the *System>Baud Rate* Menu.

The Terminal Control Mode is menu-driven and the allowable values for each item number will be shown. To change an item, type in its number followed by <ENTER>. If the parameter to be changed requires a numeric value, enter the number followed by <ENTER>. If the parameter is non-numeric, press <SPACE> to cycle through the list of available entries.



Items that do not have ID numbers are Status only and cannot be changed.

4.7 Connecting the Terminal

1. Connect the computer to the Remote Connector (J20) on the rear of the unit using the RS-232 Cable.
2. Enable the terminal by selecting Terminal Mode (located under the System - Control Mode Menu) from the front panel.
3. Verify that your emulation software is set to the following:
 - 8 data bits
 - no parity
 - 1 stop bit

Modify the selection, if necessary, to match the settings (the Front Panel 'SYSTEM' Sub-Menu contains all the Terminal Emulation Controls).

4.8 Terminal Screens



Refer to the DMD20 Remote Protocol Manual (MN-DMDREMOTEOP) for the terminal screens.

Chapter 5. REAR PANEL INTERFACES

This section discusses the electrical interfaces available from the rear panel. All locations are as viewed from the rear of the unit unless otherwise specified.

5.1 DMD20/DMD20 LBST Connections

All DMD20/DMD20 LBST connections are made to labeled connectors located on the rear of the unit (refer to Figure 5-1 for the DMD20 and Figure 5-2 for the DMD20 LBST). The connector definitions below are those on the DMD20/DMD20 LBST unit. Any connection interfacing to the DMD20/DMD20 LBST must be the appropriate mating connector.

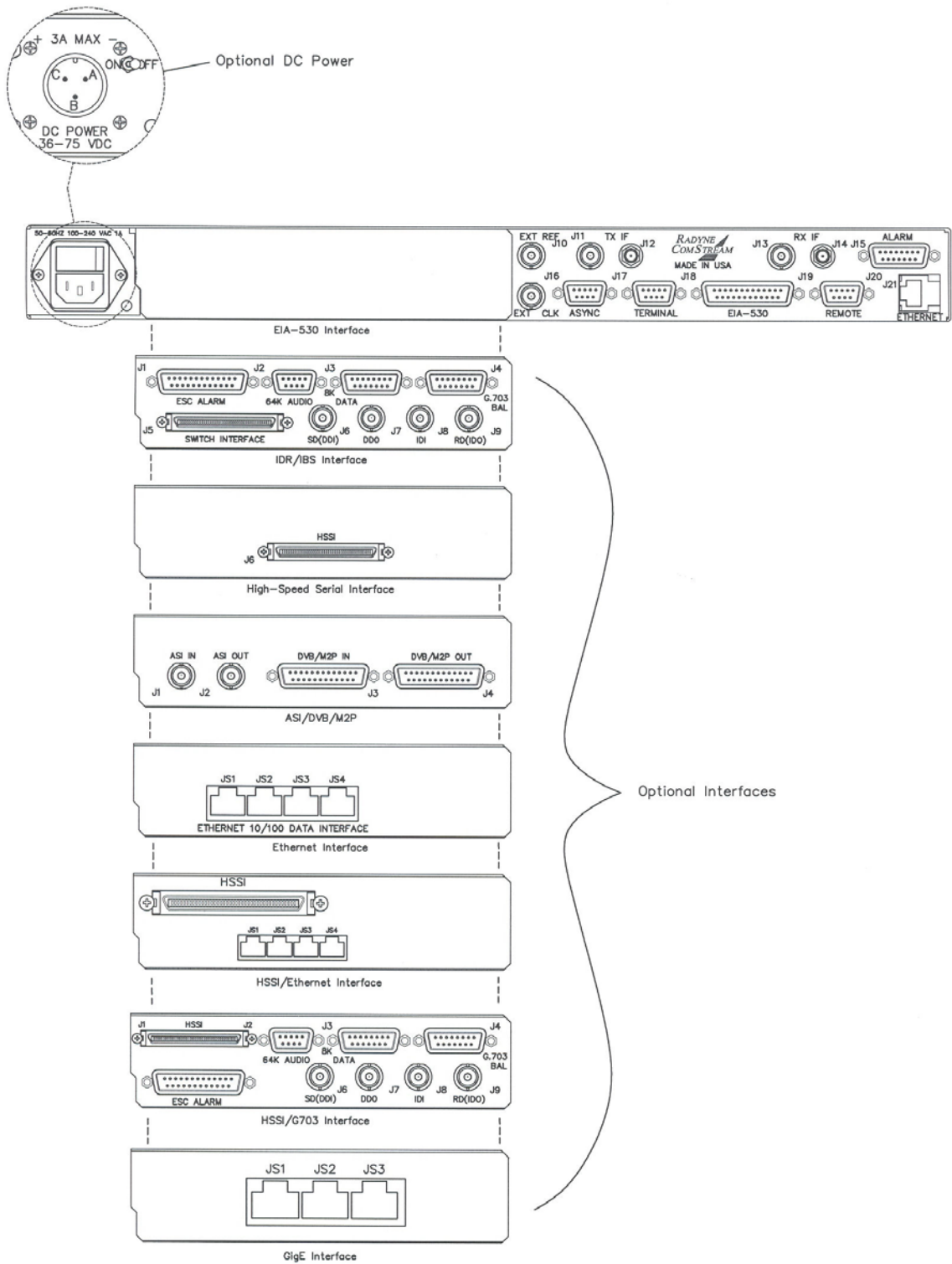

Figure 5-1 DMD20 Universal Satellite Modem Rear Panel Configurations

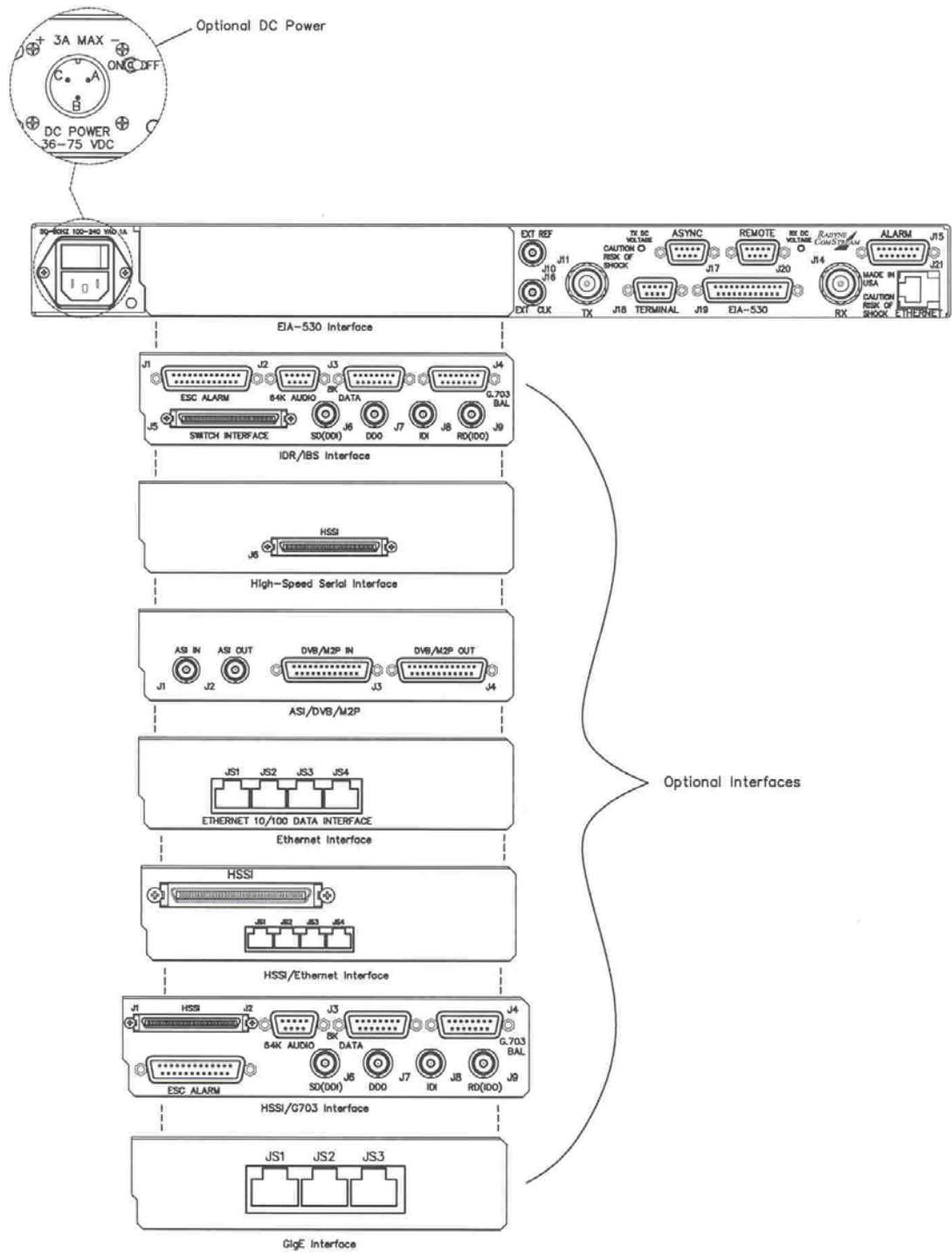

Figure 5-2 DMD20LBST Universal Satellite Modem Rear Panel Configurations

5.2 Compact Flash

The compact flash slot is located on the right side as viewed from the rear of the unit. A 128 or 256 Mbit flash memory card that stores all the modem M&C and operational data. It must be present when the modem is operating.

5.3 Power Input Modules

5.3.1 AC Power Input Module

AC Input Module (Figure 5-1) is located on the left side of the unit. Power applied to the port with the supplied power cable is 100 – 240 VAC, 50 – 60 Hz. Integrated into the Power Input Module is the Power On/Off Rocker Switch. Power consumption for the unit is 1A. A chassis ground connection (#10-32 threaded stud), is located to the lower right of the module .5.2.2 DC Power Input/Switch

The Optional DC Power Input and Switch (Figure 5-1) is available for all DMD20/DMD20 LBST products. The unit may be powered from a 36 – 75 VDC source with a maximum unit power consumption of 3 A. Refer to Table 5-1 for pinouts.

A	–
B	Ground
C	+

5.4 DMD20 Chassis Connections (Standard)

5.4.1 EXT REF (J10)

The External Reference Port is a 50-Ohm Female BNC Connector and will accept the following frequencies: 1.0, 1.544, 2.0, 2.048, 5.0, and 10.0 MHz.

5.4.2 TX IF (J11)

The Transmit IF Output Port is a 75-Ohm Female BNC Connector that is used for 70/140 MHz IF. The power level is programmable from 0 to -25 dBm in 0.1 dBm steps. The IF Frequency can be programmed to 50 – 90 MHz or 100 – 180 MHz, in 1 Hz Steps.

5.4.3 TX L-Band IF (J12)

The Transmit IF Output Port is a 50-Ohm SMA Female Connector that can be used for L-Band IF. The power level is programmable from 0 to -25 dBm, in 0.1 dBm steps. The IF Frequency can be programmed to 950 – 2050 MHz, in 1 Hz Steps.

5.4.4 RX IF

The Receive IF Input Port is a 75-Ohm Female BNC Connector that is used for 70/140 MHz IF. If the customer orders the 70/140 MHz IF, the Transmit IF Output Port is a 75-Ohm Female BNC Connector.

5.4.5 RX L-Band IF

The Receive IF Input Port is a 50-Ohm SMA Female Connector that can be used for L-Band IF. The IF Frequency can be programmed from 950 to 1750 MHz in 1 Hz Steps.

5.4.6 ALARM (J15)

The Alarm Port is a 15-Pin Female “D” Connector. The Alarm port utilizes contact closures to identify the status of the modem. Front panel selections allow the user to select the utilization of the contact closures. Refer to Table 5-2 for pinouts.

Pins 1 through 6 offers form C contacts for Major Alarm Status on the Modulator and Demodulator. When the modem is configured for IBS Network Specification, pins 7-9 only support the IBS Prompt Alarms and pins 10-12 only support IBS Service Alarms.

If the Network specification is configured for Closed Net, the contact closures for Prompt and Service can be utilized to include the summary of all minor alarms or minor/major alarms. This option can be enable via the BB Relays located in the General menu. The IBS Prompt menus can include TX Minor Alarms or TX Minor Alarm and TX Major Alarms. The IBS Service Alarms can include RX Minor Alarms or RX Minor Alarms and RX Major Alarms.

Additional support of the BaseBand relays includes status monitoring of the RTS Carrier. When RTS carrier is enabled and Baseband relay configured for RTS Keyline, the Service alarms pins 10 thru 12 will monitor the status of the RTS signal.

Pin No.	Signal Name	Signal	Direction
1	Mod Fault	MF-C	No Direction
2	Mod Fault	MF-NC	No Direction
3	Mod Fault	MF-NO	No Direction
4	Demod Fault	DF-C	No Direction
5	Demod Fault	DF-NC	No Direction
6	Demod Fault	DF-NO	No Direction
7	Prompt	CEF-C	No Direction
8	Prompt	CEF-NC	No Direction
9	Prompt	CEF-NO	No Direction
10	Service	SP1-C	No Direction
11	Service	SP1-NC	No Direction
12	Service	SP2-NO	No Direction
13	No Connection	SP2-NC	No Direction
14	AGC Out	AGC	No Direction
15	Ground	GND	---

Note 1: Normally open, or Normally closed, conditions indicate a faulted state or off condition.

Note 2: Prompt alarms can be configured to support a summary of a) Prompt alarms, b) Prompt and Tx Minor alarms, or c) Prompt and Tx minor and Tx Major Alarms.

Note 3: Service alarms can be configured to support a summary of a) Service alarms, b) Service and Rx Minor alarms, or c) Service and Rx minor and Rx Major Alarms.

Note 4: Service alarms can be configured to support the RTS Carrier Alarms. Refer to Radyne App Note 230 for addition information on utilizing this feature as Keyline Operation.

5.4.7 EXT CLK (J16)

The External Clock Port is a 75-Ohm Female BNC Connector. It allows interfacing to an external clock source.

5.4.8 ASYNC (J17)

The Asynchronous Data Interface Port is a 9-Pin Female “D” Connector. Refer to Table 5-3 for pinouts.

Table 5-3. ASYNC Port 9-Pin Female “D” Connector (J17)			
Pin No.	Signal Name	Signal	Direction
1	Receive Data B (RS-485)	RXD_B	Output
2	Receive Data A (RS-485/-232)	RXD_A	Output
3	Transmit Data A (RS-485/-232)	TXD_A	Input
4	Transmit Data B (RS-485)	TXD_B	Input
5	Ground	GND	---
6	No Connection	---	---
7	No Connection	---	---
8	No Connection	---	---
9	No Connection	---	---

5.4.9 J18

Comtech EF Data factory use only.

5.4.10 EIA-530 (J19)

The EIA-530 Port is an RS-422/V.35/RS-232 Connection. It is a 25-Pin Female “D” Connector. Refer to Table 5-4 for pinouts.

Table 5-4. EIA-530 Port (RS-422/V.35/RS-232) 25-Pin Female “D” Connector (J19)			
Pin No.	Signal Name	Signal	Direction
1	Shield	---	---
2	Send Data A (-)	SD-A	Input
3	Receive Data A (-)	RD-A	Output
4	Request To Send A (-)	RS-A	Input
5	Clear To Send A (-)	CS-A	Output
6	Data Mode A (-)	DM-A	Output
7	Signal Ground	SGND	---
8	Receiver Ready A (-)	RR-A	Output
9	Receive Timing B (+)	RT-B	Output
10	Receiver Ready B (+)	RR-B	Output
11	Terminal Timing B (+)	TT-B	Input
12	Send Timing B (+)	ST-B	Output
13	Clear T Send B (+)	CS-B	Output
14	Send Data B (+)	SD-B	Input
15	Send Timing A (-)	ST-A	Output
16	Receive Data B (+)	RD-B	Output
17	Receive Timing A (-)	RT-A	Output
18	Modulator Fault - Open Collector	MF	Output
19	Request To Send B (+)	RS-B	Input
20	Data Terminal Ready A (-)	TR-A	Input
21	Demodulator Fault	DF	Output
22	Data Mode B (+)	DM-B	Output
23	Data Terminal Ready B (+)	TR-B	Input
24	Terminal Timing A (-)	TT-A	Input
25	No Connection	---	---

5.4.11 REMOTE (J20)

The Remote Port is a RS-485 or RS-232 Connection for remote monitor and control of the modem. It is a 9-Pin Female “D” Connector. Refer to Table 5-5 for pinouts.

Pin No.	Signal Name	Signal	Direction
1	Transmit Data RS-485 (+)	TX-485-B	Output
2	Transmit Data RS-232	TXD-232	Output
3	Receive Data RS-232	RXD-232	Input
4	NC	NC	---
5	Ground	GND	---
6	Transmit Data RS-485 (-)	TX-485-A	Output
7	NC	No Connection	---
8	Receive Data RS-485 (+)	RX-485-B/CTS	Input
9	Receive Data RS-485 (-)	RX-485-A	Input



IMPORTANT

When operating the remote port as RS232 using a cable pinned 1 for 1 may cause communication failures due to miss routing of standard RS232 com port signals.

When operating the remote port as RS232, the cable used should only have pins 2, 3 and 5 connected.

5.4.12 ETHERNET (J21)

The ETHERNET Port (J21) can be used for the Monitor & Control (M&C) Functions of the unit. The physical interface is a standard female RJ-45 Connector.

Refer to Appendix E and F for proper setup of the TCP-IP interface and Web Browser Setup.

5.5 DMD20 LBST Chassis Connections (Standard)

5.5.1 EXT REF (J10)

The External Reference Port is a 50-Ohm Female BNC Connector and will accept the following frequencies: 1.0, 1.544, 2.0, 2.048, 5.0, and 10.0 MHz). Input level: 0.1Vpp to 5.0Vpp (Sinewave or Squarewave)

5.5.2 TX (J11)

The Transmit Output Port is a 50-Ohm Type-N Connector.

5.5.3 RX (J14)

The Receive Input Port is a 50-Ohm Type-N Connector.

5.5.4 ALARM (J15)

The Alarm Port is a 15-Pin Female “D” Connector. The Alarm port utilizes contact closures to identify the status of the modem. Front panel selections allow the user to select the utilization of the contact closures. Refer to Table 5-2 for pinouts.

Pins 1 through 6 offers form C contacts for Major Alarm Status on the Modulator and Demodulator. When the modem is configured for IBS Network Specification, pins 7-9 only support the IBS Prompt Alarms and pins 10-12 only support IBS Service Alarms.

If the Network specification is configured for Closed Net, the contact closures for Prompt and Service can be utilized to include the summary of all minor alarms or minor/major alarms. This option can be enable via the BB Relays located in the General menu. The IBS Prompt menus can include TX Minor Alarms or TX Minor Alarm and TX Major Alarms. The IBS Service Alarms can include RX Minor Alarms or RX Minor Alarms and RX Major Alarms.

Additional support of the BaseBand relays includes status monitoring of the RTS Carrier. When RTS carrier is enabled and Baseband relay configured for RTS Keyline, the Service alarms pins 10 thru 12 will monitor the status of the RTS signal.

Pin No.	Signal Name	Signal	Direction
1	Mod Fault - C	MF-C	No Direction
2	Mod Fault – NC	MF-NC	No Direction
3	Mod Fault – NO	MF-NO	No Direction
4	Demod Fault - C	DF-C	No Direction
5	Demod Fault – NC	DF-NC	No Direction
6	Demod Fault – NO	DF-NO	No Direction
7	Prompt - C	CEF-C	No Direction
8	Prompt – NC	CEF-NC	No Direction
9	Prompt – NO	CEF-NO	No Direction
10	Service – C	SP1-NO	No Direction
11	Service – NC	SP1-NC	No Direction

Table 5-6. ALARM Port 15-Pin Female “D” Connector (J15)			
Pin No.	Signal Name	Signal	Direction
12	Service – NO	SP2-NO	No Direction
13	No Connection	SP2-NC	No Direction
14	AGC Out	AGC	No Direction
15	Ground	GND	---

Note 1: Normally open, or Normally closed, conditions indicate a faulted state or off condition.

Note 2: Prompt alarms can be configured to support a summary of a) Prompt alarms, b) Prompt and Tx Minor alarms, or c) Prompt and Tx minor and Tx Major Alarms.

Note 3: Service alarms can be configured to support a summary of a) Service alarms, b) Service and Rx Minor alarms, or c) Service and Rx minor and Rx Major Alarms.

Note 4: Service alarms can be configured to support the RTS Carrier Alarms. Refer to Radyne App Note 230 for addition information on utilizing this feature as Keyline Operation.

5.5.5 EXT CLK (J16)

The External Clock Port is a 75-Ohm Female BNC Connector. It allows interfacing to an external clock source. Input level: .5 to 5 volts Peak-to-Peak

5.5.6 ASYNC (J17)

The Asynchronous Data Interface Port is a 9-Pin Female “D” Connector. Refer to Table 5-7 for pinouts.

Table 5-7. ASYNC Port 9-Pin Female “D” Connector (J17)			
Pin No.	Signal Name	Signal	Direction
1	Receive Data B (RS-485)	RXD_B	Output
2	Receive Data A (RS-485/-232)	RXD_A	Output
3	Transmit Data A (RS-485/-232)	TXD_A	Input
4	Transmit Data B (RS-485)	TXD_B	Input
5	Ground	GND	---
6	No Connection	---	---
7	No Connection	---	---
8	No Connection	---	---
9	No Connection	---	---

5.5.7 (J18)

Used for Comtech EF Data factory use only.

5.5.8 EIA-530 (J19)

The EIA-530 Port is an RS-422/V.35/RS-232 Connection. It is a 25-Pin Female “D” Connector. Refer to Table 5-8 for pinouts.

Table 5-8. EIA-530 Port (RS-422/V.35/RS-232) 25-Pin Female “D” Connector (J19)			
Pin No.	Signal Name	Signal	Direction
1	Shield	---	---
2	Send Data A (-)	SD-A	Input
3	Receive Data A (-)	RD-A	Output
4	Request To Send A (-)	RS-A	Input
5	Clear To Send A (-)	CS-A	Output
6	Data Mode A (-)	DM-A	Output
7	Signal Ground	SGND	---
8	Receiver Ready A (-)	RR-A	Output
9	Receive Timing B (+)	RT-B	Output
10	Receiver Ready B (+)	RR-B	Output
11	Terminal Timing B (+)	TT-B	Input
12	Send Timing B (+)	ST-B	Output
13	Clear T Send B (+)	CS-B	Output
14	Send Data B (+)	SD-B	Input
15	Send Timing A (-)	ST-A	Output
16	Receive Data B (+)	RD-B	Output
17	Receive Timing A (-)	RT-A	Output
18	Modulator Fault - Open Collector	MF	Output
19	Request To Send B (+)	RS-B	Input
20	Data Terminal Ready A (-)	TR-A	Input
21	Demodulator Fault	DF	Output
22	Data Mode B (+)	DM-B	Output
23	Data Terminal Ready B (+)	TR-B	Input
24	Terminal Timing A (-)	TT-A	Input
25	No Connection	---	---

5.5.9 REMOTE (J20)

The Remote Port is a RS-485 or RS-232 Connection for remote monitor and control of the modem. It is a 9-Pin Female “D” Connector. Refer to Table 5-9 for pinouts.

Pin No.	Signal Name	Signal	Direction
1	Transmit Data RS-485 (+)	TX-485-B	Output
2	Transmit Data RS-232	TXD-232	Output
3	Receive Data RS-232	RXD-232	Input
4	NC	NC	---
5	Ground	GND	---
6	Transmit Data RS-485 (-)	TX-485-A	Output
7	NC	No Connection	---
8	Receive Data RS-485 (+)	RX-485-B/CTS	Input
9	Receive Data RS-485 (-)	RX-485-A	Input

5.5.10 ETHERNET (J21)

The Ethernet Port (J21) can be used for the Monitor & Control (M&C) Functions of the unit. The physical interface is a standard female RJ-45 Connector.

Refer to Appendix E and F for proper setup of the TCP-IP interface and Web Browser Setup.

5.6 DMD20/DMD20 LBST Optional Data Interfaces

5.7 IDR/IBS Interface (Optional)

Refer to Figures 5-1 and 5-2 for rear panel configurations.

5.8 G.703 IDR/IBS Interface (Optional)

The DMD20 supports G703 IDR/IBS interface. Interface options supported are G703 T1/E1/T2/E2

5.8.1 ESC ALARM (J1)

The ESC (Engineering Service Circuits) Alarms Port is a 25-Pin Female “D” Connector. Refer to Table 5-6 for pinouts.

Table 5-6. ESC ALARM Port 25-Pin Female “D” Connector (J1)			
Pin No.	Signal Name	Signal	Direction
1	Ground	GND	---
2	Backward Alarm Out - 1NO	ESCBWO 1NO	N/A
3	No Connection	NC	---
4	Backward Alarm Out - 2 NO	ESCBWO 2NO	N/A
5	No Connection	NC	---
6	Backward Alarm Out - 3 NO	ESCBWO 3NO	N/A
7	Ground	GND	---
8	Backward Alarm Out - 4 NO	ESCBWO 4NO	N/A
9	No Connection	NC	---
10	Backward Alarm In - 2	ESCBWI 2	Input
11	Backward Alarm In - 4	ESCBWI 4	Input
12	No Connection	NC	---
13	No Connection	NC	---
14	Backward Alarm Out - 1 C	ESCBWO 1C	N/A
15	Backward Alarm Out - 1 NC	ESCBWO 1NC	N/A
16	Backward Alarm Out - 2 C	ESCBWO 2C	N/A
17	Backward Alarm Out - 2 NC	ESCBWO 2NC	N/A
18	Backward Alarm Out - 3 C	ESCBWO 3C	N/A
19	Backward Alarm Out - 3 NC	ESCBWO 3NC	N/A
20	Backward Alarm Out - 4 C	ESCBWO 4C	N/A
21	Backward Alarm Out - 4 NC	ESCBWO 4NC	N/A
22	Backward Alarm In – 1	ESCBWI 1	Input
23	Backward Alarm In – 3	ESCBWI 3	Input
24	No Connection	NC	---
25	No Connection	NC	---

5.8.2 64K AUDIO (J2)

The 64K AUDIO Port allows for communications between Earth Stations. It is a 9-Pin Female “D” Connector that complies with IESS 308. Refer to Table 5-7a for pinouts in audio mode and Table 5-7b for pinouts in 64k mode.

Table 5-7a. 64K AUDIO (In Audio Mode) Port 9-Pin Female “D” Connector (J2)			
Pin No.	Signal Name	Signal	Direction
1	Transmit Audio 1A	ESCAUDTX 1A	Input
2	Receive Audio 1A	ESCAUDRX 1A	Output
3	Ground	GND	---
4	Transmit Audio 2B	ESCAUDTX 2B	Input
5	Receive Audio 2B	ESCAUDRX 2B	Output
6	Transmit Audio 1B	ESCAUDTX 1B	Input
7	Receive Audio 1B	ESCAUDRX 1B	Output
8	Transmit Audio 2A	ESCAUDTX 2A	Input
9	Receive Audio 2A	ESCAUDRX 2A	Output

Table 5-7b. 64K AUDIO (In 64K Mode) Port 9-Pin Female “D” Connector (J2)			
Pin No.	Signal Name	Signal	Direction
1	Send Data A	SD-A	Input
2	Receive Data A	RD-A	Output
3	Ground	GND	---
4	Synchronous Data Send Timing B	ST-B	Input
5	Synchronous Data Receive Timing B	RT-B	Output
6	Send Data B	SD-B	Input
7	Receive Data B	RD-B	Output
8	Synchronous Data Send Timing A	ST-A	Input
9	Synchronous Data Receive Timing A	RT-A	Output

5.8.3 8K DATA (J3)

The 8K Data Port allows for communications between Earth Stations. It is a 15-Pin Female “D” Connector that complies with IESS 308. Refer to Table 5-8 for pinouts.

Table 5-8. 8K DATA Port 15-Pin Female “D” Connector (J3)			
Pin No.	Signal Name	Signal	Direction
1	Receive Octet-B	ESCRXO-B	Output
2	Receive Clock-B	ESCRXC-B	Output
3	Receive Data-B	ESCRXD-B	Output
4	No Connection	NC	---
5	No Connection	NC	---
6	Transmit Data-A	ESCTXD-A	Input
7	Transmit Clock-A	ESCTXC-A	Output
8	Transmit Octet-A	ESCTXO-A	Output
9	Receive Octet-A	ESCRXO-A	Output
10	Receive Clock-A	ESCRXC-A	Output
11	Receive Data-A	ESCRXD-A	Output
12	Ground	GND	---
13	Transmit Data-B	ESCTXD-B	Input
14	Transmit Clock-B	ESCTXC-B	Output
15	Transmit Octet-B	ESCTXO-B	Output

5.8.4 G.703 BAL (J4)

The G.703 Interface Port (Balanced) is a 15-Pin Female “D” Connector. Refer to Table 5-9 for pinouts.

Table 5-9. G.703 BAL Port 15-Pin Female “D” Connector (J4)			
Pin No.	Signal Name	Signal	Direction
1	Send Data (-)	SD-A	Input
2	Ground	GND	---
3	Receive Data A (-)	RD-A	Output
4	Ground	GND	---
5	Drop Data Out (+)	DDO-B	Output
6	Insert Data In (+) EXC (+)	IDI-B	Input
7	External Clock A (-)	BAL EXC-A	Input
8	External Clock B (+)	BAL EXC-B	Input
9	Send Data (+)	SD-B	Input
10	No Connection	---	---
11	Receive Data B (+)	RD-B	Output
12	Drop Data Out (-)	DDO-A	Output
13	Insert Data In (-) EXC (-)	IDI-A	Input
14	Mod Fault	MOD-FLT	Open Collector Output
15	Demod Fault	DMD-FLT	Open Collector Output

5.8.5 SWITCH INTERFACE (J5)

The Switch Interface Port is a 68-Pin High-Density Female Connector. Refer to Table 5-10 for pinouts.

Table 5-10. SWITCH INTERFACE Port 68-Pin High-Density Female Connector (J5)			
Pin No.	Signal Name	Signal	Direction
1	G.703 Send Data Input A	G.703B SD-A	Input
2	Synchronous Data Send Data Input - A	SYNC SD-A	Input
3	IDR ESC Backward Alarm Out - 1 Common	ESCBWO 1C	No Direction
4	G.703 Insert Data Input – A	G.703B IDI-A	Input
5	Synchronous Data Send Timing Output – A	SYNC ST-A	Output
6	IDR ESC Backward Alarm Out - 1 Normally Open	ESCBWO 1NO	No Direction
7	Synchronous Data Terminal Timing Input – A	SYNC TT-A	Input
8	IDR ESC Backward Alarm Out - 2 Normally Closed	ESCBWO 2NC	No Direction
9	G.703 Drop Data Out A - Synchronous Data Receive Timing Output - A	DDO-A RT-A	Output
10	IDR ESC Backward Alarm Output - 3 Common	ESCBWO 3C	No Direction
11	G.703 Insert Data Out A - Synchronous Data Receive Data A	IDO-A RD-A	Output
12	IDR ESC Backward Alarm Output - 3 Normally Open	ESCBWO 3NO	No Direction
13	External Clock Input - A	BAL EXC-A	No Connection
14	Ground	GND	---
15	IDR ESC Audio Input Channel 1A	ESCAUDTX 1A	Input
16	IDR ESC Audio Input Channel 2A	ESCAUDTX 2A	Input
17	IDR ESC Audio Output Channel 1A	ESCAUD RX 1A	Output
18	IDR ESC Audio Output Channel 2A	ESCAUD RX 2A	Output
19	IDR ESC Backward Alarm Input - 3	ESCBWI 3	Input
20	IBS ES Transmit Data A IDR ESC Backward Alarm Input 1	TXD-A BWI 1	Input
21	Mod Fault Open Collector Output	MOD FLT	Output Open Collector
22	IBS ES Receive Data Output - A	ES RXD-A	Output
23	IBS ES Data Set Ready (RS-232 Only)	ES DSR	No Connection

Table 5-10. SWITCH INTERFACE Port 68-Pin High-Density Female Connector (J5)			
Pin No.	Signal Name	Signal	Direction
24	IDR ESC Transmit 8 Kbps Output Clock	ESCTXC-A	Output
25	IDR ESC Transmit 8 Kbps Output Data	ESCTXD-A	Input
26	IDR ESC Receive 8 Kbps Output Clock	ESCRXC-A	Output
27	IDR ESC Receive 8 Kbps Output Data	ESCRXD-A	Output
28	IDR ESC Backward Alarm Output - 4 Normally Closed	ESCBWO 4NC	No Direction
29	IBS Transmit Octet Input - A	TXO-A	Input
30	Synchronous Data Mode A	SYNC DM-A	Output
31	Synchronous Data Clear to Send - A	SYNC CS-A	Output
32	IBS Receive Octet Output - A	RXO-A	Output
33	Synchronous Data Request to Send - A	SYNC RS-A	Input
34	Synchronous Data Receiver Ready - A	SYNC RR-A	Output
35	G.703 Send Data Input - B	G703B SD-B	Input
36	Synchronous Data Send Data Input - B	SYNC SD-B	Input
37	IDR ESC Backward Alarm Out - 1 Normally Closed	ESCBWO 1 NC	No Direction
38	G.703 Insert Data Input - B	G703B IDI-B	Input
39	Synchronous Data Send Timing Output - B	SYNC ST-B	Output
40	IDR ESC Backward Alarm Out - 2 Common	ESCBWO 2C	No Direction
41	Synchronous Data Terminal Timing - B	SYNC TT-B	Input
42	IDR ESC Backward Alarm Output - 2 Normally Open	ESCBWO 2NO	No Direction
43	G.703 Drop Data Out - B Synchronous Data Receive Timing - B	DDO-B RT-B	Output
44	IDR ESC Backward Alarm Out - 3 Normally Closed	ESCBWO 3NC	No Direction
45	G.703 Insert Data Out Synchronous Data	IDO-B RD-B	Output

Table 5-10. SWITCH INTERFACE Port 68-Pin High-Density Female Connector (J5)			
Pin No.	Signal Name	Signal	Direction
46	IDR ESC Backward Alarm Out - 4 Common	ESCBWO 4C	No Direction
47	External Clock Input - B	BAL EXC-B	Input
48	Ground	GND	---
49	IDR ESC Audio Input Channel - 1B	ESCAUDTX 1B	Input
50	IDR ESC Audio Input Channel - 2B	ESCAUDTX 2B	Input
51	IDR ESC Audio Output Channel - 1B	ESCAUDRX 1B	Output
52	IDR ESC Audio Output Channel - 2B	ESCAUDRX 2B	Output
53	IDR ESC Backward Alarm Input - 4	ESCBWI 4	Input
54	IBS ES Transmit Data – B IDR ESC Backward Alarm Input - 2	TX-B BWI 2	Input
55	Demod Fault Open Collector Output	DMD FLT	Output Open Collector
56	IBS ES Receive Data Input - B	ES RXD-B	Output
57	Ground	GND	---
58	IDR ESC Transmit 8 Kbps Output Clock - B	ESCTXC-B	Output
59	IDR ESC Transmit 8 Kbps Output Data - B	ESCTXD-B	Input
60	IDR ESC Receive 8 Kbps Clock Output - B	ESCRXC-B	Output
61	IDR ESC Receive 8 Kbps Data Output - B	ESCRXD-B	Output
62	IDR ESC Backward Alarm Out - 4 Normally Open	ESCBWO 4NO	No Direction
63	IBS Transmit Octet Input - B	TXO-B	Input
64	Synchronous Data – Data Mode Out - B	SYNC DM-B	Output
65	Synchronous Data - Clear to Send - B	SYNC CS-B	Input
66	IBS Receive Octet Output - B	RXO-B	Output
67	Synchronous Data Request to Send – B	SYNC RS-B	Input
68	Synchronous Data Receiver Ready - B	SYNC RR-B	Output

5.8.6 SD (DDI) (J6)

The Send Data (Drop Data In) Port (Unbalanced) is a 75-Ohm Female BNC Connector.

5.8.7 DDO (J7)

The Drop Data Out Port (Unbalanced) is a 75-Ohm Female BNC Connector.

5.8.8 IDI (J8)

The Insert Data In Port (Unbalanced) is a 75-Ohm Female BNC Connector.

5.8.9 SD (IDO) (J9)

The Send Data (Insert Data Out) Port (Unbalanced) is a 75-Ohm Female BNC Connector.

5.9 Ethernet Data Interface (Optional)

The optional modem Ethernet Data Interface provides four RJ-45 10/100 Base-T interface. The Ethernet interface supports Auto-Crossover and Auto-Sensing. The Ethernet port are referred to as JS1 through JS4.

JS1 is Port 1
JS2 is Port 2
JS3 is Port 3
JS4 is Port 4

Refer to Figure 5-1 and 5-2 for outline and Appendix J for setup & configuration.



The DMD20 & 20LBST supports Radyne HDLC and Comtech HDLC modes, offering compatibility with the SLM5650A Bridge Interface.

5.10 High-Speed Serial Interface (HSSI) (Optional)

5.10.1 HSSI (J6)

The HSSI (High-Speed Serial Interface) (J6) complies with the HSSI Functional and Electrical Specifications. The physical interface is a 50-Pin SCSI-2 Type Connector. Electrical levels are ECL. Gapped clocking not supported. The pinouts for this interface are listed in Table 5-11.

Pin No. (+)	Pin No. (-)	Signal Name	Description	Direction
1	26	SG	Signal Ground	---
2	27	RT	Receive Timing	Output
3	28	CA	DCE Available	Output
4	29	RD	Receive Data	Output
6	31	ST	Send Timing (SCT)	Output
7	32	SG	Signal Ground	---
8	33	TA	DTE Available	Input
9	34	TT	Terminal Timing (SCTE)	Input
11	36	SD	Send Data	Input
13	38	SG	Signal Ground	---
14 - 18	39 - 43	5 Ancillary to DCE	Reserved	Input
19	44	SG	Signal Ground	---
20 - 23	45 - 48	4 Ancillary from DCE	Reserved	Output
24	49	TM	Test Mode	Output
25	N/A	MOD_FLT	Alarm	Output
50	N/A	DMD_FLT	Alarm	Output

5.11 ASI/DVB/M2P Interface (Optional)

5.11.1 ASI IN (J1)

The ASI IN Port (J1) is supported on the BNC Connector. The interface complies with DVB ASI Electrical Specifications.

5.11.2 ASI OUT (J2)

The ASI OUT Port (J2) is supported on the BNC Connector. The interface complies with DVB ASI Electrical Specifications.

5.11.3 DVB/M2P IN (J3)

DVB or M2P IN Port (J3) is supported on the DB-25 female connector. It complies with RS-422 Electrical Specifications. Refer to Table 5-12a for DVB and 5-12 b for M2P pinouts for this connector.

Table 5-12a. J3 – DVB In - 25-Pin Female		
Pin Number	Signal Name	Direction
1	CLK+	Input
14	CLK-	Input
2	SYSTEM GND	Input
15	SYSTEM GND	Input
3	D7+	Input
16	D7-	Input
4	D6+	Input
17	D6-	Input
5	D5+	Input
18	D5-	Input
6	D4+	Input
19	D4-	Input
7	D3+	Input
20	D3-	Input
8	D2+	Input
21	D2-	Input
9	D1+	Input
22	D1-	Input
10	D0+	Input
23	D0-	Input
11	DVALID+	Input
24	DVALID-	Input
12	PSYNC+	Input
25	PSYNC-	Input
13	Cable Shield	---

Table 5-12b. J3 – M2P In - 25-Pin Female		
Pin Number	Signal Name	Direction
1	OUTCLK+	Output
14	OUTCLK-	Output
2	CLK+	Input
15	CLK-	Input
3	SYNC+	Input
16	SYNC-	Input
4	VALID+	Input
17	VALID-	Input
5	D0+	Input
18	D0-	Input
6	D1+	Input
19	D1-	Input
7	D2+	Input
20	D2-	Input
8	D3+	Input
21	D3-	Input
9	D4+	Input
22	D4-	Input
10	D5+	Input
23	D5-	Input
11	D6+	Input
24	D6-	Input
12	D7+	Input
25	D7-	Input
13	Cable Shield	---

5.11.4 DVB/M2P OUT (J4)

The DVB or M2P OUT Port (J4) is also supported on the DB-25 Female Connector. It complies with RS-422 Electrical Specifications. Refer to Table 5-13a for DVB and 5-13 b for M2P pinouts for this connector.

Table 5-13a. J3 - DVB Out – 25-Pin Female ‘D’ Sub Connector		
Pin Number	Signal Name	Direction
1	CLK+	Output
14	CLK-	Output
2	SYSTEM GND	Output
15	SYSTEM GND	Output
3	D7+	Output
16	D7-	Output
4	D6+	Output
17	D6-	Output
5	D5+	Output
18	D5-	Output
6	D4+	Output
19	D4-	Output
7	D3+	Output
20	D3-	Output
8	D2+	Output
21	D2-	Output
9	D1+	Output
22	D1-	Output
10	D0+	Output
23	D0-	Output
11	DVALID+	Output
24	DVALID-	Output
12	PSYNC+	Output
25	PSYNC-	Output
13	Cable Shield	---

Table 5-13b. J3 - M2P Out – 25-Pin Female ‘D’ Sub Connector		
Pin Number	Signal Name	Direction
1	NC	Output
14	NC	Output
2	CLK+	Output
15	CLK-	Output
3	SYNC+	Output
16	SYNC-	Output
4	VALID+	Output
17	VALID-	Output
5	D0+	Output
18	D0-	Output
6	D1+	Output
19	D1-	Output
7	D2+	Output
20	D2-	Output
8	D3+	Output
21	D3-	Output
9	D4+	Output
22	D4-	Output
10	D5+	Output
23	D5-	Output
11	D6+	Output
24	D6-	Output
12	D7+	Output
25	D7-	Output
13	Cable Shield	---

5.12 Ethernet Data Interface (Optional)

The optional modem Ethernet Data Interface provides four RJ-45 10/100 Base-T interface. The Ethernet interface supports Auto-Crossover and Auto-Sensing. The Ethernet port are referred to as JS1 through JS4.

JS1 is Port 1
 JS2 is Port 2
 JS3 is Port 3
 JS4 is Port 4

Refer to Figure 5-1 for outline drawings and Appendix J for setup & configuration.



The DMD20 & 20LBST supports Radyne HDLC and Comtech HDLC modes, offering compatibility with the SLM5650A Bridge Interface.

5.13 HSSI / G.703

The HSSI (High-Speed Serial Interface) (J1) complies with the HSSI Functional and Electrical Specifications. The physical interface is a 50-Pin SCSI-2 Type Connector. Electrical levels are ECL. Gapped clocking not supported. The pinouts for this interface are listed in Table 5-14.

Pin No. (+)	Pin No. (–)	Signal Name	Description	Direction
1	26	SG	Signal Ground	---
2	27	RT	Receive Timing	Output
3	28	CA	DCE Available	Output
4	29	RD	Receive Data	Output
6	31	ST	Send Timing (SCT)	Output
7	32	SG	Signal Ground	---
8	33	TA	DTE Available	Input
9	34	TT	Terminal Timing (SCTE)	Input
11	36	SD	Send Data	Input
13	38	SG	Signal Ground	---
14 - 18	39 – 43	5 Ancillary to DCE	Reserved	Input
19	44	SG	Signal Ground	---
20 - 23	45 - 48	4 Ancillary from DCE	Reserved	Output
24	49	TM	Test Mode	Output
25	N/A	MOD_FLT	Alarm	Output
50	N/A	DMD_FLT	Alarm	Output

5.13.1 64K AUDIO (J2)

The 64K AUDIO Port allows for communications between Earth Stations. It is a 9-Pin Female “D” Connector that complies with IESS 308. Refer to Table 5-15a for pinouts in audio mode and Table 5-15b for pinouts in 64k mode.

Table 5-15a. 64K AUDIO (In Audio Mode) Port 9-Pin Female “D” Connector (J2)			
Pin No.	Signal Name	Signal	Direction
1	Transmit Audio 1A	ESCAUDTX 1A	Input
2	Receive Audio 1A	ESCAUDRX 1A	Output
3	Ground	GND	---
4	Transmit Audio 2B	ESCAUDTX 2B	Input
5	Receive Audio 2B	ESCAUDRX 2B	Output
6	Transmit Audio 1B	ESCAUDTX 1B	Input
7	Receive Audio 1B	ESCAUDRX 1B	Output
8	Transmit Audio 2A	ESCAUDTX 2A	Input
9	Receive Audio 2A	ESCAUDRX 2A	Output
Table 5-15b. 64K AUDIO (In 64K Mode) Port 9-Pin Female “D” Connector (J2)			
Pin No.	Signal Name	Signal	Direction
1	Send Data A	SD-A	Input
2	Receive Data A	RD-A	Output
3	Ground	GND	---
4	Synchronous Data Send Timing B	ST-B	Input
5	Synchronous Data Receive Timing B	RT-B	Output
6	Send Data B	SD-B	Input
7	Receive Data B	RD-B	Output
8	Synchronous Data Send Timing A	ST-A	Input
9	Synchronous Data Receive Timing A	RT-A	Output

5.13.2 8K DATA (J3)

The 8K Data Port allows for communications between earth stations. It is a 15-pin female “D” connector that complies with IESS 308. Table 5-16 gives pinouts.

Pin No.	Signal Name	Signal	Direction
1	Receive Octet-B	ESCRXO-B	Output
2	Receive Clock-B	ESCRXC-B	Output
3	Receive Data-B	ESCRXD-B	Output
4	No Connection	NC	---
5	No Connection	NC	---
6	Transmit Data-A	ESCTXD-A	Input
7	Transmit Clock-A	ESCTXC-A	Output
8	Transmit Octet-A	ESCTXO-A	Output
9	Receive Octet-A	ESCRXO-A	Output
10	Receive Clock-A	ESCRXC-A	Output
11	Receive Data-A	ESCRXD-A	Output
12	Ground	GND	---
13	Transmit Data-B	ESCTXD-B	Input
14	Transmit Clock-B	ESCTXC-B	Output
15	Transmit Octet-B	ESCTXO-B	Output

5.13.3 G.703 BAL (J4)

The G.703 Interface Port (Balanced) is a 15-pin female “D” connector. Table 5-17 gives pinouts.

Pin No.	Signal Name	Signal	Direction
1	Send Data (-)	SD-A	Input
2	Ground	GND	---
3	Receive Data A (-)	RD-A	Output
4	Ground	GND	---
5	Drop Data Out (+)	DDO-B	Output
6	Insert Data In (+) EXC (+)	IDI-B	Input
7	External Clock A (-)	BAL EXC-A	Input
8	External Clock B (+)	BAL EXC-B	Input
9	Send Data (+)	SD-B	Input
10	No Connection	---	---
11	Receive Data B (+)	RD-B	Output
12	Drop Data Out (-)	DDO-A	Output
13	Insert Data In (-) EXC (-)	IDI-A	Input
14	Mod Fault	MOD-FLT	Open Collector Output
15	Demod Fault	DMD-FLT	Open Collector Output

5.13.4 ESC ALARM (J5)

The ESC (Engineering Service Circuits) Alarms Port is a 25-Pin Female “D” Connector. Refer to Table 5-18 for pinouts.

Pin No.	Signal Name	Signal	Direction
1	Ground	GND	---
2	Backward Alarm Out - 1NO	ESCBWO 1NO	N/A
3	No Connection	NC	---
4	Backward Alarm Out - 2 NO	ESCBWO 2NO	N/A
5	No Connection	NC	---
6	Backward Alarm Out - 3 NO	ESCBWO 3NO	N/A
7	Ground	GND	---
8	Backward Alarm Out - 4 NO	ESCBWO 4NO	N/A
9	No Connection	NC	---
10	Backward Alarm In - 2	ESCBWI 2	Input
11	Backward Alarm In - 4	ESCBWI 4	Input
12	No Connection	NC	---
13	No Connection	NC	---
14	Backward Alarm Out - 1 C	ESCBWO 1C	N/A
15	Backward Alarm Out - 1 NC	ESCBWO 1NC	N/A
16	Backward Alarm Out - 2 C	ESCBWO 2C	N/A
17	Backward Alarm Out - 2 NC	ESCBWO 2NC	N/A
18	Backward Alarm Out - 3 C	ESCBWO 3C	N/A
19	Backward Alarm Out - 3 NC	ESCBWO 3NC	N/A
20	Backward Alarm Out - 4 C	ESCBWO 4C	N/A
21	Backward Alarm Out - 4 NC	ESCBWO 4NC	N/A
22	Backward Alarm In – 1	ESCBWI 1	Input
23	Backward Alarm In – 3	ESCBWI 3	Input
24	No Connection	NC	---
25	No Connection	NC	---

5.13.5 SD (DDI) (J6)

The Send Data (Drop Data In) Port (Unbalanced) is a 75-Ohm Female BNC Connector.

5.13.6 DDO (J7)

The Drop Data Out Port (Unbalanced) is a 75-Ohm Female BNC Connector.

5.13.7 IDI (J8)

The Insert Data In Port (Unbalanced) is a 75-Ohm Female BNC Connector.

5.13.8 SD (IDO) (J9)

The Send Data (Insert Data Out) Port (Unbalanced) is a 75-Ohm Female BNC Connector.

5.14 HSSI / Ethernet (J1)

The HSSI (High-Speed Serial Interface) (J1) complies with the HSSI Functional and Electrical Specifications. The physical interface is a 50-Pin SCSI-2 Type Connector. Electrical levels are ECL. Gapped clocking not supported. The pinouts for this interface are listed in Table 5-19.

Pin No. (+)	Pin No. (-)	Signal Name	Description	Direction
1	26	SG	Signal Ground	---
2	27	RT	Receive Timing	Output
3	28	CA	DCE Available	Output
4	29	RD	Receive Data	Output
6	31	ST	Send Timing (SCT)	Output
7	32	SG	Signal Ground	---
8	33	TA	DTE Available	Input
9	34	TT	Terminal Timing (SCTE)	Input
11	36	SD	Send Data	Input
13	38	SG	Signal Ground	---
14 - 18	39 – 43	5 Ancillary to DCE	Reserved	Input
19	44	SG	Signal Ground	---
20 - 23	45 - 48	4 Ancillary from DCE	Reserved	Output
24	49	TM	Test Mode	Output
25	N/A	MOD_FLT	Alarm	Output
50	N/A	DMD_FLT	Alarm	Output

5.15 Ethernet Data Interface

The optional Ethernet Data Interface provides four RJ-45 10/100 Base-T interface. The Ethernet interface supports Auto-Crossover and Auto-Sensing. The Ethernet port are referred to as JS1 through JS4.

JS1 is Port 1

JS2 is Port 2

JS3 is Port 3

JS4 is Port 4

Refer to Figure 5-1 and 5-2 for outline and Appendix J for setup & configuration.

See [Note 1](#).

5.16 GigE Interface

The optional Ethernet Data Interface provides a three port RJ45 10/100/1000 Base-T Interface. The Ethernet interface supports Auto-Crossover and Auto-Sensing. The Ethernet port are referred to as JS1 through JS4 or JS1 through JS3. Refer to Figures 5-1 and 5-2 for rear panel configurations.

JS1 is Port 1
JS2 is Port 2
JS3 is Port 3

Refer to Figure 5-1 and 5-2 for outline and Appendix J for setup & configuration.

See [Note 1](#).



Note 1 **The DMD20 & 20LBST supports Radyne HDLC and Comtech HDLC modes, offering compatibility with the SLM5650A Bridge Interface.**

Chapter 6. MAINTENANCE AND TROUBLESHOOTING

This section discusses unit maintenance and troubleshooting for the Universal Satellite Modem.



The DMD20/DMD20 LBST contains a Lithium Battery.

DANGER OF EXPLOSION exists if the battery is incorrectly replaced. Replace only with the same or equivalent type recommended by the manufacturer. Dispose of used batteries in accordance with local and national regulations.

6.1 Periodic Maintenance

There is no external fuse on the modem. The fuse is located on the power supply assembly inside the case, and replacement is not intended in the field.

6.1.1 Clock Adjustment

The modem allows for VCO speed adjustment from the front panel. Clock adjustment should be performed only when an internal clock source has insufficient accuracy for the custom modem application.

6.2 Troubleshooting

Should a unit be suspected of a defect in field operations after all interface signals are verified, the correct procedure is to replace the unit with another known working unit. If this does not cure the problem, wiring or power should be suspect.

The following is a brief list of possible problems that could be caused by failures of the modem or by improper setup and configuration for the type of service. The list is arranged by possible symptoms exhibited by the modem.

Symptom	Possible Cause
The Modem will not acquire the incoming carrier:	There is an improper receive input to modem.
	The Receive Carrier Level is too low.
	The Receive Carrier Frequency is outside of the acquisition range.
	The Transmit Carrier is incompatible.
	Modem is in Test Mode.
The Async Port is not configured correctly.	The switches may not be set in the correct positions.

6.2.1 Alarm Faults

6.2.1.1 Major Tx Alarms

Alarm	Possible Cause
FPGA CFG	Indicates a transmit FPGA hardware failure.
DSP CFG	Indicates a transmit FPGA failure.
SCT Clock PLL	Indicates that the Tx SCT Clock PLL is not locked. This alarm will flash on during certain modem parameter changes. A solid indication points toward a configuration problem within the modem.
SYM Clock PLL	Indicates that the Tx Symbol Clock PLL is not locked. This alarm will flash on during certain modem parameter changes. A solid indication points toward a problem with the incoming clock to the modem (SCTE).
LB Synth PLL	Indicates that the Tx L-Band Synthesizer is not locked. This alarm will flash on during certain modem parameter changes. A solid indication points toward a configuration problem within the modem.
IF Synth PLL	Indicates that the Tx IF Synthesizer is not locked. This alarm will flash on during certain modem parameter changes. A solid indication points toward a configuration problem within the modem.
Ethernet WAN	Indicates that the WAN Port is down.

6.2.1.2 Major Rx Alarms

Alarm	Possible Cause
FPGA CFG	Indicates a receive FPGA hardware failure.
DSP CFG	Indicates a receive DSP failure.
SIGNAL LOCK	Indicates that the demod is unable to lock to a signal.
FRAME LOCK	Indicates that the Framing Unit is unable to find the expected framing pattern.
MULTIFRAME LOCK	Indicates that the Framing Unit is unable to find the expected framing pattern.
LB SYNTH PLL	Indicates that the Rx L-Band Synthesizer is not locked. This alarm will flash on during certain modem parameter changes. A solid indication points toward a configuration problem within the modem.
IF SYNTH PLL	Indicates that the Rx IF Synthesizer is not locked. This alarm will flash on during certain modem parameter changes. A solid indication points toward a configuration problem within the modem.
Ethernet WAN	Indicates that the WAN Port is down.

6.2.1.3 Minor Tx Alarms

Alarm	Possible Cause
TERR CLK ACT	Indicates no Terrestrial Clock activity.
TERR DATA ACT	Indicates no Tx Data activity.
TX TERR AIS	Indicates that AIS has been detected in the Tx Data Stream.
DnI FRAME LOCK	When running Drop Mode, indicates that the framing unit is unable to find the exported terrestrial framing pattern.
DnI M-FRAME LOCK	When running Drop Mode, indicates that the framing unit is unable to find the exported terrestrial framing pattern.
TX DVB FRAME LOCK	Indicates that the Tx Input Data Stream Framing does not match the user selected Tx Terr Framing. Incorrect Tx Terr Framing selected. Incorrectly framed Tx Input Data Stream.
BUC CURRENT	Indicates that current is either below or above the threshold limits of the LNB, as specified by the modem. Only active when voltage is enabled.
BUC VOLTAGE	Indicates that the voltage is not functioning correctly when voltage is enabled.

6.2.1.4 Minor Rx Alarms

Alarm	Possible Cause
BUFF UNDERFLOW	Indicates that a Doppler Buffer underflow has occurred.
BUFF NEAR EMPTY	Indicates that the Doppler Buffer is about to underflow.
BUFF NEAR FULL	Indicates that the Doppler Buffer is about to overflow.
BUFF OVERFLOW	Indicates that a Doppler Buffer overflow has occurred.
RX DATA ACTIVITY	Indicates that there is no Rx Data activity. For the Ethernet Interface, indicates that no Ethernet port is active (no cable is plugged in).
SAT AIS	Indicates that AIS has been detected in the receive satellite data stream.
DnI FRAME LOCK	Indicates if drop/insert data is frame locked.
DnI M-FRAME LOCK	Indicates if drop/insert data has multiframe lock.
INSERT CRC	Indicates if the Circular Redundancy Check is passing in PCM-30C and PCM-31C Modes.
T1/E1 SIGNALING	Indicates that the T1/E1 Signal is not locked.
IFEC LOCK	Indicates that the Inner Codec is not locked.
OFEC LOCK	Indicates that the Reed-Solomon Decoder is not locked.
INTERLEAVER	Indicates that the Reed Solomon Interleaver is not synchronized.
EBNO (dB)	Indicates that the Eb/No is outside of limits.
IBS BER	Indicates that there are more than one in 1000 bits in error in IBS mode.
RX DVB FRAME LOCK	Indicates that the Rx Satellite Data Stream Framing is not DVB.
LNB CURRENT	Indicates that current is either below or above the threshold limits of the BUC, as specified by the modem. Only active when voltage is enabled.
LNB VOLTAGE	Indicates that voltage is not functioning correctly when voltage is enabled.

6.2.1.5 Drop and Insert Alarms

Alarm	Possible Cause
Multiframe Lock	The insert framer is not in sync.
CRC Lock	An Insert CRC Fault occurred. Valid in T1-ESF, PCM-30, or PCM-30C Modes.
T1 Signaling	An Insert T1 Yellow Fault occurred. Valid in T1-ESF, T1D4, or SCL-96 Modes.
E1 FAS (E1 Frame Acquisition Sync)	An E1 FAS Fault occurred. Valid in PCM-30, or PCM-30C, PCM-31, or PCM-31C Modes.
E1 MFAS (E1 Multi-Frame Acquisition Sync)	An E1 MFAS Fault occurred. Valid in PCM-30, or PCM-30C, PCM-31, or PCM-31C Modes.

6.2.1.6 Common Major Alarms

Alarm	Possible Cause
TERR FPGA CFG	Indicates an Interface Card FPGA configuration failure probably caused by a missing, or wrong file.
CODEC FPGA CFG	Indicates Turbo Codec Card FPGA configuration failure probably caused by a missing, or wrong file.
+1.5V RX SUPPLY	Displays the measured voltage of the 1.5 Volt Rx power bus located inside the modem.
+1.5V TX SUPPLY	Displays the measured voltage of the 1.5 Volt Tx power bus located inside the modem.
+3.3V SUPPLY	Displays the measured voltage of the +3.3 Volt power bus located inside the modem.
+5V SUPPLY	Displays the measured voltage of the +5 Volt power bus located inside the modem.
+12V SUPPLY	Displays the measured voltage of the +12 Volt power bus located inside the modem.
+20V SUPPLY	Displays the measured voltage of the +20 Volt power bus located inside the modem.
EXT CLOCK ACT	Indicates that the External Clock is not active.
EXT REF ACT	Indicates no activity on the External Reference.
EXT REF LOCK	Indicates that the External Reference PLL is not locked.

6.2.2 Alarm Masks

The modem performs a high degree of self-monitoring and fault isolation. The alarms for these faults are separated into the following three categories:

- Active Alarms
- Common Equipment Alarms
- Backward Alarms

A feature exists that allows the user to 'Mask' out certain alarms as explained below.



Masking alarms may cause undesirable modem performance .

When an alarm is masked, the Front Panel LEDs and the Fault Relays do not get asserted, but the Alarm will still be displayed. This feature is very helpful during debugging or to lock out a failure of which the user is already aware.

6.2.2.1 Active Alarms

6.2.2.1.1 Major Alarms

Major Alarms indicate a modem hardware failure. Major Alarms may flash briefly during modem configuration changes and during power-up but should not stay illuminated. Alarms are grouped into Transmit and Receive Alarms - Transmit and Receive are completely independent.

6.2.2.1.2 Minor Alarms

Minor Alarms indicate that a problem may persist outside the modem such as loss of Terrestrial Clock, loss of terrestrial data activity, or a detected transmit or receive AIS condition. Alarms are grouped into Transmit and Receive Alarms - Transmit and Receive are completely independent.

6.2.2.1.3 Common Equipment Faults

Common equipment faults indicate hardware or configuration problems in the modem that effect both transmit and receive operation. Most common faults indicate a hardware failure within the modem, such as a bad power supply. Common faults for the External Reference and External Clock indicate a bad modem configuration, not a hardware failure.

6.2.2.2 Latched Alarms

Latched Alarms are used to catch intermittent failures. If a fault occurs, the fault indication will be latched even if the alarm goes away. After the modem is configured and running, it is recommended that the Latched Alarms be cleared as a final step.

6.2.2.3 Backward Alarms

Backward Alarms are alarms that are fed back to or received from the other end of the satellite link. In IBS Mode (including Drop & Insert), Backward Alarm 1 is the only one used. It would be received if the distant end demod drops lock.

6.3 IBS Fault Conditions and Actions

Figure 6-1 and Table 6-1 illustrate the IBS Fault Conditions and Actions to be taken at the Earth Station, at the Terrestrial Data Stream, and the Satellite. These faults include those detected on the Terrestrial link and those detected from the satellite.

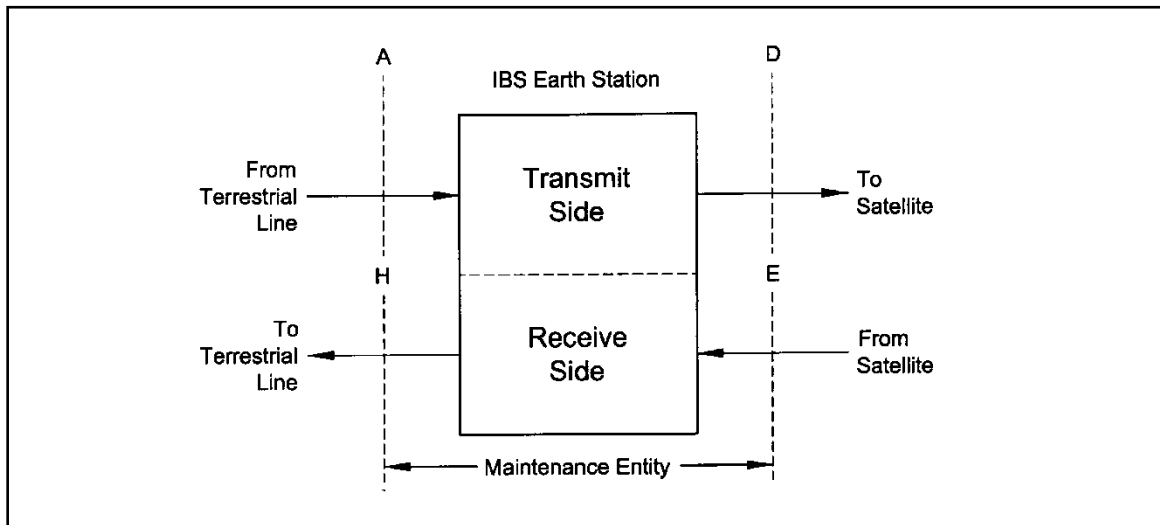

Figure 6-1 IBS Alarm Concept

Table 6-1. IBS Fault Conditions and Actions (includes Drop and Insert)			
Fault Detected on Terrestrial Link (Across Interface A)	Action In Earth Station	Action to Terrestrial (Across Interface H)	Action to Satellite (Across Interface D)
FA1 - Loss of Terrestrial Input	AS1, 2 - IBS Prompt, Service Alarm	AH2 - '1' in Bit 3 of NFAS TSO, Yellow Alarm	AD1 - AIS in Relevant TSs
FA2 - Loss of Terrestrial Signaling	AS1 - - IBS Prompt Alarm	AH2 - '1' in Bit 3 of NFAS TSO, Yellow Alarm	AD3 - '1111' in Relevant TS16's
FA3 - Loss of Terrestrial Frame	AS1 - - IBS Prompt Alarm	AH2 - '1' in Bit 3 of NFAS TSO, Yellow Alarm	AD1 - AIS in Relevant TSs
FA4 - Loss of Terrestrial Multiframe	AS1 - IBS Prompt Alarm	AH2 - '1' in Bit 3 of NFAS TSO, Yellow Alarm	AD3 - '1111' in Relevant TS16's
FA5 - BER of 1×10^{-3} or Greater on Terrestrial Input	AS1 - IBS Prompt Alarm	AH2 - '1' in Bit 3 of NFAS TSO, Yellow Alarm	AD1 - AIS in Relevant TSs
FA6 - Alarm Indication Received on Terrestrial Input	---	---	AD2 - '1' in Bit 3 of Byte 32
Fault Detected From Satellite (Across Interface E)			
FA1 - Loss of Satellite Signal Input	AS1, 2 - IBS Prompt, Service Alarm	AH1, 3 - AIS in TSs, '1111' in TS16	AD2 - '1' in Bit 3 of Byte 32
FA2 - Loss of Satellite Frame	AS1, 2 - IBS Prompt, Service Alarm	AH1, 3 - AIS in TSs, '1111' in TS16	AD2 - '1' in Bit 3 of Byte 32
FA3 - Loss of Satellite Multiframe	AS1, 2 - IBS Prompt, Service Alarm	AH1, 3 - AIS in TSs, '1111' in TS16	AD2 - '1' in Bit 3 of Byte 32
FA4 - BER of 1×10^{-3} or Greater From Satellite Input	AS1, 2 - IBS Prompt, Service Alarm	AH1, 3 - AIS in TSs, '1111' in TS16	AD2 - '1' in Bit 3 of Byte 32
FA5 - Alarm Indication Received From Satellite Input	AS2 - IBS Service Alarm	AH2 - '1' in Bit 3 of NFAS TSO, Yellow Alarm	---

Chapter 7. TECHNICAL SPECIFICATIONS

7.1 Data Rates

Refer to Section 7.18.

7.2 Modulator

Modulation	BPSK, QPSK, and OQPSK (8PSK, 16QAM Optional)
IF Tuning Range	50 to 90, 100 to 180 MHz in 1 Hz Steps
L-Band Tuning Range	950 to 2050 MHz in 1 Hz Steps
Impedance	IF, 75-Ohm (50-Ohm Optional) L-Band, 50-Ohm
Connector	BNC, 75-Ohm SMA, 50-Ohm, L-Band or N-type, 50-Ohm LBST
Return Loss	IF, 20 dB Minimum L-Band, 14 dB Minimum
Output Power	0 to -25 dB
Output Stability	IF: ± 0.5 dB Over Time and Temperature L-Band: ± 1.0 dB Over Time and Temperature
Output Spectrum	Meets IESS 308/309/310 Power Spectral Mask
Spurious	-50 dBc In-Band (50 to 90 MHz, 100 to 180 MHz, 950 to 2050 MHz) -45 dBc Out-of-Band
On/Off Power Ratio	>60 dB
Scrambler	CCITT V.35 or IBS (Others Optional)
FEC	Viterbi, {1/2, 3/4, 7/8, None} K = 7 Sequential {1/2, 3/4, 7/8} CSC {3/4} Trellis (8PSK) {2/3} DVB VIT {1/2, 2/3, 3/4, 5/6, 7/8} DVB Trellis {2/3, 3/4, 5/6, 7/8, 8/9}
	Turbo Product Code (Optional) – (SuperCard ONLY)
	Turbo (BPSK) {21/44, 5/16}
	Turbo (OQPSK/QPSK) {1/2, 3/4, 7/8}
	Turbo (8PSK) {3/4, 7/8}
	Turbo (16QAM) {3/4, 7/8}
	Legacy Turbo Rates {0.495, 0.793} < 5Mbps

	LDPC/TPC (Optional)	
	LDPC (BPSK)	{1/2}
	LDPC (OQPSK/QPSK)	{1/2, 2/3, 3/4}
	LDPC (8PSK/8QAM)	{2/3, 3/4}
	LDPC (16QAM)	{3/4}
	Turbo (BPSK)	{21/44}
	Turbo (QPSK/OQPSK)	{1/2, 2/3, 3/4, 7/8}
	Turbo (8QAM/8PSK)	{2/3, 3/4, 7/8}
	Turbo (16QAM)	{3/4, 7/8}
Outer Encoder Options	Reed-Solomon INTELSAT (DVB Optional, Custom Rates Optional)	
Data Clock Source	Internal, External, Rx Recovered	
Internal Stability	1 x 10 ⁻⁶ Typical (Optional to 5 x 10 ⁻⁸) DMD20 5 x 10 ⁻⁸ Typical DMD20 LBST	

7.3 Demodulator

Demodulation	BPSK, QPSK, and OQPSK (8PSK, 16QAM Optional)	
IF Tuning Range	50 to 90, 100 to 180 MHz in 1 Hz Steps	
L-Band Tuning Range	950 to 2050 MHz in 1 Hz Steps	
Impedance	IF, 75-Ohm (50-Ohm optional)	
	L-Band, 50-Ohm	
Connector	BNC - 75 Ohm SMA - 50 Ohm N-type 50-Ohm LBST	
Return Loss	IF, 20 dB Minimum SMA, 50-Ohm, L-Band L-Band, 14 dB Minimum	
Spectrum	INTELSAT IESS 308/309/310 Compliant	
Input Level	10 x log (Symbol Rate) - 100, ±12 dB	
Adjacent Channel Rejection Ratio	>+10 dBc	
Total Input Power	-10 dBm or +40 dBc (the Lesser) @ 256 Kbps	
FEC	Viterbi	{1/2, 3/4, 7/8, None} K = 7
	Sequential	{1/2, 3/4, 7/8}
	CSC	{3/4}
	Trellis (8PSK)	{2/3}
	DVB VIT	{1/2, 2/3, 3/4, 5/6, 7/8}
	DVB Trellis	{2/3, 3/4, 5/6, 7/8, 8/9}
	Turbo Product Code (Optional) – (SuperCard ONLY)	
	Turbo (BPSK)	{21/44, 5/16}
	Turbo (OQPSK/QPSK)	{1/2, 3/4, 7/8}
	Turbo (8PSK)	{3/4, 7/8}
	Turbo (16QAM)	{3/4, 7/8}
	Legacy Turbo Rates	{0.495, 0.793} < 5Mbps
	LDPC/TPC (Optional)	
	LDPC (BPSK)	{1/2}
	LDPC (OQPSK/QPSK)	{1/2, 2/3, 3/4}
	LDPC (8PSK/8QAM)	{2/3, 3/4}
	LDPC (16QAM)	{3/4}
	Turbo (BPSK)	{21/44}
	Turbo (QPSK/OQPSK)	{1/2, 2/3, 3/4, 7/8}
	Turbo (8QAM/8PSK)	{2/3, 3/4, 7/8}
	Turbo (16QAM)	{3/4, 7/8}

Decoder Options	Reed-Solomon INTELSAT (DVB Optional, Custom Rates Optional)
Descrambler	CCITT V.35 or IBS (Others Optional)
Acquisition Range	Programmable ± 1 kHz to ± 255 kHz
Sweep Delay Value	100 msec to 6000 sec. in 100 msec Steps

7.4 Plesiochronous Buffer

Size	0 msec to 64 msec
Centering	Automatic on Underflow/Overflow
Centering Modes	IBS: Integral Number of Frames IDR: Integral Number of Multi Frames
Clock	Transmit, External, Rx Recovered or SCT (Internal)

7.5 Monitor and Control

Remote RS-485/Terminal RS-232/Ethernet 10 Base-T/Web Browser,
DMD15 Protocol Compatible

7.6 DMD20/DMD20 LBST Drop and Insert (Optional)

Terrestrial Data	1.544 Mbps or 2.048 Mbps, G.732/733
Line Coding	AMI or B8ZS for T1 and HDB3 for E1
Framing	D4, ESF and PCM-30 (PCM-30C) or PCM-31 (PCM-31C) for E1
Time Slot Selection	n x 64 Contiguous or Arbitrary Blocks for Drop or Insert.
Time Slots	TS1, 2, 3, 4, 5, 6, 8, 10, 12, 15, 16, 20, 24, 30, 31
Data Rates	64, 128, 192, 256, 320, 384, 512, 640, 768, 960, 1024, 1280, 1536, 1920 Kbps
Efficient D&I Time Slots	Closed Network, Satellite Overhead 0.4% 1-31 Any combination

7.7 Terrestrial Interfaces

A variety of standard interfaces are available for the DMD20/DMD20 LBST modem in stand-alone applications.

7.8 IDR/ESC Interface (Optional)

G.703 T1 (DSX1)	1.544 Mbps, 100-Ohm Balanced, AMI and B8ZS
G.703 E1	2.048 Mbps, 75-Ohm Unbalanced and 120-Ohm Balanced, HDB3
G.703 T2 (DSX2)	6.312 Mbps, 75-Ohm Unbalanced and 110-Ohm Balanced, B8ZS and B6ZS
G.703 E2	8.448 Mbps, 75-Ohm BNC, Unbalanced, HDB3

7.9 IBS/Synchronous Interface (Standard)

RS-422/-530	All Rates, Differential, Clock/Data, DCE
ITU V.35	All Rates, Differential, Clock/Data, DCE
RS-232	(DCE up to 200 Kbps)

7.10 High-Speed Serial Interface (HSSI)

HSSI: HSSI, Serial, 50-Pin SCSI-2 Type Connector (Female)

7.11 ASI

ASI/RS-422 Parallel: ASI, Serial, 75-Ohm BNC (Female)
DVB/M2P, Parallel, RS-422, DB-25 (Female)

ASI/LVDS Parallel: ASI, Serial, 75-Ohm BNC (Female)
DVB/M2P, Parallel, LVDS, DB-25 (Female)

7.12 DVB/M2P

DVB/M2P: DB-25 Female Connector. It complies with RS-422 Electrical Specifications.

7.13 Ethernet Data Interface (Optional)

Ethernet Data Interface Four RJ-45, Auto-Crossover, Auto-Sensing, 10/100 Ethernet Data Ports. Complies with IEEE 802.3 and IEEE 802.3u.

7.14 Giga Ethernet Data Interface (Optional)

Ethernet Data Interface Three RJ-45, Auto-Crossover, Auto-Sensing, 10/100/1000 Ethernet Data Ports. Complies with IEEE 802.3 and IEEE 802.3u.

7.15 HSSI / G703

HSSI High-Speed Serial Interface, 50-pin SCSI-2 Type Connector (Female)

G.703 T1 (DSX1) 1.544 Mbps, 100-Ohm Balanced, AMI and B8ZS

G.703 E1 2.048 Mbps, 75-Ohm Unbalanced and 120-Ohm Balanced, HDB3

G.703 T2 (DSX2) 6.312 Mbps, 75-Ohm Unbalanced and 110-Ohm Balanced, B8ZS and B6ZS

G.703 E2 8.448 Mbps, 75-Ohm BNC, Unbalanced, HDB3

Note: Does not support backward alarms

7.16 HSSI /ETHERNET

HSSI HSSI, High-Speed Serial Interface, 50-pin SCSI-2 Type Connector (Female)

Ethernet Data Interface Four RJ-45, Auto-Crossover, Auto-Sensing, 10/100 Ethernet Data Ports. Complies with IEEE 802.3 and IEEE 802.3u.

7.17 Environmental

Prime Power	100 to 240 VAC, 50 to 60 Hz, 40 Watts Maximum 48 VDC (Optional)
Operating Temperature	0 to 50°C, 95% Humidity, Non-Condensing
Storage Temperature	-20 to 70°C, 99% humidity, Non-Condensing

7.18 Physical

	DMD20	DMD20 LBST
Size	19" W x 16" D x 1.75" H (48.26 x 40.64 x 4.45 cm)	19" W x 19.25" D x 1.75" H (48.26 x 48.89 x 4.45 cm)
Weight	6.5 Pounds (3.0 Kg)	8.5 pounds (3.83 kg)

7.19 DMD20/DMD20 LBST Data Rate Limits

7.19.1 Non-DVB

Modulation	Code Rate	Min Data Rate	Max Data Rate	Option Card
BPSK	NONE	4800	10000000	
BPSK	VIT 1/2	2400	5000000	
BPSK	VIT 3/4	3600	7500000	
BPSK	VIT 7/8	4200	8750000	
BPSK	SEQ 1/2	2400	2048000	
BPSK	SEQ 3/4	3600	2048000	
BPSK	CSEQ 3/4	3600	2048000	
BPSK	SEQ 7/8	4200	2048000	
BPSK	TPC 21/44	2400	4772727	Supercard
BPSK	TPC .495	2376	4900000	Supercard
BPSK	TPC .793	3806	6300000	Supercard
BPSK	TPC 3/4	4100	6990000	Supercard
BPSK	TPC 7/8	4200	8200000	Supercard
BPSK	TPC 21/44	18000	477000	LDPC/TPC Card
BPSK	LDPC 1/2	18000	5000000	LDPC/TPC Card
QPSK	NONE	9600	20000000	
QPSK	VIT 1/2	4800	10000000	
QPSK	VIT 3/4	7200	15000000	
QPSK	VIT 7/8	8400	17500000	
QPSK	SEQ 1/2	4800	2048000	
QPSK	SEQ 3/4	7200	2048000	
QPSK	CSEQ 3/4	7200	2048000	

Modulation	Code Rate	Min Data Rate	Max Data Rate	Option Card
QPSK	SEQ 7/8	8400	2048000	
QPSK	TPC 1/2	4582	9545454	Supercard
QPSK	TPC 3/4	7200	15000000	Supercard
QPSK	TPC 7/8	8400	17500000	Supercard
QPSK	TPC .495	4752	6312000	Supercard
QPSK	TPC .793	7612	6312000	Supercard
QPSK	LDPC 1/2	18000	10000000	LDPC/TPC Card
QPSK	LDPC 2/3	24000	13333333	LDPC/TPC Card
QPSK	LDPC 3/4	27000	15000000	LDPC/TPC Card
QPSK	TPC 1/2	18000	9545400	LDPC/TPC Card
QPSK	TPC 3/4	27000	15000000	LDPC/TPC Card
QPSK	TPC 7/8	31500	17500000	LDPC/TPC Card
OQPSK	NONE	9600	20000000	
OQPSK	VIT 1/2	4800	10000000	
OQPSK	VIT 3/4	7200	15000000	
OQPSK	VIT 7/8	8400	17500000	
OQPSK	SEQ 1/2	4800	2048000	
OQPSK	SEQ 3/4	7200	2048000	
OQPSK	SEQ 7/8	8400	2048000	
OQPSK	TPC 1/2	4582	9545454	Supercard
OQPSK	TPC 3/4	7200	15000000	Supercard
OQPSK	TPC 7/8	8400	17500000	Supercard
OQPSK	TPC .495	4752	6312000	Supercard
OQPSK	TPC .793	7612	6312000	Supercard
OQPSK	LDPC 1/2	18000	10000000	LDPC/TPC Card
OQPSK	LDPC 2/3	24000	13333333	LDPC/TPC Card
OQPSK	LDPC 3/4	27000	15000000	LDPC/TPC Card
OQPSK	TPC 1/2	18000	9545400	LDPC/TPC Card
OQPSK	TPC 3/4	27000	15000000	LDPC/TPC Card
OQPSK	TPC 7/8	31500	17500000	LDPC/TPC Card
8PSK	TRE 2/3	9600	20000000	
8PSK	TPC 3/4	10800	20000000	Supercard
8PSK	TPC 7/8	12600	20000000	Supercard
8PSK	TPC .495	9504	6312000	Supercard
8PSK	TPC .793	15225	6312000	Supercard
8PSK/8QAM	LDPC 2/3	36000	20000000	LDPC/TPC Card

Modulation	Code Rate	Min Data Rate	Max Data Rate	Option Card
8PSK/8QAM	LDPC 3/4	40500	20000000	LDPC/TPC Card
8PSK	TPC 3/4	40000	20000000	LDPC/TPC Card
8PSK	TPC 7/8	48000	20000000	LDPC/TPC Card
16QAM	VIT 3/4	14400	20000000	
16QAM	VIT 7/8	16840	20000000	
16QAM	TPC 3/4	1440	20000000	Supercard
16QAM	TPC 7/8	16800	20000000	Supercard
16QAM	TPC .495	9504	6312000	Supercard
16QAM	TPC .793	15225	6312000	Supercard
16QAM	TPC 3/4	54000	20000000	LDPC/TPC Card
16QAM	TPC 7/8	63000	20000000	LDPC/TPC Card
16QAM	LDPC 3/4	54000	20000000	LDPC/TPC Card

7.19.2 DVB

187 Mode			
Modulation	Code Rate	Min Data Rate	Max Data Rate
BPSK	VIT 1/2	2400	4583333
BPSK	VIT 2/3	2934	6111111
BPSK	VIT 3/4	3300	6875000
BPSK	VIT 5/6	3667	7638888
BPSK	VIT 7/8	3850	8020833
QPSK	VIT 1/2	4400	9166666
QPSK	VIT 2/3	5867	12222222
QPSK	VIT 3/4	6600	13750000
QPSK	VIT 5/6	7334	15277777
QPSK	VIT 7/8	7700	16041666
8PSK	TRE 2/3	8800	18333333
8PSK	TRE 5/6	11000	20000000
8PSK	TRE 8/9	11734	20000000
16QAM	TRE 3/4	13200	20000000
16QAM	TRE 7/8	15400	20000000

188 Mode			
Modulation	Code Rate	Min Data Rate	Max Data Rate
BPSK	VIT 1/2	2400	4607843
BPSK	VIT 2/3	2950	6143790
BPSK	VIT 3/4	3318	6911764
BPSK	VIT 5/6	3687	7679738
BPSK	VIT 7/8	3871	8063725
QPSK	VIT 1/2	4424	9215686
QPSK	VIT 2/3	5899	12287581
QPSK	VIT 3/4	6636	13823529
QPSK	VIT 5/6	7373	15359477
QPSK	VIT 7/8	7742	16127450
8PSK	TRE 2/3	8848	18431372
8PSK	TRE 5/6	11059	20000000
8PSK	TRE 8/9	11797	20000000
16QAM	TRE 3/4	13271	20000000
16QAM	TRE 7/8	15483	20000000

204 Mode			
Modulation	Code Rate	Min Data Rate	Max Data Rate
BPSK	VIT 1/2	2400	5000000
BPSK	VIT 2/3	3200	6666666
BPSK	VIT 3/4	3600	7500000
BPSK	VIT 5/6	4000	8333333
BPSK	VIT 7/8	4200	8750000
QPSK	VIT 1/2	4800	10000000
QPSK	VIT 2/3	6400	13333333
QPSK	VIT 3/4	7200	15000000
QPSK	VIT 5/6	8000	16666666
QPSK	VIT 7/8	8400	17500000
8PSK	TRE 2/3	9600	20000000
8PSK	TRE 5/6	12000	20000000
8PSK	TRE 8/9	12800	20000000
16QAM	TRE 3/4	14400	20000000
16QAM	TRE 7/8	16800	20000000

7.20 BER Specifications

7.20.1 BER Performance (Viterbi)

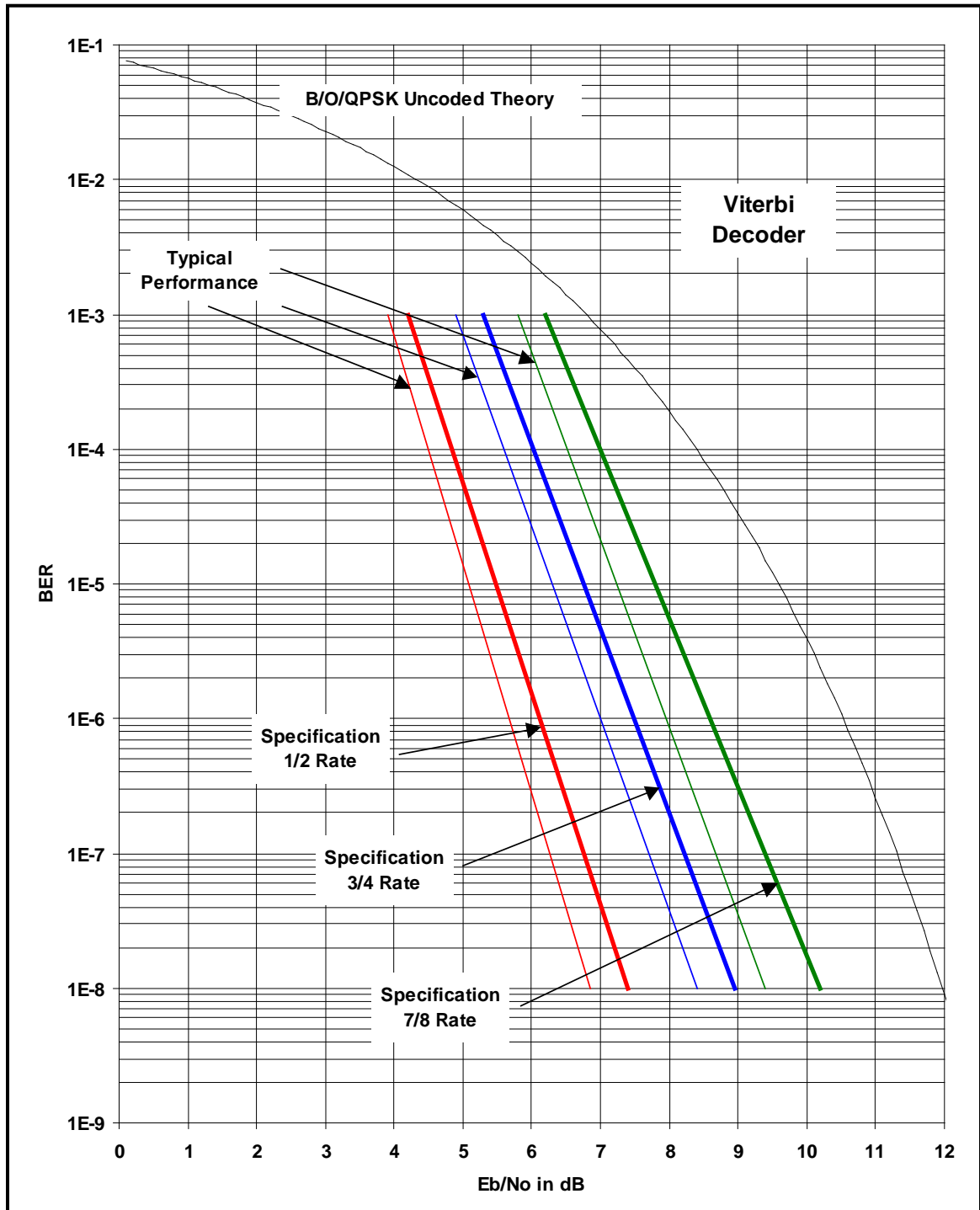

Figure 7-1 B/O/QPSK BER Performance (Viterbi)

Note: E_b/N_0 values include the effect of using Differential Decoding and V.35 descrambling.

7.20.2 BER Performance (Sequential)

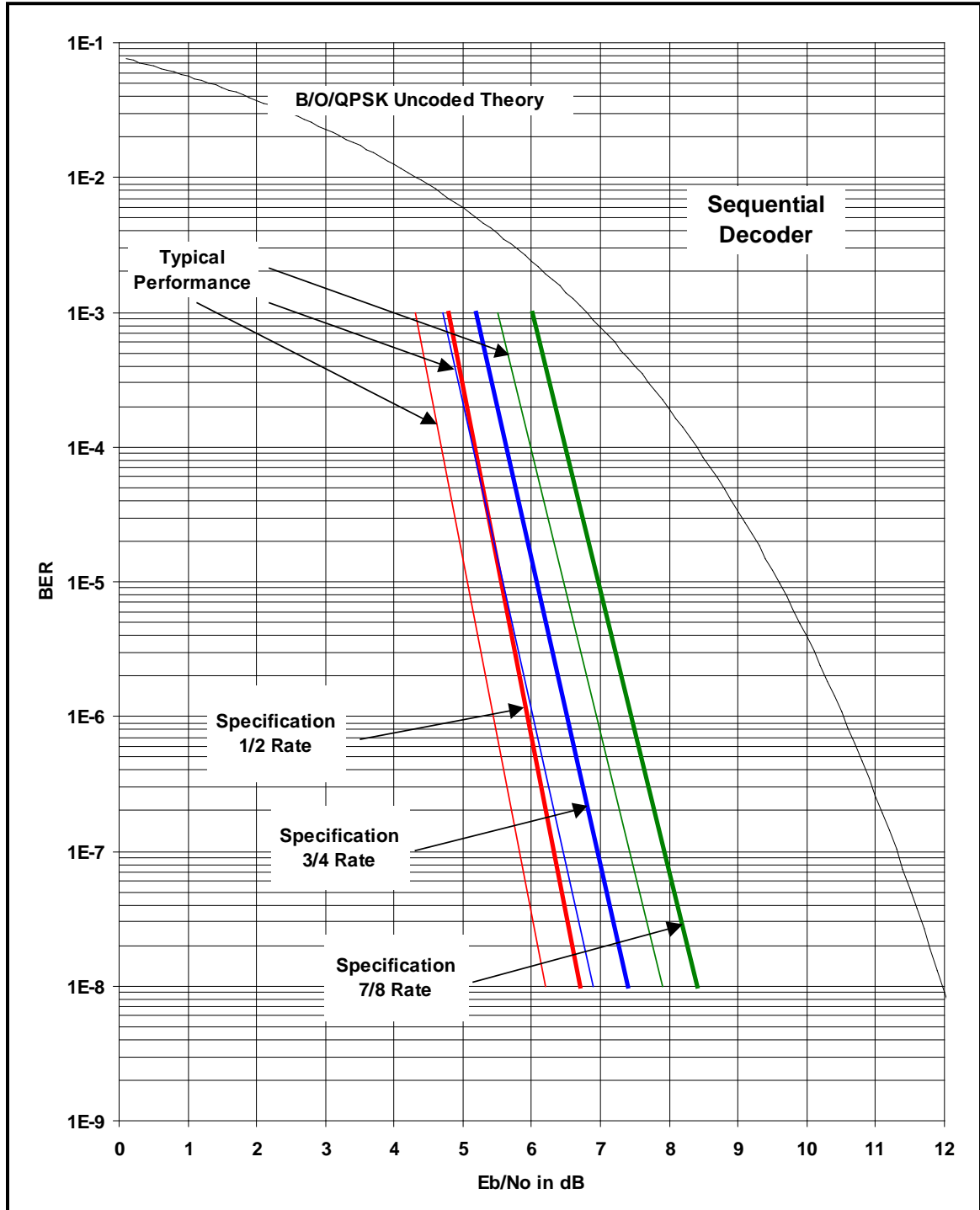

Figure 7-2 B/O/QPSK BER Performance (Sequential)

Note: E_b/N_0 values include the effect of using Differential Decoding and V.35 descrambling.

7.20.3 BER Performance (Viterbi with Reed-Solomon)

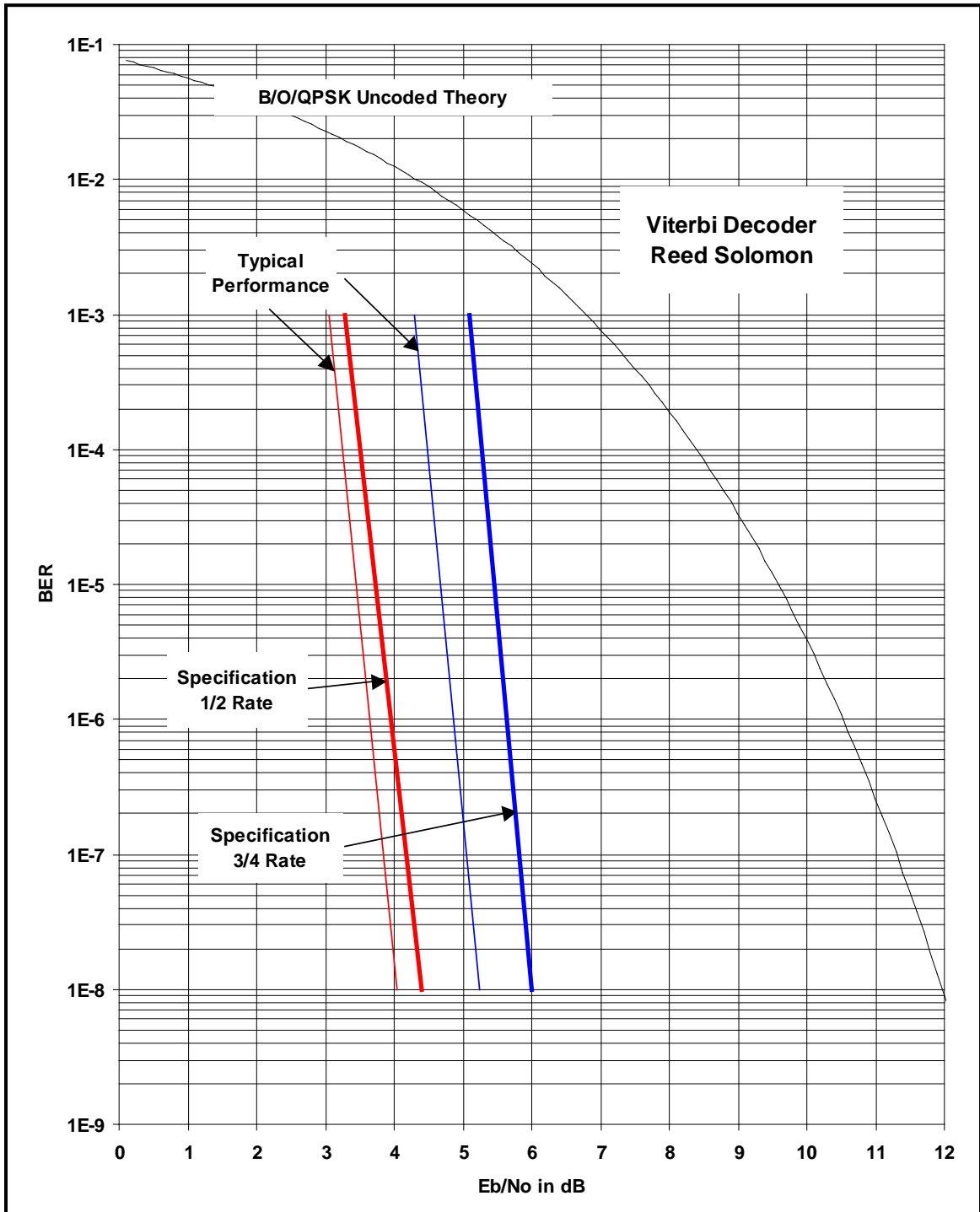

Figure 7-3 B/O/QPSK BER Performance (Viterbi w/R-S)

Note: E_b/N_0 values include the effect of using Differential Decoding.

7.20.4 BER Performance ((O)QPSK Turbo)

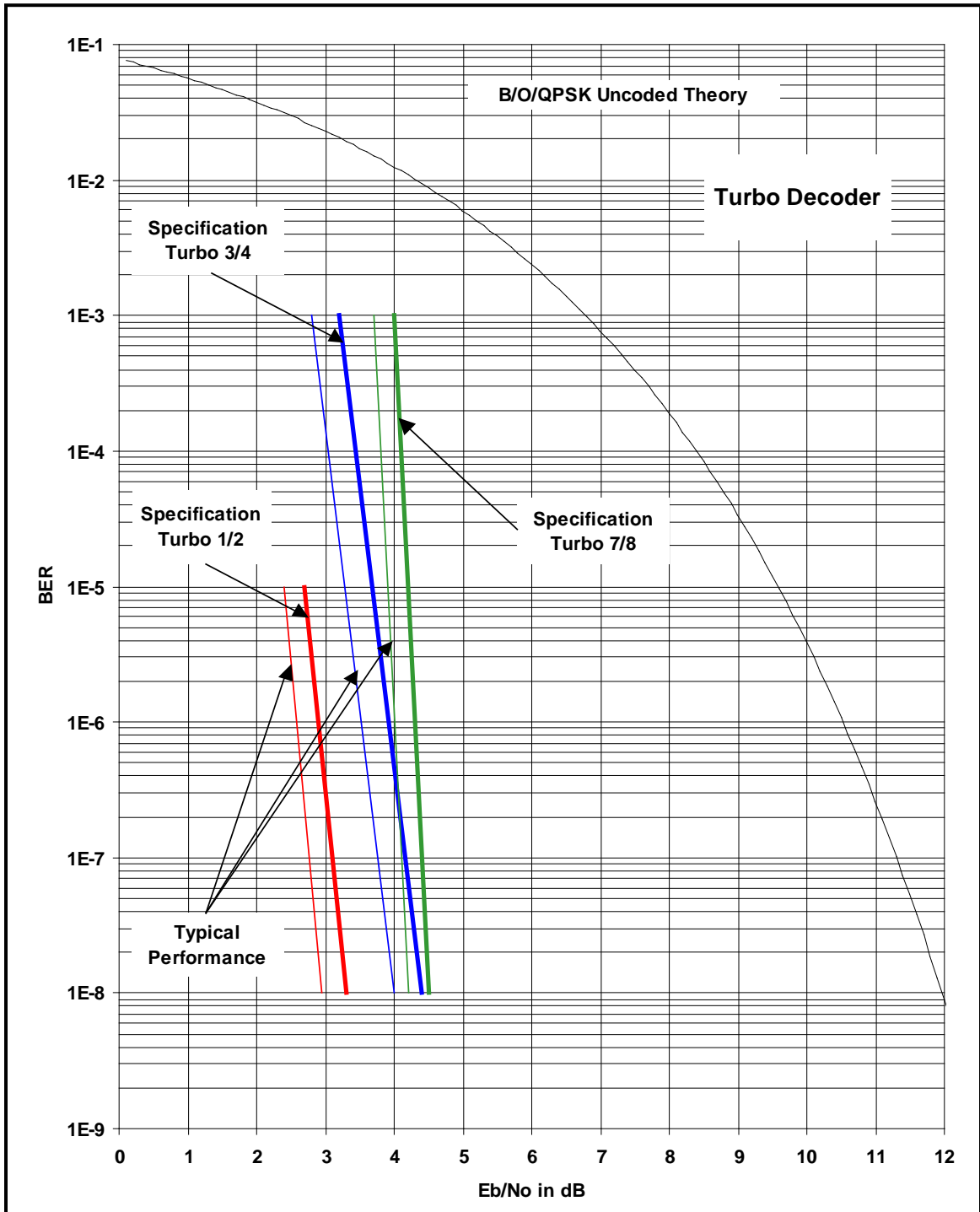

Figure 7-4 BPSK (O)QPSK BER Performance (Turbo)

7.20.5 BER Performance (B/O/QPSK Turbo)

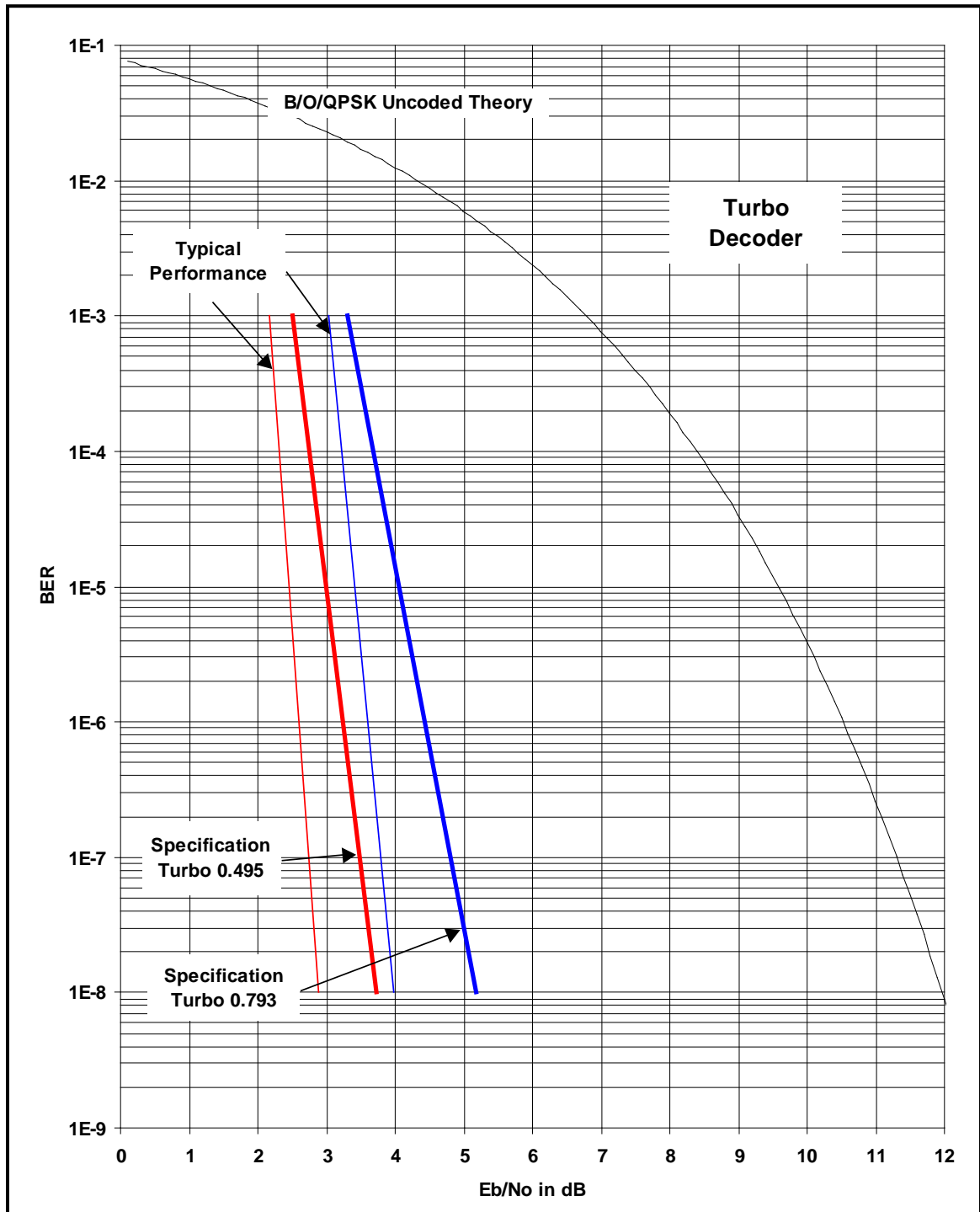

Figure 7-5 B/O/QPSK BER Performance (Turbo)

Note: E_b/N_0 values include the effect of using interleaving and maximum iterations.

7.20.6 BER Performance (8PSK Turbo)

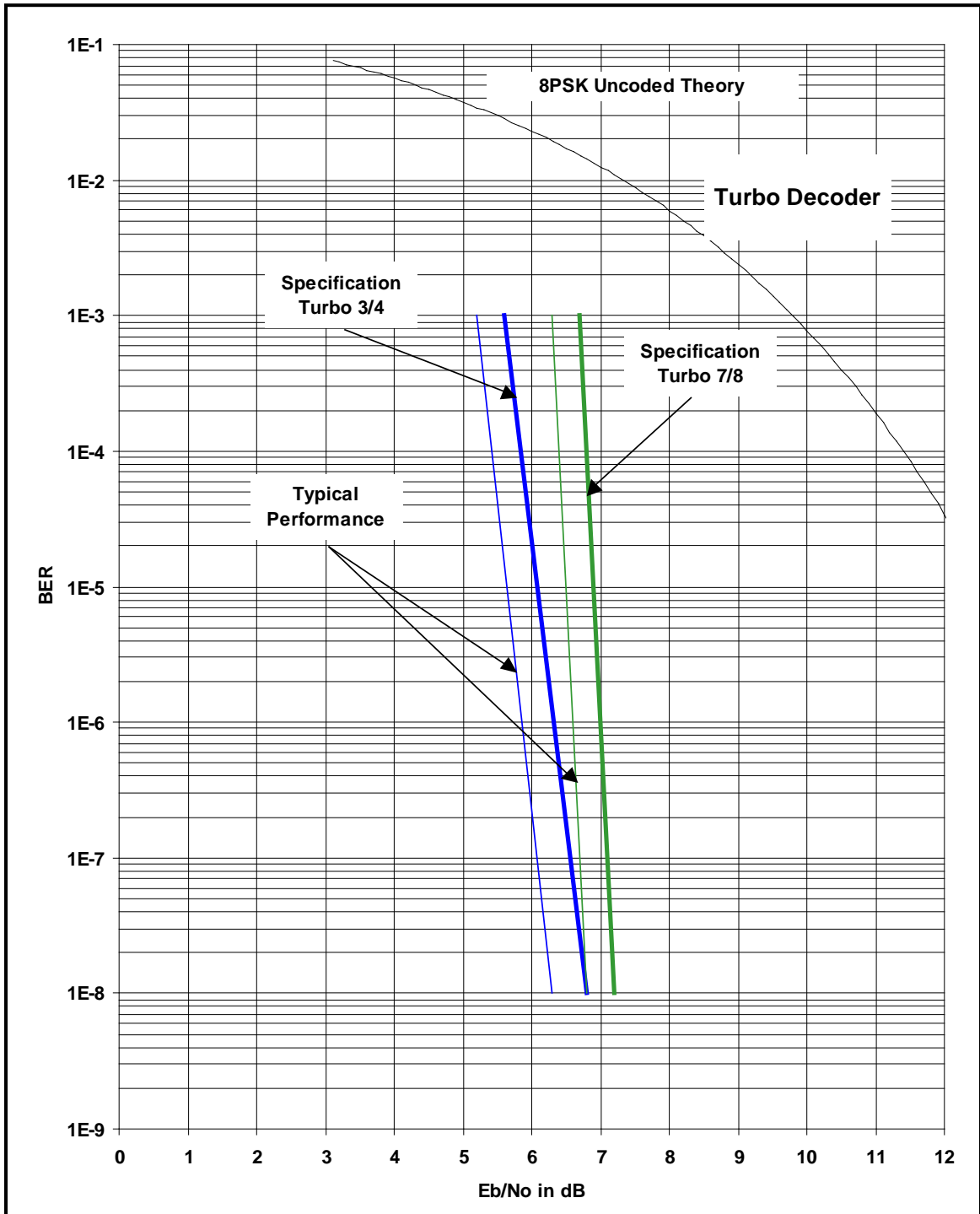

Figure 7-6 BPSK 8PSK BER Performance (Turbo)

7.20.7 BER Performance (8PSK Trellis)

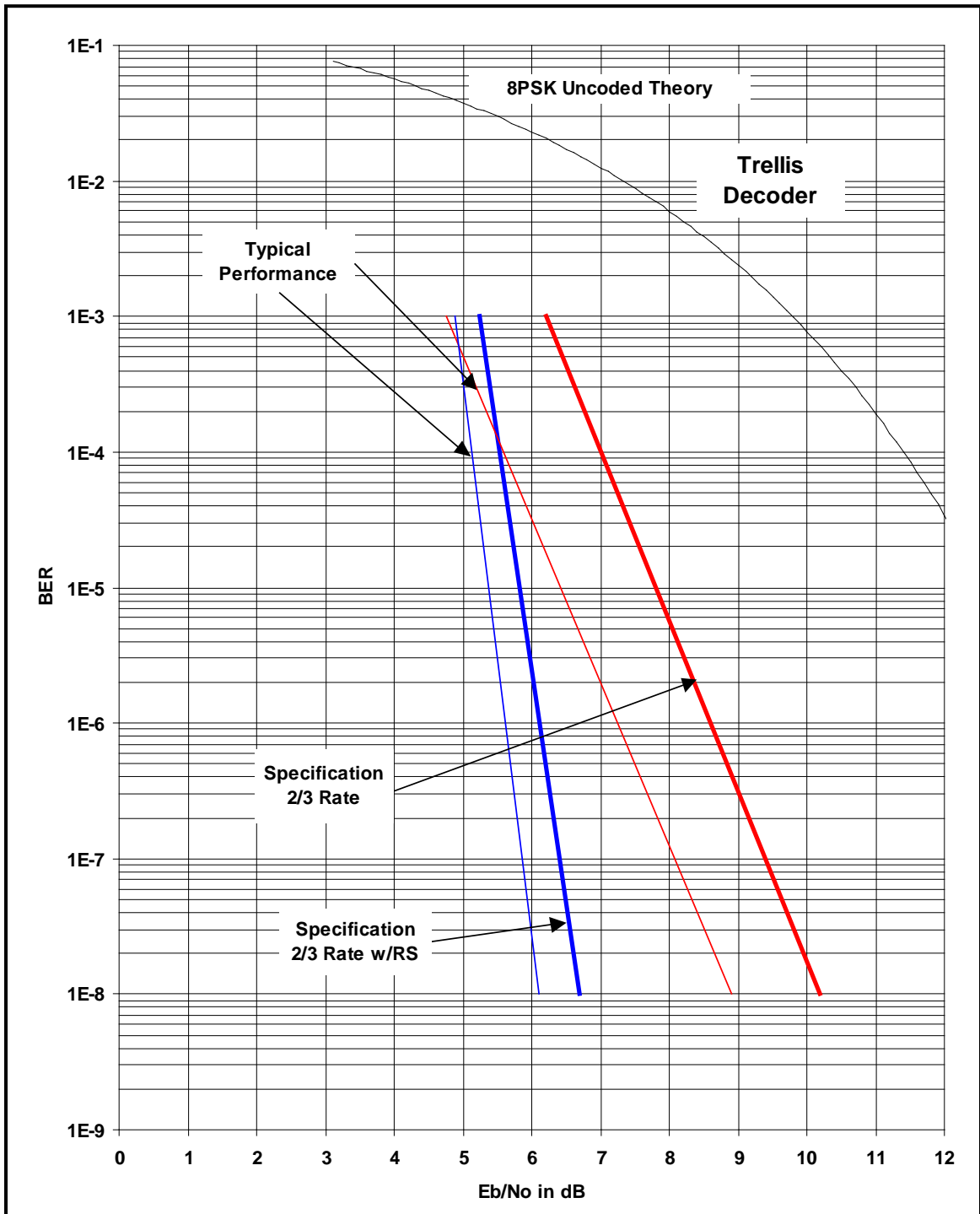

Figure 7-7 8PSK BER Performance (Trellis)

Note: E_b/N_0 values include the effect of using Differential Decoding and V.35 Descrambling.

7.20.8 BER Performance (8PSK Turbo)

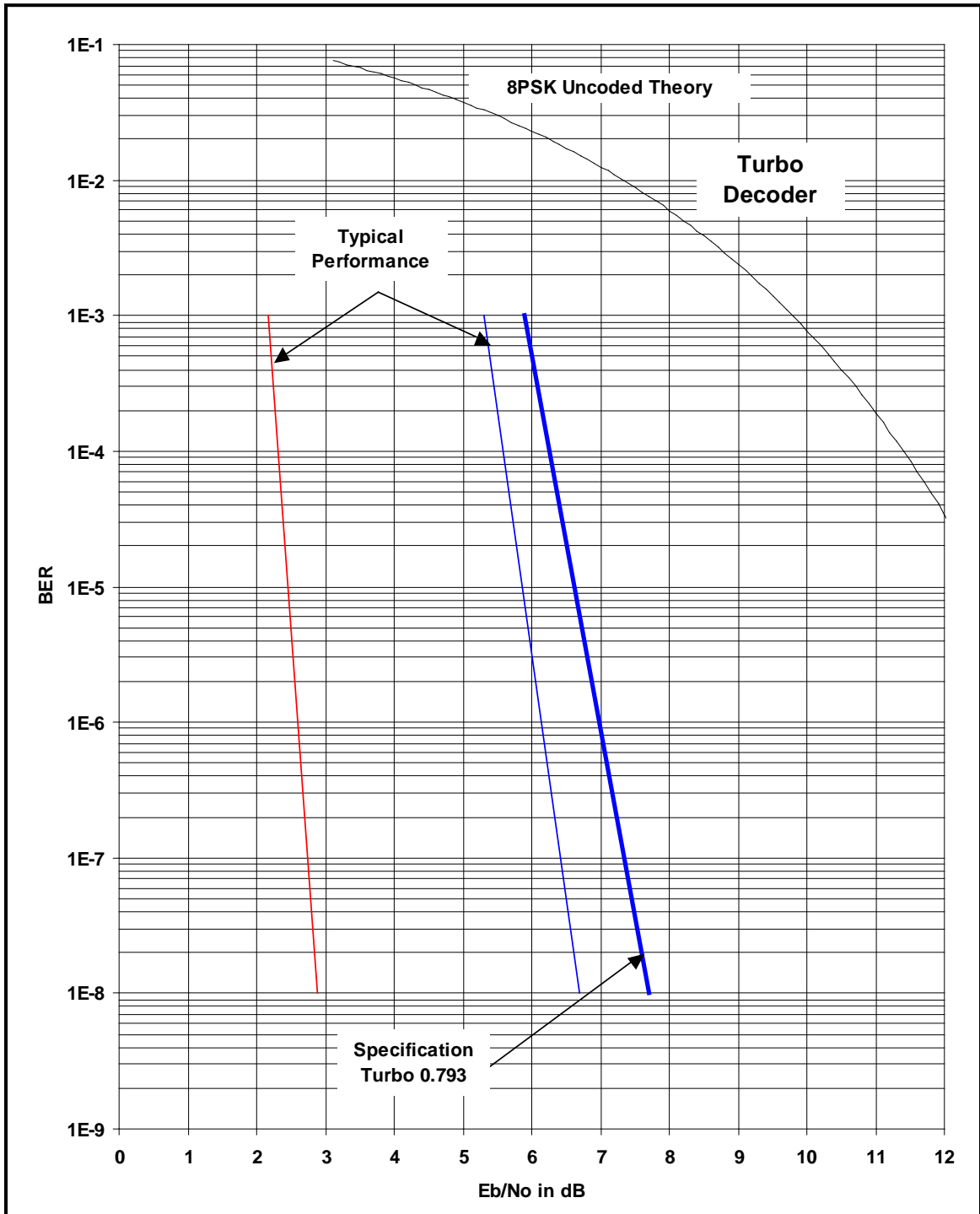

Figure 7-8 8PSK BER Performance (Turbo)

Note: *Eb/No* values include the effect of using interleaving and maximum iterations.

7.20.9 BER Performance (16QAM Viterbi)

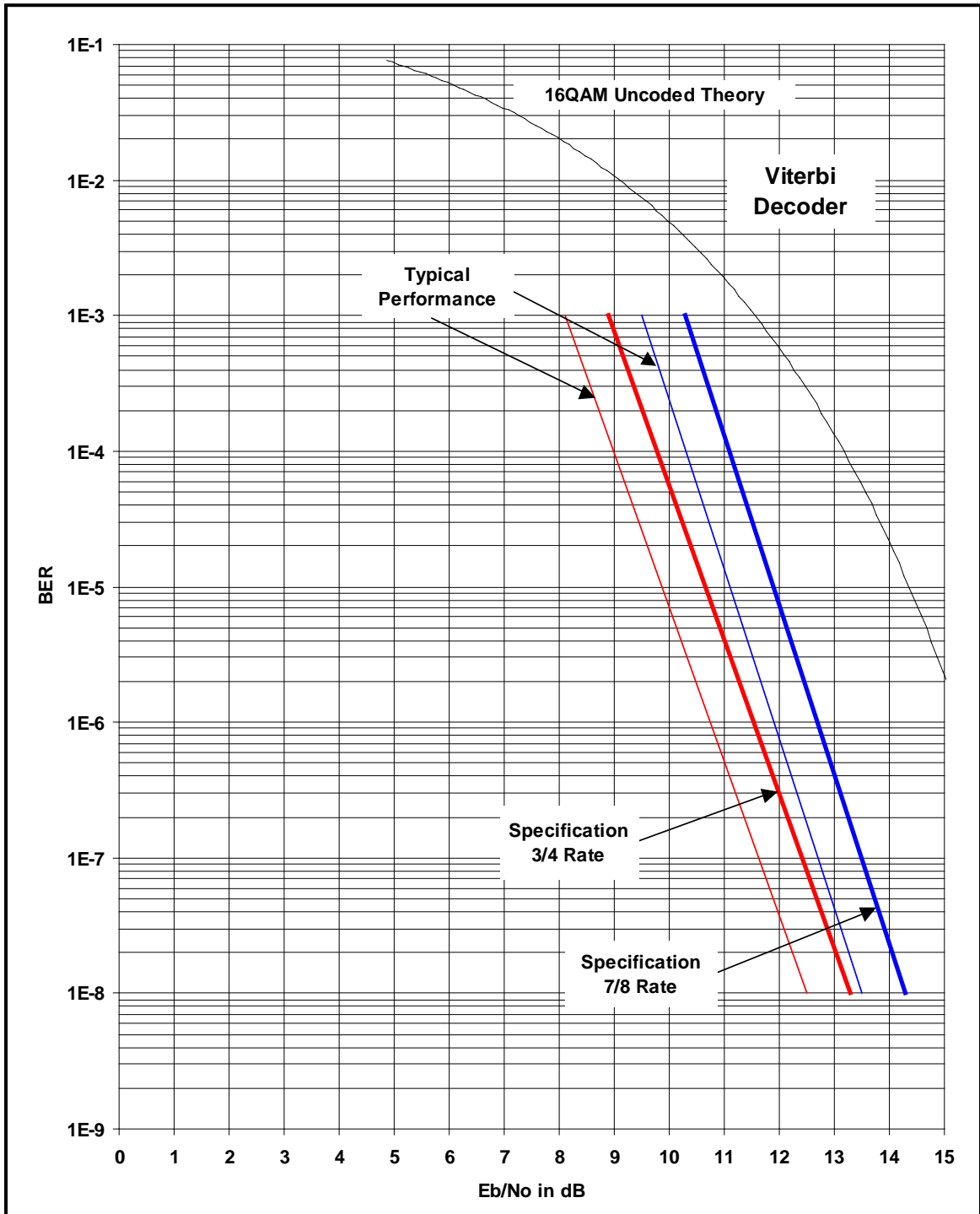

Figure 7-9 16QAM BER Performance (Viterbi)

Note: E_b/N_0 values include the effect of using Differential Decoding and V.35 Descrambling.

7.20.10 BER Performance (16QAM Viterbi with Reed-Solomon)

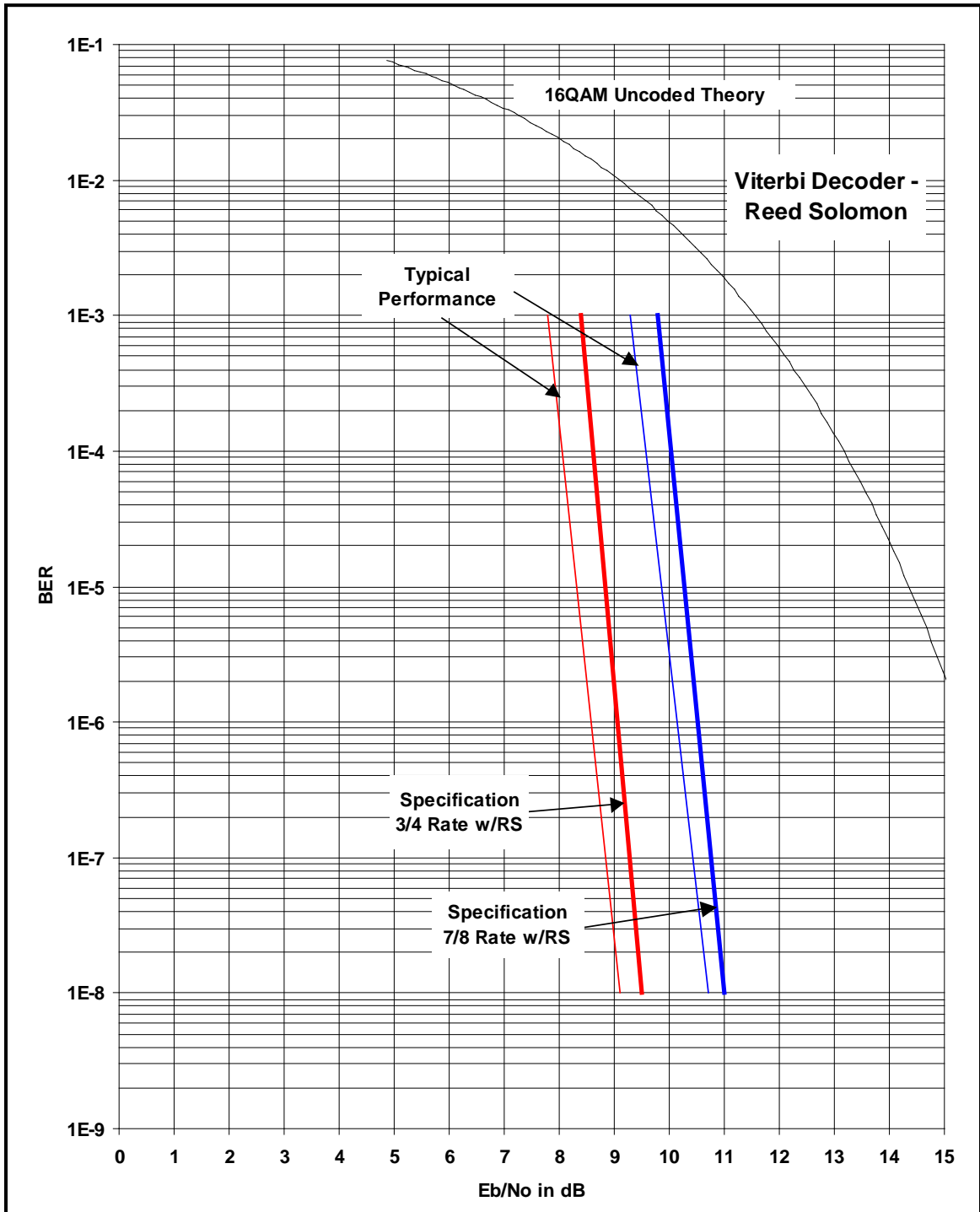

Figure 7-10 BPSK 16QAM BER Performance (Viterbi w/R-S)

Note: *E_b/N_o values include the effect of using Differential Decoding.*

7.20.11 BER Performance (16QAM Turbo)

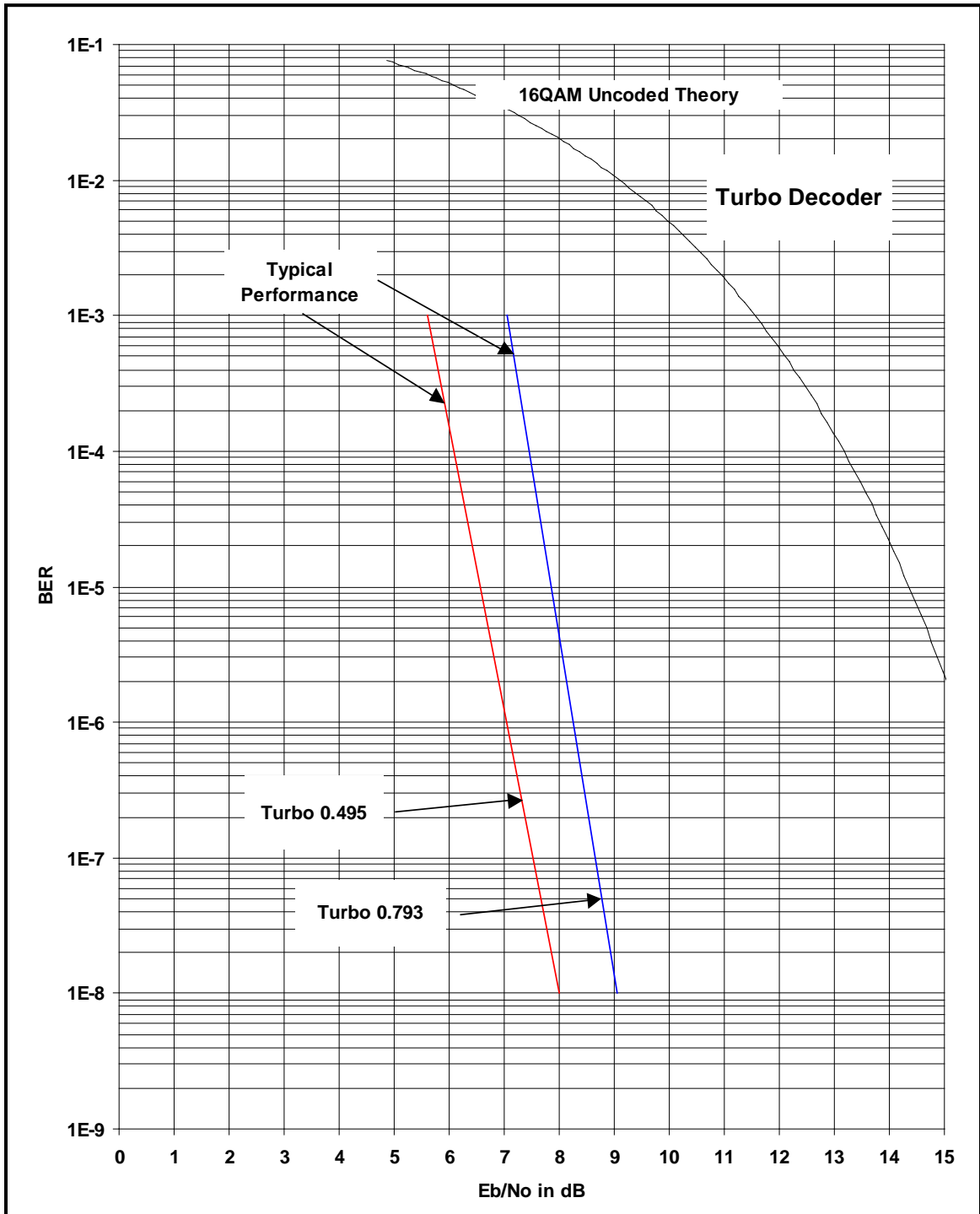

Figure 7-11 BPSK 16QAM BER Performance (Turbo)

Note: *E_b/N_o* values include the effect of using interleaving and maximum iterations.

7.20.12 BER Performance (16QAM Turbo)

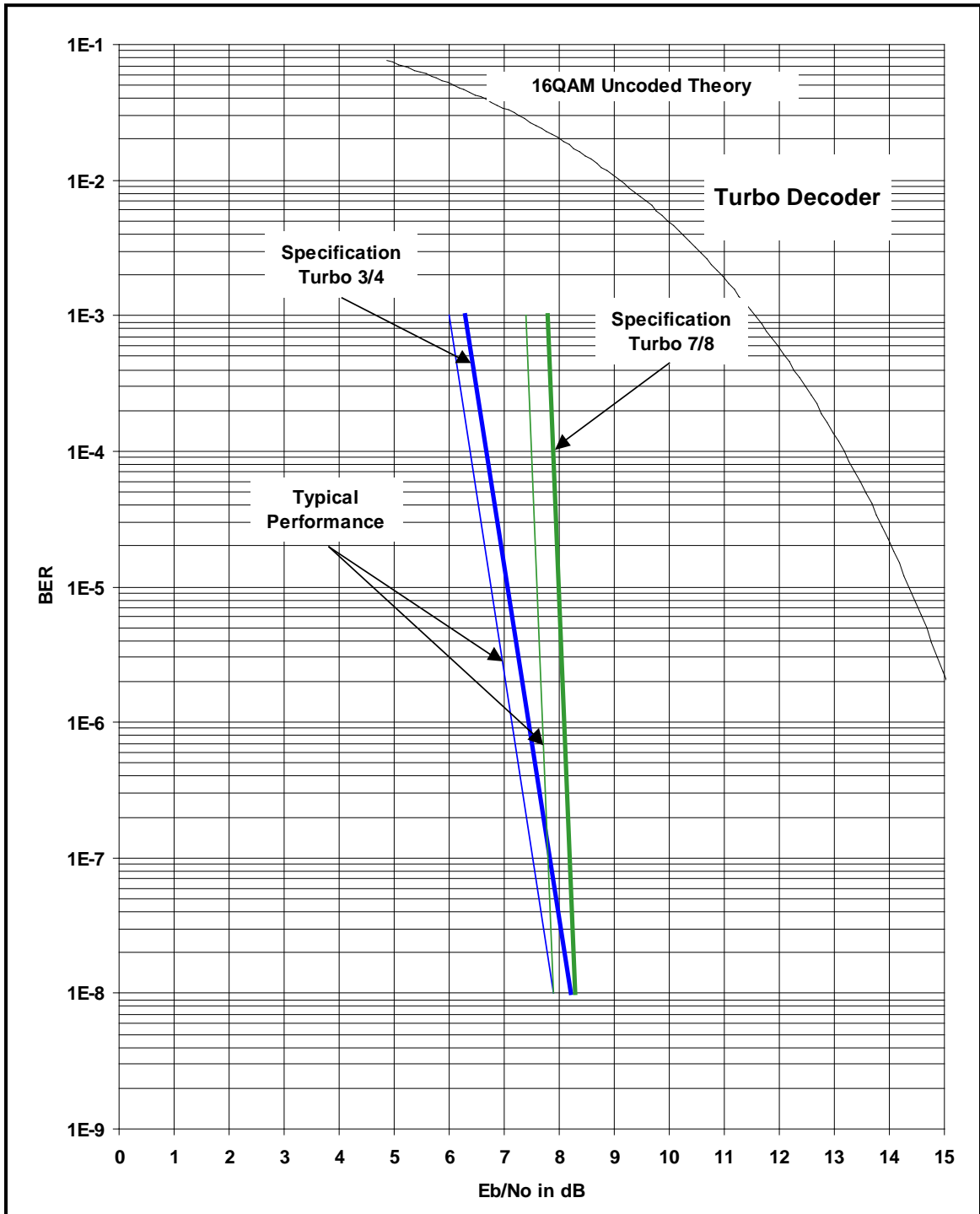

Figure 7-12 BPSK 16QAM BER Performance (Turbo)

7.20.13 1/2 Rate B/O/QPSK BER Performance (LDPC)

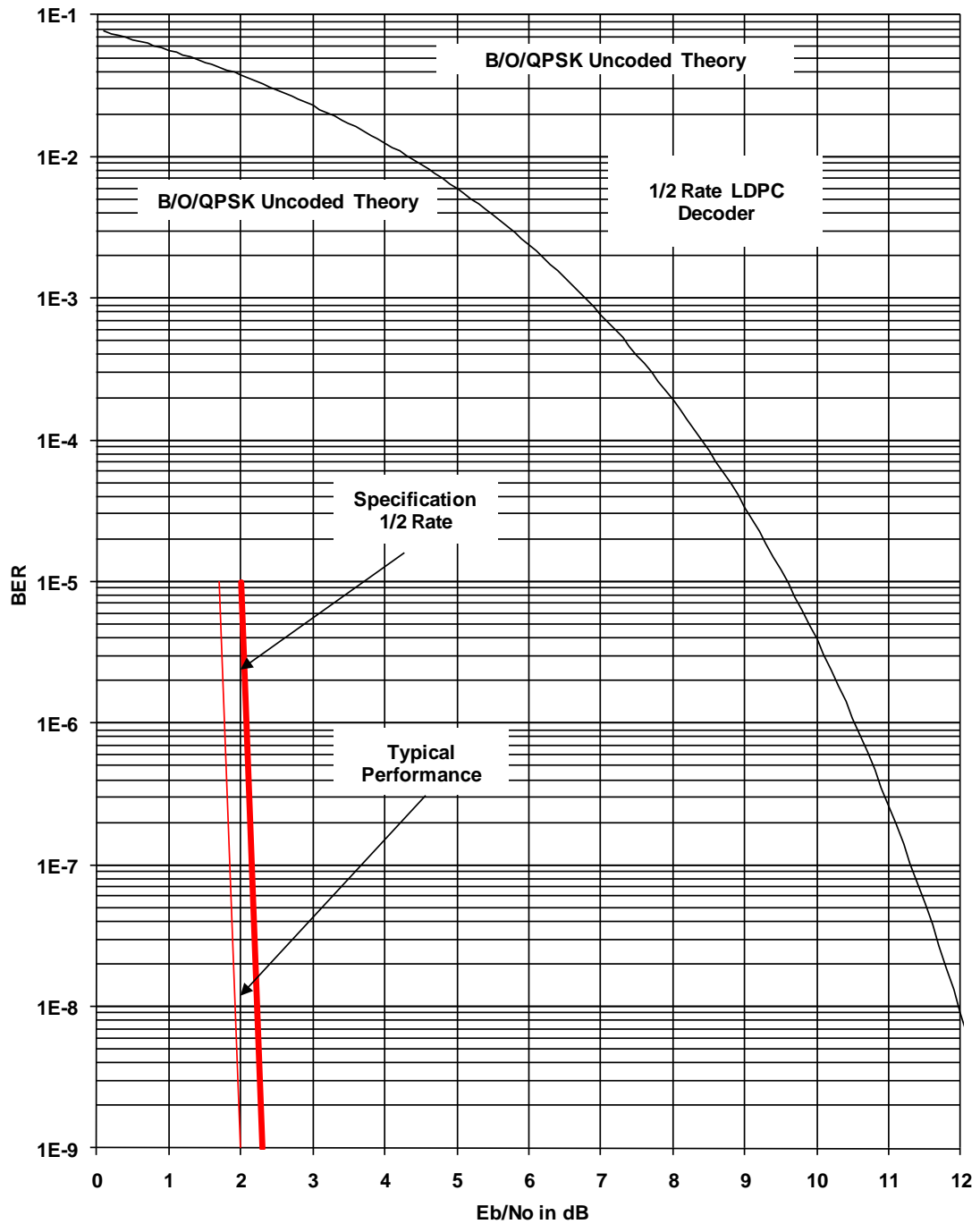

Figure 7-13 – Rate 1/2 B/O/QPSK BER Performance (LDPC)

7.20.14 2/3 Rate Q/8PSK/8QAM BER Performance (LDPC)

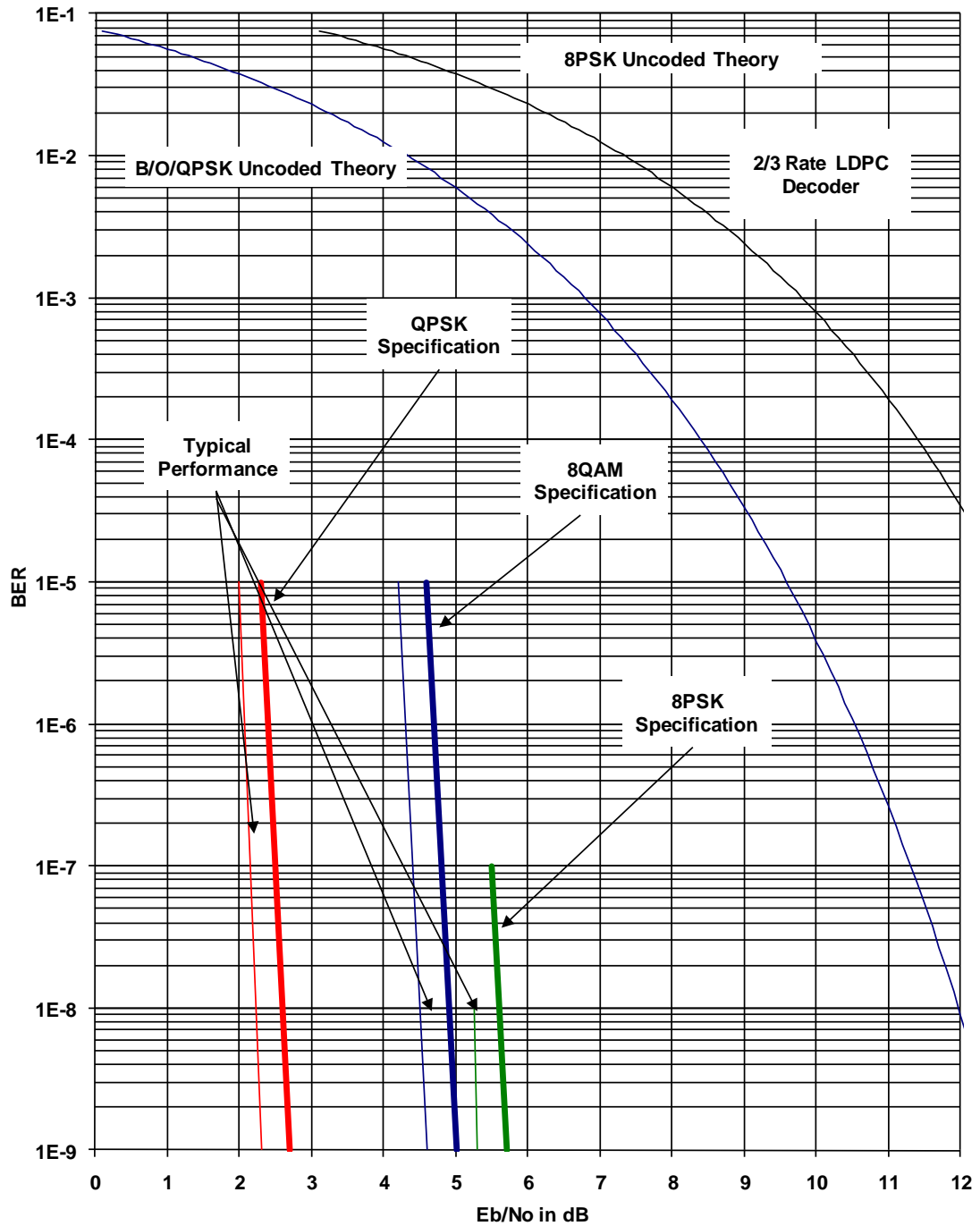

Figure 7-14 – Rate 2/3 Q/8PSK/8QAM BER Performance (LDPC)

7.20.15 3/4 Rate Q/8PSK, 8/16QAM BER Performance (LDPC)

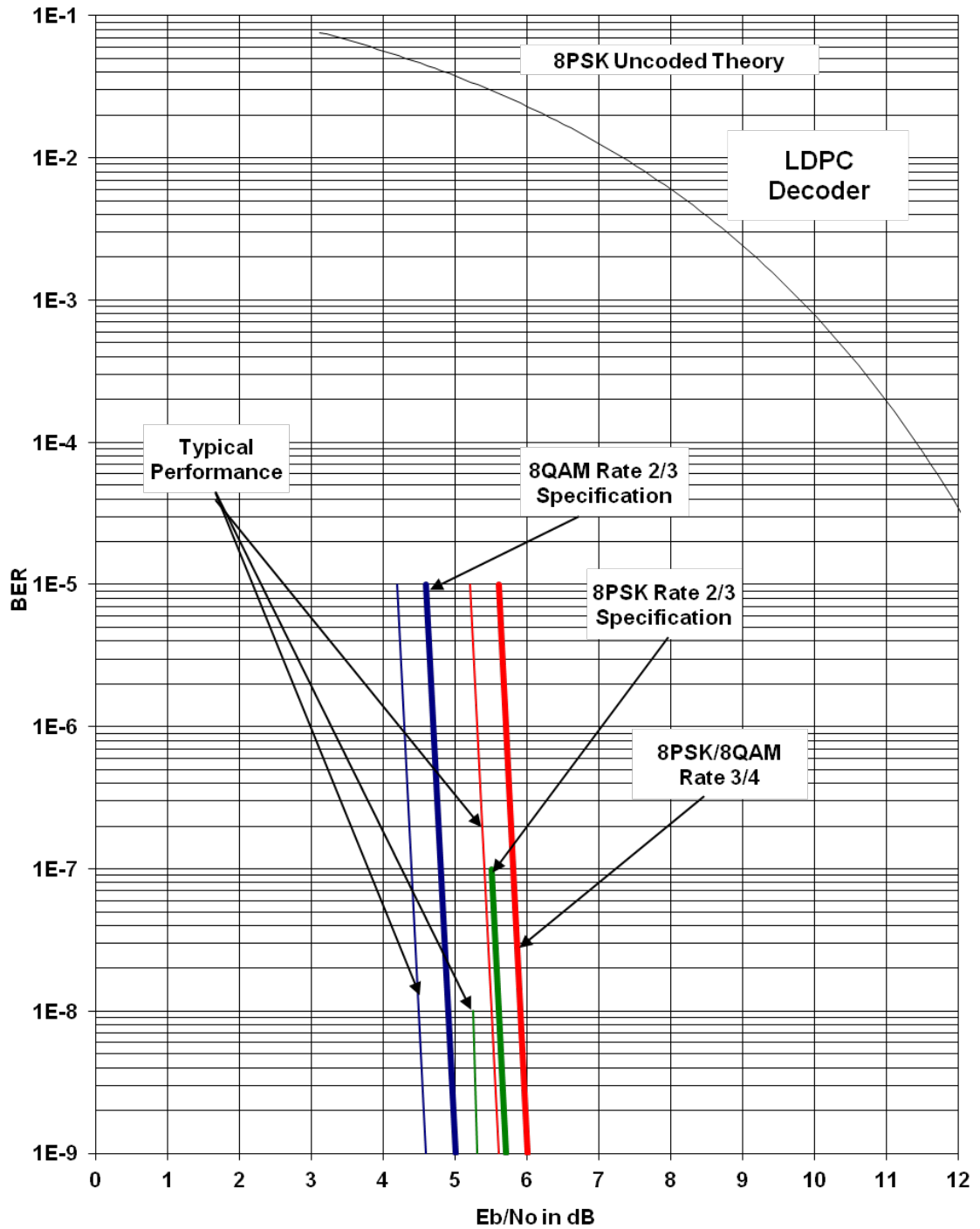

Figure 7-15 – Rate 3/4 Q/8PSK/8QAM BER Performance (LDPC)

BER	Specification			Typical		
	1/2 Rate	3/4 Rate	7/8 Rate	1/2 Rate	3/4 Rate	7/8 Rate
1E-3	4.2 dB	5.3 dB	6.2 dB	3.9 dB	4.9 dB	5.8 dB
1E-4	4.8 dB	6.1 dB	7.1 dB	4.5 dB	5.6 dB	6.5 dB
1E-5	5.5 dB	6.8 dB	7.9 dB	5.1 dB	6.3 dB	7.2 dB
1E-6	6.1 dB	7.6 dB	8.6 dB	5.7 dB	7 dB	7.9 dB
1E-7	6.7 dB	8.3 dB	9.3 dB	6.2 dB	7.7 dB	8.6 dB
1E-8	7.4 dB	8.9 dB	10.2 dB	6.8 dB	8.4 dB	9.4 dB
1E-9	8.2 dB	9.7 dB	11 dB	7.4 dB	9.1 dB	10 dB
1E-10	9 dB	10.3 dB	11.7 dB	8.1 dB	9.8 dB	10.5 dB

BER	Specification			Typical		
	1/2 Rate	3/4 Rate	7/8 Rate	1/2 Rate	3/4 Rate	7/8 Rate
1E-3	4.8 dB	5.2 dB	6 dB	4.3 dB	4.7 dB	5.5 dB
1E-4	5.2 dB	5.7 dB	6.4 dB	4.7 dB	5.2 dB	5.9 dB
1E-5	5.6 dB	6.1 dB	6.9 dB	5.1 dB	5.6 dB	6.4 dB
1E-6	5.9 dB	6.5 dB	7.4 dB	5.4 dB	6.1 dB	6.9 dB
1E-7	6.3 dB	7 dB	7.9 dB	5.8 dB	6.5 dB	7.4 dB
1E-8	6.7 dB	7.4 dB	8.4 dB	6.2 dB	6.9 dB	7.9 dB
1E-9	7.1 dB	7.8 dB	8.9 dB	6.6 dB	7.4 dB	8.4 dB
1E-10	7.4 dB	8.3 dB	9.4 dB	6.9 dB	7.8 dB	8.9 dB

BER	Specification			Typical		
	1/2 Rate	3/4 Rate	7/8 Rate	1/2 Rate	3/4 Rate	7/8 Rate
1E-3	3.3 dB	5.1 dB	-	3 dB	4.3 dB	5.3 dB
1E-4	3.5 dB	5.3 dB	-	3.2 dB	4.5 dB	5.7 dB
1E-5	3.8 dB	5.4 dB	6.5 dB	3.4 dB	4.7 dB	6 dB
1E-6	4.1 dB	5.6 dB	6.7 dB	3.6 dB	4.9 dB	6.4 dB
1E-7	4.2 dB	5.8 dB	6.9 dB	3.8 dB	5.1 dB	6.7 dB
1E-8	4.4 dB	6 dB	7.2 dB	4 dB	5.3 dB	7.1 dB
1E-9	4.7 dB	6.1 dB	7.5 dB	4.2 dB	5.4 dB	7.4 dB
1E-10	5 dB	6.3 dB	7.8 dB	4.4 dB	5.6 dB	7.7 dB

BER	Specification		Typical	
	Turbo 0.495	Turbo 0.793	Turbo 0.495	Turbo 0.793
	1E-3	2.5 dB	3.3 dB	2.2 dB
1E-4	2.7 dB	3.7 dB	2.3 dB	3.2 dB
1E-5	3 dB	4.1 dB	2.5 dB	3.4 dB
1E-6	3.2 dB	4.4 dB	2.6 dB	3.6 dB
1E-7	3.5 dB	4.8 dB	2.7 dB	3.8 dB
1E-8	3.7 dB	5.2 dB	2.9 dB	4 dB
1E-9	4 dB	5.6 dB	3 dB	4.2 dB
1E-10	4.2 dB	5.9 dB	3.2 dB	4.4 dB

BER	Specification		Typical	
	2/3 Rate	2/3 Rate w/RS	2/3 Rate	2/3 Rate w/RS
	1E-3	6.2 dB	5.2 dB	4.8 dB
1E-4	7 dB	5.5 dB	5.6 dB	5.1 dB
1E-5	7.8 dB	5.8 dB	6.4 dB	5.4 dB
1E-6	8.7 dB	6.2 dB	7.2 dB	5.6 dB
1E-7	9.5 dB	6.5 dB	8.1 dB	5.8 dB
1E-8	10.2 dB	6.7 dB	8.9 dB	6.1 dB
1E-9	11.1 dB	6.9 dB	9.7 dB	6.3 dB
1E-10	11.9 dB	7.3 dB	10.5 dB	6.6 dB

BER	Specification		Typical	
	Turbo 0.495	Turbo 0.793	Turbo 0.495	Turbo 0.793
	1E-3	TBD	5.9 dB	2.2 dB
1E-4	TBD	6.3 dB	2.3 dB	5.6 dB
1E-5	TBD	6.6 dB	2.5 dB	5.8 dB
1E-6	TBD	6.9 dB	2.6 dB	6.1 dB
1E-7	TBD	7.3 dB	2.7 dB	6.4 dB
1E-8	TBD	7.7 dB	2.9 dB	6.7 dB
1E-9	TBD	8 dB	3 dB	6.9 dB
1E-10	TBD	8.4 dB	3.2 dB	7.1 dB

BER	Specification		Typical	
	3/4 Rate	7/8 Rate	3/4 Rate	7/8 Rate
1E-3	8.9 dB	10.3 dB	8.1 dB	9.5 dB
1E-4	9.8 dB	11.1 dB	9 dB	10.3 dB
1E-5	10.7 dB	11.9 dB	9.9 dB	11.1 dB
1E-6	11.5 dB	12.7 dB	10.7 dB	11.9 dB
1E-7	12.4 dB	13.5 dB	11.6 dB	12.7 dB
1E-8	13.3 dB	14.3 dB	12.5 dB	13.5 dB
1E-9	14.2 dB	15.1 dB	13.4 dB	14.3 dB
1E-10	15 dB	15.9 dB	14.2 dB	15.1 dB

BER	Specification'		Typical'	
	3/4-Rate'	7/8-Rate'	3/4-Rate'	7/8-Rate'
1E-3	8.4 dB'	9.8 dB'	7.8 dB'	9.3 dB'
1E-4	8.6 dB'	10.1 dB'	8.1 dB'	9.6 dB'
1E-5	8.9 dB'	10.3 dB'	8.3 dB'	9.9 dB'
1E-6	9.1 dB'	10.5 dB'	8.6 dB'	10.2 dB'
1E-7	9.3 dB'	10.8 dB'	8.8 dB'	10.4 dB'
1E-8	9.5 dB'	11.1 dB'	9.1 dB'	10.7 dB'
1E-9	9.8 dB'	11.3 dB'	9.3 dB'	11 dB'
1E-10	10 dB'	11.5 dB'	9.6 dB'	11.3 dB'

BER	Specification		Typical	
	Turbo 0.495	Turbo 0.793	Turbo 0.495	Turbo 0.793
1E-3	TBD	TBD	5.6 dB	7 dB
1E-4	TBD	TBD	6.1 dB	7.4 dB
1E-5	TBD	TBD	6.6 dB	7.8 dB
1E-6	TBD	TBD	7 dB	8.2 dB
1E-7	TBD	TBD	7.5 dB	8.6 dB
1E-8	TBD	TBD	8 dB	9 dB
1E-9	TBD	TBD	8.5 dB	9.4 dB
1E-10	TBD	TBD	9 dB	9.9 dB

BER	Specification			Typical		
	Turbo 1/2	Turbo 3/4	Turbo 7/8	Turbo 1/2	Turbo 3/4	Turbo 7/8
1E-3	TBD	3.2 dB	4 dB	TBD	2.8 dB	3.7 dB
1E-4	TBD	3.4 dB	4.1 dB	TBD	3 dB	3.8 dB
1E-5	2.7 dB	3.6 dB	4.2 dB	2.4 dB	3.2 dB	3.9 dB
1E-6	2.9 dB	3.8 dB	4.3 dB	2.6 dB	3.4 dB	4 dB
1E-7	3.1 dB	4.1 dB	4.4 dB	2.8 dB	3.7 dB	4.1 dB
1E-8	3.3 dB	4.4 dB	4.5 dB	3 dB	4 dB	4.2 dB

BER	Specification		Typical	
	Turbo 3/4	Turbo 7/8	Turbo 3/4	Turbo 7/8
1E-3	5.6 dB	6.7 dB	5.2 dB	6.3 dB
1E-4	5.8 dB	6.8 dB	5.4 dB	6.4 dB
1E-5	6 dB	6.9 dB	5.6 dB	6.5 dB
1E-6	6.2 dB	7 dB	5.8 dB	6.6 dB
1E-7	6.4 dB	7.1 dB	6 dB	6.7 dB
1E-8	6.8 dB	7.2 dB	6.3 dB	6.8 dB

BER	Specification		Typical	
	Turbo 3/4	Turbo 7/8	Turbo 3/4	Turbo 7/8
1E-3	6.3 dB	7.8 dB	6 dB	7.4 dB
1E-4	6.7 dB	7.9 dB	6.4 dB	7.5 dB
1E-5	7 dB	8 dB	6.7 dB	7.6 dB
1E-6	7.4 dB	8.1 dB	7.1 dB	7.7 dB
1E-7	7.8 dB	8.2 dB	7.5 dB	7.8 dB
1E-8	8.2 dB	8.3 dB	7.9 dB	7.9 dB

BER	Specification			Typical		
	1/2 Rate	2/3 Rate	3/4 Rate	1/2 Rate	2/3 Rate	3/4 Rate
1E-5	2 dB	2.3 dB	3 dB	1.7 dB	2 dB	2.6 dB
1E-9	2.3 dB	2.7 dB	3.3 dB	2 dB	2.3 dB	3 dB

Table 7-14 - 8PSK / 8-QAM Rate BER Performance (LDPC)								
BER	8PSK				8-QAM			
	Specification		Typical		Specification		Typical	
	2/3 Rate	3/4 Rate	2/3 Rate	3/4 Rate	2/3 Rate	3/4 Rate	2/3 Rate	3/4 Rate
1E-5	-	5.6 dB	-	5.2 dB	4.6 dB	5.6 dB	4.2 dB	5.2 dB
1E-9	5.7 dB	6 dB	5.3 dB	5.6 dB	5 dB	6 dB	4.6 dB	5.6 dB

Table 7-15 - 16QAM BER Performance (LDPC)		
BER	Specification	Typical
	3/4 Rate	3/4 Rate
1E-5	6.8 dB	6.2 dB
1E-9	7.1 dB	6.8 dB

Table 7-16. Open Network Performance							
BER	Specification			Typical			
	IBS	IDR	IDR	IBS	IBS	IDR	IDR
	1/2 Rate	3/4 Rate	7/8 Rate	1/2 Rate	3/4 Rate	3/4 Rate	7/8 Rate
1E-3	4.1 dB	5.2 dB	6.2 dB	3.25 dB	4.2 dB	4.35 dB	5.8 dB
1E-4	4.6 dB	6.0 dB	7.1 dB	3.8 dB	4.9 dB	5.25 dB	6.5 dB
1E-4	5.3 dB	6.7 dB	7.9 dB	4.6 dB	5.6 dB	5.9 dB	7.2 dB
1E-6	6.0 dB	7.5 dB	8.6 dB	5.2 dB	6.3 dB	6.6 dB	7.9 dB
1E-7	6.6 dB	8.2 dB	9.3 dB	5.9 dB	6.9 dB	7.3 dB	8.6 dB
1E-8	7.1 dB	8.7 dB	10.2 dB	6.4 dB	7.5 dB	7.8 dB	9.4 dB

7.20.16 AGC Output Voltage

The AGC Output Voltage is a function of the Input Power Level in dBm. The AGC Output Voltage is found on the Alarm connector Pin 14 of J15.

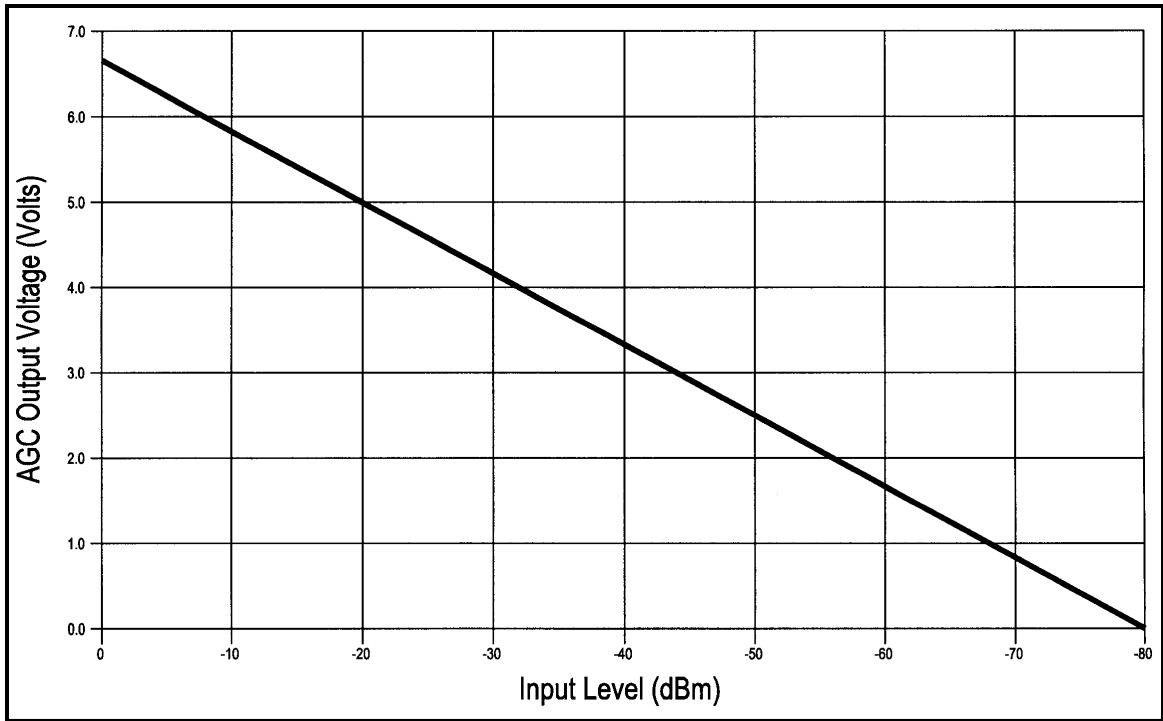

Figure 7-16 AGC Voltage Monitor

BLANK PAGE

Appendix A. Product Options

A.1 Hardware Options

The following enhanced interface cards are available.

A.2 G.703/IDR ESC Interface

The modem can be equipped with G.703 T1/E1/T2/E2 /IDR ESC Interface

A.3 Internal High Stability

The modem can be equipped with a 5×10^{-8} or better Stability Frequency Reference as an add-on enhancement. This is a factory upgrade only.

A.4 DC Input Prime Power

Allows for an optional DC Input Power Source.

A.5 ASI/RS-422 Parallel

ASI, Serial, BNC (Female)
DVB/M2P, Parallel, RS-422, DB-25 (Female)

A.6 ASI/LVDS Parallel

ASI, Serial, BNC (Female)
DVB/M2P, Parallel, LVDS, DB-25 (Female)

A.7 HSSI

High-Speed Serial Interface 50-Pin SCSI-2 Type Connector. Complies with Cisco Systems in HSSI Design Specification, Revision 3.0.

A.8 Ethernet Data Interface

Four RJ-45, Auto-Crossover, Auto-Sensing, 10/100 Ethernet Data Ports. Complies with IEEE 802.3 and IEEE 802.3u.

A.9 Gigi Ethernet Data Interface

Three RJ-45, Auto-Crossover, Auto-Sensing, 10/100/1000 Ethernet Data Ports. Complies with IEEE 802.3 and IEEE 802.3u.

A.10 HSSI / G.703

High-Speed Serial Interface 50-Pin SCSI-2 Type Connector. Complies with Cisco Systems in HSSI Design Specification, Revision 3.0. The G.703 interface supports T1, E1, T2, E2 rates balanced or unbalanced. It does not support backward alarms.

A.11 HSSI / ETHERNET

High-Speed Serial Interface 50-Pin SCSI-2 Type Connector. Complies with Cisco Systems in HSSI Design Specification, Revision 3.0. Four RJ-45, Auto-Crossover, Auto-Sensing, 10/100 Ethernet Data Ports. Complies with IEEE 802.3 and IEEE 802.3u.

A.12 Turbo Product Code / Variable Reed-Solomon

The modem can be equipped with an optional TPC Codec Card (AS/5167). This card allows variable Reed-Solomon rates, Standard Turbo Codec, Legacy Turbo Codec and Sequential Codec Outer Code. This option must be installed at the factory and may require other options.

A.13 Combination Low-density Parity Check (LDPC) and TPC Codec

A plug-in daughter card (PLR6002) that can be factory-installed at the time of ordering or installed by the user in the field. This card supports Standard Turbo Codec and LDPC. This option is capable of supporting a full range of code rates/modulations and data rates up to 20 Mbps.

A.14 Customized Options

The modem may be customized for specific customer requirements. Most modifications or customization can be accomplished by means of firmware/software modifications. The following are examples of the types of customization available to the user:

- Customized Data Rates.
- Customized Scrambler/Descramblers.
- Customized Overhead Framing Structures.
- Customized Modulation Formats.
- Customized Uses for the ES-ES Overhead Channel.

Contact the Comtech EF Data Customer Service or Sales Department at (480) 333 2200 for all requests.

Appendix B. Front Panel Upgrade Procedure

B.1 Introduction

The Universal Satellite Modem offers the ability to perform field upgrades of the modem's feature set quickly and easily from the front panel. Purchased upgrades will become part of the modems permanent configuration. Demonstration upgrades will enable the optional features for a 30-day evaluation period.

B.2 Required Equipment

The Universal Satellite Modem is the only equipment required for this procedure.

B.3 Upgrade Procedure

The following paragraphs describe the procedure for permanently updating the feature set of the Universal Satellite Modem

1. The following steps allow users to quickly determine from the front panel whether or not the desired feature(s) are supported by the hardware currently installed in the modem.
 - a. From the modem's Main Menu, scroll right to the SYSTEM Menu.
 - b. Scroll down.
 - c. Scroll right to the HW/FW CONFIG Menu.
 - d. Scroll down
 - e. Scroll right to the FEATURES Menu.
 - f. Scroll down.
 - g. Scroll right to the UPGRADE LIST Menu.
 - h. Scroll down.
 - i. Scroll right through the available list of options.

The top line identifies the options and the second line identifies the following options status:

INSTALLED indicates that the option is already available as part of the modems feature set.

HW & KEY REQ indicates that additional hardware is required to support the option.

Contact your Comtech sales representative for more information regarding the required hardware upgrade.

KEY CODE REQ indicates that the desired option is available as a front panel upgrade.

2. Contact Comtech with the Unit ID and Desired Upgrades. The modem's Unit ID can be found on the front panel as follows:
 - a. From the modem's Main Menu, scroll right to the SYSTEM Menu.
 - b. Scroll down.
 - c. Scroll right to the HW/FW CONFIG Menu.
 - d. Scroll down.
 - e. Scroll right to the FEATURES Menu.
 - f. Scroll down

The value displayed on the top line of this menu is the 12-digit Unit ID. It is displayed as on the front panel of the modem as 3 sets of 4 digits in a dot-delineated format as follows:

1 2 3 4 . 1 2 3 4 . 1 2 3 4

Your Comtech EF Data sales representative will ask you for this number along with your desired feature set upgrades when placing your order.

3. Once your order has been processed, you will be issued a 12-digit feature set upgrade code. This code is only good on the modem for which it was ordered. To enter this code from the front panel, perform the following:
 - a. From the modem's Main Menu, scroll right to the SYSTEM Menu.
 - b. Scroll down.
 - c. Scroll right to the HW/FW CONFIG Menu.
 - d. Scroll down.
 - e. Scroll right to the FEATURES Menu.
 - f. Scroll down.

The value displayed on the top line of this menu is the 12-digit Unit ID. It is displayed on the front panel of the modem as 3 sets of 4 digits in a dot-delineated format indicated in Step 2. The second line is the data entry area and is displayed as 3 sets of 4 underscores in a dot-delineated format.

- g. Press <ENTER>. A cursor will begin flashing in the data entry area.
- h. Using the numeric keypad, enter your 12-digit upgrade code.
- i. Press <ENTER>.

If the code entered is correct, the display will display **CODE ACCEPTED**, otherwise the **INVALID CODE** will be displayed..



Care should be taken to insure that the upgrade code is entered properly. After three unsuccessful attempts to enter a code, the front panel upgrade and demonstration capability will be locked out and it will be necessary to cycle power on the modem in order to continue.

B.4 Demonstration Procedure

The procedure for enabling a 30-day demo of the options is similar to the procedure used for permanently updating the modems feature set. The one big difference being that at the end of 30 days, the demo features will automatically be disabled and the modem will revert back to its permanent configuration.



At the end of the demonstration period, when the modem reverts back to its permanent configuration an interrupt in traffic will occur, regardless of whether or not a demo enabled features was being run at the time. In addition, operator intervention may be required to restore the data paths. In order to avoid this interruption in service, the user can cancel the demonstration at any time by following the instructions outlined in the section on "Canceling Demonstration Mode."

1. The following steps allow users to quickly determine from the front panel whether or not the desired feature(s) are supported by the hardware currently installed in the modem.
 - a. From the modem's Main Menu, scroll right to the SYSTEM Menu.
 - b. Scroll down.
 - c. Scroll right to the HW/FW CONFIG Menu.
 - d. Scroll down.
 - e. Scroll right to the FEATURES Menu.
 - f. Scroll down.
 - g. Scroll right to the UPGRADE LIST Menu.
 - h. Scroll down.
 - i. Scroll right through the available list of options.

The top line identifies the options and the second line identifies the options status.

INSTALLED indicates that the option is already available as part of the modems feature set.

HW & KEY REQ indicates that additional hardware is required to support the option. Contact your Comtech EF Data sales representative for more information regarding the required hardware upgrade.

KEY CODE REQ indicates that the desired option can be enabled as a demonstration from the front panel.

2. Contact Comtech with the Unit ID and Request a Demonstration.

The modem's Unit ID can be found on the front panel as follows:

- a. From the modem's Main Menu, scroll right to the SYSTEM Menu.
- b. Scroll down.
- c. Scroll right to the HW/FW CONFIG Menu.
- d. Scroll down.
- e. Scroll right to the FEATURES Menu.
- f. Scroll down.

The value displayed on the top line of this menu is the 12-digit Unit ID. It is displayed as on the front panel of the modem as 3 sets of 4 digits in a dot-delineated format as follows:

1 2 3 4 . 1 2 3 4 . 1 2 3 4

Your Comtech EF Data sales representative will ask you for this number along with the features you wish to demo.

3. Once your order has been processed, you will be issued a 12-digit demonstration code. This code can only be used one time and it is only good on the modem for which it was originally requested. To enter this code from the front panel, perform the following:

- a. From the modem's Main Menu, scroll right to the SYSTEM Menu.
- b. Scroll down.
- c. Scroll right to the HW/FW CONFIG Menu.
- d. Scroll down.
- e. Scroll right to the FEATURES Menu.
- f. Scroll down.

The value displayed on the top line of this menu is the 12-digit Unit ID. It is displayed on the front panel of the modem as 3 sets of 4 digits. The second line is the data entry area and is displayed as 3 sets of 4 underscores in a dot-delineated format.

Press <ENTER> and a cursor will begin flashing in the data entry area

Using the numeric keypad, enter your 12-digit demonstration code
Press <ENTER>.

If the code entered is correct, the display will display CODE ACCEPTED, otherwise the display will read INVALID CODE.



Care should be taken to insure that the demonstration code is entered properly. After three unsuccessful attempts to enter a code, the front panel upgrade and demonstration capability will be locked out and it will be necessary to cycle power on the modem in order to continue.

B.4.1 Running in Demonstration Mode

Because of the possible interruption in traffic when the demonstration mode expires, several indicators are used to inform an operator that the modem is indeed, operating in demonstration mode. The most obvious of these is that the remote LED is flashing.

A second indication can be found on the Features Menu as follows:

1. From the modem's Main Menu, scroll right to the SYSTEM Menu.
2. Scroll down.
3. Scroll right to the HW/FW CONFIG Menu.
4. Scroll down.
5. Scroll right to the FEATURES Menu. The second line will display DEMO.

A third indication can be found in the upgrade list as follows:

1. From the FEATURES Menu.
2. Scroll down.
3. Scroll right to the UPGRADE LIST Menu.
4. Scroll down.
5. Scroll right through the available list of options.

The top line identifies the options and the second line identifies the options status.

DEMO MODE indicates that the option is has been temporarily activated and is now available for evaluation as part of the modems feature set.

At the end of the demonstration period, the modem will revert back to its permanent configuration. When it does, an interrupt in traffic will occur, regardless of whether or not a demo enabled features was being run at the time. In addition, operator intervention may be required to restore the data paths. In order to avoid this interruption in service, the user can cancel the demonstration at any time by following the instructions outlined in the section on Canceling Demonstration Mode.

B.4.2 Canceling Demonstration Mode

At any time, a demonstration may be canceled and have the modem return to its normal operation. Once the demonstration has been canceled, it cannot be restarted using the old demonstration code. In order to restart a demonstration, it will be necessary to obtain a new demonstration code.

To cancel a demonstration from the front panel, perform the following:

1. From the modem's Main Menu, scroll right to the SYSTEM Menu.
2. Scroll down.
3. Scroll right to the HW/FW CONFIG Menu.
4. Scroll down.
5. Scroll right to the FEATURES Menu.
6. Scroll down.

The value displayed on the top line of this menu is the 12-digit Unit ID. It is displayed on the front panel of the modem as 3 sets of 4 digits in a dot-delineated format indicated in section 4.2. The second line is the data entry area and is displayed as 3 sets of 4 underscores in a dot-delineated format.

Press <ENTER> and a cursor will begin flashing in the data entry area

Using the numeric keypad, enter 0000 0000 0000

Press <ENTER>.

The modem will immediately terminate the demonstration and the feature set will revert back to the permanent configuration.

The Mod and Demod Test LED's will stop flashing.

Appendix C. Carrier Control

C.1 States

The transmitter will turn off the carrier output automatically when the modem determines there is a major alarm. This is done to prevent the carrier from outputting an unknown spectrum and possibly disturbing adjacent carriers. This automatic drop of the carrier can be overridden by masking the alarm that is causing the fault. This will keep the modulator output spectrum transmitting, even when the fault occurs. The following Carrier Control states are available:

- Carrier **OFF**
- Carrier **ON**
- Carrier **AUTO**
- Carrier **VSAT**
- Carrier **RTS**

C.2 Carrier Off

Modulator output is disabled.

C.3 Carrier On

Modulator output is turned off before reprogramming modulator functions that may alter the output spectrum through the front panel, and the user is required to enter "Yes" to re-enable output after the change. When using the terminal, the modulator is turned off while re-programming modulator functions that may alter the output spectrum, and the user is required to manually turn on the output after the reprogramming.

C.4 Carrier Auto

Modulator output is turned off before reprogramming modulator functions that may alter the output spectrum through the front panel, but the output is automatically turned on after the change. When using the terminal, the modulator is turned off while re-programming modulator functions that may alter the output spectrum, and but the output is automatically turned on after the change.

C.5 Carrier VSat

Modulator output is turned off before reprogramming modulator functions that may alter the output spectrum through the front panel, and the user is required to enter “Yes” to re-enable output after the change. When using the terminal, the modulator is turned off while reprogramming modulator functions that may alter the output spectrum, and the user is required to manually turn on the output after the reprogramming (same as “Carrier On”). Additionally “VSat” mode disables the modulators output when the modems demodulator does not have signal lock. When signal lock returns to the demodulator, the modulator turns the carrier back on.

C.6 Carrier RTS

Modulator output is turned off before reprogramming modulator functions that may alter the output spectrum through the front panel, and the user is required to enter “Yes” to re-enable output after the change. When using the terminal, the modulator is turned off while reprogramming modulator functions that may alter the output spectrum, and the user is required to manually turn on the output after the reprogramming (same as “Carrier On”). Additionally “RTS” (Request To Send) mode enables the modulator’s output based on the RTS lead of the data interface. When RTS is enabled on the data interface, the modulator turns on the carrier, when the RTS is disabled the modulator turns off the carrier.

Appendix D. Strap Codes

D.1 Strap Codes

The Strap Code is a quick set key that sets many of the modem parameters. For quick setup of the modem, Strap Codes are very helpful. When a Strap Code is entered, the modem is automatically configured for the code's corresponding data rate, overhead, code rate, framing, scrambler type and modulation. An example of how to set a strap code follows:

Example: At the Front Panel <Modulator> Menu, depress '↓', then move '→' to the 'Strap Code' Submenu and enter #16. The modem will be automatically configured to the parameters shown below in the highlighted row 'Strap Code 16'.

Use the Strap Code Guide (Table D-1) for available strap codes.

Table D-1. Strap Codes										
Dis = Disable										
Strap Code (Decimal)	Data Rate (Kbps)	Overhead	Code Rate	Type	Framing Type	Scrambler Type	Drop and Insert	Reed-Solomon	Modulation	Mode
1	64	16/15	1/2	VIT	IBS	IBS	Dis	Dis	QPSK	IBS
2	128	16/15	1/2	VIT	IBS	IBS	Dis	Dis	QPSK	IBS
3	256	16/15	1/2	VIT	IBS	IBS	Dis	Dis	QPSK	IBS
5	384	16/15	1/2	VIT	IBS	IBS	Dis	Dis	QPSK	IBS
6	512	16/15	1/2	VIT	IBS	IBS	Dis	Dis	QPSK	IBS
9	768	16/15	1/2	VIT	IBS	IBS	Dis	Dis	QPSK	IBS
4	1536	16/15	1/2	VIT	IBS	IBS	Dis	Dis	QPSK	IBS
10	1920	16/15	1/2	VIT	IBS	IBS	Dis	Dis	QPSK	IBS
8	2048	16/15	1/2	VIT	IBS	IBS	Dis	Dis	QPSK	IBS
12	2048	16/15	1/2	VIT	IBS	IBS	Dis	Dis	QPSK	CNT
16	1544	96K	3/4	VIT	IDR	V.35 (IESS)	Dis	Dis	QPSK	IDR
32	2048	96K	3/4	VIT	IDR	V.35 (IESS)	Dis	Dis	QPSK	IDR
64	6312	96K	3/4	VIT	IDR	V.35 (IESS)	Dis	Dis	QPSK	IDR

Table D-1. Strap Codes										
Dis = Disable										
Strap Code (Decimal)	Data Rate (Kbps)	Overhead	Code Rate	Type	Framing Type	Scrambler Type	Drop and Insert	Reed-Solomon	Modulation	Mode
128	8448	96K	3/4	VIT	IDR	V.35 (IESS)	Dis	Dis	QPSK	IDR
24	56	1	1/2	VIT	NONE	V.35 (IESS)	Dis	Dis	QPSK	CNT
33	56	1	3/4	VIT	NONE	V.35 (IESS)	Dis	Dis	QPSK	CNT
34	64	1	1/2	VIT	NONE	V.35 (IESS)	Dis	Dis	QPSK	CNT
36	64	1	3/4	VIT	NONE	V.35 (IESS)	Dis	Dis	QPSK	CNT
40	128	1	1/2	VIT	NONE	V.35 (IESS)	Dis	Dis	QPSK	CNT
48	128	1	3/4	VIT	NONE	V.35 (IESS)	Dis	Dis	QPSK	CNT
65	256	1	1/2	VIT	NONE	V.35 (IESS)	Dis	Dis	QPSK	CNT
66	256	1	3/4	VIT	NONE	V.35 (IESS)	Dis	Dis	QPSK	CNT
68	320	1	1/2	VIT	NONE	V.35 (IESS)	Dis	Dis	QPSK	CNT
72	320	1	3/4	VIT	NONE	V.35 (IESS)	Dis	Dis	QPSK	CNT
80	384	1	1/2	VIT	NONE	V.35 (IESS)	Dis	Dis	QPSK	CNT
96	384	1	3/4	VIT	NONE	V.35 (IESS)	Dis	Dis	QPSK	CNT
129	512	1	1/2	VIT	NONE	V.35 (IESS)	Dis	Dis	QPSK	CNT
130	512	1	3/4	VIT	NONE	V.35 (IESS)	Dis	Dis	QPSK	CNT
132	768	1	1/2	VIT	NONE	V.35 (IESS)	Dis	Dis	QPSK	CNT
136	768	1	3/4	VIT	NONE	V.35 (IESS)	Dis	Dis	QPSK	CNT
144	896	1	1/2	VIT	NONE	V.35 (IESS)	Dis	Dis	QPSK	CNT
44	896	1	3/4	VIT	NONE	V.35 (IESS)	Dis	Dis	QPSK	CNT
7	1344	1	1/2	VIT	NONE	V.35 (IESS)	Dis	Dis	QPSK	CNT
11	1344	1	3/4	VIT	NONE	V.35 (IESS)	Dis	Dis	QPSK	CNT
13	1536	1	1/2	VIT	NONE	V.35 (IESS)	Dis	Dis	QPSK	CNT
14	1536	1	3/4	VIT	NONE	V.35 (IESS)	Dis	Dis	QPSK	CNT
19	1544	1	1/2	VIT	NONE	V.35 (IESS)	Dis	Dis	QPSK	CNT
21	1544	1	3/4	VIT	NONE	V.35 (IESS)	Dis	Dis	QPSK	CNT
22	1920	1	1/2	VIT	NONE	V.35 (IESS)	Dis	Dis	QPSK	CNT
25	1920	1	3/4	VIT	NONE	V.35 (IESS)	Dis	Dis	QPSK	CNT
26	2048	1	1/2	VIT	NONE	V.35 (IESS)	Dis	Dis	QPSK	CNT
28	2048	1	3/4	VIT	NONE	V.35 (IESS)	Dis	Dis	QPSK	CNT
37	2368	1	1/2	VIT	NONE	V.35 (IESS)	Dis	Dis	QPSK	CNT
38	2368	1	3/4	VIT	NONE	V.35 (IESS)	Dis	Dis	QPSK	CNT
41	48	1	1/2	VIT	NONE	V.35 (IESS)	Dis	Dis	QPSK	CNT
160	1544	965/1024	1/2	VIT	IBS	IBS	Dis	Dis	QPSK	IBS

Table D-1. Strap Codes										
Dis = Disable										
Strap Code (Decimal)	Data Rate (Kbps)	Overhead	Code Rate	Type	Framing Type	Scrambler Type	Drop and Insert	Reed-Solomon	Modulation	Mode
52	1920	16/15	3/4	VIT	IBS	IBS	Dis	Dis	QPSK	IBS
69	6312	1	3/4	VIT	NONE	V.35 (IESS)	Dis	Dis	QPSK	CNT
70	8448	1	3/4	VIT	NONE	V.35 (IESS)	Dis	Dis	QPSK	CNT
73	3152	1	1/2	VIT	NONE	V.35 (IESS)	Dis	Dis	QPSK	CNT
74	3152	1	3/4	VIT	NONE	V.35 (IESS)	Dis	Dis	QPSK	CNT
76	3264	1	1/2	VIT	NONE	V.35 (IESS)	Dis	Dis	QPSK	CNT
81	3264	1	3/4	VIT	NONE	V.35 (IESS)	Dis	Dis	QPSK	CNT
88	512	16/15	3/4	VIT	IBS	IBS	Dis	Dis	QPSK	IBS
97	1024	1	1/2	VIT	CNT	V.35 (IESS)	Dis	Dis	QPSK	CNT
98	1024	1	3/4	VIT	CNT	V.35 (IESS)	Dis	Dis	QPSK	CNT
112	64	16/15	3/4	VIT	IBS	IBS	Dis	Dis	QPSK	IBS
131	128	16/15	3/4	VIT	IBS	IBS	Dis	Dis	QPSK	IBS
133	256	16/15	3/4	VIT	IBS	IBS	Dis	Dis	QPSK	IBS
134	192	16/15	1/2	VIT	IBS	IBS	Dis	Dis	QPSK	CNT
137	192	16/15	3/4	VIT	IBS	IBS	Dis	Dis	QPSK	CNT
138	320	16/15	1/2	VIT	IBS	IBS	Dis	Dis	QPSK	CNT
140	320	16/15	3/4	VIT	IBS	IBS	Dis	Dis	QPSK	CNT
145	384	16/15	3/4	VIT	IBS	IBS	Dis	Dis	QPSK	IBS
100	448	16/15	1/2	VIT	IBS	IBS	Dis	Dis	QPSK	CNT
146	448	16/15	3/4	VIT	IBS	IBS	Dis	Dis	QPSK	CNT
104	576	16/15	1/2	VIT	IBS	IBS	Dis	Dis	QPSK	CNT
148	576	16/15	3/4	VIT	IBS	IBS	Dis	Dis	QPSK	CNT
152	640	16/15	1/2	VIT	IBS	IBS	Dis	Dis	QPSK	CNT
161	640	16/15	3/4	VIT	IBS	IBS	Dis	Dis	QPSK	CNT
162	704	16/15	1/2	VIT	IBS	IBS	Dis	Dis	QPSK	CNT
164	704	16/15	3/4	VIT	IBS	IBS	Dis	Dis	QPSK	CNT
168	768	16/15	3/4	VIT	IBS	IBS	Dis	Dis	QPSK	IBS
193	832	16/15	1/2	VIT	IBS	IBS	Dis	Dis	QPSK	CNT
194	832	16/15	3/4	VIT	IBS	IBS	Dis	Dis	QPSK	CNT
196	896	16/15	1/2	VIT	IBS	IBS	Dis	Dis	QPSK	CNT
208	896	16/15	3/4	VIT	IBS	IBS	Dis	Dis	QPSK	CNT
224	960	16/15	1/2	VIT	IBS	IBS	Dis	Dis	QPSK	CNT
15	960	16/15	3/4	VIT	IBS	IBS	Dis	Dis	QPSK	CNT

Table D-1. Strap Codes										
Dis = Disable										
Strap Code (Decimal)	Data Rate (Kbps)	Overhead	Code Rate	Type	Framing Type	Scrambler Type	Drop and Insert	Reed-Solomon	Modulation	Mode
23	1024	16/15	1/2	VIT	IBS	IBS	Dis	Dis	QPSK	IBS
27	1024	16/15	3/4	VIT	IBS	IBS	Dis	Dis	QPSK	IBS
29	1536	16/15	3/4	VIT	IBS	IBS	Dis	Dis	QPSK	IBS
30	1088	16/15	1/2	VIT	IBS	IBS	Dis	Dis	QPSK	IBS
39	1088	16/15	3/4	VIT	IBS	IBS	Dis	Dis	QPSK	CNT
43	1152	16/15	1/2	VIT	IBS	IBS	Dis	Dis	QPSK	CNT
46	1152	16/15	3/4	VIT	IBS	IBS	Dis	Dis	QPSK	CNT
51	1216	16/15	1/2	VIT	IBS	IBS	Dis	Dis	QPSK	CNT
53	1216	16/15	3/4	VIT	IBS	IBS	Dis	Dis	QPSK	CNT
54	1280	16/15	1/2	VIT	IBS	IBS	Dis	Dis	QPSK	CNT
57	1280	16/15	3/4	VIT	IBS	IBS	Dis	Dis	QPSK	CNT
58	1344	16/15	1/2	VIT	IBS	IBS	Dis	Dis	QPSK	CNT
67	1408	16/15	1/2	VIT	IBS	IBS	Dis	Dis	QPSK	CNT
71	1408	16/15	3/4	VIT	IBS	IBS	Dis	Dis	QPSK	CNT
75	1472	16/15	1/2	VIT	IBS	IBS	Dis	Dis	QPSK	CNT
77	1472	16/15	3/4	VIT	IBS	IBS	Dis	Dis	QPSK	CNT
78	1600	16/15	1/2	VIT	IBS	IBS	Dis	Dis	QPSK	CNT
83	1600	16/15	3/4	VIT	IBS	IBS	Dis	Dis	QPSK	CNT
85	1664	16/15	1/2	VIT	IBS	IBS	Dis	Dis	QPSK	CNT
86	1664	16/15	3/4	VIT	IBS	IBS	Dis	Dis	QPSK	CNT
89	1728	16/15	1/2	VIT	IBS	IBS	Dis	Dis	QPSK	CNT
90	1728	16/15	3/4	VIT	IBS	IBS	Dis	Dis	QPSK	CNT
92	1792	16/15	1/2	VIT	IBS	IBS	Dis	Dis	QPSK	CNT
99	1792	16/15	3/4	VIT	IBS	IBS	Dis	Dis	QPSK	CNT
101	2048	16/15	3/4	VIT	IBS	IBS	Dis	Dis	QPSK	IBS
102	1856	16/15	1/2	VIT	IBS	IBS	Dis	Dis	QPSK	CNT
105	1856	16/15	3/4	VIT	IBS	IBS	Dis	Dis	QPSK	CNT
106	2048	16/15	3/4	VIT	IBS	IBS	Dis	Dis	QPSK	CNT
120	1544	965/1024	3/4	VIT	IBS	IBS	Dis	Dis	QPSK	IBS
135	1984	16/15	1/2	VIT	IBS	IBS	Dis	Dis	QPSK	CNT
139	1984	16/15	3/4	VIT	IBS	IBS	Dis	Dis	QPSK	CNT
45	3088	1	1/2	VIT	NONE	V.35 (IESS)	Dis	Dis	QPSK	CNT
141	3088	1	3/4	VIT	NONE	V.35 (IESS)	Dis	Dis	QPSK	CNT

Table D-1. Strap Codes										
Dis = Disable										
Strap Code (Decimal)	Data Rate (Kbps)	Overhead	Code Rate	Type	Framing Type	Scrambler Type	Drop and Insert	Reed-Solomon	Modulation	Mode
176	4000	1	1/2	VIT	NONE	V.35 (IESS)	Dis	Dis	QPSK	CNT
116	4000	1	3/4	VIT	NONE	V.35 (IESS)	Dis	Dis	QPSK	CNT
60	1344	16/15	3/4	VIT	IBS	IBS	Dis	Dis	QPSK	CNT

D.2 Sample Applications

The following section provides brief application notes for operating the modem and explains by example how to configure the modem for some of the most popular configurations.

The following information illustrates the allowable combinations for Mode and Data Rate.

Allowable Combinations: Mode/Rate/Framing.

IDR:

8.448 Mbps	3/4, 7/8 Rate FEC
6.312 Mbps	1/2, 3/4, 7/8 Rate FEC
2.048 Mbps	1/2, 3/4, 7/8 Rate FEC
1.544 Mbps or Below	1/2, 3/4, 7/8 Rate FEC

IBS:

2.048 Mbps or below	1/2, 3/4, 7/8 Rate
---------------------	--------------------

Closed Network:

8.448:	96 Kb Framing or No Framing, 3/4, 7/8 Rate FEC
6.312:	96 Kb Framing or No Framing, 1/2, 3/4, 7/8 Rate FEC
2.048:	96 Kb Framing or 1/15 Framing or No Framing, 1/2, 3/4, 7/8 Rate FEC
1.544:	96 Kb Framing or 1/15 Framing or No Framing, 1/2, 3/4, 7/8 Rate FEC
Any Rate 2.048 & lower:	1/15 Framing or No Framing, 1/2, 3/4, 7/8 Rate FEC

D.2.1 Operational Case Examples



For best results always begin setup by setting the data rate to 512 Kbps. This data rate is applicable for all modes and as such provides a convenient launch point for setting up the modem. Any mode of operation can be entered from this starting point.

Case 1: IDR 8.448 Mbps, 3/4 Rate Viterbi

Starting with the Data Rate = 512 Kbps

Modulator:

Method 1 -

Under Interface Menu: Set Interface type
Set Tx clock selection

Set mode to IDR

Under Mod Data Menu: Set code rate to 3/4 VIT
Set data rate for 8448000

Under Mod IF Menu: Set desired Tx frequency and power level
Turn IF ON

Method 2 -

Under Interface Menu: Set Interface type
Set Tx clock selection

Set Mod strap code to: 128

Under Mod IF Menu: Set desired Tx frequency and power level
Turn IF on

Demodulator:**Method 1 -**

Under Interface Menu: Set Interface type
Set Buff clock selection
Set Buffer Size

Set mode to IDR
Under Demod IF Menu: Set desired Rx frequency
Under Demod data Menu: Set code rate to 3/4 VIT
Set data rate for 8448000

Method 2 -

Under Interface Menu: Set Interface type

Set Demod strap code to 128

Set Buff clock selection
Set Buffer Size

Under Demod IF Menu, set desired Rx frequency

Case 2: IBS 1.544 Mbps, 3/4 Rate Viterbi

Starting with the Data Rate – 512 Kbps

Modulator:**Method 1 -**

Under Interface Menu: Set Interface type
Set Tx clock selection

Set Framing to 1/15
Set mode to IBS
Under Mod Data Menu: Set code rate to 3/4 VIT
Set data rate for 1544000

Under Mod IF Menu: Set desired Tx frequency and power level
Turn IF ON

Method 2 -

Under Interface Menu: Set Interface type
Set Tx clock selection

Set Mod strap code to: 120
Under Mod IF Menu: Set desired Tx frequency and power level
Turn IF on

Demodulator:**Method 1 -**

Under Interface Menu:

Set Interface type
Set Buff clock selection
Set Buffer Size

Set Framing to 1/15:

Set mode to IBS:

Under Demod IF Menu:

Set desired Rx frequency

Under Demod Data Menu:

Set code rate to 3/4 VIT

Set data rate for 1544000

Under Interface Menu:

Set Interface type
Set Buff clock selection
Set Buffer Size**Method 2 -**

Under Interface Menu:

Set Interface type
Set Buff clock selection
Set Buffer Size

Set Demod strap code to: 120

Under Demod IF Menu:

Set desired Rx frequency

Case 3: Closed Network, 3/4 Rate Viterbi, IBS Overhead

Starting with the Data Rate = 512 Kbps

Modulator:**Method 1 -**

Under Interface Menu:

Set Interface type
Set Tx clock selection

Set mode to IDR:

Under Mod Data Menu:

Set code rate to 3/4 VIT

Set Framing for 1/15

Under Mod IF Menu:

Set desired Tx frequency and power level
Turn IF ON**Method 2 -**

Under Interface Menu:

Set Interface type
Set Tx clock selection

Set Mod strap code to: 101

Under Mod IF Menu:

Set desired Tx frequency and power level
Turn IF on

Demodulator:**Method 1 -**

Under Interface Menu:

Set Interface type
Set Buff clock selection
Set Buffer Size

Set mode to: Closed Net

Under Demod IF Menu: Set desired Rx frequency

Under Demod data Menu:

Set code rate to 3/4 VIT
Set Framing for 1/15**Method 2 -**

Under Interface Menu:

Set Interface type
Set Buff clock selection
Set Buffer Size

Set Demod strap code to: 101

Under Demod IF Menu: Set desired Rx frequency

Case 4: Loop Timing Example**Method 1 -**

Under Interface Menu:

Under Tx Setup Menu:
Set INTF to RS-422
Set SCT Source to SCR
Set Tx Clock to SCTE
Set mode to IBS**Method 2 -**

Under Interface Menu:

Under Tx Setup Menu:
Set INTF to RS-422
Set SCT Source to SCR
Set Tx Clock to SCTE

Set mode to Closed Net

BLANK PAGE

Appendix E.TCP/IP Ethernet Setup

E.1 Introduction

The modem supports SNMP, FTP protocols and the Web Browser. Utilization of the protocols is dependent upon proper set up of the TCP-IP menus. This document is to be used only as a guideline for setting up the TCP-IP menus. Contact the IT manager for proper guidance to ensure setup is successful. For additional information on the various WEB or SNMP configurations and descriptions refer to the Remote Protocol Manual (MN-DMDREMOTEO.P).

E.2 TCP/IP Network Configuration

Using the Front Panel display and arrow keys, scroll thru the System menu until the TCP / IP sub menu is displayed. Each unit requires proper configuration with the correct network settings. Contact the IT manager for a valid IP address mask, Modem, server and router IP addresses.

Enter into the TCP / IP menu and the following Sub menus will appear, however the order may vary.

1. **Boot Mode:** This allows for the selection of the operating boot mode for the TCP / IP. Several selections are available and are described below. When configuring the modem for Web Browser, Boot Mode must be set to "NON-VOL". A brief description of the available selections are:
 - a. **Default:** If the Ethernet interface is not to be used, select this mode. No IP Address or mask changes will be allowed while in this mode of operation. The following parameters will be set and will not change until the boot mode is changed. The IP addresses are non accessible addresses.

• IP MASK	255.000.000.000
• MODEM IP ADDR	010.000.000.001
• SERVER IP ADDR	010.001.001.001
• ROUTER IP ADDR	010.000.001.001
 - b. **BOOTp:** When enabled, at boot time, the modem will use the Bootp Protocol to automatically get names, masks, and IP Addresses of the modem, router, and server from the Network Manager. This should be consistent with the tag expected by the users Bootp Server (see the next menu selection for setting the BOOTp TAG). If Bootp is not enabled, the modem will ignore the BOOTp Tag setting.
 - c. **NON-VOL:** This will allow for setting up all required IP Addresses and will store the information to the non-volatile memory. Upon power cycle, the modem will restore the saved settings into the correct fields.

- d. **IP TEST:** The IP Test selection is similar in behavior to the Default selection. When enabled, the following preset parameters will be programmed and will not change until the selection is changed. To edit these parameters, change the boot mode to NON-VOL.

▪ IP MASK	255.255.255.000
▪ MODEM IP ADDR	192.168.000.238
▪ SERVER IP ADDR	192.168.000.101
▪ ROUTER IP ADDR	192.168.000.102



The modem is shipped from the factory with the Boot Mode configured as Default. Verify that the Boot Mode is set for Default. To access the unit via the Ethernet port, set the selection to IP TEST. This will set the IP parameter to an accessible address. If user wants to utilize an alternate address, user must set the selection to NON-VOL. As an example, we will use a new modem IP address of 172.018.100.205 for the remaining of the TCP-IP setup procedure. Contact the IT manager for proper guidance to ensure setup is successful.

2. **BOOT SERVER TAG:** This allows for the selection of the operating boot tag when operating in the BOOTp Mode. The default setting of 206 is automatically selected when the boot mode is set to 'DEFAULT' (factory preset mode).
3. **MODEM HOST:** This displays the unit Host name, this is a read only display.
4. **IP ADDR MASK:** This will allow for the entry of the IP Address Mask. This will need to be entered based on the Network settings. Refer to your IP Administrator if you do not know this address for the correct address setting. Example IP Address Mask setting: 255.255.000.000.
5. **MODEM IP ADDR:** This will allow for the entry of the Modem's individual network IP Address. Each device on the network will have a unique address. Refer to the IT administrator for the correct address setting. Example Modem IP Address setting: 172.018.100.215.
6. **SERVER IP ADDR:** This allows for the setup of the Network Server IP Address. This section refers to the Host that will be used to optionally boot the modem on power-up and is the SNMP Trap Server. This IP Address needs to be consistent with the Modem IP Address. Broadcast and loop back addresses will not be allowed. Example Server IP Address setting: 172.018.004.250.
7. **ROUTER IP ADDR:** This allows for the setup of the Network Router IP Address. If a router is present on the local network, and it is to be used, this address must be consistent with the IP Address Mask and the subnet of the modem. If no router is present, then the address should be set to a foreign address. Broadcast and loop back addresses will not be allowed. Router not used example: Router IP Address setting: 010.000.001.001.
8. **MODEM EADDR:** This displays the Modem (Unit) Ethernet Address. The Modem Ethernet Address is configured at the factory. It is a unique Radyne equipment identifier Address. Example: 0010650903EB
9. **ETHER RATE:** This displays the current Ethernet port data rate. If multiple rates are available, then a selection can be made to specify the Ethernet port data rate (10BaseT). Example Ethernet port Data Rate: 10 MBPS/HD

E.3 Network Configuration Summary

If the above steps were followed and the information was entered, then the following would be the TCP / IP configuration summary for a 'no router specified' setup:

1. Boot Mode = NON-VOL
2. Bootp Server Tag = 206
3. Modem Host= DMDXX
4. IP Address Mask = 255.255.0.0
5. Modem IP Address = 172.18.100.215
6. Server IP Address = 172.18.4.250
7. Router IP Address = 010.000.001.001
8. Modem Ethernet Address= 0010650903EB
9. Ethernet Rate = 10 MBPS/HD

E.4 Ethernet Test

E.4.1 Connecting the Modem Ethernet Cable to a Network Link

1. **Connect the Network Switch (Hub) to the Modem Ethernet port (J9) using standard RJ-45 to RJ-45 10BaseT (CAT-5) Cables as shown below.**

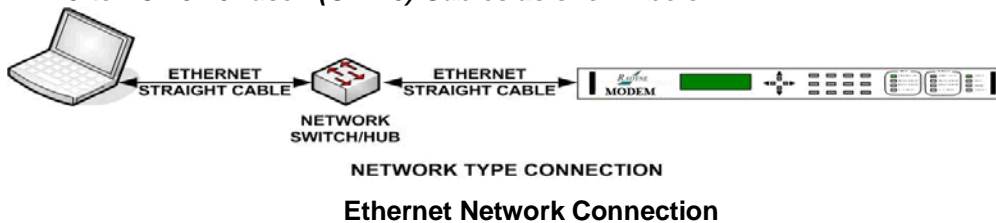

E.4.2 Connecting the Modem Ethernet Cable Directly to a Computer (without a Network)

The user can directly connect to the equipment without connecting to a network. This will often occur at remote sites where a network is not available. To connect, the user will need an Ethernet Crossover (Null) cable. The pinout for this cable is as follows,

RJ45 Connector A	RJ45 Connector B
Pin #1	Pin #3
Pin #2	Pin #6
Pin #3	Pin #1
Pin #4	Pin #4
Pin #5	Pin #5
Pin #6	Pin #2
Pin #7	Pin #7
Pin #8	Pin #8

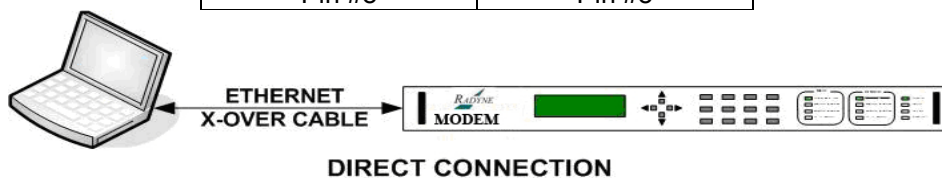

The Computer TCP/IP must be properly configured in order to obtain connectivity. The following set-up procedure can be used as a guide to aide in this setup. The following instructions apply only to Windows 2000 or XP Classic.

1. Click on the Start Button. Select Settings and click on the Control Panel Icon. Double click the Network Connections Icon.
2. Select the Local Area Connection icon for the applicable Ethernet adapter. Usually it is the first Local Area Connection listed. Double click the Local Area Connection. Click on the Properties icon.

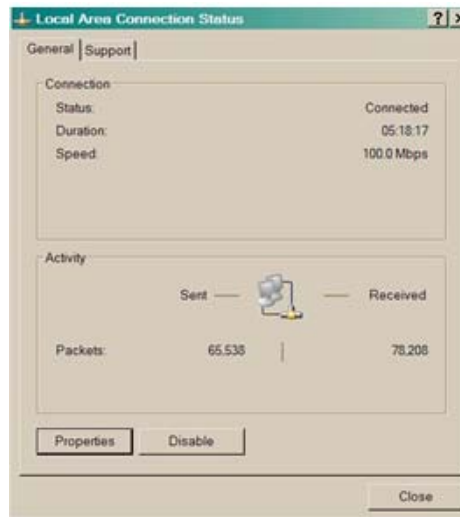

Local Area Connection Status Box

3. Make sure that the box next to the Internet Protocol (TCP/IP) is checked. Highlight Internet Protocol (TCP/IP) and click on the Properties button.

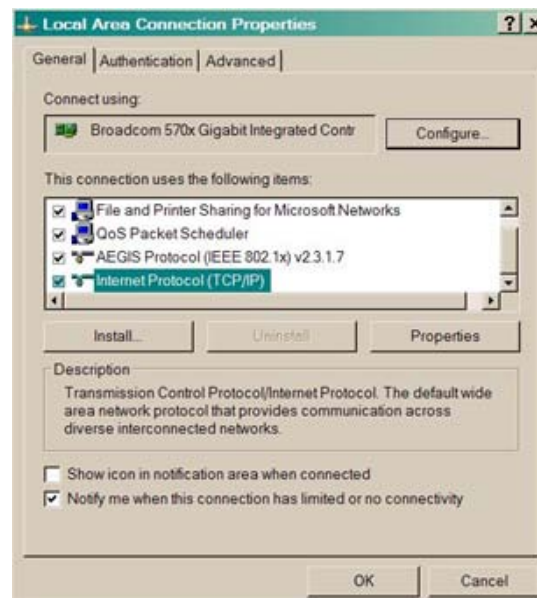

Local Area Connection Properties Box

4. Select "Use the following IP Address". Enter in the IP Address that is offset by 5 or so numbers from the equipment address (the computer and the equipment that it is connecting to cannot have identical addresses) and Subnet Mask (this is identical to the subnet mask programmed into the equipment) into the corresponding fields. Click the OK button to

complete the PC Configuration. Note: some computers may require that the computer be restarted for the changes to take effect.

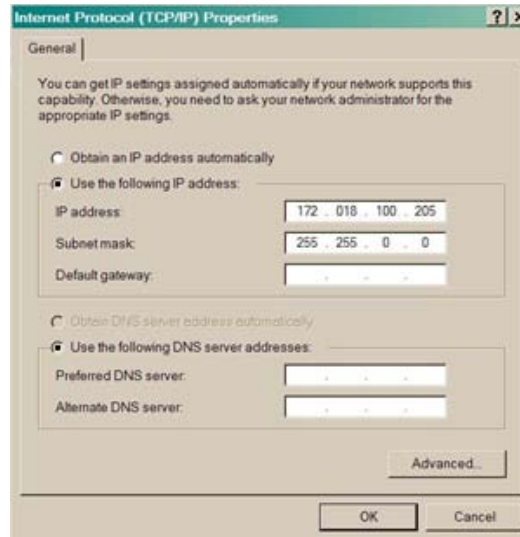

Internet Protocol (TCP/IP) Properties Box

5. To reconnect the computer to a network, select the “Obtain an IP address automatically” selection in the screen shown above.

E.4.3 Testing the Ethernet connection using the Ping Program (Optional)

Use the Ping command to report if the Host (Equipment) is correctly responding. Open the MSDOS Command Prompt and give a Ping command as shown in the following example.

1. Open MSDOS Command Prompt. The Screen will display:

```
Microsoft Windows XP [Version 5.1.2600]
(C) Copyright 1985-2001 Microsoft Corp.
```

2. At the Command Prompt Enter "ping 172.18.100.215" (Enter the IP Address of the equipment to be tested). The screen will display:

```
Microsoft Windows XP [Version 5.1.2600]
(C) Copyright 1985-2001 Microsoft Corp.
```

```
C:\> ping 172.18.100.215
```

3. If the ping is successful the screen will display:

```
C:\>ping 172.18.100.215
```

```
Pinging 172.18.100.215 with 32 bytes of data:
```

```
Reply from 172.18.100.215: bytes=32 time=109ms TTL=64
Reply from 172.18.100.215: bytes=32 time<1ms TTL=64
Reply from 172.18.100.215: bytes=32 time=2ms TTL=64
Reply from 172.18.100.215: bytes=32 time=123ms TTL=64
```

```
Ping statistics for 172.18.100.215:
```

```
Packets: Sent = 4, Received = 4, Lost = 0 (0% loss),
Approximate round trip times in milli-seconds:
Minimum = 0ms, Maximum = 123ms, Average = 58ms
```

4. If the ping is unsuccessful the screen will display:

```
C:\>ping 172.18.100.215
```

```
Pinging 172.18.100.215 with 32 bytes of data:
```

```
Request timed out.
Request timed out.
Request timed out.
Request timed out.
```

```
Ping statistics for 172.18.100.215:
```

```
Packets: Sent = 4, Received = 0, Lost = 4 (100% loss),
```

Check the following items that may lead to the unsuccessful response:

- a. Verify that the correct cables are connected to the Ethernet port and that they are secured.
- b. The Link Light is illuminated.
- c. The IP Address that is used matches the Modem's IP Address.
- d. The Server and Modem are on the same subnet.

Appendix F. WEB INTERFACE SETUP GUIDE

F.1 Introduction

The web interface lets Radyne products connect and communicate through the Ethernet port. The connection is a 10Base-T Ethernet connection.

You use the web interface to control and monitor the parameters and functions of these connected units.

To find out if the unit has the Web interface, use the front panel <SYSTEM> control screen and make sure that you can see the WEB submenu. If you do not see the WEB submenu, contact customer service for help.

See also:

Radyne Remote Operations, part number MN-DMDREMOTEOP

F.2 Setup

F.2.1 TCP-IP Menus



IMPORTANT

Before you use the web interface, make sure that the TCP-IP menus are set up correctly.

See also:

Appendix F, TCP-IP Ethernet Setup

F.2.2 IP Address



IMPORTANT

Before you set an IP address, contact the IT authority in your organization for help.

The BOOT MODE setting controls access to the IP address for the unit. The unit is shipped from the factory with the BOOT MODE set to DEFAULT (a fixed address that is not accessible).

To access the unit through the Ethernet port, set the Boot Mode to IP TEST (a fixed IP address that is accessible).

To use an alternate IP address, change the BOOT MODE to NON-VOL. You can program NON-VOL to any valid IP address.

F.3 Web Interface Security

Access rights and authentication parameters are stored in the web user database. Anyone who uses the web interface must have a user account in the web user database. A user account contains four parameters:

- User ID
- Access Group
- Authentication Password
- Web User

F.3.1 Default User Accounts

Initially, the web user database contains three factory-default user accounts. The parameters in those accounts are:

USER ID	Access Group	Authentication Password	Web User
USER 1	GUEST	guest	guest
USER 2	OPER	oper	oper
USER 3	ADMIN	admin	admin

F.3.2 User Account Data



IMPORTANT

All entries are case-sensitive.

Parameter	Character type	Maximum	Minimum	Restrictions
User ID	ASCII Printable Characters	13	0	None
Authentication Password	ASCII Printable Characters	13	0	None
Web User	ASCII Printable Characters	13	0	[CEFD1]None

Access Group	Access Level	Description
GUEST	View Only	Guests see most of the site and modem parameter settings.
OPER	Limited Access	Operators monitor and control modem parameters, and change their own authentication passwords.
ADMIN	Full Access	Administrators monitor and control modem parameters, change any user's name and authentication password, and modify IP network settings. This setting has full access to the entire site.
NO GROUP	No Access	These users do not have any access to the web interface.

F.1 User Account Setup

The front panel gives full administrative access to the parameters that control the unit, including web interface security.

Use the arrow keys to move through the menus and parameters:

SYSTEM ▼

WEB ▼

CONFIRMATION ▼

USER 1 ▼

ACCESS GROUP {GUEST, OPER, ADMIN, NO GROUP}

AUTH PASSWORD

USER RESET

USER 2 ▼

USER 3 ▼

**IMPORTANT**

All entries are case-sensitive.

To set up a User Account, do these steps:

1. Edit the User ID.
2. Edit the Access Group.
3. Edit the Authentication Password.

F.1.1 Edit the User ID.

1. Select the User ID.
2. Press ENTER.
3. Move the cursor to the first character.
4. Press CLEAR and the ► right button to delete the characters.
5. Use the direction buttons and numeric keys to enter the new User ID.
6. Press ENTER to save the change.

F.1.2 Edit the Access Group.

1. Select ACCESS GROUP.
2. Press ENTER.
3. Press the ▼ down button until you see the new Access Group.
4. Press ENTER to save the change.

F.1.3 Edit the Authentication Password.

1. Select AUTH PASSWORD.
2. Press ENTER.
3. Move the cursor to the first character.
4. Press CLEAR and the ► right button to delete the characters.
5. Use the direction buttons and numeric keys to enter the new authentication password.
6. Press ENTER to save the change.

F.2 Reset a User Account

Sometimes, it is necessary to reset a user account to the factory defaults. For example, a user account may be locked because of too many incorrect password attempts. Release the lock by resetting the user account. Then, set up the user account again.

To reset a User Account, do these steps:

1. Select the User ID.
 2. Press the ▼ down button.
 3. Press the ► right button until you see USER RESET.
 4. Press ENTER to reset the User Account.
1. **USER 1:** This will allow the operator to change the user name, assign the Access group, authorized password for "USER 1". Upon entering the following fields will be displayed:
 - a. **ACCESS GROUP:** This will allow the assignment of "No Group", "ADMIN", "OPER", or GUEST to USER 1.
 - b. **AUTH PASSWORD:** This will allow for the entry of the password for USER 1.
 - c. **USER RESET:** Using this command will allow the factory defaults (as listed in the table above) to be restored to USER 1. This can be used in the event that USER 1 is locked out due to password restriction.
 2. **USER 2:** This has the same menu structure as USER 1.
 3. **USER 3:** This has the same menu structure as USER 1.

Radyne's Web configuration allows for the support of 3 user profiles. These are configured through the 'PASSWORD/SETUP ACCESS section in the Web Browser.

F.3 Confirmation

You can enable or disable a confirmation prompt.

CONFIRMATION	ENABLED – causes a prompt that asks you to confirm or cancel changes. DISABLED – no prompt occurs. Changes are effective immediately after you press ENTER.
--------------	--

F.4 Equipment Website

Once you know that the modem is accessible through the internet, do these steps:

1. Start the internet browser.
2. Type the modem's IP address in the address field, and then press [Enter].

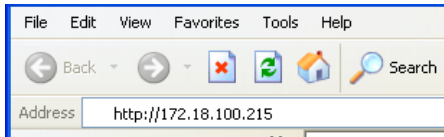

The WEB browser equipment introduction page opens.



Figure F-1. WEB Browser Equipment Introduction Page

The Introduction page shows general information, such as:

- Type of equipment
- Equipment features and capabilities overview
- Hardware and software options that are available

Other links are available on the Introduction page:

- Links to the PDF files that contain technical specifications and product options
- Links to the Comtech EF Data website and customer service pages

F.4.1 Log in to the Equipment Website

You must log in before you can go to other pages in the website. The login controls your access to resources and actions in the website.

If you attempt to go to any other page in the website, the Login window requests your login.

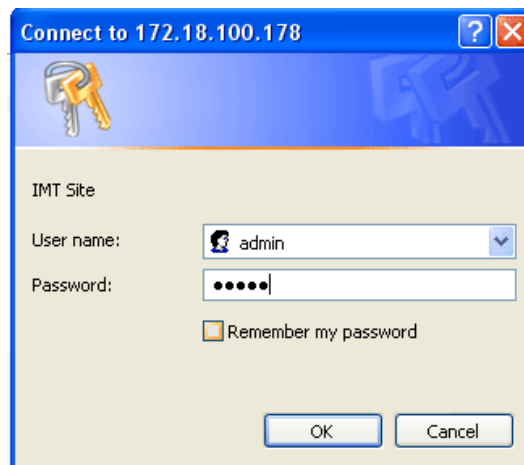

Figure F-2. Login Window

See section F.3.1 for the factory default user name and password.

Enter "admin" for the user name and "admin" for the password to gain access with full privileges to the other pages within the browser.

After a successful login, you can go to the other pages in the website.

F.5 Web Page Appearance

This page displays the Monitor and Control section of the modem web interface. The page has an appearance that resembles the DMD2050E layout.

The front panel display section of the page shows the current front panel alarm status of the modem. This display is updated immediately any time the status changes.

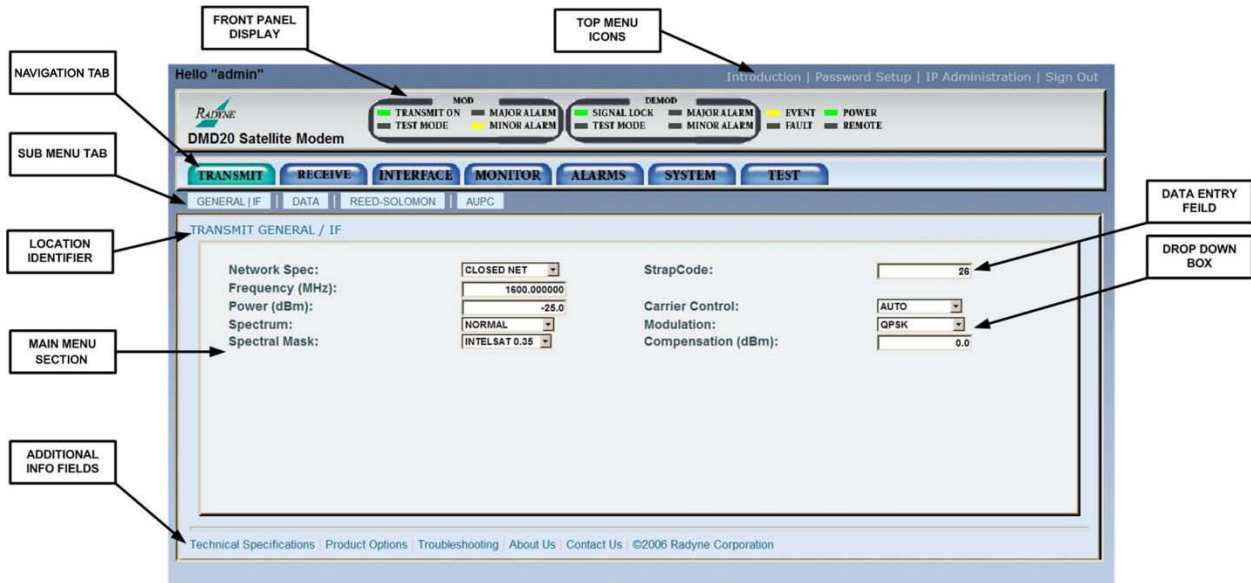

Figure F-3. Monitor and Control Web Page

The navigation tabs correspond to the front panel top-level menus. Move the cursor over a navigation tab to see the related sub-menu. The sub-menus correspond to the front panel sub-menus.



Below the navigation tabs, the main menu section shows the current programmed control state. At the top of the main menu section, location identifiers show the path to the current page.

F.6 Configure Web Browsers for the Radyne WEB Interface

F.6.1 Configure Internet Explorer 9 for the Radyne WEB Interface

Click the **Compatibility View** button on the address bar.



When **Compatibility View** is active, the color of the button is blue.

If **Compatibility View** is active, the **Monitor & Control** window should be displayed correctly.

F.6.2 Configure Firefox for the Radyne WEB Interface

On the **Monitor & Control**, **Password Setup** or **IP Administration** windows, some fields may be blank or contain **Update**.

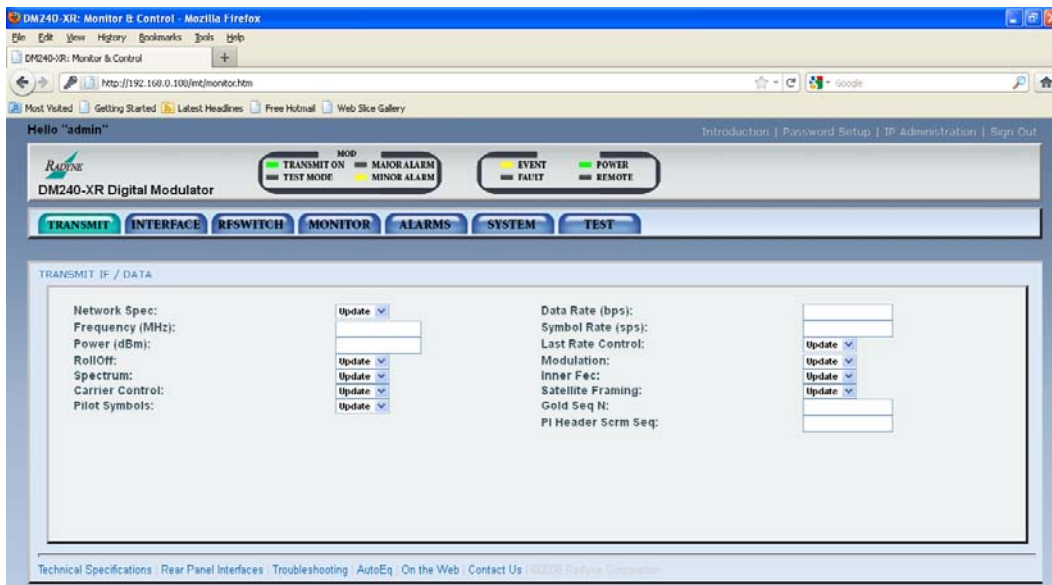

To correct the display, either 1) change the encoding, or, 2) install the Internet Explorer Tab V2 add-on.



NOTE

If you leave a window and return, it may be necessary to correct the display again.

F.6.2.1 Change the encoding:

Click **View** on the Firefox menu bar.

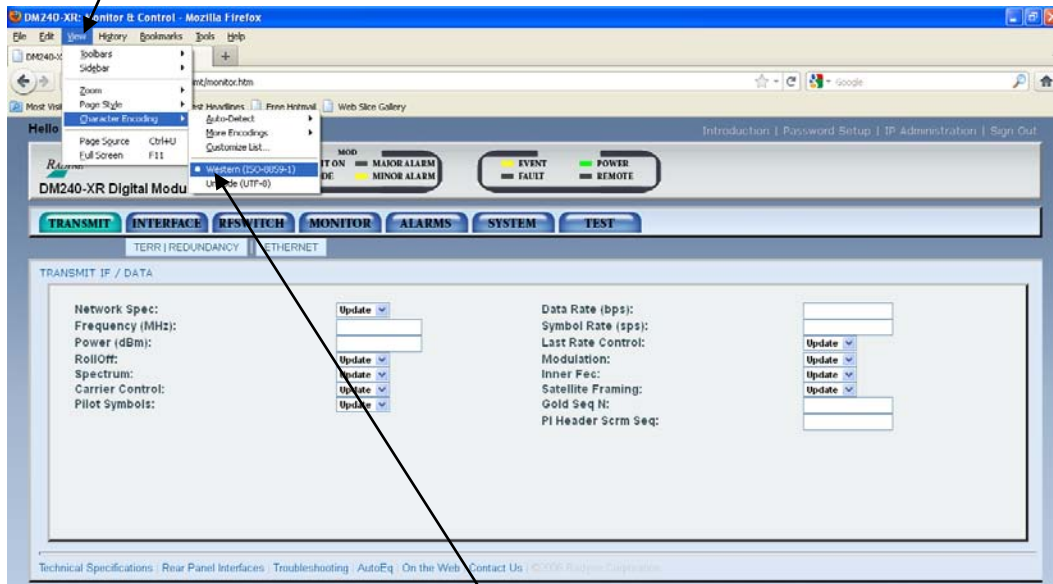

Select **Character Encoding** and click **Western (ISO-8859-1)**. The page refreshes and shows the correct values.

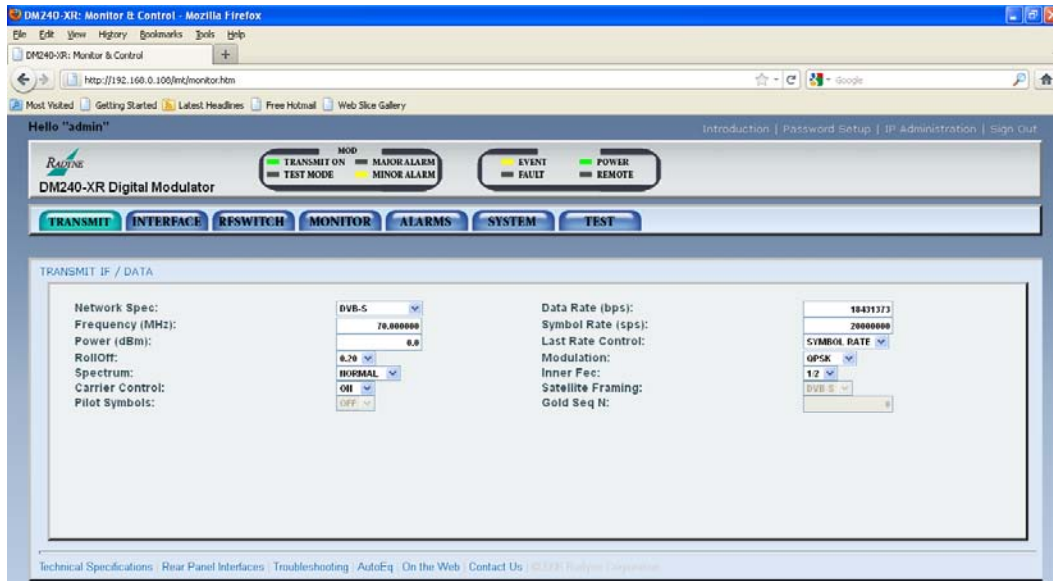

F.6.2.2 Install the Internet Explorer Tab V2 add-on

The Internet Explorer (IE) Tab V2 add-on lets you open WEB browser pages in Internet Explorer 7 mode. The link to the add-on is <https://addons.mozilla.org/en-US/firefox/addon/ie-tab-2-ff-36/>



Download and install IE Tab V2. After IE Tab V2 is installed, Firefox restarts.

Go to **Tools / IE Tab 2 Options** and add the Radyne product IP address to the **Sites Filter**.

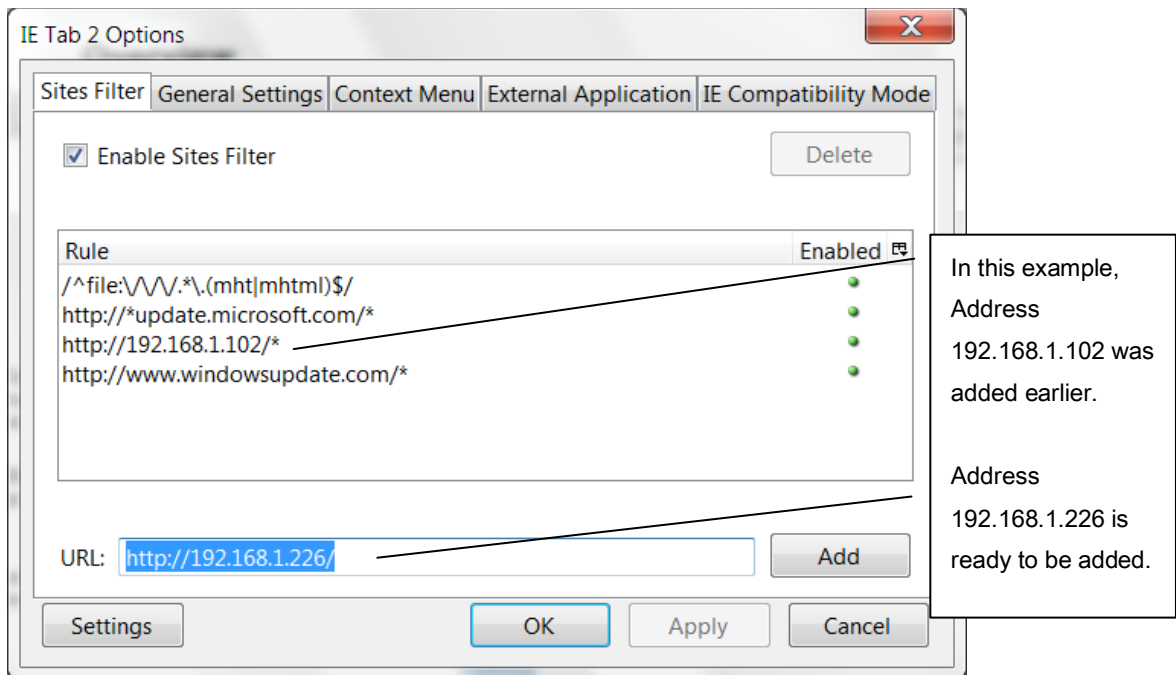

After the IP address is added to the **Sites Filter**, the WEB browser pages show correct values.

F.6.3 Configure Chrome for the Radyne WEB Browser

When you open the **Monitor & Control** window, you may see the error message “This webpage is not available”.

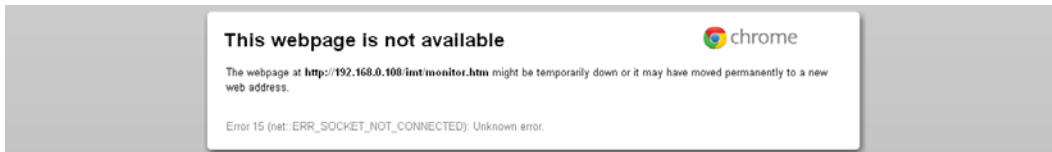

Click the Chrome address bar.



Make sure the full address is highlighted, and then press **Enter**. The **Monitor & Control** window opens.

On the **Monitor & Control**, **Password Setup** or **IP Administration** windows, some fields may be blank or contain **Update**.

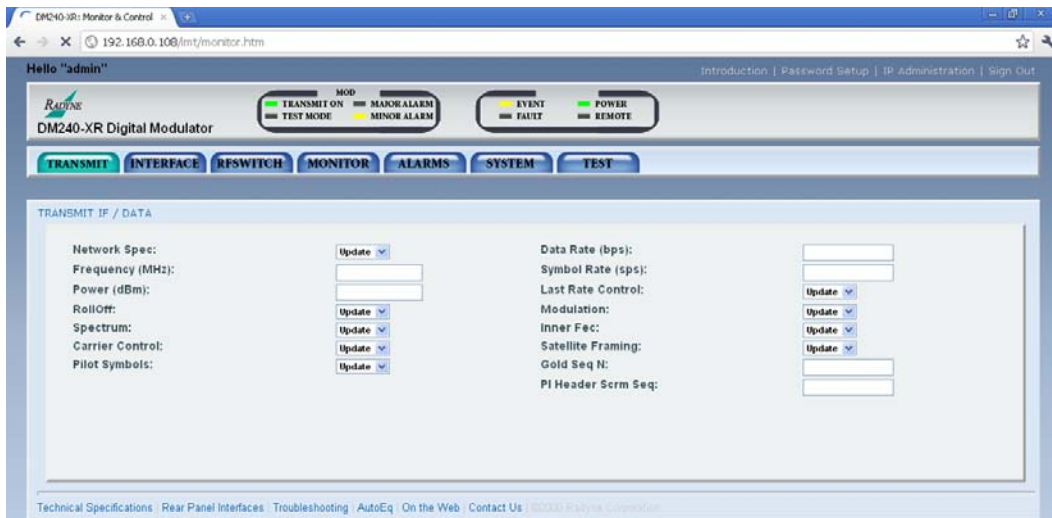

To correct the display, either 1) change the encoding, or, 2) install the Internet Explorer Tab V2 add-on.



NOTE

If you leave a window and return, it may be necessary to correct the display again.

F.6.3.1 Change the encoding

On the Chrome address bar, click the wrench icon  (Customize and Control Google Chrome).

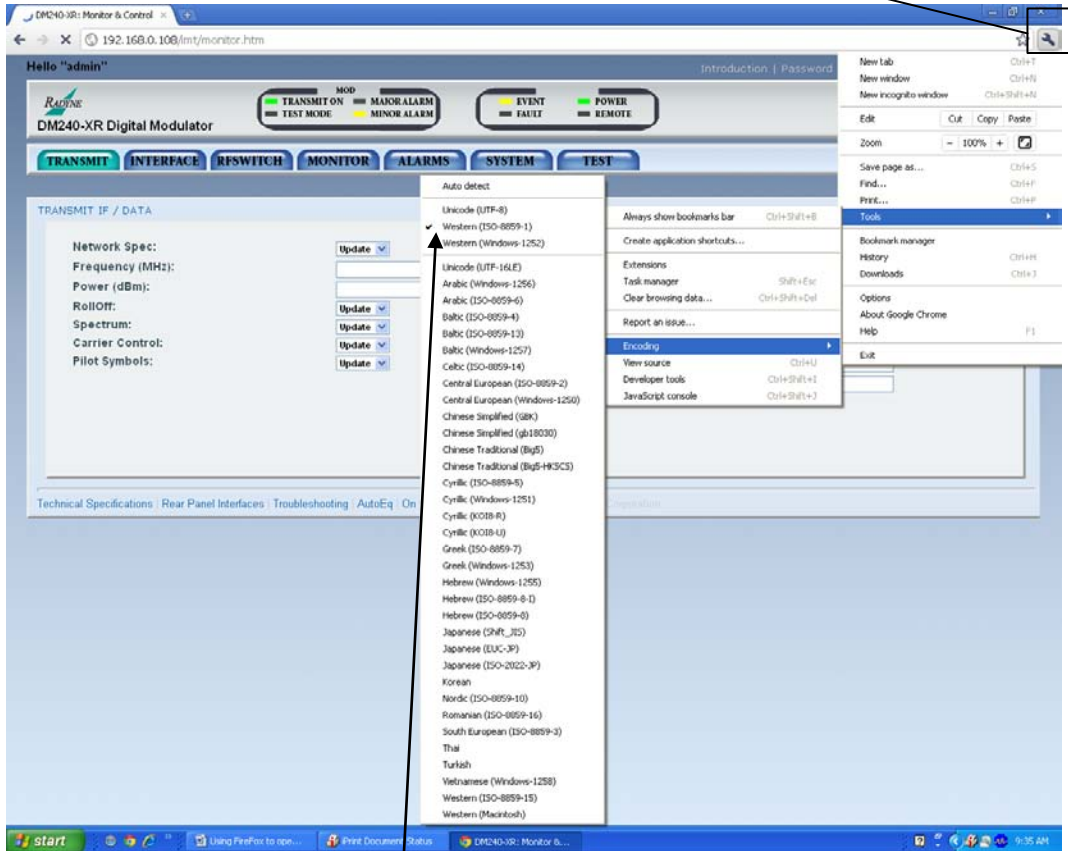

Go to **Tools / Encoding** and click **Western (ISO-8859-1)**. The page refreshes and shows the correct values.

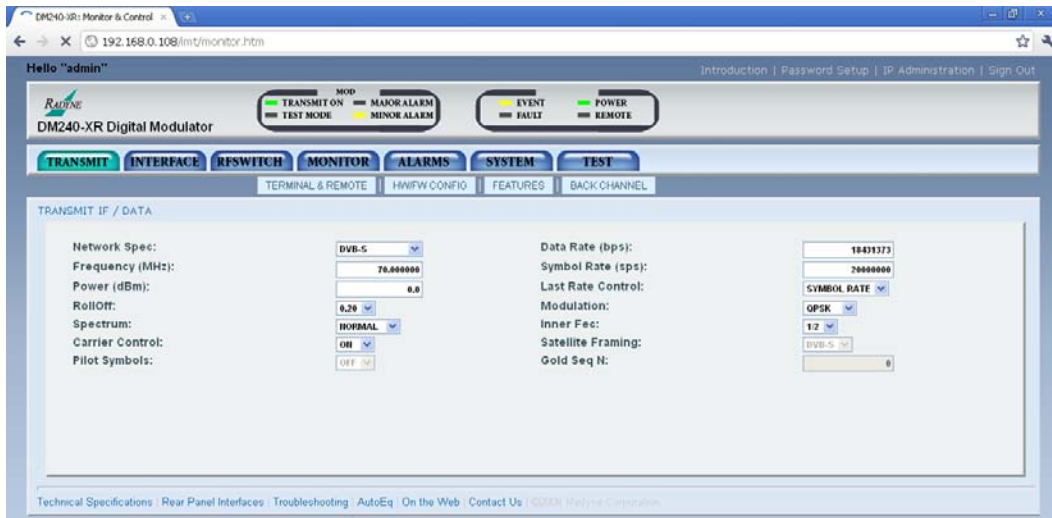

F.6.3.2 Install the Internet Explorer Tab for Chrome

The Internet Explorer (IE) Tab lets you open WEB browser pages in Internet Explorer 7 mode.

The link to install IE Tab is:

https://chrome.google.com/webstore/search/IE%20Tab?utm_source=chrome-ntp-icon



To install IE Tab, click **+ ADD TO CHROME** next to **IE Tab**.

After IE Tab is installed, the IE Tab icon  shows in the address bar.

To use IE Tab, click the icon. After IE Tab is started, the WEB browser pages show correct values.

F.6.4 Configure Safari for the Radyne WEB Browser



IMPORTANT

First, make sure to empty the browser cache.

F.6.4.1 Empty the browser cache

On the Safari menu bar, click **Edit** and then click **Empty Cache...**

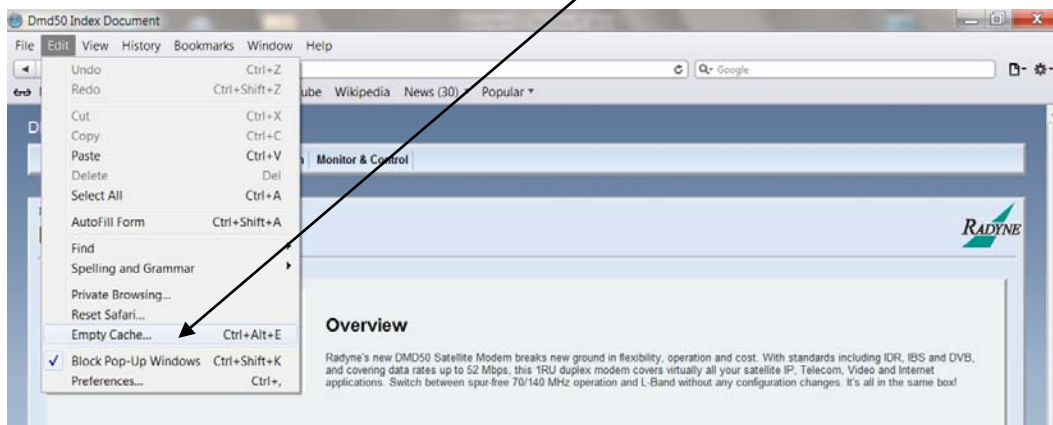

Click **[Empty]** on the confirmation popup window.

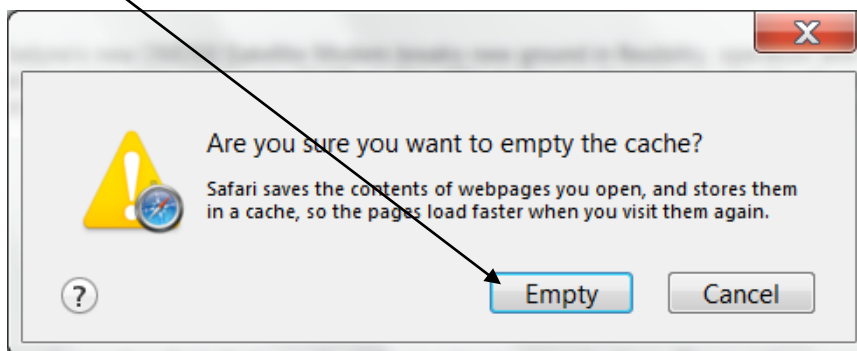

After the browser cache is empty, open the **Monitor & Control** page.



CAUTION

If you do not empty the browser cache before you open the **Monitor & Control** page, communication can be lost. If communication is lost, you must reset the Ethernet M&C port on the Radyne product.

F.6.4.2 Reset the Ethernet M&C port

To reset the Ethernet M&C port, either 1) cycle the electrical power **OFF** and **ON**, or, 2) re-enter the **Modem IP Address**. Re-entering the **Modem IP Address** avoids traffic disruption.

F.6.4.3 Re-enter the Modem IP address

1. Go to **SYSTEM / TCP/IP / MODEM IP ADDR**.
2. Press **ENTER**.
3. Type the new **IP Address** and press **ENTER**.
4. Press **ENTER** again.
5. Retype the new **IP Address** and press **ENTER**.



IMPORTANT

You must change the **IP Address**. If you just press **ENTER** repeatedly without changing the **IP Address**, the Ethernet M&C port is not reset.

On the **Monitor & Control**, **Password Setup** or **IP Administration** windows, some fields may be blank or contain **Update**.

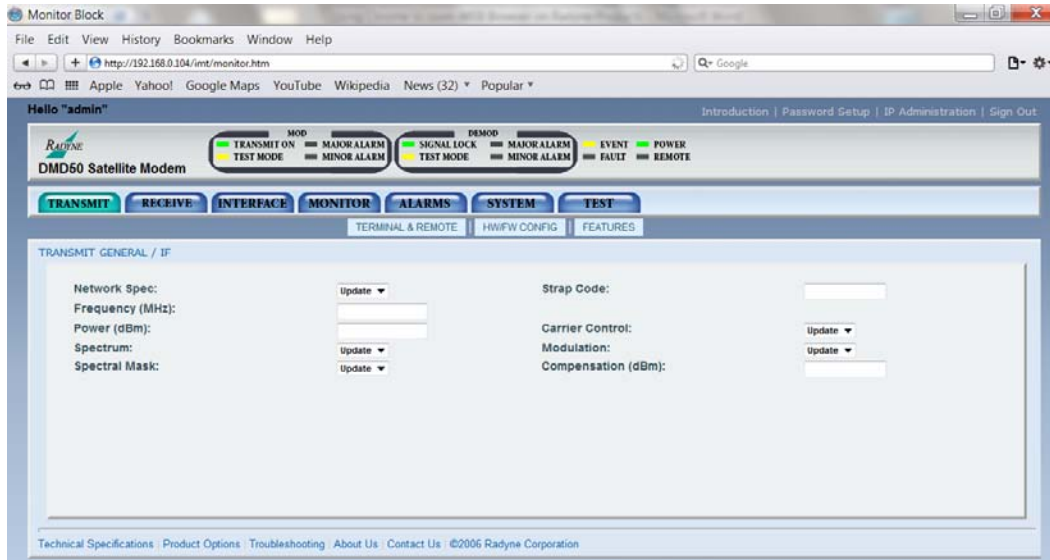

To correct the display, change the encoding.



NOTE

If you leave a window and return, it may be necessary to correct the display again.

F.6.4.4 Change the encoding

Click **View** on the Safari menu bar.

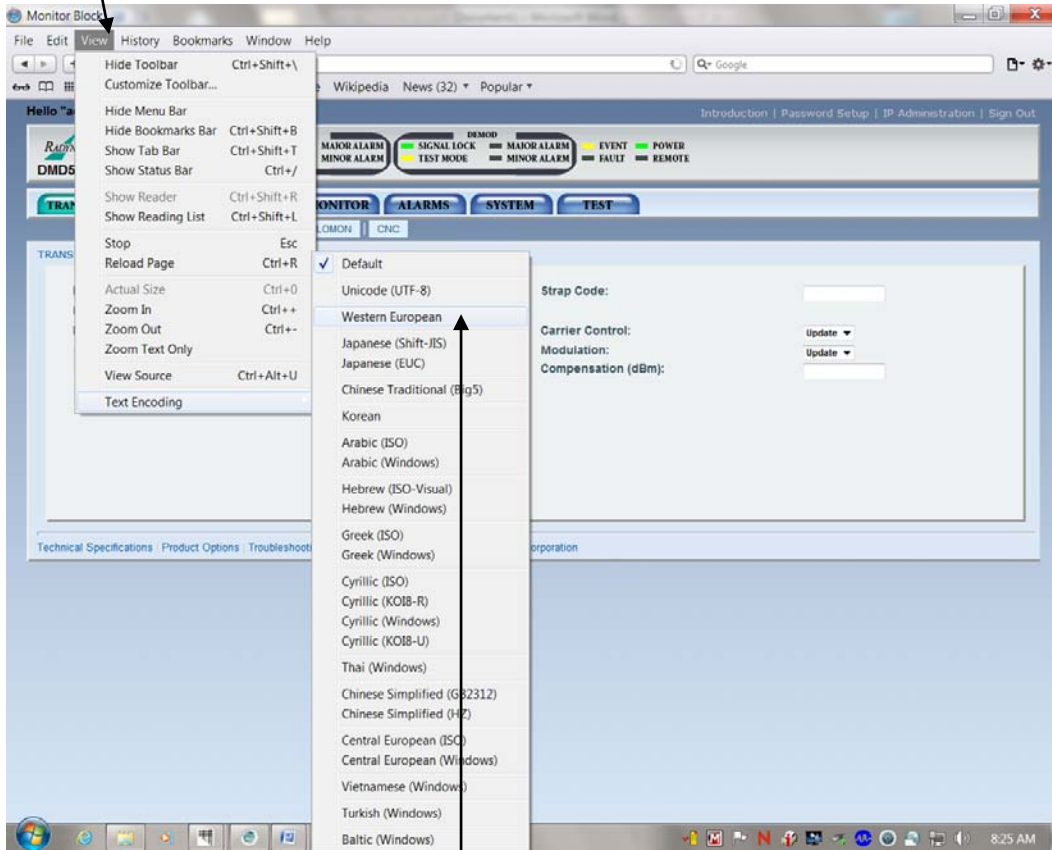

Select **Text Encoding** and click **Western European**. (The **Default** selection is not applicable.) The page refreshes and shows the correct values.

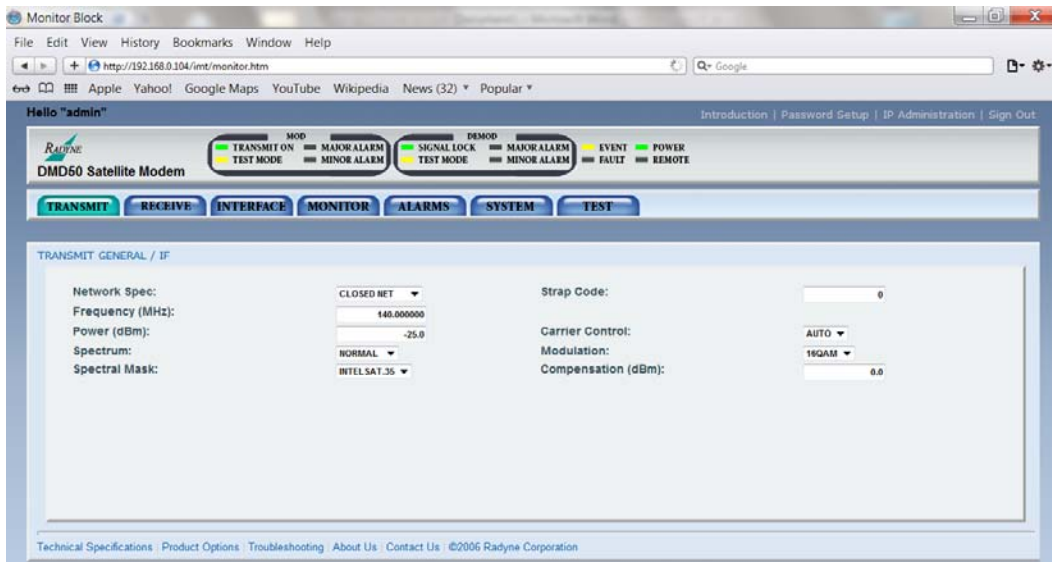

F.6.5 Configure Maxthon for the Radyne WEB Browser

On the **Monitor & Control**, **Password Setup** or **IP Administration** windows, some fields may be blank or contain **Update**.

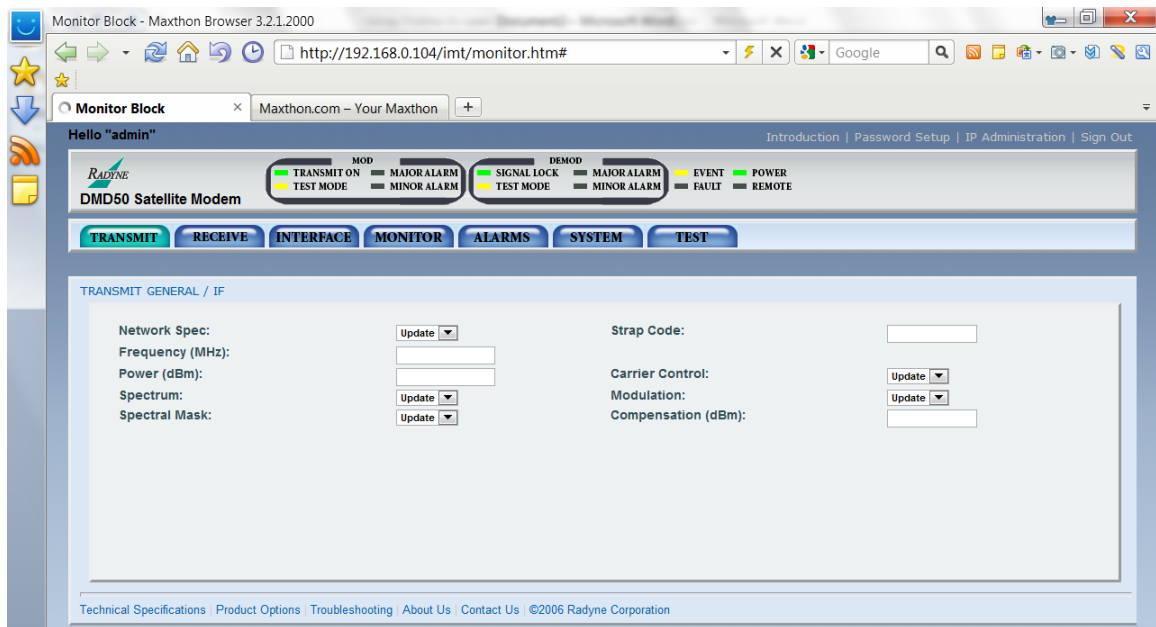

To correct the display, either 1) change the browser mode, or, 2) change the encoding.



NOTE

If you leave a window and return, it may be necessary to correct the display again.

F.6.5.1 Change the browser mode

Two browser modes are possible:

Ultra Mode  (default)

Retro Mode 

Click the browser mode icon at the right of the address bar.

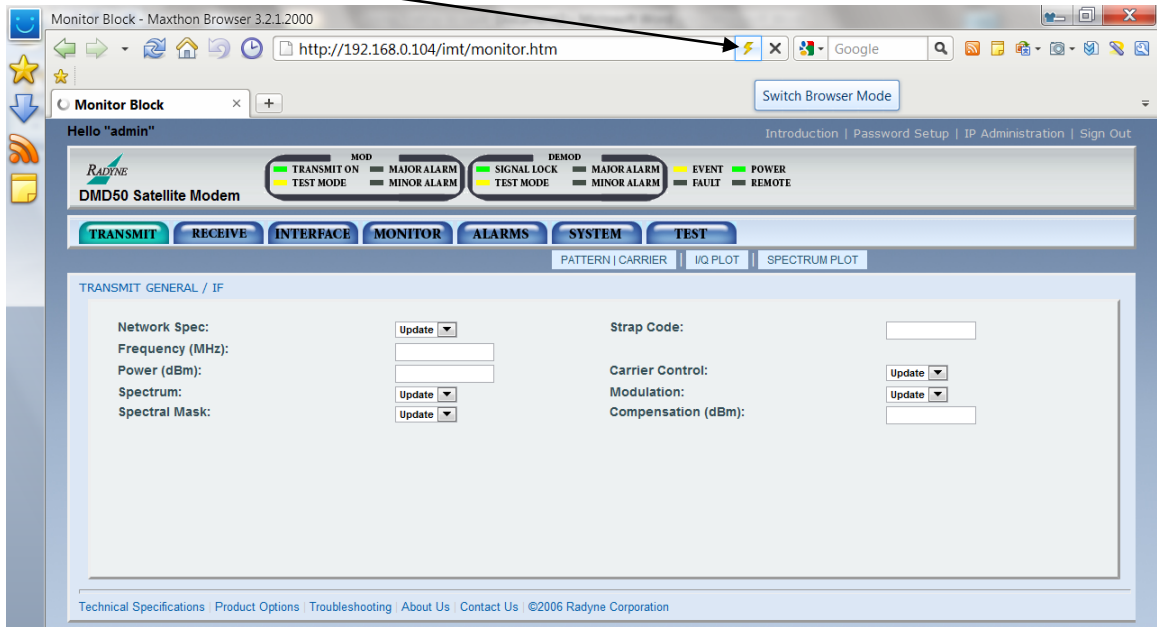

Select Retro Mode . The page refreshes and shows the correct values.

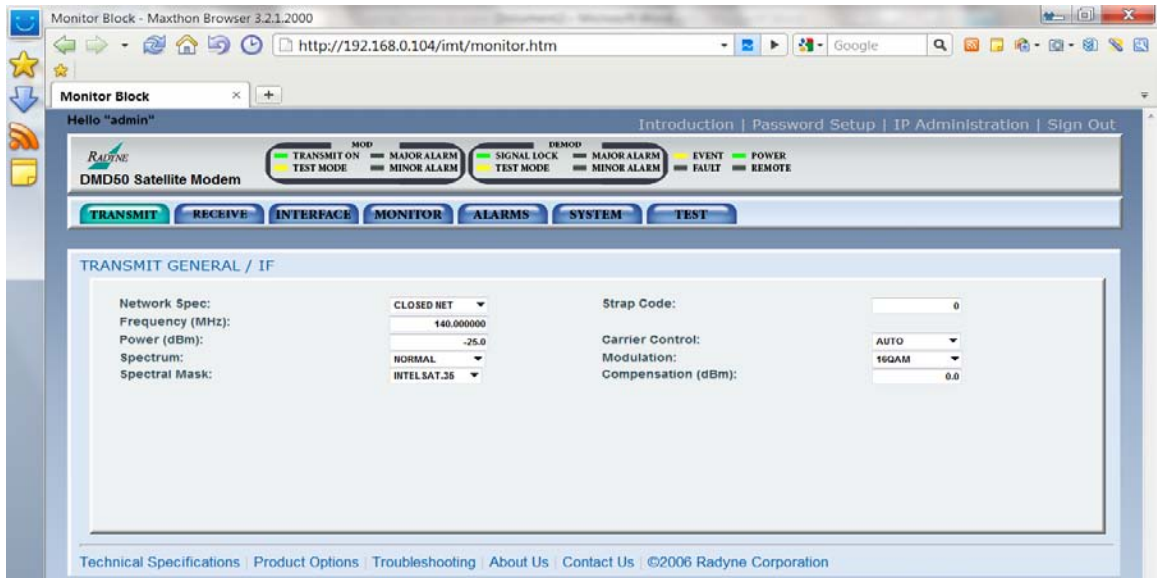

F.6.5.2 Change the encoding

On the Monitor & Control page, right click to open the browser menu.

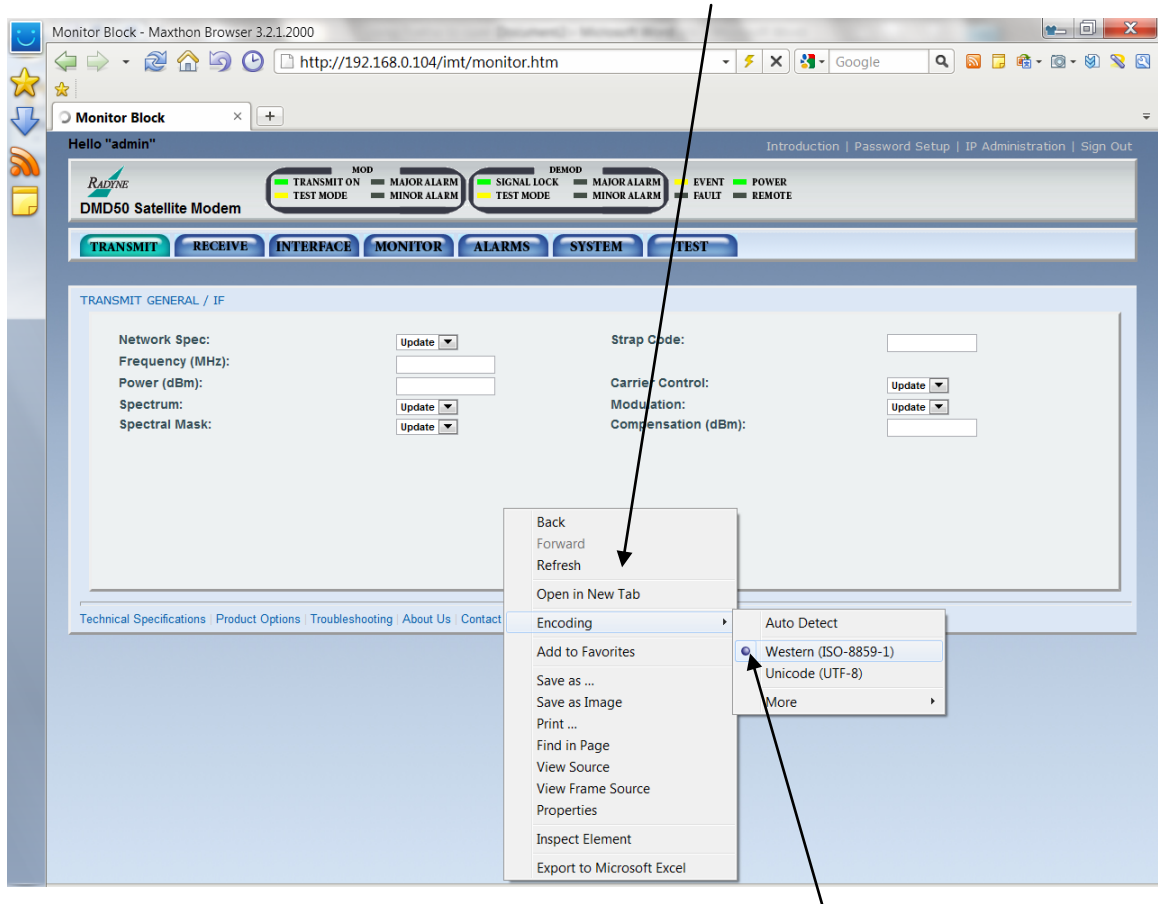

Select **Encoding**, and then click the encoding type that is already selected. The page refreshes and shows the correct values.

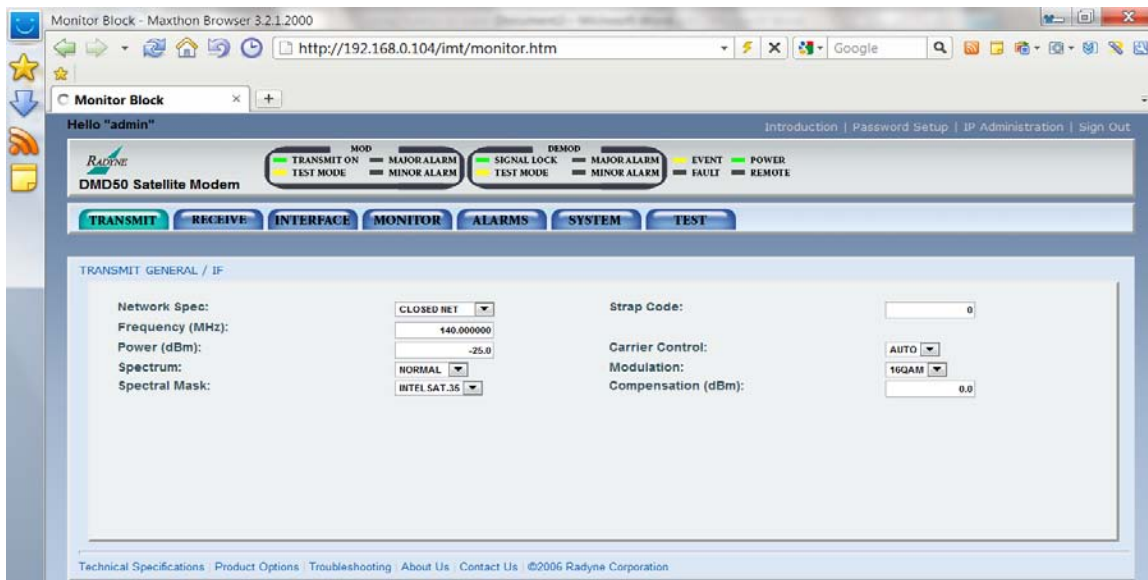

BLANK PAGE

Appendix G. AUPC Operation

G.1 Automatic Uplink Power Control (AUPC Operation)

The modem has an optional built-in provision for Automatic Uplink Power Control, AUPC. AUPC is useful when operating power levels are affected by environmental changes in the atmosphere. AUPC attempts to adjust local power output to maintain a constant E_b/N_o at the receiver location.

The modem supports three versions of AUPC. They include Radyne AUPC, EF AUPC and Near Side AUPC. Radyne AUPC and EF AUPC use satellite overhead to send messages between the local and remote ends of an SCPC link. The messaging is done with IBS 1/15 and EF AUPC Framing messages.

G.1.1 Radyne AUPC

In this case, Target E_b/N_o indicates the remote value the local unit wants to maintain by adjusting the local power level.

Radyne AUPC can be set to operate on either or both directions of a link but always require a bi-directional channel. Enabling AUPC on one side of the link will activate AUPC on the distant end of the link. It is necessary that both the Modulator and Demodulator be set to the appropriate framing for AUPC options to be editable and for the AUPC function to operate properly.

Examples of the basic Radyne AUPC Operations are described as follows:

Assume that the two modems, one at each end of the link, are set to Radyne AUPC operation. Only one direction is discussed, but the same functions could be occurring in both directions simultaneously.

Local Modem is transmitting to Remote modem under normal conditions and the Remote modem has a receive E_b/N_o of 7.5 dB. Local modem has been set to a Target E_b/N_o of 7.5 dB with an output power level of -15 dBm.

It begins raining at Remote site and the E_b/N_o drops to -7.0 then -6.8 dB. Remote Modem is constantly sending update messages of its E_b/N_o to Local modem. When Local modem sees the drop in the remote E_b/N_o , it slowly begins to raise the output power, and will continue to adjust if the remote E_b/N_o continues to drop. As the rain increases in intensity, the remote E_b/N_o decreases but Local modem continues to increase its power level to compensate.

When the rain diminishes, Local modem will see the remote E_b/N_o begin to increase. Local modem will lower its power level. The operation is therefore a feedback control loop with the added complication of a significant time delay.

G.1.2 EF AUPC

In EF AUPC mode, the Target E_b/N_o indicates the local unit wants the remote unit to maintain a power level sufficient to provide the local E_b/N_o value.

EF AUPC can be set to operate on either or both directions of a link but always require a bi-directional channel. Enabling AUPC on one side of the link will activate AUPC on the distant end of the link. It is necessary that both the Modulator and Demodulator be set to the appropriate framing for AUPC options to be editable and for the AUPC function to operate properly.

Examples of the basic EF AUPC Operations are described as follows:

Assume that the two modems, one at each end of the link, are set to AUPC operation. Only one direction is discussed, but the same functions could be occurring in both directions simultaneously.

The local modem is transmitting to modem at a remote locale under normal conditions. The remote modem has a receive E_b/N_o of 7.5 dB. The local modem has been set with a Target E_b/N_o of 7.5 dB, and has a current power output of -15 dBm.

It begins to rain at the local site, and the E_b/N_o drops to -7.0 then -6.8 dB. The local modem is constantly sending update messages of its E_b/N_o to the remote modem. When the remote modem sees the drop in the E_b/N_o , it slowly begins to raise its output power, and will continue to do so until the Target E_b/N_o is restored at the local site.

When the rain diminishes, the local modem's E_b/N_o will begin to increase. The remote modem will now lower its power level to restore the target value. The operation is therefore a feedback control loop with the added complication of a significant time delay.

G.1.3 Near Side AUPC

Near Side AUPC is a loop back system that adjusts the broadcast uplink signal when local conditions change. This is done by having the Near Side AUPC attempt to adjust the outbound power to compensate for local weather.

The local receiver must be tuned and locked to the transmitter and then the internal E_b/N_o , is used for feedback. This creates a Tx-Satellite-Rx control loop.

Near Side AUPC is primarily used for broadcast applications since the modem cannot expect to receive data from a distant location. Near Side AUPC can be utilized with any satellite framing or Network mode.

There are safeguards built into the AUPC System. First, the modulator has two parameters, which allow control of the maximum and minimum output power Levels. Second, a nominal, or default, power level is specified which takes effect if the receive signal or messaging is lost. This nominal power should be set to a level high enough to re-establish communications regardless of rain fade.

EF AUPC, also provides some control over the rate of power change; while the Radyne and Near Side AUPC use a optimized rate for rain fade compensation.

The AUPC Menu Functions and their descriptions are shown on Table G-1 and G-2.

Table G-1. Local AUPC Functions		
Function	AUPC Available Options	Description
AUPC MODE	DISABLE, NEARSIDE, RADYNE, EFDATA	Enables/Disables the AUPC to function locally
NOMINAL POWER	0 TO -25 dB	Sets default output power to be used
MINIMUM POWER	0 TO -25 dB	Sets minimum output power to be used
MAXIMIM POWER	0 TO -25 dB	Sets maximum output power to be
TARGET Eb/No	4.0 TO 16 dB	Desired E_b/N_0 of remote modem
TRACKING RATE	6.0 to 0.5 dB/MIN	Adjustable in .5dB increments
LOCAL CL ACTION	HOLD, MAXIMUM, NOMINAL	Allows user to determine what power setting the remote modem will use in the event of a carrier loss at the local side.
REMOTE CL ACTION	HOLD, MAXIMUM, NOMINAL	This setting allows users to determine what local output power setting to use in the event that the remote end has a carrier loss.
<p>1. The AUPC Menus are located under the Modulator Menu as shown in Section 4. 2. The EF AUPC Menu displays when EFAUPC Framing is enabled in the Demod and Mod set up menus. 3. Highlighted areas are activated when modem is set to EF AUPC</p>		

Table G-2. Remote AUPC Functions (EF AUPC Only)		
Function	AUPC Available Options	Description
AUPC MODE	Disable, EFDATA	Enables/Disables the AUPC to function remotely
LOOPBACK	Enabled/Disabled	Loop back test over satellite link
TX 2047 TEST BER	Enabled/Disabled	Initiates 2047 Test pattern BER Test
RX 2047 BER	Status Menu	Identifies the BER status on the distant RX side
AUPC DEF LVL		Sets default output power to be used
<i>The Remote AUPC Menus are only supported by EFAUPC</i>		

BLANK PAGE

Appendix H. Drop and Insert (D&I)

H.1 Drop and Insert (D&I)

The Drop and Insert (D&I) function provides an interface between a full T1 or E1 Trunk whose framing is specified in CCITT G.704 and a fractional Nx64 Kbps Satellite Channel. The Drop and Insert functionality conforms to IBS, small IDR, and Radyne Proprietary Efficient D&I Framing Structures. For information pertaining to Radyne proprietary Efficient Drop and Insert function, refer to Appendix I.

The Drop function allows the user to select the terrestrial T1 or E1 timeslots that are to be dropped off for transmission over the link in the specified satellite channels. The Insert function allows the user to select the T1 or E1 timeslots into which the received satellite channels are to be inserted. The two functions are completely independent allowing maximum flexibility in choosing configurations. The four-port G.703 Interface allows one or more modems to be looped together using the same T1 or E1 trunk.

The Transmit Data Trunk is brought into the modem via the Send Data In (SDI) Port. From there, the TX Baseband Processor extracts the selected timeslots from the G.704 Frame and prepares them for transmission. The original trunk data is sent out of the modem unaltered via the Send Data Out (SDO) Port. The Receive Data Trunk is brought into the modem via the Insert Data In (IDI) Port. The data is buffered inside the modem and the RX Baseband Processor inserts satellite data into the selected timeslots in the G.704 Frame. The modified terrestrial trunk is then output via the Receive Data Out (RDO) Port.

Figure H-1 shows two modems looped together. This configuration could be simplified to just use one modem, or extended to use more than two modems. Figure H-2 shows an alternative method of looping where all of the drop (transmit) data is processed prior to performing any insert (receive) processing. In both configurations, the terrestrial trunk is providing the timing for the satellite transmission and for the terrestrial receive.

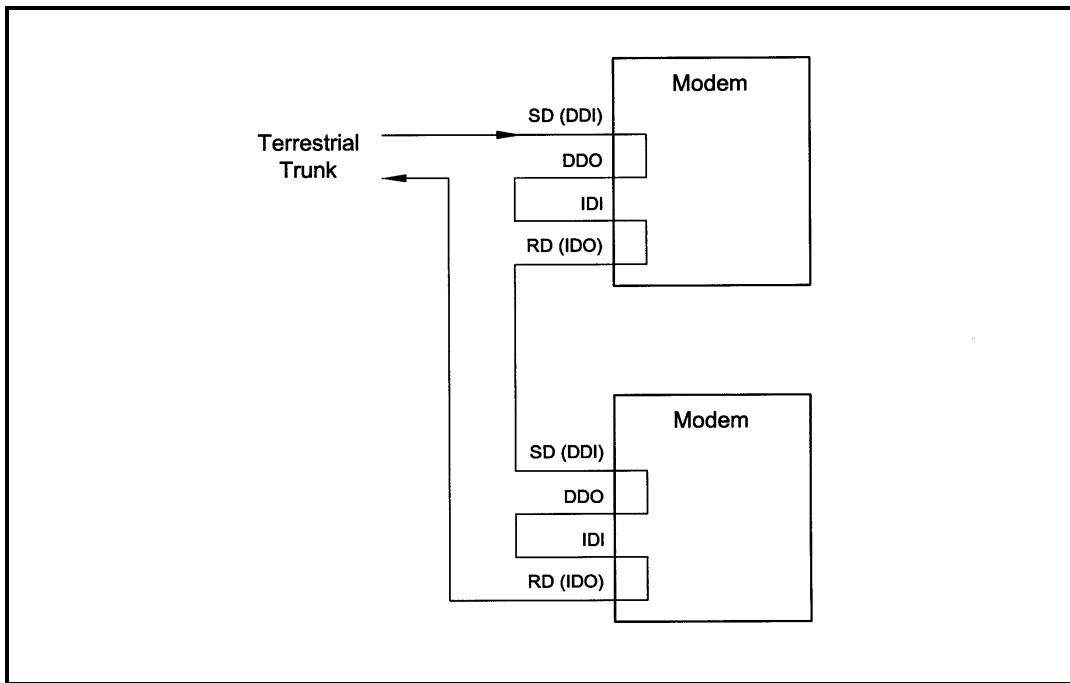

Figure H-1 Looped Modems

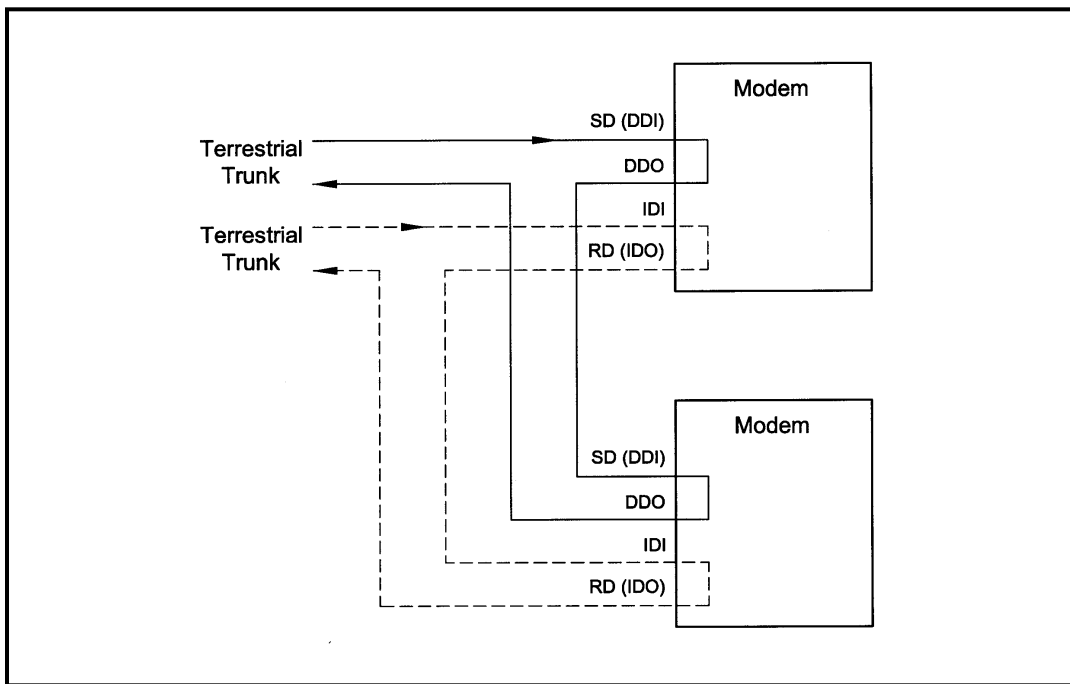

Figure H-2 Looped Modems with Separate D&I Trunks

H.1.1 Drop Only

When Drop is enabled and Insert is disabled, the unit performs a drop-only function. Framed E1 or T1 Data is input via the Send Data In Port, the selected timeslots are dropped into the IBS frame structure, and the unaltered terrestrial data is output via the Send Data Out Port (refer to Figure H-3).

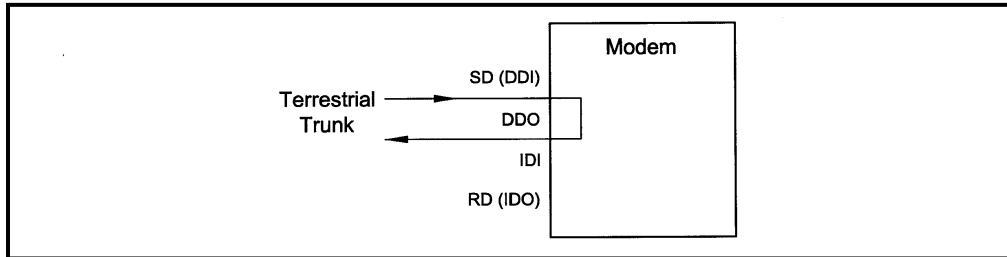

Figure H-3 Drop Only

H.1.2 Insert Only

When Insert is enabled and Drop is disabled, the unit performs an insert-only function. If framed terrestrial E1 or T1 Data is available, it should be input via the Insert Data In Port. The Terrestrial Data is buffered inside the Modem. The RX Baseband Processor inserts satellite data into the selected timeslots in the G.704 Frame and the modified terrestrial data is then output via the Receive Data Out Port (refer to Figure H-4).

If framed terrestrial data is not available, selection of the Internal T1/E1 frame source will cause the modem to generate the required G.704 Frame. The Satellite Data will be inserted into the selected timeslots, and the resulting terrestrial data will be output via the Receive Data Out Port. Any non-inserted timeslots in the G.704 Frame will be filled with the appropriate Idle Code (refer to Figure H-5).

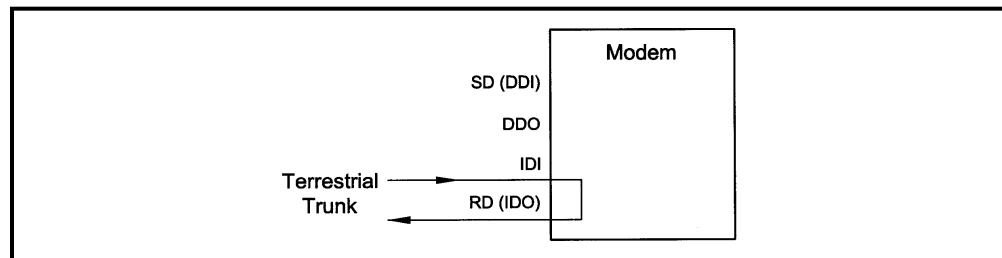

Figure H-4 Insert Only with External Frame Source

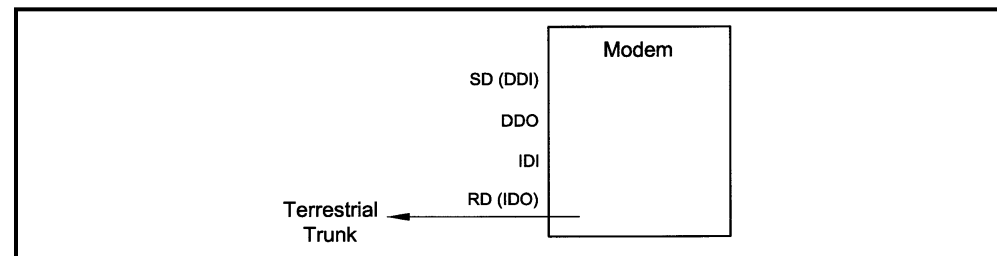

Figure H-5 Insert Only with Internal Frame Source

H.1.3 Mode Selection

D&I can be easily configured to support several commonly used terrestrial data formats. For E1 Data, the user can choose between PCM-30, PCM-30C, PCM-31 and PCM-31C. For T1 Data, the user can choose between T1-D4, T1-ESF, and SLC-96. The following paragraphs provide more information on the various mode selection capabilities.

H.1.3.1 PCM-30

The PCM-30 Mode of Operation supports an E1 Interface with Multiframe Alignment (MFAS) and Channel Associated Signaling (CAS). The user may independently program n timeslots to drop and n timeslots to insert where $n = 1, 2, 3, 4, 5, 6, 8, 10, 12, 15, 16, 20, 24, \text{ or } 30$. In addition to the selected drop timeslots, the Transmit Function also extracts the appropriate ABCD signaling bits from terrestrial timeslot 16 for transmission in IBS Frame as required. Conversely, the Receive Function extracts received ABCD signaling bits from the IBS Frame and inserts them in timeslot 16 of the appropriate terrestrial frame. This transmission and reception of ABCD signaling based upon the drop and insert timeslots is performed automatically and is transparent to the user. In PCM-30 mode, the user may *not* select timeslot 16 as a Drop or Insert Timeslot.

H.1.3.2 PCM-30C

The PCM-30C Mode of Operation supports an E1 Interface with Multiframe Alignment (MFAS) and Channel Associated Signaling (CAS). In addition, the Drop function verifies the received terrestrial CRC checksum and the Insert function calculates the required CRC checksum. The user may independently program n timeslots to drop and n timeslots to insert where $n = 1, 2, 3, 4, 5, 6, 8, 10, 12, 15, 16, 20, 24, \text{ or } 30$. In addition to the selected Drop timeslots, the Transmit Function also extracts the appropriate ABCD signaling bits from terrestrial timeslot 16 for transmission in IBS Frame as required. Conversely, the Receive Function extracts received ABCD signaling bits from the IBS frame and inserts them in timeslot 16 of the appropriate terrestrial frame. This transmission and reception of ABCD signaling based upon the Drop and Insert timeslots is performed automatically and is transparent to the user. *In PCM-30C Mode, the user may not select timeslot 16 as a Drop or Insert Timeslot.*

H.1.3.3 PCM-31

The PCM-31 Mode of Operation supports an E1 Interface with no Multiframe Alignment (MFAS) or Channel Associated Signaling (CAS). The user may independently program n timeslots to drop and n timeslots to insert where $n = 1, 2, 3, 4, 5, 6, 8, 10, 12, 15, 16, 20, 24, \text{ or } 30$. Because there is no implied ABCD signaling, the user is free to select timeslot 16 as a Drop or Insert Timeslot.

H.1.3.4 PCM-31C

The PCM-31C Mode of Operation supports an E1 Interface with no Multiframe Alignment (MFAS) or Channel Associated Signaling (CAS). In addition, the Drop Function verifies the received terrestrial CRC checksum and the Insert Function calculates the required CRC checksum. The user may independently program ' n ' timeslots to drop and ' n ' timeslots to insert where ' n ' = 1, 2, 3, 4, 5, 6, 8, 10, 12, 15, 16, 20, 24, or 30. Because there is no implied ABCD signaling, the user is free to select timeslot 16 as a Drop or Insert Timeslot.

H.1.3.5 T1-D4/T1-D4-S

The T1-D4 Mode of Operation supports a T1 Interface with 12 frames per multiframe. The user may independently program n timeslots to drop and n timeslots to insert where n = 1, 2, 3, 4, 5, 6, 8, 10, 12, 15, 16, 20, 24, or 30. Robbed Bit Signaling (RBS) is handled without any need for operator intervention and is transparent to the user.

H.1.3.6 T1-ESF/T1-ESF-S

The T1-ESF Mode of Operation supports a T1 Interface with 24 frames per multiframe. The CRC-6 checksum is automatically checked by the Drop Function and generated by the Insert Function and placed in the appropriate F-bit positions in the terrestrial multiframe. The user may independently program n timeslots to drop, and n timeslots to insert, where n = 1, 2, 3, 4, 5, 6, 8, 10, 12, 15, 16, 20, 24, or 30. Robbed Bit Signaling (RBS) is handled without any need for operator intervention and is transparent to the user.

H.1.4 Multidestinational Systems

Because the Drop and Insert Functions are completely independent, so multi-destinational communications are easily supported.. Figure H-6 illustrates a Multi-destinational System with one Hub site and three remote sites. At the Hub site, thirty channels are being transmitted to all three remote sites and a fractional set of channels is being received from each remote site. At the other end of the link, each remote site is transmitting a fractional E1 to the Hub site as well as receiving all 30 channels from the Hub site. It also identifies those channels intended for it, and inserts them into the terrestrial data stream.

H.1.5 Drop and Insert Mapping

The following displays under Interface D&I Setup (both Tx and Rx), are editing displays only:

SATCh TS
Enter to Edit

Any changes made in these displays are made on the screen, but *are not* entered into the modem. Once these menus are configured, the Mapping Menu must be used to actually enter the settings into the modem.

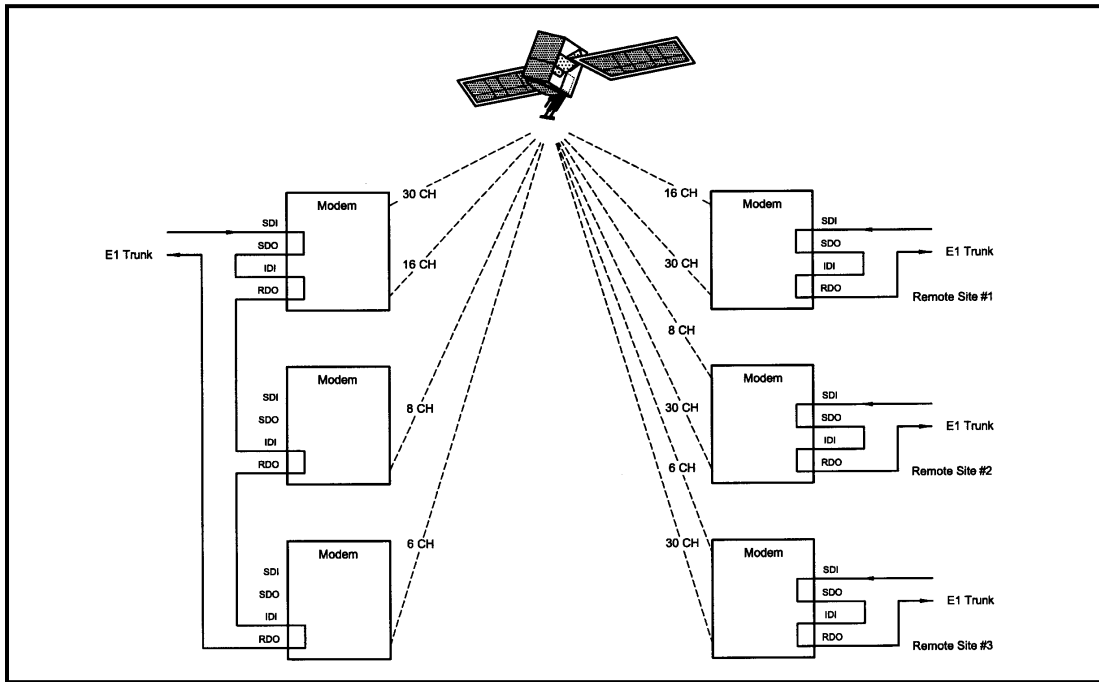

Figure H-6 Multidestinational Communications

Example :

For a modem w/ Drop & Insert enabled at a data rate of 256 (with timeslots assigned 1 - 1, 2 - 2, etc.). At a data rate of 256, the modem will allow 4 channels to assign timeslots. Under the Tx Menu, assign the timeslots that are to be used to the 4 channels. CH1 is assigned to TS1 (Timeslot #1), CH2 to TS 2, CH3 to TS3 and CH4 to TS4, <ENTER> must be depressed after assigning each individual TS. Once the timeslots are assigned to the channels, use the Left or Right Arrow Key to scroll to the Mapping Menu. This menu will appear in the following way:

```

Map      Copy
*****  *****

```

This is the menu where the channel assignments are actually entered into the modem. To do this, perform the following steps:

For the Transmit Side:

1. Push <ENTER> to get the flashing cursor.
2. Use the Up Arrow Key to make the left portion of the display read "TX EDIT".
3. Use the Right or Left Arrow Keys to switch the flashing cursor to the right portion of the display.

4. Use the Up or Down Arrow Key to until the right hand portion displays "TX ACTIVE".
5. The mapping display should now look like this:

```

      Map      Copy
TX EDIT > TX ACTIVE

```

6. Push <ENTER> to enter this command. This tells the modem to configure to the settings that were assigned in the Channel/Timeslot display.

For the Receive Side:

1. With Rx Side Channels configured as follows: CH1 to TS1, CH2 to TS2, CH3 to TS3, and CH4 to TS4.
2. After the timeslots are assigned properly, scroll to the Mapping Menu and use the above procedure to enter the settings into the modem.
3. Set the display to read:

```

      Map      Copy
RX EDIT > RX ACTIVE

```

4. Press <ENTER> to enter the settings into the modem.

To View the current Timeslot Assignment:

1. If there is a question of the channels not being entered properly, the Mapping Menu may be used to see how the channels/timeslots are configured in the modem.
2. Use <ENTER> and the Arrow Keys to make the mapping menu read (for the Tx Side):

```

      Map      Copy
TX ACTIVE > TX EDIT

```

3. Press <ENTER>. The modem has now copied the current Tx Settings to the Tx Channel/Timeslot Display.
4. For the Rx Side:

```

      Map      Copy
RX ACTIVE > RX EDIT

```

5. Press <ENTER>. The modem has now copied the current Rx Settings to the Rx Channel/Timeslot display).



It is not mandatory to assign timeslots in sequential order, although the lowest timeslot must be entered in the lowest channel. For example: timeslots may be assigned 1 - 2, 2 - 5, etc. but not 1 - 5, 2 - 2.

H.2 Configuring the Modem for Drop and Insert

Several dependencies exist when configuring the modem for Drop and Insert (D&I). The following paragraphs explain these dependencies and provide the user with the information required to ensure smooth transition into D&I and to minimize the potential impact of these dependencies.

H.2.1 Data Rate

Data Rate affects the Drop and Insert function in the following ways:

- It determines the number of Satellite Channels that will be displayed in the Edit Maps.
- It contributes to the Operational Mode selection process. Trying to change the Operational Mode to D&I when a data rate is not set to a valid D&I rate will result in the error message 'INVALID DATA RATE,' and the mode change will not be allowed.
- It contributes to the Terrestrial Framing Mode selection process. Trying to select a T1-type Drop Mode such as T1-ESF with the mod data rate set to 1920000 bps (a valid E1 D&I rate but not a valid T1 rate) will result in the error message 'INVALID DROP MODE' and the selection will not be allowed. Trying to select a T1 type Insert Mode such as T1-D4 with the demod data rate set to 1920000 bps will result in the error message INVALID INSERT MODE and the selection will not be allowed.
- Once D&I Mode has been selected, trying to change the data rate to something other than another valid D&I data rate will result in the error message 'RATE OUT OF BOUNDS' and the change will not be allowed.
- Once D&I Mode has been selected with a T1 Terrestrial Framing Mode, attempting to change the data rate to 1920000 will result in the error message 'RATE OUT OF BOUNDS' and the change will not be allowed.

Therefore, the data rate should be entered as the first step in configuring the modem for D&I. The Mod Data Rate should be set according to the number of timeslots to be dropped and the Demod Data Rate should be set according to the number of timeslots to be inserted. The following table gives the allowable D&I data rates based on the number of slots (n) to be dropped or inserted.

n = 1, data rate = 64000
n = 2, data rate = 128000
n = 3, data rate = 192000
n = 4, data rate = 256000
n = 5, data rate = 320000
n = 6, data rate = 384000
n = 8, data rate = 512000
n = 10, data rate = 640000
n = 12, data rate = 768000
n = 15, data rate = 960000
n = 16, data rate = 1024000
n = 20, data rate = 1280000
n = 24, data rate = 1536000
n = 30, data rate = 1920000 (valid with E1 Interface only)

H.2.2 Operational Network Specification

The Network Specification of the Modem often determines which additional menus and displays are available for use. The D&I Mode-specific menus are not displayed unless the Network Specification of the modem is set to D&I. Therefore, the second step in configuring the modem should be to set the Network Specification to D&I. At this point, the D&I specific menus in the Interface section become available and remain available until the Network Specification of the modem is changed to something other than D&I. When the Network Specification is changed to something other than D&I, the D&I specific menus automatically disappear.

H.2.3 Terrestrial Framing - Drop Mode/Insert Mode

The Drop Mode Selection and the Insert Mode Selection identify the Terrestrial Data-Framing Format. As previously mentioned, their selection is influenced by the Modulator and Demodulator Data Rates, and trying to select a T1 Type Framing Format with a data rate of 1920000 bps will result in an error message. In turn, the selection of the terrestrial framing formats influences the satellite channel to terrestrial timeslot mappings in the following manner:

- The selection of T1-D4, T1-ESF, or SLC-96 type terrestrial framing format limits the terrestrial timeslots to values from 1 - 24.
- The selection of PCM-30 or PCM-30C type terrestrial framing limits the terrestrial timeslots to values from 1 - 15, 17 - 31. In these modes, terrestrial timeslot 16 is reserved for ABCD signaling and may not be dropped or inserted.
- The selection of PCM-31 or PCM-31C type terrestrial framing limits the terrestrial timeslots to values from 1 - 31. Therefore, the terrestrial framing format should be identified via the Drop Mode and Insert Mode entries prior to editing the Drop or Insert satellite channel to terrestrial timeslot maps.

H.2.3.1 Insert Terrestrial Frame Source

The Insert Terrestrial Frame Source selection tells the Modem from where the Insert Terrestrial Frame is coming.

External: Indicates that the terrestrial frame is to be input via the Insert Data In Port.

Internal: Indicates that the modem needs to generate the terrestrial frame and that all non-inserted timeslots need to be filled with the appropriate idle code based upon the terrestrial framing (T1 or E1).

The selection of the Insert Terrestrial Frame Source also influences the Buffer Clock selection in the following manner:

When the Insert Terrestrial Frame Source selection is set to External, the received satellite data will be clocked out of the Doppler Buffer based upon the clock recovered from the insert data input. Therefore, the Buffer Clock selection will automatically be set to External and cannot be modified. Attempts to select a different buffer clock will result in the error message INVALID BUFFER CLOCK and the selection will not be allowed.

When the Insert Terrestrial Frame Source selection is set to Internal, the operator needs to specify how data should be clocked out of the Doppler Buffer. In this case, the operator will be able to select SCTE, SCT, RX SAT, or EXT EXC as the source for the Buffer Clock. Therefore, the Insert Terrestrial Frame Source selection should be made prior to attempting to change the Buffer Clock. In most instances, the Insert Terrestrial Frame Source selection will be set to External and the Buffer Clock will automatically be set to External.

H.2.4 D&I Sample Configurations and D&I Clock Setup Options

The following are several examples of how to configure the modem for D&I. Also, refer to Figures 3-14 through 3-17 for the D&I Clocking Setup Options Available.

Example 1: Drop 512 Kbps from a T1 trunk, 3/4 Rate Viterbi
 Insert 512 Kbps into a T1 trunk, 3/4 Rate Viterbi
 Drop 512 Kbps from a T1 trunk, 3/4 Rate Viterbi

Under Interface:

Under TX Setup:

Set Tx Type according to your hardware configuration (example: G703BT1B8ZS)

Set Tx Clock = SCTE

Under Tx D&I:

Set Drop Mode = T1-D4

Use SATCh TS edit capability to define desired mapping of

Satellite Channels to drop Terrestrial Slots

Use Map Copy to copy Tx Edit to Tx Active

Under Modulator:

Under Mod Data:

Set Data Rate = 512000

Set Conv Enc = 3/4 Rate VIT

Under Modulator:

Set Network Spec. = Drop & Insert

Under Interface:

Under TX Setup:

Set Tx Type according to your hardware configuration (example: G703BT1B8ZS)

Set Tx Clock = SCTE

Under Tx D&I:

Set Drop Mode = T1-D4

Use SATCh TS edit capability to define desired mapping of

Satellite Channels to drop Terrestrial Slots

Use Map Copy to copy Tx Edit to Tx Active

Under Modulator:

Under Mod IF:

Set Frequency to desired value

Turn IF Output Power On

Under Demodulator:

Under Demod Data:

Set Data Rate = 512000

Set Conv Enc = 3/4 Rate VIT

Under Interface:

Under RX Setup:

Set Rx Type according to your hardware configuration

Set Buff Size to desired depth

Under Rx D&I:

Set Insert Mode = T1-D4

Set T1 E1 Frm Src = External

Use SATCh TS edit capability to define proper mapping of

Satellite Channels to insert Terrestrial Slots

Use Map Copy to copy Rx Edit to Rx Active

Under Demodulator:

Under Demod IF:

Set Frequency to desired value

Under Demodulator:
Set Network Spec. = Drop & Insert

Example 2: Multidestinational Remote Site Programming
Drop 512 Kbps from a T1 trunk, 3/4 Rate Viterbi.
Extract 512 Kbps from a 1536 Kbps carrier and insert into a
T1 trunk, 3/4 Rate Viterbi.

Drop 512 Kbps from a T1 trunk, 3/4 Rate Viterbi
Configuration setup is exactly as previously shown in Example 1.

Extract 512 Kbps from a 1536 Kbps carrier and insert into a T1 trunk, 3/4 Rate Viterbi

Under Interface:
Under RX Setup:
Set Rx Type according to your hardware configuration
Set Buff Size to desired depth
Under Rx D&I:
Set Insert Mode = T1-D4
Set T1 E1 Frm Src = External
Use SATCh TS edit capability to define proper mapping of Satellite Channels to
insert Terrestrial Slots
For Satellite Channels that are not to be inserted, enter "NI" (No Insert) for the
Terrestrial Slot
Use Map Copy to copy Rx Edit to Rx Active

Under Demodulator:
Under Demod Data:
Set Data Rate = 1536000
Set Conv Enc = 3/4 Rate VIT

Under Demodulator:
Set Network Spec. = Drop & Insert

Under Demodulator:
Under Demod IF:
Set Frequency to desired value.

Figures H-7 through H-10 illustrate D&I Clock Setup Options

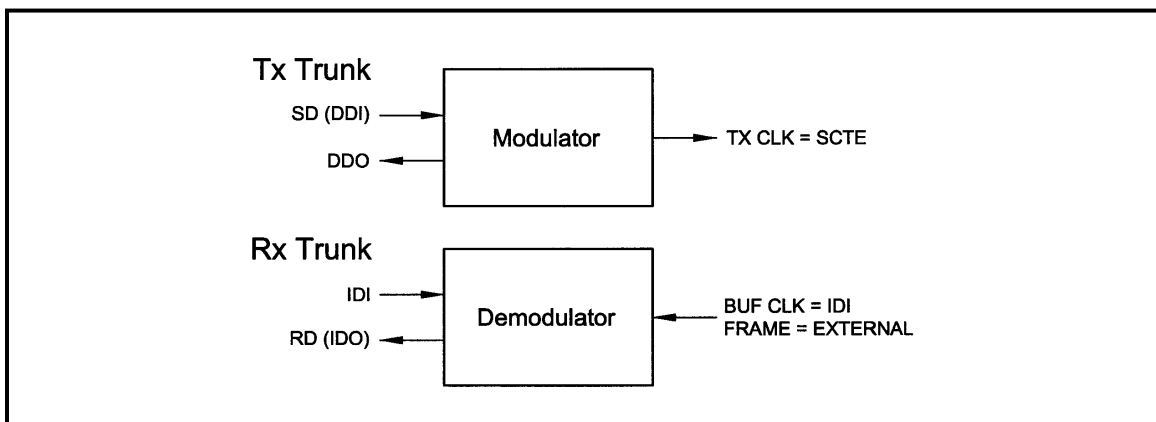

Figure H-7 Transmit Trunk and Receive Trunk

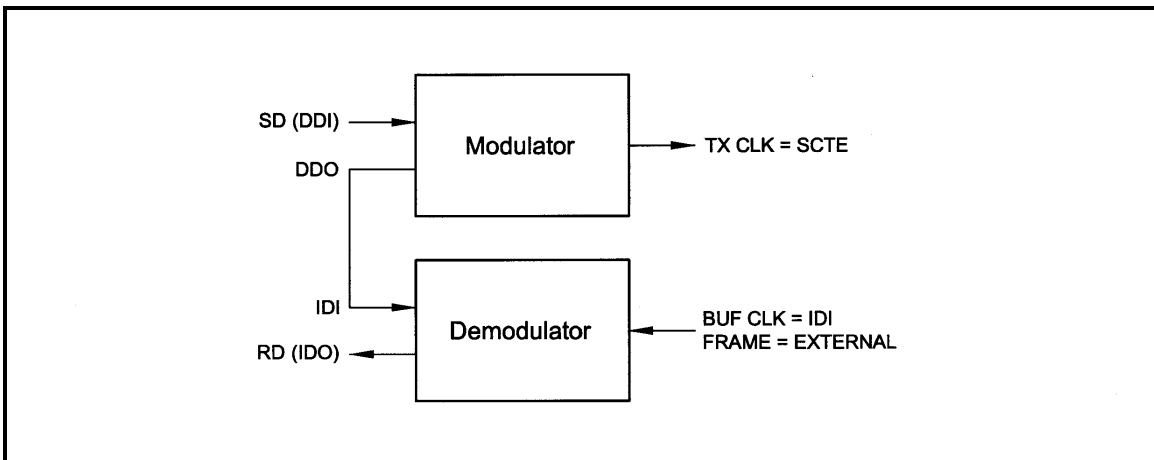

Figure H-8 Single Truck

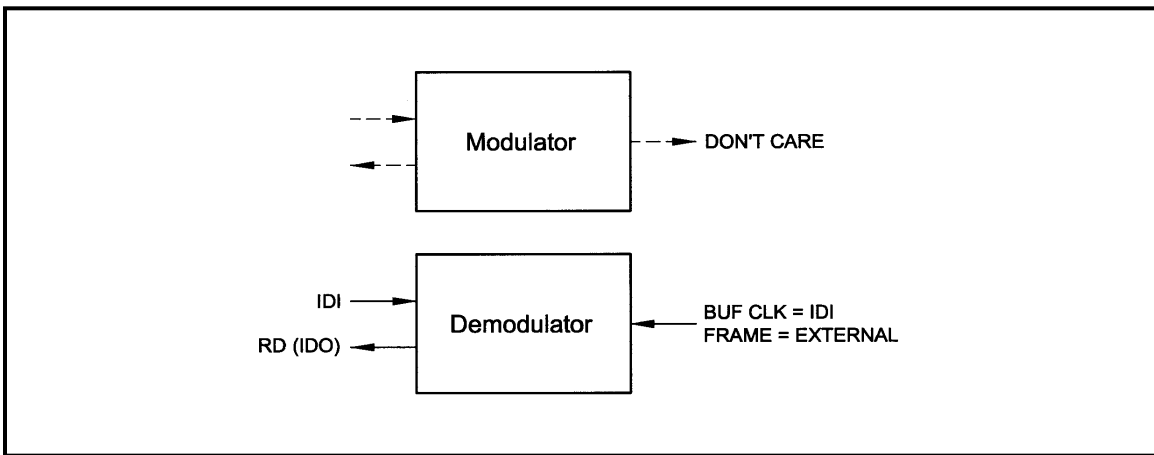

Figure H-9 Rx Only With Trunk

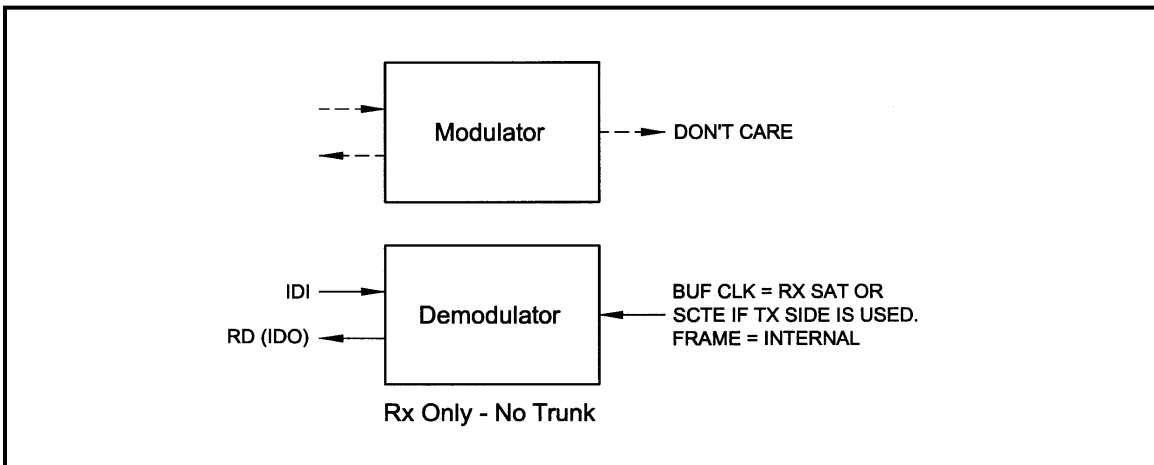

Figure H-10 Rx Only No Trunk

H.3 D&I Maps and Map Editing

The Drop and Insert multiplexer is programmed by loading it with a transmit and receive map. Maps always contain 30 entries, although, only the first “n” entries are relevant (see Table 4-5).

The modem includes provisions to copy, change, and store the D&I transmit and receive maps directly from the Front Panel or via the remote M&C link. These maps are tables that are used to define and configure the D&I functions. Each map contains up to 30 entries, which are enough to define the channel assignments for a T1 (24 channel) or E1 (30 channel) frame structure. Maps that are created are stored in non-volatile battery backed-up memory within the modem and remain unchanged after a power-down.

Data Rate (Kbps)	Map Locations Used (n = 1, 2,4,8,16,24,30)
64	1
128	1-2
256	1-4
384	1-6
512	1-8
768	1-12
1024	1-16
1536	1-24
1920	1-30

It is important to understand that each map contains up to 30 usable entries. In many cases a smaller number of entries will be relevant, except when the data rate is 1920 Kbps, in which case 30 entries will be used by the multiplexer. To determine the number of relevant entries, divide the data rate by 64 Kbps.

For example:

At 384 Kbps, $384/64 = 6$ entries.

Therefore, in this case only the first six entries of the map would be relevant.

The Modem is equipped with eight permanently stored default maps, which are designated ROM 1 through ROM 8. The user may also define, modify, and save an additional eight maps which are designated USER 1 through USER 8.



ROM maps are read-only and may not be modified (refer to Table H-2).

ROM Map	T1/E1 Time Slot																																
	#	1	2	3	4	5	6	7	8	9	10	11	12	13	14	15	16	17	18	19	20	21	22	23	24	25	26	27	28	29	30		
1	1	1	1	1	1	1	1	1	1	1	1	1	1	1	1	1	1	1	1	1	1	1	1	1	1	1	1	1	1	1	1	1	
2	1	2	1	2	1	2	1	2	1	2	1	2	1	2	1	2	1	2	1	2	1	2	1	2	1	2	1	2	1	2	1	2	
3	1	2	3	4	1	2	3	4	1	2	3	4	1	2	3	4	1	2	3	4	1	2	3	4	1	2	3	4	1	2	3	4	
4	1	2	3	4	5	6	1	2	3	4	5	6	1	2	3	4	5	6	1	2	3	4	5	6	1	2	3	4	5	6	1	2	
5	1	2	3	4	5	6	7	8	1	2	3	4	5	6	7	8	1	2	3	4	5	6	7	8	1	2	3	4	5	6	7	8	
6	1	2	3	4	5	6	7	8	9	10	11	12	1	2	3	4	5	6	7	8	9	10	11	12	1	2	3	4	5	6	7	8	
7	1	2	3	4	5	6	7	8	9	10	11	12	13	14	15	16	17	18	19	20	21	22	23	24	25	26	27	28	29	30			
8	1	2	3	4	5	6	7	8	9	10	11	12	13	14	15	17	18	19	20	21	22	23	24	25	26	27	28	29	30	31			

Since the D&I Functions are separate and distinct, two separate maps must be configured at the start of the D&I Multiplexer Operation. These are the Tx (transmit) Active Map for Drop Mapping and the Rx (receive) Active Map for Insert Mapping. The number of entries in each map is determined by the data rates selected. Each map entry consists of an IBS Time Slot assignment and the Terrestrial (T1 or E1) Channel Number to which it is assigned. Drop Mapping and Insert Mapping are completely separate and independent.

The map that is actually used for the Drop Function is the Tx Active Map; the map that is actually used for the Insert function is the Rx Active Map. Two additional maps exist: the Tx Edit Map and the Rx Edit Map. The Edit Maps are the buffer areas that are used when creating or modifying a map through the modem's LCD; when editing is complete, the appropriate map should be copied to the Active Map.

Any map may be copied to any other map with the exception of the ROM maps. These maps may only be the source of the data used to create a User, Edit, or Active Map.

Maps can be created in the map editor and stored as "User Maps". New "Active Maps" can be downloaded during Modem Operation but this will result in a temporary disruption of service on the terrestrial line or the Satellite transmission.

The following paragraphs give examples of typical configurations that could use the ROM Maps as templates. The ROM Map used would have to be first copied to the appropriate Active Transmit (Drop) and/or Active Receive (Insert) Map(s) before it could be used. To use a modification of a ROM Map, the ROM Map must first be copied to the appropriate Edit Map, then modified, and then copied to the appropriate Active Map.



The mapping of channels to time slots is arbitrary; it is not necessary to map CH1 to TS1, CH2 to TS2, etc. The channel to the time slot mapping may be in any order within the constraints of the number of available channels.

For example, ROM Map 1 could be used as the template for an Active Transmit (Drop) Map within a modulator configured for 64 Kbps operation. Only the first time slot of the T1 or E1 frame would be dropped into the modulator transmit path. The Drop Multiplexer would know to look only at the first entry in the Active Transmit table and would ignore the other 29 entries. If the map contained an "8" in its first entry, the eighth channel of the T1/E1 frame would be sent to the modulator.

ROM Map 2 could be used as the template for an Active Receive (Insert) Map within a demodulator configured for 128 Kbps operation. The demodulated data in the receive path would be inserted into the first two time slots of the T1 or E1 frame. The Insert Multiplexer would know to look only at the first two entries in the Active Receive table and would ignore the other 28 entries. If the first two entries were modified to contain a 27 and 28, the data would be inserted into the 27th and 28th time slots of the E1 frame.

ROM Map 3 could be used as the template for an Active Transmit (Drop) Map with a modulator and/or demodulator configured for 256 Kbps operation. The T1 or E1 Data in the transmit path or the demodulated data in the receive path would be dropped from and/or inserted into the first four time slots of the T1 or E1 frame. The Multiplexer would know to look only at the first four entries in the Active map(s) and would ignore the other 26 entries.

ROM Map 4 could be used as the template for an Active Transmit (Drop) or Active Receive (Insert) Map with a modulator and/or demodulator configured for 384 Kbps operation. The T1 or E1 Data in the transmit path or the demodulated data in the receive path would be dropped from and/or inserted into the first six time slots of the T1 or E1 frame. The Insert Multiplexer would know to look only at the first six entries in the Active map(s) and would ignore the other 24 entries. To Drop the last six channels of a T1 frame into a modulator transmit path, the first six entries of the Active Transmit map should contain 19, 20, 21, 22, 23, and 24.

ROM Map 5 could be used as the template for an Active Transmit (Drop) and/or Active Receive (Insert) Map with a modulator and/or demodulator configured for 512 Kbps operation. The T1 or E1 Data in the transmit path or the demodulated data in the receive path would be dropped from and or inserted into the first eight time slots of the T1 or E1 frame. The Multiplexer would know to look only at the first eight entries in the Active map(s) and would ignore the other 22 entries. To insert data received from a demodulator into channels 17 through 24 of an E1 frame, the first eight entries of the Active Receive map should contain 17, 18, 19, 20, 21, 22, 23, and 24.

ROM Map 6 could be used as the template for an Active Transmit (Drop) and/or Active Receive (Insert) Map with a modulator and/or demodulator configured for 768 Kbps operation. The T1 or E1 Data in the transmit path or the demodulated data in the receive path would be dropped from and or inserted into the first 12 time slots of the T1 or E1 frame. The Multiplexer would know to look only at the first 12 entries in the Active map(s) and would ignore the other 18 entries. To insert data received from a demodulator into channels 3 through 14 of an E1 frame, the first 12 entries of the Active Receive map should contain 3, 4, 5, 6, 7, 8, 9, 10, 11, 12, 13, and 14.

ROM Map 7 could be used as the template for an Active Transmit (Drop) and/or Active Receive (Insert) Map with a modulator and/or demodulator configured for 1920 Kbps operation. This would be used with E1 frames where time slot 16 is not used for the multiframe alignment signal and therefore channels 1 through 30 are mapped directly with time slots 1 through 30.

ROM Map 7 could also be used as the template for an Active Transmit (Drop) and/or Active Receive (Insert) Map with a modulator and/or demodulator configured for 1024 Kbps operation. This would be used with T1 or E1 frames where channels 1 through 16 are mapped into time slots 1 through 16 (in any order). Map slots 17 through 30 would be ignored.

ROM Map 7 could also be used as the template for an Active Transmit (Drop) and/or Active Receive (Insert) Map with a modulator and/or demodulator configured for 1536 Kbps operation. This would be used with T1 frames where channels 1 through 24 are mapped into time slots 1 through 24 (in any order). Map slots 25 through 30 would be ignored.

ROM Map 8 could also be used as the template for an Active Transmit (Drop) and/or Active Receive (Insert) Map with a modulator and/or demodulator configured for 1920 Kbps operation. However, this mapping would be relevant with E1 frames where time slot 16 is used for the multiframe alignment signal and therefore channels 1 through 30 are mapped to time slots 1 through 16 and 17 through 31.

BLANK PAGE

Appendix I. Efficient Drop and Insert (D&I)

I.1 Introduction

The menu structure and procedure to configure a modem for Efficient Drop & Insert Mode follow.

I.2 Prerequisite

To be configured for Efficient Drop & Insert, the modem must have a G.703 Interface card installed and Drop & Insert option must be enabled. If the modem does not have the required hardware and/or feature set enabled, contact Comtech to order the appropriate hardware and/or feature set upgrade. If the modem has the appropriate hardware, but the software revision is prior to AY, you will need to download the latest modem firmware from the Radyne FTP website.

The following menus show how to find out if the modem has the required prerequisites.

```
SYSTEM
  HW/FW CONFIG
    FIRMWARE
      F05058-AY 6.1           or later required

SYSTEM
  HW/FW CONFIG
    TERR INTFC BRD
      01-AS/4975             or later equivalent required

SYSTEM
  HW/FW CONFIG
    FEATURES
      UPGRADE LIST
        D&I
          INSTALLED           required

        ENH ASYNC
          INSTALLED           optional, required if desired

        AUPC
          INSTALLED           optional, required if desired
```

I.3 Efficient Drop & Insert Mode

With Efficient Drop & Insert, the terrestrial interface selections, terrestrial framing modes, terrestrial to satellite mapping, ES to ES channel, satellite and terrestrial backward alarm functionality, and the In Station Prompt and Deferred Service alarm operation are identical to that of the Drop & Insert Open Network standard. In addition, the selection and operation of Enhanced Async and AUPC are identical to their closed network IBS counterparts. For more information on these selections, refer to the appropriate section of the User's manual.

The following menu selections are utilized for controlling the additional functionality available with efficient Drop and Insert:

MODULATOR or DEMODULATOR

NETWORK SPEC

CLOSED NET Efficient Drop & Insert is a Closed Network selection

SAT FRAMING

EFFICIENT D&I The satellite frame type is Efficient Drop & Insert

DATA

DATA RATE (bps)
N x 64000

The data rate can be set to any N x 64 kbps rate based on the desired number of drop or insert slots. The following values of N are allowed based on the terrestrial interface and terrestrial framing types shown

T1	Any framing	Any N from 1 to 24
E1	Any PCM31	Any N from 1 to 31
E1	Any PCM30	Any N from 1 to 30 as TS 16 is automatically transmitted

SCRAMBLER CTRL

DISABLED The Efficient Drop & Insert mode utilizes a frame synchronous energy dispersal technique that is always on, thus there is no need for any additional scrambling

INBAND RATE

150
300
600
1200
2400
4800
9600
19200

This Menu is available when enhanced async is enabled. This field allows the operator to select a desired Earth Station to Earth Station in-band rate. This allows the user to optimized the In-Band Rate based on the amount of traffic that will pass over the satellite. In most cases, this should be set to the same rate or higher than the TX & RX Async/ES port baud rate. When this rate is set lower than the ES port baud rate, the user must insure that the actual ES to ES transmission rate does not exceed the In-Band Rate, otherwise characters will be dropped.

I.3.1 Calculating the Required Satellite Bandwidth

In order to calculate the satellite bandwidth (i.e. the symbol rate), we must first calculate the Efficient D&I Rate (i.e. the data rate plus the overhead required for Efficient Drop & Insert). From there, the calculation of the required satellite bandwidth is identical to all other modes of operation and simply takes into account modulation type and forward error correction.

In this section, we will cover the calculation of the basic Efficient D&I Rate, as well as, the two cases that alter the basic rate.

I.3.2 Calculating the Basic Efficient D&I Rate

When E1 signaling is not required (all T1 and PCM31 cases) and Enhanced Async is not enabled (the Earth Station to Earth Station link is the standard ES-ES), the Efficient D&I Rate for N timeslots is as follows:

$$\text{Efficient D\&I Rate} = \text{Data Rate} + (N * 250 \text{ bps})$$

In other words, the basic Efficient Drop & Insert Rate only requires 250 bps of overhead per slot, while at the same time providing all of the functionality found in the Drop & Insert open network standard plus Automatic Uplink Power Control. By comparison, the Drop & Insert open network standard requires 4267 bps per slot, so by utilizing Efficient Drop and Insert, Radyne customers can realize a bandwidth savings of over 4000 bps per slot.

I.3.3 Calculating the Efficient D&I Rate with E1 Signaling

When E1 signaling is enabled (PCM-30, PCM30C), an additional 2000 bps per slot are required to carry the E1 signaling. So the Efficient D&I Rate for N timeslots is:

$$\text{Efficient D\&I Rate increase} = N * 2000 \text{ bps}$$

With the Drop & Insert open network standard requiring 4267 bps per slot, Efficient Drop and Insert provides a bandwidth savings of over 2000 bps per slot when E1 signaling is required.

I.3.4 Calculating the Efficient D&I Rate with Enhanced Asynchronous Overhead

The amount of overhead required to carry the Enhanced Async is driven by the in-band baud rate. The calculation is a two step process involving the in-band baud rate and the number of slots as follows:

$$X = \text{Truncation of } (\text{In-Band Baud Rate} / (N * 125))$$

$$\text{Efficient D\&I Rate increase} = X * N * 125 \text{ bps}$$

Because of the truncation, this increase in bandwidth is guaranteed to be less than the baud rate itself.

I.3.4.1 Summary and Examples:

These examples illustrate how to calculate the Efficient D&I rate, which can be summarized for N timeslots as:

$$\text{Efficient D\&I Rate} = \text{Data Rate} + (N * 250 \text{ bps})$$

With E1 signaling add

$$N * 2000 \text{ bps}$$

With Enhanced Async add

$$(\text{Truncation}(\text{In-Band Baud} / (N * 125))) * (N * 125) \text{ bps}$$

Example 1a:

5 Drop Slots with T1-D4 framing, standard ES to ES overhead

For 5 Drop Slots, the Data Rate would be $5 * 64000$ or 320000 bps

The Efficient D&I Rate would be $320000 + (5 * 250)$ bps = 321250 bps

The Drop & Insert Open Network rate is over 20,000 bps higher at 341333 bps.

Example 1b:

Change to E1-PCM30 framing (E1 Signaling), standard ES to ES overhead

Add $5 * 2000$ bps to our previous calculation gives 331250 bps

Still saving over 10,000 bps compared to the open network standard.

Example 1c:

Change to Enhanced Async with In-Band Baud Rate of 1200

$X = \text{Truncation of } (1200 / (5 * 125))$

$X = \text{Truncation of } (1.92)$

$X = 1$

Add $1 * 5 * 125$ bps to our previous calculation gives 331875 bps

An increase of 625 bps to carry 1200 baud

Example 2a:

10 Drop Slots with T1-D4 framing, standard ES to ES overhead

For 10 Drop Slots, the Data Rate would be $10 * 64000$ or 640000 bps

The Efficient D&I Rate would be $640000 + (10 * 250)$ bps = 642500 bps

The Drop & Insert Open Network rate is over 40,000 bps higher at 682667 bps.

Example 2b:

Change to E1-PCM30 framing (E1 Signaling), standard ES to ES overhead

Add $10 * 2000$ bps to our previous calculation gives 662500 bps

Still saving over 20,000 bps compared to the Drop & Insert open network standard.

Example 2c:

Change to Enhanced Async with In-Band Baud Rate of 1200

$X = \text{Truncation of } (1200 / (10 * 125))$

$X = \text{Truncation of } (0.96)$

$X = 0$

The rate stays at the previous value of 662500

With 10 slots, there is no increase required to carry 1200 baud Enhanced Async. It is passed transparently in the Efficient Drop & Insert overhead.

BLANK PAGE

Appendix J. Ethernet Data Interface Setup

J.1 Configure the modem to use the Ethernet Data Interface (Optional)

When the optional 10/100 or 10/100/1000 Base-T Ethernet Data Interface Card is installed, all of the Ethernet related menus become available and can be used to control the interface as follows:

Under the Interface Menu:

Under the Tx Setup Menu:

- Set the Terrestrial Interface to Ethernet.
- Set the Ethernet Flow Control as desired (refer to Section 4.8.1 for details).
- Set the Ethernet Daisy Chain as desired (refer to Section 4.8.2 for details).
- Set the Ethernet QOS Type as desired (refer to Section 4.8.3 for details).
- Set the Ethernet QOS Queue as desired (refer to Section 4.8.4 for details).
- Set the Tx Clock to SCTE.

Set the Tx Clock Polarity to Normal.

Under the Interface Menu:

Under the Rx Setup Menu:

- Set the Terrestrial Interface to Ethernet.
- Set the Buffer Size to Zero.
- Set the Buffer Clock to Rx Sat.
- Set the Buffer Clock Polarity to Normal.

When Ethernet Data Interface is selected, the Tx Clock Source will default to SCTE and the Clock Polarity will default to Normal. In addition, the Buffer Clock will default to RxSat and the Buffer Clock Polarity will default to Normal.



The DMD20 supports Radyne HDLC and Comtech HDLC modes, offering compatibility with the SLM5650A Bridge Interface.

J.1.1 Ethernet Flow Control

When disabled, if a packet is received for transmission and no packet buffer space is available, the incoming packet is discarded.

When enabled, flow control is used to throttle the transmission station in order to avoid overrunning the transmit buffers, which would in turn cause packets to be dropped. The throttling mechanism used depends upon the interface and whether it is half-duplex or full duplex.

J.1.1.1 Half-Duplex Flow Control

In half-duplex mode, the unit uses industry standard backpressure to support flow control as follows:

When available buffer space is almost gone, the modem will force a collision on the input port when it senses an incoming packet. This collision will cause the transmitting station to back off and retry the transmission.

The interface will stop forcing collisions as soon as free buffer space becomes available.

J.1.1.2 Full-Duplex Flow Control

In full-duplex mode, the interface implements IEEE 8802.3x flow control as follows:

When available buffer space is almost gone, the unit sends out a pause frame with the maximum pause time to stop the remote nodes from transmitting.

The interface sends out another pause frame with the pause time set to zero as soon as free buffer space becomes available.

J.1.2 Ethernet Daisy Chain

When disabled, Port 4 (JS4) on the Ethernet Data Interface operates normally. Data received on Port 4 that is not addressed to other equipment on the LAN side, is transmitted over the satellite.

When Port 4 is selected for Daisy Chain, any data received on Port 4 (JS4) is forwarded to of the other LAN side ports (Ports 1 - 3) and is not transmitted over the satellite. This is extremely useful in a point-to -multipoint configuration as illustrated in Figure J-1.

J.1.3 Ethernet QOS Type

When Normal QOS is selected, the interface determines a packets priority based on the following:

- IEEE 803.3ac Tag when present
- IPv4 Type of Service / Differentiated Services Field
- Ipv6 Traffic Class

When Port Based QOS is selected, the interface determines the priority of a packed based upon the port on which it arrived.

- Port 1 (JS1) has the highest priority
- Port 2 (JS2) has the second highest priority
- Port 3 (JS3) has the second lowest priority
- Port 4 (JS4) has the lowest priority

J.1.4 Ethernet QOS Queue

When Fair Weighted queueing is selected, the interface transmits packets at a rate of 8, 4, 2, and 1 from the highest priority queue to the lowest respectively. With fair weighted queueing, all queues with data in them are guaranteed to receive some bandwidth.

When Strict Priority is selected, the interface transmits packets from the highest priority queue until it is empty. It then begins transmitting data from the next highest priority queue. If higher priority data arrives, the interface finishes the current packet and then goes back to transmitting packets from the higher priority queue until it is again empty. Care must be taken when selecting Strict Priority, as it is entirely possible for the lower priority queues to be stalled indefinitely.

J.1.5 Set up the Ethernet Bridge to operate like a FIFO

In certain circumstances, it may be desirable to have the Ethernet interface operate in a FIFO like manner with no reordering of packets. This can be established by using a single port on the Ethernet interface and setting the Ethernet QOS Type to Port Based and the Ethernet QOS Queue to Strict Priority. When Setup and used in this manner, the packets will be transmitted in the exact order in which they are received.

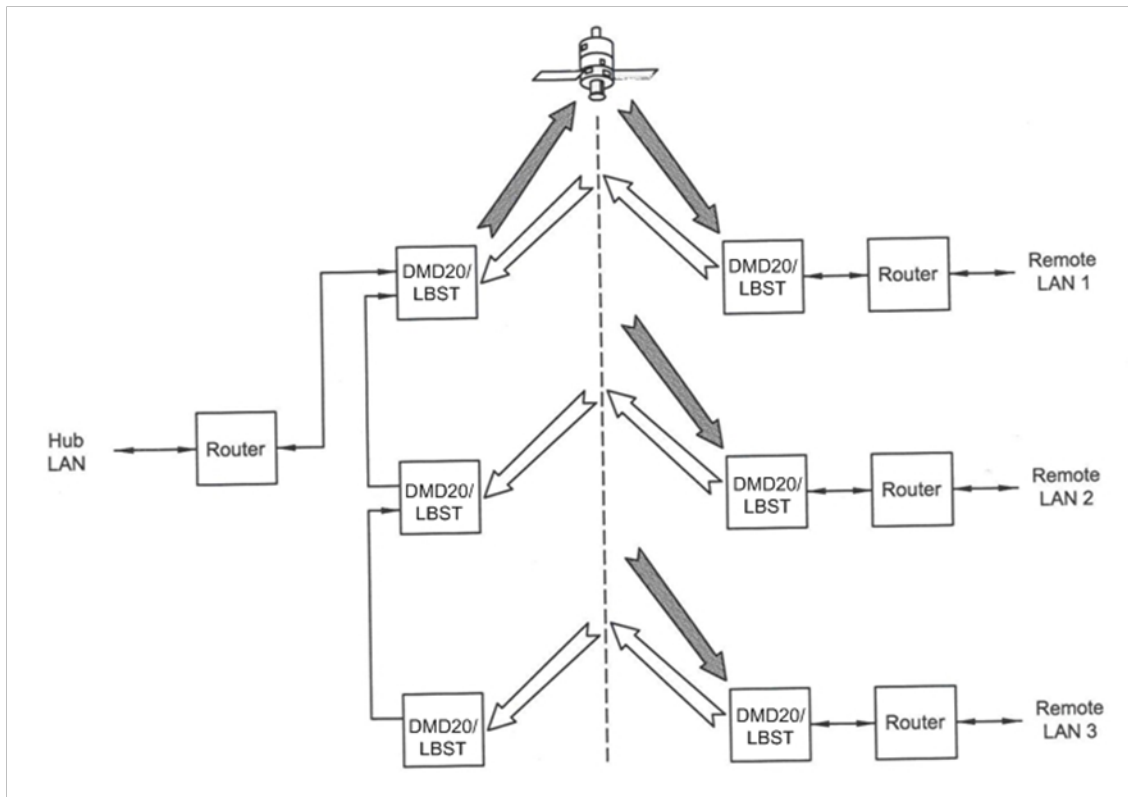

Figure J-1. Point-to-Multipoint with Daisy Chaining

J.1.6 Packet Statistics

The following statistics are available under the Monitor Menu when the Ethernet Data Interface is selected.

Total Packets: This Counter displays the total number of Ethernet packets received from the satellite.

Error Packets: This counter displays the total number of Ethernet packets received from the satellite that had errors.

Packet Error Rate: This displays the Ethernet Packet Error Rate (PER) from the satellite.

Packet Statistics Reset: Allows the user to reset the Ethernet Total Packets and Ethernet Error Count by pressing <Enter>.

Link Status: The following status is available under the Monitor Menu/Link Status Sub-Menu when the Ethernet Data Interface is selected:

Port 1 Status: Displays the current status of LAN Port 1.

Port 2 Status: Displays the current status of LAN Port 2.

Port 3 Status: Displays the current status of LAN Port 3.

WAN Status: Displays the current status of the WAN Port.

For each of the above-listed ports, the status may take on one of the following values/meanings.

Down:	The link is down.
Unresolved:	Unable to agree on connection speed.
10 Mbps Half:	Connected at 10 Base-T Half Duplex.
10 Mbps Full:	Connected at 10 Base-T Full Duplex.
100 Mbps Half:	Connected at 100 Base-T Half Duplex.
100 Mbps Full:	Connected at 100 Base-T Full Duplex.

If all four LAN Ports are down, a Tx Data Activity Minor Alarm will be generated.

If the WAN Port is down, ax and Rx Ethernet WAN Major Alarm will be generated.

METRIC CONVERSIONS

Units of Length

Unit	Millimeter	Centimeter	Inch	Foot	Yard	Meter	Kilometer	Mile
1 millimeter	1	0.1	0.0394	0.0033	0.0011	0.001	1×10^{-6}	6.214×10^{-7}
1 centimeter	10	1	0.3937	0.0328	0.0109	0.01	1×10^{-5}	6.214×10^{-6}
1 inch	25.4	2.54	1	0.0833	0.0278	0.0254	2.54×10^{-5}	1.578×10^{-5}
1 foot	304.8	30.48	12	1	0.3333	0.3048	3.048×10^{-4}	1.894×10^{-4}
1 yard	914.4	91.44	36	3	1	0.9144	9.144×10^{-4}	5.682×10^{-4}
1 meter	1000	100	39.37	3.2808	1.0936	1	0.001	6.214×10^{-4}
1 kilometer	1×10^6	1×10^5	3.938×10^4	3.281	1093	1000	1	0.6214
1 mile	1.609×10^6	1.609×10^5	6.336×10^4	5280	1760	1609	1.609	1

Temperature Conversions

Temperature	° Fahrenheit	° Centigrade
Water freezes	32	0
Water boils	212	100
Absolute zero	-459.69	-273.16

Formulas
$^{\circ}C = (F - 32) * 0.555$
$^{\circ}F = (C * 1.8) + 32$

Units of Weight

Unit	Gram	Ounce Avoirdupois	Ounce Troy	Pound Avoirdupois	Pound Troy	Kilogram
1 gram	1	0.03527	0.03215	0.002205	0.002679	0.001
1 oz. avoird.	28.35	1	0.9115	0.0625	0.07595	0.02835
1 oz. troy	31.10	1.097	1	0.06857	0.08333	0.03110
1 lb. avoird.	453.6	16.0	14.58	1	1.215	0.4536
1 lb. Troy	373.2	13.17	12.0	0.8229	1	0.3732
1 kilogram	1000	35.27	32.15	2.205	2.679	1



2114 WEST 7TH STREET TEMPE ARIZONA 85281 USA
480 • 333 • 2200 PHONE
480 • 333 • 2161 FAX