



SMS-301

Redundancy Switch Installation and Operation Manual

Revision 3
November 19, 1999

Copyright © Comtech EFData, 2000. All rights reserved. Printed in the USA.
Comtech EFData, 2114 West 7th Street, Tempe, Arizona 85281 USA, (480) 333-2200, FAX: (480) 333-2161.

Customer Support

Contact the Comtech EFData Customer Support Department for:

- Product support or training
- Information on upgrading or returning a product
- Reporting comments or suggestions concerning manuals

A Customer Support representative may be reached at:

Comtech EFData
Attention: Customer Support Department
2114 West 7th Street
Tempe, Arizona 85281 USA

(480) 333-2200 (Main Comtech EFData Number)
(480) 333-4357 (Customer Support Desk)
(480) 333-2161 FAX

or, E-Mail can be sent to the Customer Support Department at:

service@comtechefdata.com

Contact us via the web at www.comtechefdata.com.

1. To return a Comtech EFData product (in-warranty and out-of-warranty) for repair or replacement:
2. Request a Return Material Authorization (RMA) number from the Comtech EFData Customer Support Department.
3. Be prepared to supply the Customer Support representative with the model number, serial number, and a description of the problem.
4. To ensure that the product is not damaged during shipping, pack the product in its original shipping carton/packaging.
5. Ship the product back to Comtech EFData. (Shipping charges should be prepaid.)

For more information regarding the warranty policies, see Warranty Policy, p. xi.

Table of Contents

CHAPTER 1. INTRODUCTION.....	1-1
1.1 Description.....	1-2
1.1.1 Description (Standard Configuration).....	1-2
1.1.2 Description (With RS-301 Option).....	1-3
1.1.3 Board List.....	1-4
1.2 Front Panel.....	1-5
1.3 Specifications.....	1-6
CHAPTER 2. INSTALLATION.....	2-1
2.1 Unpacking.....	2-1
2.2 System Installation.....	2-2
2.3 External Connections.....	2-3
2.3.1 Remote Switch Control (J1) (RS-301 Option).....	2-5
2.3.2 Data I/O Connections.....	2-6
2.3.2.1 Data I/O Connector (J1, J2, J3), 50-Pin (PL/5951).....	2-6
2.3.2.2 Data I/O Connector (J1, J2, J3), 37-Pin (PL/5952).....	2-7
2.3.2.3 Data I/O Connector (J1, J2, J3), 25-Pin (PL/6026).....	2-8
2.3.2.4 Data I/O (J1, J2, J3) 37-Pin (PL/6201-1).....	2-9
2.3.2.5 Data I/O Connector (J1, J2, J3) 37-Pin (PL/6201-2).....	2-10
2.3.2.6 100 Pin interface (RS-301 Option) (PL/6542/PL/6627).....	2-11
2.3.3 Transmit IF Connectors (J4, J5, J6).....	2-13
2.3.4 RX IF Connectors (J7, J8, J9).....	2-13
2.3.5 Remote Control Interface Connector (J10).....	2-14
2.3.6 Prime Power.....	2-15
2.3.6.1 AC Power (J11 and J12).....	2-15
2.3.6.2 DC Power (J11 and J12) (Optional).....	2-15
2.3.7 Switch/Modem Communications Interface Connector (J13).....	2-16
2.3.8 Status/Fault (J14).....	2-17
2.3.9 IF Connections: Transmit and Receive.....	2-17
2.3.10 Ground.....	2-17

CHAPTER 3. OPERATION	3-1
3.1 Configuration	3-1
3.2 Setup and Configuration	3-2
3.2.1 Utility System.....	3-3
3.2.2 Configuration	3-3
3.2.2.1 Prime	3-3
3.2.2.2 Backup	3-4
3.2.2.3 Operation Mode	3-5
3.3 Faults.....	3-5
3.4 Front Panel Keypad	3-6
3.5 Menu System	3-7
3.5.1 Front Panel Menus	3-9
3.5.1.1 Configuration Switch Control Menu.....	3-11
3.5.1.2 Configuration System Menu	3-13
3.5.1.3 Configuration Save Menu	3-15
3.5.1.4 Configuration Recall Menu.....	3-16
3.5.1.5 Monitor Menu	3-17
3.5.1.6 Faults/Alarms	3-19
3.5.1.7 Stored Faults/Alarms.....	3-21
3.5.1.8 Utility System.....	3-23
3.5.1.9 Utility Modem Control.....	3-27
CHAPTER 4. THEORY OF OPERATION	4-1
4.1 Monitor and Control (M&C)	4-1
4.1.1 Theory of Operation.....	4-2
4.2 SMS-301 Data Interface	4-3
4.2.1 IBS, IDR, ASYNC, or D&I (J1, J2, J3), 50-Pin (PL/5951)	4-3
4.2.2 EIA-422/-449, G.703, or V.35 (J1, J2, J3), 37-Pin (PL/5952)	4-3
4.2.3 LVDS-DVB TX, (J1, J2, J3), 37-Pin, (PL/6201-1).....	4-3
4.2.4 EIA-422/DVB TX (J1, J2, J3), 25-Pin (PL/6026).....	4-4
4.3 Remote Switch (RS-301) Option	4-5
CHAPTER 5. MAINTENANCE.....	5-1
5.1 Software Revisions	5-1
5.2 Test Points and LEDs.....	5-3
5.3 Fault Isolation.....	5-4

APPENDIX A. REMOTE CONTROL OPERATION A-1

A.1	General.....	A-1
A.2	Message Structure.....	A-2
A.2.1	Start Character.....	A-2
A.2.2	Device Address	A-3
A.2.3	Command/Response.....	A-3
A.2.4	End Character.....	A-4
A.3	Configuration Commands/Responses.....	A-5
A.4	Modem Communications Configuration Commands/Responses.....	A-6
A.5	System Commands/Responses	A-7
A.6	Status Commands/Responses	A-8
A.7	Fault Summary Status Commands/Responses	A-9
A.8	Stored Faults.....	A-10

APPENDIX B. SDM-300/-300A SYSTEM INSTALLATIONS..... B-1

B.1	System Installation.....	B-1
B.1.1	System Installation (Standard Configuration).....	B-2
B.1.2	System Installation (RS-301 Switch Installed).....	B-5
B.1.3	Connect System Installation with RS-301 Switch.....	B-6

APPENDIX C SDM-2020 SYSTEM INSTALLATIONS C-1

C.1	Installation Options.....	C-1
C.1.1	Connect Low Voltage Differential Signal Interface (Optional)	C-1
C.1.1.1	Description	C-1
C.1.1.2	Connect to SDM-2020 Modulator with LVDS Interface	C-3
C.1.2	Connect to SDM-2020 Satellite Modulator with EIA-422 Interface.....	C-4
C.1.2.1	Description.....	C-4
C.1.2.2	Connect to SDM-2020 Modulator with EIA-422 Interface.....	C-5
C.1.3	Connect to SDM-2020 Satellite Modulator with EIA-422 DVB TX Interface.....	C-6
C.1.3.1	Description.....	C-6
C.1.3.2	Connect to SDM-2020 Modulator with EIA-422 DVB TX Interface.....	C-7
C.1.4	Connect to SDM-2020 Satellite Modulator with EIA-422 (DVB) TX Interface (100 Mbit/s)	C-9
C.1.4.1	Description.....	C-9
C.1.4.2	Connect to SDM-2020 Modulator with EIA-422 DVB TX Interface.....	C-10
C.1.5	Connect to SDM-2020 Satellite Modulator I/O Connector, 25-Pin Interface	C-12
C.1.5.1	Description.....	C-12
C.1.5.2	Connect to SDM-2020 Modulator with I/O Connector, 25-Pin Interface	C-12

GLOSSARY g-1**INDEX i-1**

Figures

Figure 1-1. SMS-301	1-1
Figure 1-2. System Block Diagram (Standard Configuration)	1-2
Figure 1-3. System Block Diagram (With RS-301 Option).....	1-3
Figure 2-1. SMS-301 Rear Panel Configurations	2-3
Figure 3-1. SMS-301 Front Panel View	3-1
Figure 3-2. Keypad	3-6
Figure 3-3. Main Menu	3-9
Figure 3-4. Configuration Switch Control Menu.....	3-10
Figure 3-5. Configuration System Menu	3-12
Figure 3-6. Configuration Save Menu	3-15
Figure 3-7. Configuration Recall Menu.....	3-16
Figure 3-8. Monitor Menu	3-17
Figure 3-9. Faults/Alarms Menu.....	3-18
Figure 3-10. Stored Faults/Alarms Menu	3-20
Figure 3-11. Utility System Menu	3-22
Figure 3-12. Utility Modem Control Menu	3-26
Figure B-1. System Installation (Standard Configuration)	B-3
Figure B-2. System Installation (RS-301 Installed).....	B-6
Figure C-1. Connect to SDM-2020 Modulator with LVDS Interface	C-3
Figure C-2. Connect to SDM-2020 Modulator with EIA-422 Interface.....	C-5
Figure C-3. Connect to SDM-2020 Modulator with EIA-422 (DVB) TX Interface (18 Mbit/s Serial Data).....	C-8
Figure C-4. Connect to SDM-2020 Modulator with EIA-422 (DVB) TX Interface (100 Mbit/s Parallel Data).....	C-11
Figure C-5. Connect to SDM-2020 Modulator with I/O Connector, 25-Pin Interface	C-13

Tables

Table 1-1. Board List	1-4
Table 1-2. LED Status Indicators	1-5
Table 1-3. 1:1 Switch Specifications	1-6
Table 2-1. Rear Panel Connectors (Standard Configuration)	2-4
Table 2-2. Rear Panel Connectors (With RS-301 Option)	2-4
Table 2-3. Switch Control Interface Signals	2-5
Table 2-4. Data I/O Connector, 50-Pin	2-6
Table 2-5. Data I/O Connectors, 37-Pin	2-7
Table 2-6. Connector Assignments, 25-Pin	2-8
Table 2-7. Connector Assignments, 37-Pin	2-9
Table 2-8. Connector Assignments, 37-Pin	2-10
Table 2-9. Data I/O Connector, 100-Pin	2-11
Table 2-10. Remote Control Interface Connector Pinout Data (J10)	2-14
Table 2-11. AC Power (J11 and J12)	2-15
Table 2-12. DC Prime Power (J11 and J12)	2-15
Table 2-13. Switch/Modem Communications Interface Connector (J13)	2-16
Table 2-14. Status/Faults (J14) Pinout Assignments	2-17
Table 3-1. Default Configuration Parameters	3-2
Table 3-2. Keypad Functions	3-6
Table 4-1. Remote Switch (RS-301) Connectors	4-5
Table 4-2. Tributary 1 Data (J1)	4-6
Table 4-3. Tributary 2 Data (J2)	4-6
Table 4-4. Tributary 3 Data (J3)	4-6
Table 4-5. Tributary 4 Data (J4)	4-7
Table 4-6. Tributary 5 Data (J5)	4-7
Table 4-7. Tributary 6 Data (J6)	4-7
Table 4-8. Tributary 7 Data (J7)	4-8
Table 4-9. Tributary 8 Data (J8)	4-8
Table 4-10. AUX Data (J9)	4-8
Table 4-11. Modem A Data (J14)	4-9
Table 4-12. Modem B Data (J15)	4-10
Table 4-13. Switch Control Interface (J16)	4-11
Table 5-1. LED Functions	5-3
Table 5-2. Fault Isolation, 1:1 Switch	5-4
Table B-1. Standard Configuration Cabling	B-2
Table B-2. RS-301 Configuration Cabling	B-5
Table C-1. LVDS/DVB Specifications	C-2
Table C-2. EIA-422/EIA-530 Specifications	C-4
Table C-3. EIA-422/EIA-530 Specifications	C-6
Table C-4. Cable Pin Assignments (CA/6217)	C-7
Table C-5. Cable Pin Assignments (CA/6217)	C-10
Table C-6. Pin Assignments, 25-Pin	C-12

Overview of Changes to Previous Edition

This revision supersedes part number MN/SMS301.IOM Rev. 2, dated February 6, 1998

A summary of the changes made for Rev. 3 includes:

- Various non-technical cosmetic changes (formatting, etc.).
- Add new EMC directive.
- Revised Table 1-1 Board List.
- Revised Table 1-3 to include Control Box Extender Card Connector.
- Revised paragraph 2.2 to relocate cabling instructions to appendices.
- Paragraph 2.3, Rearranged section.
- Added Standard Configuration to Figure 2-1.
- Added Table 2-1 to reflect standard configuration and renumbered Table 2-2 as RS-301 Connectors.
- Reidentified paragraph 2.3.1 as RS-301 option.
- Relocated different installation options from Section 2 to appendices.
- Updated menus to reflect version 1.1.6.
- Deleted Sections 4.6 and 4.7. Data relocated to Chapter 2.
- Revised Chapter 4, to rearrange data interfaces.
- Revised Appendix A to reflect FW/6055-1E.
- Added Appendix B to reflect SDM-300/-300A cabling.
- Added Appendix C to reflect SDM-2020M cabling.

About this Manual

This manual provides installation and operation information for the Comtech EFDData SMS-301 redundancy switch. This is a technical document intended for earth station engineers, technicians, and operators responsible for the operation and maintenance of the SMS-301.

Conventions and References

Cautions and Warnings



CAUTION indicates a hazardous situation that, if not avoided, may result in minor or moderate injury. CAUTION may also be used to indicate other unsafe practices or risks of property damage.



WARNING indicates a potentially hazardous situation that, if not avoided, could result in death or serious injury.

Metric Conversion

Metric conversion information is located on the inside back cover of this manual. This information is provided to assist the operator in cross-referencing English to Metric conversions.

Recommended Standard Designations

Recommended Standard (RS) Designations have been superseded by the new designation of the Electronic Industries Association (EIA). References to the old designations are shown only when depicting actual text displayed on the screen of the unit (RS-232, RS-485, etc.). All other references in the manual will be shown with the EIA designations (EIA-232, EIA-485, etc.) only.

Trademarks

Other product names mentioned in this manual may be trademarks or registered trademarks of their respective companies and are hereby acknowledged.

Reporting Comments or Suggestions Concerning this Manual

Comments and suggestions regarding the content and design of this manual will be appreciated. To submit comments, please contact the Comtech EFData Customer Support Department.

EMC Compliance

EN55022 Compliance

This equipment meets EN5022.

This is a Class A product. In a domestic environment, it may cause radio interference in which the user may be required to take adequate measures.

Federal Communications Commission (FCC)

This equipment has been tested and found to comply with the limits for a Class A digital device, following Part 15 of the FCC rules. These limits are designed to provide reasonable protection against harmful interference when the equipment is operated in a commercial environment.

This equipment generates uses, and can radiate radio frequency energy and, if not installed and used in accordance with the instruction manual, may cause harmful interference to radio communication. Operation of this equipment in a residential area is likely to cause harmful interference in which case the user will be required to correct the interference at his own expense.





Note: To ensure compliance, properly shielded cables for DATA I/O shall be used. More specifically, these cables shall be doubled-shielded from end-to-end, ensuring a continuous shield.

Low Voltage Directive (LVD)

The following information is applicable for the European Low Voltage Directive (EN60950):

<HAR>	Type of power cord required for use in the European Community.
	CAUTION: Double-pole/Neutral Fusing. ACHTUNG: Zweipolige bzw. Neutralleiter-Sicherung.

International Symbols:

	Alternating Current.
	Fuse.
	Safety Ground.
	Chassis Ground.

Note:

1. Applicable testing is routinely performed as a condition of manufacturing on all units to ensure compliance with requirements of EN60950 for Safety.

Warranty Policy

This Comtech EFData product is warranted against defects in material and workmanship for a period of one year from the date of shipment. During the warranty period, Comtech EFData will, at its option, repair or replace products that prove to be defective.

For equipment under warranty, the customer is responsible for freight to Comtech EFData and all related custom, taxes, tariffs, insurance, etc. Comtech EFData is responsible for the freight charges **only** for return of the equipment from the factory to the customer. Comtech EFData will return the equipment by the same method (i.e., Air, Express, Surface) as the equipment was sent to Comtech EFData.

Limitations of Warranty

The foregoing warranty shall not apply to defects resulting from improper installation or maintenance, abuse, unauthorized modification, or operation outside of environmental specifications for the product, or, for damages that occur due to improper repackaging of equipment for return to Comtech EFData.

No other warranty is expressed or implied. Comtech EFData specifically disclaims the implied warranties of merchantability and fitness for particular purpose.

Exclusive Remedies

The remedies provided herein are the buyer's sole and exclusive remedies. Comtech EFData shall not be liable for any direct, indirect, special, incidental, or consequential damages, whether based on contract, tort, or any other legal theory.

Disclaimer

Comtech EFData has reviewed this manual thoroughly in order that it will be an easy-to-use guide to your equipment. All statements, technical information, and recommendations in this manual and in any guides or related documents are believed reliable, but the accuracy and completeness thereof are not guaranteed or warranted, and they are not intended to be, nor should they be understood to be, representations or warranties concerning the products described. Further, Comtech EFData reserves the right to make changes in the specifications of the products described in this manual at any time without notice and without obligation to notify any person of such changes.

If you have any questions regarding your equipment or the information in this manual, please contact the Comtech EFData Customer Support Department.

This page is intentionally blank.

1 Chapter 1. INTRODUCTION

This manual describes the SMS-301 redundancy switch, referred to in this manual as the “1:1 switch” (Figure 1-1).



Figure 1-1. SMS-301

1.1 Description

1.1.1 Description (Standard Configuration)

The 1:1 switch is a fully automated protection switch for Comtech EFData satellite modems, providing redundancy for one prime modem using one identical backup modem. Common interfaces are provided for user data terminal equipment and uplink/downlink RF equipment, as well as the primary and redundant (backup) modems. The integrated uplink 1:1 switch and downlink splitter operate at IF frequencies in the range of 50 to 180 MHz.

Full Monitor and Control (M&C) functions are supported by an integrated microprocessor system. The M&C system is designated to maintain the 1:1 switch configuration settings in non-volatile memory for at least one year without prime power.

Note: While 1:1 switch prime power is not applied, the default connections are to Modem A.

Remote control is provided by an EIA-485 or EIA-232 interface located on the rear panel of the chassis. The rear panel also is the location for all external interconnections. The 1:1 switch is enclosed in a single unit, 19-inch (48.3 cm) rack-mounted chassis. Figure 1-2 illustrates the system block diagram.

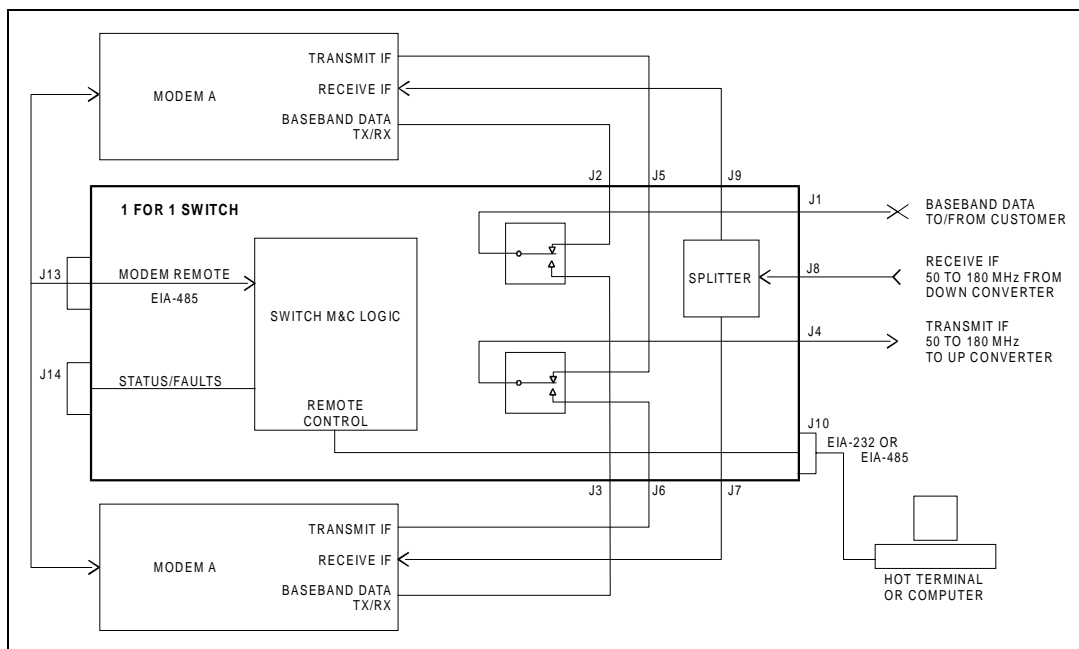

Figure 1-2. System Block Diagram (Standard Configuration)

1.1.2 Description (With RS-301 Option)

The 1:1 switch, when used with the RS-301 Remote Switch, is a fully-automated protection switch designed for use with the Comtech EFData SDM-300/-300A Satellite Modem that are equipped with the 8-Channel MUX option. It provides redundancy for the one prime modem using identical backup satellite modem. The 1:1 switch provides common interfaces for the RF uplink and downlink equipment. The integrated uplink 1:1 switch and downlink splitter operate at IF frequencies in the range of 50 to 180 MHz.

The RS-301 Remote Switch is a separate 19-inch (48.3 cm) rack-mounted chassis. It is controlled by the 1:1 switch, and provides redundancy for the data interface between the primary modem, backup modem, and customer equipment. The front panel provides convenient access to eight tributary data channels (EIA-232 and EIA-422 clock and data) and one auxiliary data channel. Figure 1-3 illustrates the system block diagram.

Note: The default connections are to Modem A.

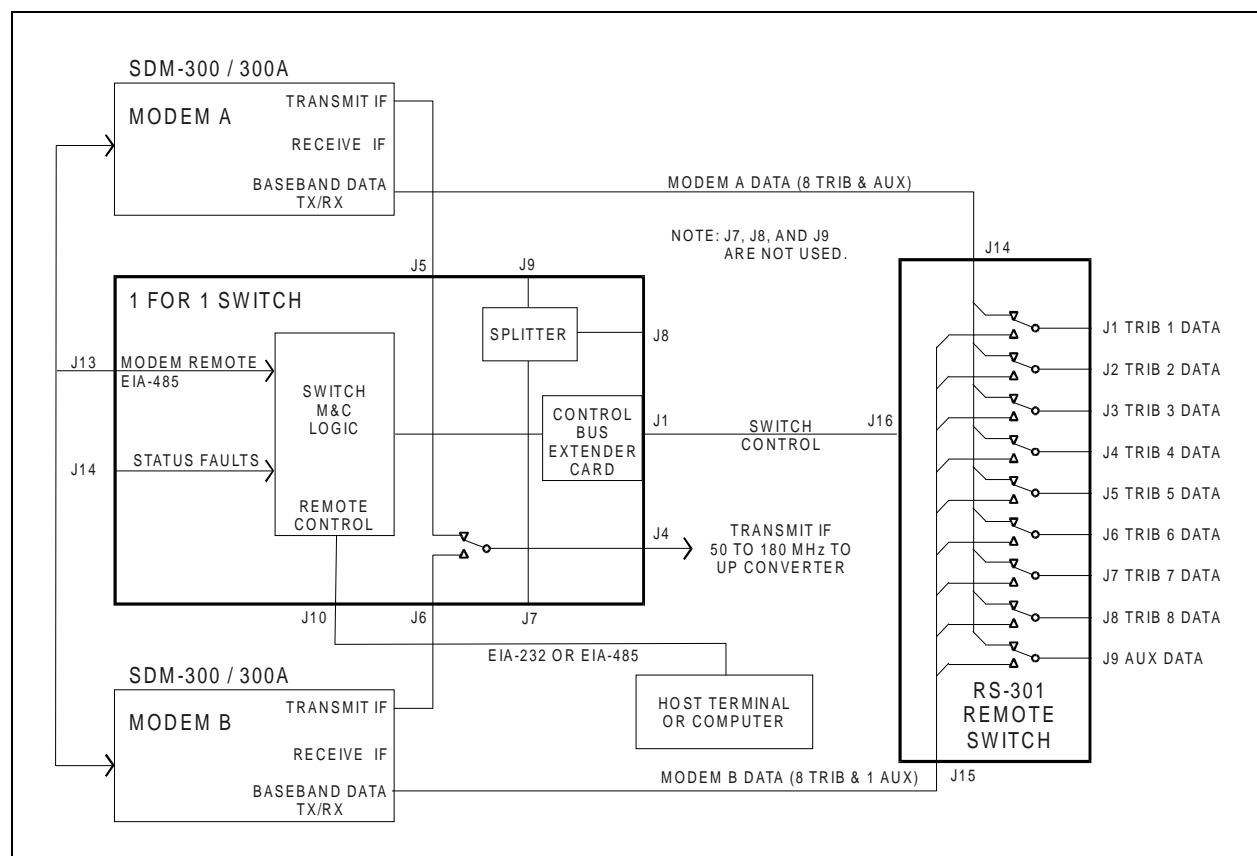

Figure 1-3. System Block Diagram (With RS-301 Option)

1.1.3 Board List

The following boards, listed in Table 1-1, can be installed in the SMS-301, depending on the configuration.

Table 1-1. Board List

Board Type	Drawing #
M&C, 75Ω	PL/5950-1
M&C, 50Ω	PL/5950-2
IBS, IDR, ASYNC, D&I, 50-pin Data, I/O (J1, J2, J3)	PL/5951
EIA-422/-449, G.703, V.35, 37-pin Data I/O (J1, J2, J3)	PL/5952
LVDS-DVB TX, 37-pin Interface	PL/6201-1
EIA-422/DVB TX, 37-pin Interface	PL/6201-2
EIA-232/-422/-530, V.35, G.703 25-pin Data, I/O (J1, J2, J3)	PL/6026
100-Pin Interface (RS-301 only)	PL/6592 PL/6627

1.2 Front Panel

The front panel of the chassis is a local user interface used for control and status monitoring of the switching system. This local user interface consists of the following:

- Keypad
- Backlit LED display
- LED status indicators (Table 1-2)

Table 1-2. LED Status Indictors

Function	Color
Demodulator A On-Line	Green
Demodulator B On-Line	Green
Modulator A On-Line	Green
Modulator B On-Line	Green
Transmit Fault	Red
Receive Fault	Red
System Fault	Red
Stored Fault	Yellow
Power Supply 1	Green
Power Supply 2	Green
Auto Mode	Green
Manual Mode	Yellow

1.3 Specifications

Refer to Table 1-3 for the 1:1 switch specifications.

Table 1-3. 1:1 Switch Specifications

Data Interface Switch: Modem A, I/O Modem B, I/O Common, I/O	Connector type: 25-pin D-sub, 37-pin D-sub 50-pin D-sub 100-pin D-sub
Control Bus Extender Card	Connector Type: 37-pin D-sub (Remote Switch)
IF Uplink Switch:	Connector type: BNC Impedance: 75Ω (50Ω optional) Return loss: ≥ 18 dB Switched input to output loss: < 1.5 dB Frequency response: 50 to 180 MHz IF input to input isolation: > 60 dB
IF Downlink Splitter:	Connector type: BNC Impedance: 75Ω (50Ω optional) Return loss: ≥ 18 dB Splitter loss, input to outputs: < 4.0 dB Output balance: ± 0.5 dB Frequency response: 50 to 180 MHz
Local User Interface	Front Panel: <ul style="list-style-type: none"> Keypad: 6 button (enter, clear, left, right, up, down arrows) Display: backlit LCD, 2 lines by 16 characters
Front Panel Status LEDs	Operational mode: <ul style="list-style-type: none"> Manual (Yellow) Automatic (Green) Switch faults: <ul style="list-style-type: none"> TX (Red) RX (Red) System (Red) Stored (Yellow) On-line Status: <ul style="list-style-type: none"> Modulator A (Green) Modulator B (Green) Demodulator A (Green) Demodulator B (Green)
On-line/Fault Status Modulator On-line Demodulator On-line Switch Fault Controller Fault Spare	Rear panel, 15-pin D-sub female Form C relay Form C relay Form C relay Form C relay Form C relay
Remote Control	Interface type: EIA-485/EIA-232 (local selectable) Connector: 9-pin D-sub Protocol: Addressable (see remote control protocol)

Table 1-3. 1:1 Switch Specifications (Continued)

Parameters Controlled/Monitored	Operation mode: Automatic or manual Switching mode: Independent or dependent mod/demod Modulator on-line delay Demodulator on-line delay Modem on-line: A or B (dependent mode) Modulator on-line: A or B (independent mode) Demodulator on-line: A or B (independent mode) Remote configuration (local only): EIA-232 or EIA-485, address, baud, parity, bits per word Remote mode (Switch) Clear stored faults Current faults Stored faults Switch status Firmware Time/date Equipment type Store/recall multiple switch configurations Remote access to modulator/demodulator status Modem configuration copy to opposite modem
Configuration Retention	Will maintain configuration for at least one year without prime power
Switch to Modem Communications	Interface type: EIA-485 (2-wire) Connector: 9-pin D-sub Protocol: Addressable (see remote control protocol, Appendix A)
Prime Power	85 to 264 VAC, 47 to 63 Hz, 30W (redundant inputs) <i>(Optional)</i> 42 to 56 VDC, 40W (redundant inputs)
Size	19 W x 15.2 D x 1.75 H inches (1 RU) (48.3 x 39 x 4.4 cm)
Weight	< 9 lbs (4 kg)
Operating Temperature	0° to 50° C (32° to 122° F)
Humidity	< 95%, non-condensing
EMI	CE Mark Certification

This page is intentionally left blank.

2 Chapter 2. INSTALLATION

This chapter provides installation information for the 1:1 switch, including unpacking, inspecting the parts, and external connections.

2.1 Unpacking

The 1:1 switch and manual are packaged in pre-formed, reusable cardboard cartons containing foam spacing for maximum shipping protection. To remove the 1:1 switch, proceed as follows:



Do not use any cutting tool that will extend greater than 1-inch into the container and cause damage to the 1:1 switch.

1. Cut the tape at the top of the carton where it is indicated OPEN THIS END.
2. Lift out the cardboard/foam spacer covering the 1:1 switch.
3. Remove the 1:1 switch, manual, and power cords from the carton.
4. Save the packing material for reshipment either back to the factory or to another location.
5. Inspect the equipment for any possible damage incurred during shipment.
6. Check the equipment against the packing list to ensure that the shipment is complete.
7. Refer to Section 2.2 for further system installation instructions.

2.2 System Installation

System installation instructions are dependent on whether or not the 1:1 switch is used with the RS-301 Remote Switch option.

- For all switch configurations where the Data I/O is switched internally to the 1:1 switch, refer to Appendix B for standard configuration installation. This configuration is used with the SDM-300/-300A Satellite Modems with 25-pin, 34-pin, 37-pin, and 50-pin Data I/O interfaces.
- When the RS-301 Remote Switch option is used and the Data I/O is switched in a separate unit, refer to Appendix B for installation with RS –301 switch installed. This configuration is used with the SDM-300/-300A Satellite Modem with a 100-pin Data I/O (8-channel Mux).

Note: Refer to Appendix C for SDM-2020 cabling instructions to the switch.

2.3 External Connections

Connections between the 1:1 switch and other equipment are performed through the rear panel connectors. These connectors vary depending on whether the Remote Switch (RS-301) is used.

- Refer to Table 2-1 for the connector list when the Data I/O is switched internal to the 1:1 switch.
- When the 1:1 switch is used with the Remote Switch (RS-301) option, refer to Table 2-2.

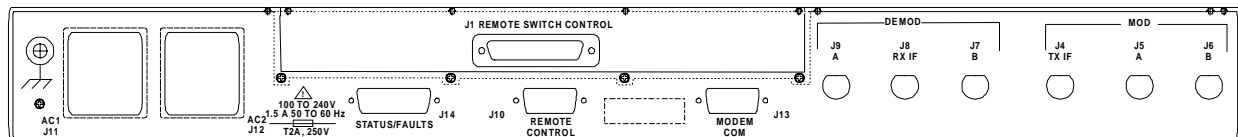

Rear Panel (Standard Configuration)

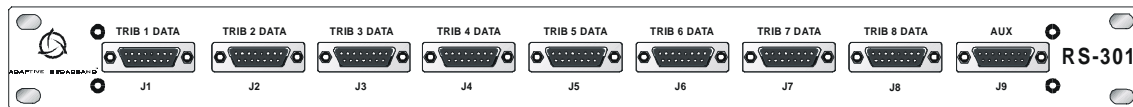

Rear Panel (With RS-301 Option)

Figure 2-1. SMS-301 Rear Panel Configurations

Table 2-1. Rear Panel Connectors (Standard Configuration)

Name	Ref Des	Connector Type	Function
DATA COM	J1	50/37/25-pin D	Common Data Interface
DATA A	J2	50/37/25-pin D	Modem A Data Interface
DATA B	J3	50/37/25-pin D	Modem B Data Interface
TX IF COM	J4	BNC	Common TX IF Output
TX IF A	J5	BNC	Modem A TX IF Input
TX IF B	J6	BNC	Modem B TX IF Input
RX IF B	J7	BNC	Modem B RX IF Output
RX IF COM	J8	BNC	Common RX IF Input
RX IF A	J9	BNC	Modem A RX IF Output
REMOTE CONTROL	J10	9-pin D	Remote Command Interface
AC POWER	J11/J12	IEC	AC Power Input
SW/MODEM COMM	J13	9-pin D	Modem A/B Remote
STATUS/FAULTS	J14	15-pin D	Switch Status (Form C relay)
GND	GND	#10-32 stud	Ground

Table 2-2. Rear Panel Connectors (With RS-301 Option)

Name	Ref Des	Connector Type	Function
REMOTE SWITCH CONTROL	J1	37-pin D	RS-301 Control Signals, Power, and Ground
TX IF COM	J4	BNC	Common TX IF Output
TX IF A	J5	BNC	Modem A TX IF Input
TX IF B	J6	BNC	Modem B TX IF Input
RX IF B	J7	BNC	Modem B RX IF Output
RX IF COM	J8	BNC	Common RX IF Input
RX IF A	J9	BNC	Modem A RX IF Output
REMOTE CONTROL	J10	9-pin D	Remote Command Interface
AC POWER	J11/J12	IEC	AC Power Input
DC POWER (<i>Optional</i>)	J11/J12	Terminal Block	DC Power Input
SW/MODEM COMM	J13	9-pin D	Modem A/B Remote
STATUS/FAULTS	J14	15-pin D	Switch Status (form C relay)
GND	GND	#10-32 stud	Ground

Note: The use of each connector is described in the following paragraphs.

2.3.1 Remote Switch Control (J1) (RS-301 Option)

For applications using the Remote Switch (RS-301) option, the connector type is a 37-pin D subminiature. Refer to Table 2-3 for the 37-pin connector pin assignments.

Table 2-3. Switch Control Interface Signals

Pin No.	Name	Function
1	SCL	Serial Clock
20	SDA	Serial Data
2	Spare 11	No Connection
21	Spare 10	No Connection
3	Spare 9	No Connection
22	Spare 8	No Connection
4	Spare 7	No Connection
23	Spare 6	No Connection
5	Spare 5	No Connection
24	Spare 4	No Connection
6	Spare 3	No Connection
25	Spare 2	No Connection
7	Spare 1	No Connection
26	DMDONL	Demod Online
8	MODONL	Mod Online
27	/B_DF	Modem B Demod Fault
9	/A_DF	Modem A Demod Fault
28	/B_MF	Modem B Mod Fault
10	/A_MF	Modem A Mod Fault
29	ID_5	Interface Board ID
11	ID_4	Interface Board ID
30	ID_3	Interface Board ID
12	ID_2	Interface Board ID
31	ID_1	Interface Board ID
13	GND	Ground
32	GND	Ground
14	GND	Ground
33	GND	Ground
15	GND	Ground
34	-12V	-12VDC
16	-12V	-12VDC
35	+12V	+12VDC
17	+12V	+12VDC
36	+5V	+5VDC
18	+5V	+5VDC
37	+5V	+5VDC
19	+5V	+5VDC

2.3.2 Data I/O Connections

The 1:1 switch data interface is dependent upon the installed switchboard. These are described in the following sections.

2.3.2.1 Data I/O Connector (J1, J2, J3), 50-Pin (PL/5951)

Note: For ASYNC, IBS, IDR, and D&I applications.

In order to maintain compatibility with various Comtech EFData breakout panels, the 50-pin D subminiature connector has the assignments shown in Table 2-4, depending upon the current operating mode.

Table 2-4. Data I/O Connector, 50-Pin

50-Pin D Connector				
Pin #	IDR	IBS	Async	D&I
34	G.703 SDA In	G.703 SDA In	G.703 SDA In	G.703 SDA In
18	G.703 SDB In	G.703 SDB In	G.703 SDB In	G.703 SDB In
36	G.703 RDA Out	G.703 RDA Out	G.703 RDA Out	G.703 RDA Out
20	G.703 RDB Out	G.703 RDB Out	G.703 RDB Out	G.703 RDB Out
35	EIA-422 ExtClkA In	V.35/EIA-422 EXCA In	V.35/EIA-422 EXCA In	EIA-422 EXCA In
19	EIA-422 ExtClkB In	V.35/EIA-422 EXCB In	V.35/EIA-422 EXCB In	EIA-422 EXCB In
37	EIA-422 8k TXDA In	V.35/EIA-422 SD-A In	V.35/EIA-422 SD-A In	G.703 DDO-A Out
38	EIA-422 8k TXDB In	V.35/EIA-422 SD-B In	V.35/EIA-422 SD-B In	G.703 DDO-B Out
21	EIA-422 8k TCkA Out	V.35/EIA-422 ST-A Out	V.35/EIA-422 ST-A Out	
22	EIA-422 8k TCkB Out	V.35/EIA-422 ST-B Out	V.35/EIA-422 ST-B Out	
4	EIA-422 TXOctA In		ESC TXDB In (EIA-485 only)	
5	EIA-422 TXOctB In	ESC TXDA In (EIA-232 only)	ESC TXDA In (EIA-485 & 232)	ESC TXD In (EIA-232 only)
39	EIA-422 8k RXDA Out	V.35/EIA-422 RD-A Out	V.35/EIA-422 RD-A Out	G.703 IDI-A In
40	EIA-422 8k RXDB Out	V.35/EIA-422 RD-B Out	V.35/EIA-422 RD-B Out	G.703 IDI-B In
23	EIA-422 8k RCkA Out	V.35/EIA-422 RT-A Out	V.35/EIA-422 RT-A Out	G.703 IDI-B In
24	EIA-422 8k RCkB Out	V.35/EIA-422 RT-B Out	V.35/EIA-422 RT-B Out	
6	EIA-422 RXOctA Out		ESC RXDB Out (EIA-485 only)	
7	EIA-422 RXOctB Out	ESC RXDA Out (EIA-232 only)	ESC RXDA Out (EIA-485 & 232)	ESC RXD Out (EIA-232)
45	Aud1-A In (or 64SDA)	V.35/EIA-422 RTS-A	V.35/EIA-422 RTS-A	
29	Aud1-B In (or 64SDB)	V.35/EIA-422 RTS-B	V.35/EIA-422 RTS-B	
44	BWO4_NO	SECONDARY_NO		SECONDARY_NO
12	BWAI 1	V.35/EIA-422 SCTE/TT A	V.35/EIA-422 SCTE/TT A	
13	BWAI 2	V.35/EIA-422 SCTE/TT B	V.35/EIA-422 SCTE/TT B	
14	BWAI 3	EIA-422 TX Oct A		
15	BWAI 4	EIA-422 TX Oct B		
17	Def Maint Alarm			
16	Demod Fault C			
50	Demod Fault NO			
3	AGC Out	AGC Out	AGC Out	AGC Out
49	MF (Open Collector)	MF (Open Collector)	MF (Open Collector)	MF (Open Collector)
33	DF (Open Collector)	DF (Open Collector)	DF (Open Collector)	DF (Open Collector)
1, 2	Ground			

2.3.2.2 Data I/O Connector (J1, J2, J3), 37-Pin (PL/5952)

Note: For EIA-422/-449, V.35, and G.703 applications.

The 37-pin D subminiature connector pin assignments are shown in Table 2-5.

Table 2-5. Data I/O Connectors, 37-Pin

Pin #	EIA-422/-449	V.35	G.703	Signal Function
1	SG	SG	SG	Signal Ground
3	MF	MF	MF	MOD Fault
4	SD-A	SD-A	SD-A	Send Data
22	SD-B	SD-B	SD-B	
5	ST-A	ST-A		Send Timing
23	ST-B	ST-B		
6	RD-A	RD-A	RD-A	Receive Data
24	RD-B	RD-B	RD-B	
7	RS-A	RS-A		Request to Send
25	RS-B	RS-B		
8	RT-A	RT-A		Receiver Timing
26	RT-B	RT-B		
9	CS-A	CS-A		Clear to Send
27	CS-B	CS-B		
11	DM-A	DM-A		Data Mode
29	DM-B	DM-B		
13	RR-A	RR-A		Receiver Ready
31	RR-B	RR-B		
17	TT-A	TT-A		Terminal Timing
35	TT-B	TT-B		
16	MC-A	MC-A	MC-A	Master Clock (Input)
34	MC-B	MC-B	MC-B	
19	SG	SG	SG	Signal Ground
20	SG	SG	SG	Signal Ground
21	DF	DF	DF	DEMOM Fault
37	SG	SG	SG	Signal Ground

The following shows the jumper configurations for EIA-422/449, V.35, and G.703.

EIA-422/449/V.35	G.703
JP2	JP1
JP3	JP6
JP4	JP7
JP5	JP6
	JP9

2.3.2.3 Data I/O Connector (J1, J2, J3), 25-Pin (PL/6026)

Note: For EIA-422/-530, EIA-232, V.35, or G.703 applications,

The 25-pin D subminiature connector has the pin assignments shown in Table 2-6.

Table 2-6. Connector Assignments, 25-Pin

Pin #	EIA-422/-530	EIA-232	V.35	G.703	Signal Function
3	RD-A	RXD	RD-A	RD-A	Receive Data
16	RD+B		RD+B	RD+B	
2	SD-A	TXD	SD-A	SD-A	Send Data
14	SD+B		SD+B	SD+B	
24	TT-A	TXC	SCTE--A		Terminal Timing
11	TT+B		SCTE+B		
15	ST-A	ST	SCT-A		Send Timing
12	ST+B		SCT+B		
17	RT-A	RXC	SCR-A		Receiver Timing
9	RT-B		SCR-B		
4	RS-A	RTS	RTS		Request to Send
19	RS+B				
5	CS-A	CTS	CTS		Clear to Send
13	CS+B				
8	RR-A	DCD	RLSD		Receiver Ready
10	RR+B				
6	DM-A	DSR	DSR		Data Mode
22	DM+B				
20	MC-A	MC	MC-A	MC-A	Master Clock (input)
23	MC+B		MC+B	MC+B	
18	LL	LL	LL		
21	DF	DF	DF	DF	Demod Fault
25	MF	MF	MF	MF	Mod Fault
7	SIGGND	SIGGND	SIGGND	SIGGND	Signal Ground
1	SHLD	SHLD	SHLD	SHLD	

The following shows the jumper configurations for EIA-422/530.

EIA-422/-530	V.35	EIA-232	G.703
J6	J6	J19	J5
J7	J7	J23	J10
J8	J8	J24	J11
J9	J9	J25	J12
J14	J14	J27	J13
J15	J15	J28	J14
J17	J16	J29	J18
J18	J18	J30	J20
J20	J20	J17	J21
J21	J21		J22
J22	J22		J26
J26	J26		

2.3.2.4 Data I/O (J1, J2, J3) 37-Pin (PL/6201-1)

Note: For EIA-422/LVDS DVB (Serial or Parallel) Interface applications.

The 37-pin D subminiature connector has the pin assignments shown in Table 2-7.

Table 2-7. Connector Assignments, 37-Pin

Pin #	Signal Function/Name	Comment
1	Signal GND	Mod/Demod
2	REF CLK/GND B	REF CLK
3	MF	Mod Fault
4	NC	No Connection
5	NC	No Connection
6	D0B	Data
7	D1 B	Data
8	D2 B	Data
9	D3 B	Data
10	D4 B	Data
11	D5 B	Data
12	D6 B	Data
13	D7 B	Data
14	Valid B	Valid
15	SYNC B	SYNC
16	NC	No Connection
17	NC	No Connection
18	NC	No Connection
19	CLK A	Clock
20	NC	No Connection
21	REF CLK/GND A	REF CLK
22	DF	Demod Fault
23	NC	No Connection
24	NC	No Connection
25	D0 A	Data
26	D1 A	Data
27	D2 A	Data
28	D3 A	Data
29	D4 A	Data
30	D5 A	Data
31	D6 A	Data
32	D7 A	Data
33	Valid A	Valid
34	SYNC A	SYNC
35	NC	No Connection
36	NC	No Connection
37	CLK B	Clock

2.3.2.5 Data I/O Connector (J1, J2, J3) 37-Pin (PL/6201-2)

Note: For EIA-422 Serial Interface applications.

The 37-pin D subminiature connector has the pin assignments shown in Table 2-8.

Table 2-8. Connector Assignments, 37-Pin

Pin #	Signal Function/Name	Comment
1	Signal GND	Mod/Demod
2	Send Timing (ST-B)	Modulator
3	Modulator Fault (MF)	Modulator
4	NC	NC
5	NC	NC
6	NC	NC
7	NC	NC
8	NC	NC
9	Clear To Send (CS-A)	Modulator
10	NC	NC
11	NC	NC
12	NC	NC
13	Send Data (SD-B)	Modulator
14	Request To Send (RS-B)	Modulator
15	NC	NC
16	NC	NC
17	NC	NC
18	NC	NC
19	Terminal Timing (TTA)	Modulator
20	NC	NC
21	Send Timing (TT-A)	Modulator
22	NC	NC
23	NC	NC
24	NC	NC
25	NC	NC
26	NC	NC
27	Clear To Send (CS-B)	Modulator
28	NC	NC
29	NC	NC
30	NC	NC
31	NC	NC
32	Send Data (SD-A)	Modulator
33	Request To Send (RS-A)	Modulator
34	NC	NC
35	NC	NC
36	NC	NC
37	Terminal Timing (TT-B)	Modulator

2.3.2.6 100 Pin interface (RS-301 Option) (PL/6542/PL/6627)

The 100-pin connector pin assignments is shown in Table 2-9.

Table 2-9. Data I/O Connector, 100-Pin

MUX Data 100-Pin Rear Panel Connector					
Pin #	Circuit	Description	Pin #	Circuit	Description
1	–	N/A	51	GND	GROUND
2	–	N/A	52	TC232 5	EIA-232, TX CLK , TRIB5
3	–	N/A	53	TD232 5	EIA-232, TX DAT, TRIB5
4	–	N/A	54	CTS232 5	EIA-232, CTS, TRIB5
5	GND	GROUND	55	TD422B 5	EIA-422, TX DATB (+), TRIB5
6	GND	GROUND	56	TD422A 5	EIA-422, TX DATA (-), TRIB5
7	DF	DEMOD FAULT	57	TC422B 5	EIA-422, TX CLKB (+), TRIB5
8	MF	MOD FAULT	58	TC422A 5	EIA-422, TX CLKA (-), TRIB5
9	GND	GROUND	59	CTS422B 5	EIA-422, CTSB (+), TRIB5
10	RT+B	RECEIVE TIMING B (+)	60	CTS422A 5	EIA-422, CTSB (-), TRIB5
11	RT-A	RECEIVE TIMING A (-)	61	GND	GROUND
12	GND	GROUND	62	TC232 4	EIA-232, TX CLK , TRIB4
13	RD+B	RECEIVE DATA B (+)	63	TD232 4	EIA-232, TX DAT, TRIB4
14	RD-A	RECEIVE DATA A (-)	64	CTS232 4	EIA-232, CTS, TRIB4
15	GND	GROUND	65	TD422B 4	EIA-422, TX DATB (+), TRIB4
16	RR+B	RECEIVER READY B (+)	66	TD422A 4	EIA-422, TX DATA (-), TRIB4
17	RR-A	RECEIVER READY A (-)	67	TC422B 4	EIA-422, TX CLKB (+), TRIB4
18	GND	GROUND	68	TC422A 4	EIA-422, TX CLKA (-), TRIB4
19	MCB	MASTER CLOCK B (+)	69	CTS422B4	EIA-422, CTSB (+), TRIB4
20	MCA	MASTER CLOCK A (-)	70	CTS422A4	EIA-422, CTSB (-), TRIB4
21	GND	GROUND	71	GND	GROUND
22	TC232 8	EIA-232, TX CLK , TRIB8	72	TC232 3	EIA-232, TX CLK , TRIB3
23	TD232 8	EIA-232, TX DAT, TRIB8	73	TD232 3	EIA-232, TX DAT, TRIB3
24	CTS232 8	EIA-232, CTS, TRIB8	74	CTS232 3	EIA-232, CTS, TRIB3
25	TD422B 8	EIA-422, TX DATB (+), TRIB8	75	TD422B 3	EIA-422, TX DATB (+), TRIB3
26	TD422A 8	EIA-422, TX DATA (-), TRIB8	76	TD422A 3	EIA-422, TX DATA (-), TRIB3
27	TC422B 8	EIA-422, TX CLKB (+), TRIB8	77	TC422B 3	EIA-422, TX CLKB (+), TRIB3
28	TC422A 8	EIA-422, TX CLKA (-), TRIB8	78	TC422A 3	EIA-422, TX CLKA (-), TRIB3
29	CTS422B8	EIA-422, CTSB (+), TRIB8	79	CTS422A3	EIA-422, CTSB (+), TRIB3
30	CTS422A8	EIA-422, CTSB (-), TRIB8	80	CTS422A3	EIA-422, CTSB (-), TRIB3
31	GND	GROUND	81	GND	GROUND
32	TC232 7	EIA-232, TX CLK , TRIB7	82	TC232 2	EIA-232, TX CLK , TRIB2
33	TD232 7	EIA-232, TX DAT, TRIB7	83	TD232 2	EIA-232, TX DAT, TRIB2
34	CTS232 7	EIA-232, CTS, TRIB7	84	CTS232 2	EIA-232, CTS, TRIB2
35	TD422B 7	EIA-422, TX DATB (+), TRIB7	85	TD422B 2	EIA-422, TX DATB (+), TRIB2
36	TD422A 7	EIA-422, TX DATA (-), TRIB7	86	TD422A 2	EIA-422, TX DATA (-), TRIB2
37	TC422B 7	EIA-422, TX CLKB (+), TRIB7	87	TC422B 2	EIA-422, TX CLKB (+), TRIB2
38	TC422A 7	EIA-422, TX CLKA (-), TRIB7	88	TC422A 2	EIA-422, TX CLKA (-), TRIB2
39	CTS422B7	EIA-422, CTSB (+), TRIB7	89	CTS422B2	EIA-422, CTSB (+), TRIB2
40	CTS422A7	EIA-422, CTSB (-), TRIB7	90	CTS422A2	EIA-422, CTSB (-), TRIB2
41	GND	GROUND	91	GND	GROUND
42	TC232 6	EIA-232, TX CLK , TRIB6	92	TC232 1	EIA-232, TX CLK , TRIB1
43	TD232 6	EIA-232, TX DAT, TRIB6	93	TD232 1	EIA-232, TX DAT, TRIB1
44	CTS232 6	EIA-232, CTS, TRIB6	94	CTS232 1	EIA-232, CTS, TRIB1
45	TD422B 6	EIA-422, TX DATB (+), TRIB6	95	TD422B 1	EIA-422, TX DATB (+), TRIB1
46	TD422A 6	EIA-422, TX DATA (-), TRIB6	96	TD422A 1	EIA-422, TX DATA (-), TRIB1
47	TC422B 6	EIA-422, TX CLKB (+), TRIB6	97	TC422B 1	EIA-422, TX CLKB (+), TRIB1
48	TC422A 6	EIA-422, TX CLKA (-), TRIB6	98	TC422A 1	EIA-422, TX CLKA (-), TRIB1
49	CTS422B6	EIA-422, CTSB (+), TRIB6	99	CTS422B1	EIA-422, CTSB (+), TRIB1
50	CTS422A6	EIA-422, CTSB (-), TRIB6	100	CTS422A1	EIA-422, CTSB (-), TRIB1

2.3.3 Transmit IF Connectors (J4, J5, J6)

The transmit IF switch connectors are as follows:

- The TX IF output of the prime modem connects to TX IF A.
- The TX IF output of the backup modem connects to TX IF B.
- TX IF COMM is the transmit IF output connector and connects to the uplink IF equipment. The TX IF output of the on-line modem will be available at this connector.
- The characteristic impedance of these BNC connectors is 75Ω (50Ω optional).
- If the backup or prime modem is disconnected for any reason, place a 75Ω (50Ω optional) termination on the unused connector for a 75Ω (50Ω optional) system, respectively.

2.3.4 RX IF Connectors (J7, J8, J9)

The Receive IF splitter connectors are as follows:

- The RX IF of the prime modem connects to RX IF A and the RX IF of the backup modem connects to RX IF B.
- RX IF COM connects to customer-furnished equipment.
- The characteristic impedance of these BNC connectors is 75Ω (50Ω optional).
- There will be less than 4 dB loss between the common input and the A or B output connectors.
- If the backup or prime modem is disconnected for any reason, place a 75Ω (50Ω optional) termination on the unused connector for a 75Ω (50Ω optional) system, respectively.

2.3.5 Remote Control Interface Connector (J10)

The remote control interface (J10) connector is described in the following listings. Pinout data is included in Table 2-10.

Connector type	9-pin D subminiature, female
Signal type	EIA-232 or EIA-485, user-selectable

Interface connector type:

- EIA-485 (2-wire or 4-wire)
- EIA-232 (Optional)
- Baud rate range 150 to 19.2 kbit/s
- ASCII characters
- 11 bits per character (maximum):
 - ◆ 1 start bit
 - ◆ 7 information bits, 1 parity bit (odd/even) or 8 information bits, 0 parity bit, 1 stop bit
 - ◆ 2 stop bits

Table 2-10. Remote Control Interface Connector Pinout Data (J10)

EIA-485			EIA-232	
4-Wire		2-Wire		
Pin #	Name	Name	Pin #	Name
1	GND		1	
2			2	RD(RX)
3			3	TD (TX)
4	+TX	+TX/+RX	4	
5	-TX	-TX/-RX	5	GND
6			6	DSR
7			7	RTS
8	+RX	+RX/+TX	8	CTS
9	-RX	-RX/-TX	9	

Notes: (For EIA-485 4-wire operation)

1. Pins 4 and 8 may be tied together.
2. Pins 5 and 9 may be tied together.

2.3.6 Prime Power

2.3.6.1 AC Power (J11 and J12)

Refer to Table 2-11 for AC prime power requirements.

Table 2-11. AC Power (J11 and J12)

Description	Requirements
AC power is supplied independently to each of the two power supplies by two standard detachable, non-locking, 3-prong power cords.	85 to 264 VAC
Maximum Power consumption	30W
Input Range	85 to 264 VAC
Changing Input Voltage	No reconfiguration is required.

2.3.6.2 DC Power (J11 and J12) (Optional)

Refer to Table 2-12 for DC prime power requirements.

Table 2-12. DC Prime Power (J11 and J12)

Description	Requirements
Input Range	42 to 56 VDC
Maximum Power Consumption	40W

2.3.7 Switch/Modem Communications Interface Connector (J13)

The switch/modem communications interface (J13) connector is described in the following listings and pinout data is included in Table 2-13.

Interface type:

- EIA-485 (2-wire)
- Baud rate range 9.6 or 19.2 kbit/s
- ASCII characters
- 11 bits per character:
 - ◆ 7 information bits
 - ◆ 2 stop bits
 - ◆ 1 parity (Even)
 - ◆ 1 start bit

Table 2-13. Switch/Modem Communications Interface Connector (J13)

Pinout	
Pin #	Name (2-Wire)
1	GND
2	
3	
4	+TX, +RX
5	-TX, -RX
6	
7	
8	+RX, +TX
9	-RX, -TX

2.3.8 Status/Fault (J14)

Refer to Table 2-14 for Status/Faults (J14) pinout assignments.

Connector-Type:	15-Pin D Subminiature, female Form C contact Rating 2A maximum @ 30 VDC, 0.6A @ 125 VAC
-----------------	--

Table 2-14. Status/Faults (J14) Pinout Assignments

Pinout		
Pin #	Name	Function
1	Spare COM	
2	Spare NO	
3	Spare NC	
4	CEQ COM	
5	CEQ NO	Common Equipment OK
6	CEQ NC	Common Equipment Faulted
7	MODONL COM	
8	MODONL NO	Mod B On-line Status
9	MODONL NC	Mod A On-line Status
10	SW COM	
11	SW NO	Switch OK
12	SW NC	Switch Faulted
13	DMDONL COM	
14	DMDONL NO	Demod B On-line Status
15	DMDONL NC	Demod A On-line Status

2.3.9 IF Connections: Transmit and Receive

The data is provided in the following listing:

Connector type	BNC 75Ω (50Ω Optional)
Return loss	≥ 18 dB from 50 to 180 MHz

2.3.10 Ground

A #10-32 stud is provided on the rear of the chassis for connecting a common chassis ground between all of the equipment.

3 Chapter 3. OPERATION

This chapter defines the controls and procedures for configuration and operation of the 1:1 switch.

Note: Familiarization with the front panel controls (Figure 3-1) and/or the related remote commands described in Appendix A is recommended by Comtech EFData.

3.1 Configuration

The configuration of the 1:1 switch may be performed from the front panel, or from a terminal or personal computer connected to the 1:1 switch remote port (J10). Each front panel menu screen, from which entries can be made or status displayed, has a corresponding remote command(s). Unlike the remote commands, the front panel display menus are designed to sequentially guide the operator through the configuration process.

Note: Refer to the menu tables presented in this chapter for specific configuration information.

Upon completion of the 1:1 switch installation, as described in Chapter 2, the prime modem attached to the 1:1 switch shall be programmed prior to the initial configuration of the switch.

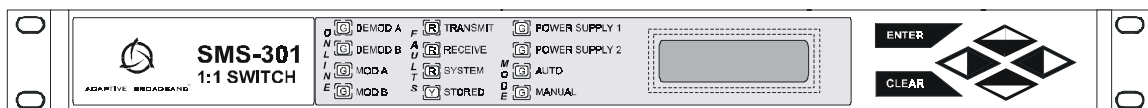

Figure 3-1. SMS-301 Front Panel View

3.2 Setup and Configuration

Table 3-1 details the default configuration parameters of the 1:1 switch. The 1:1 switch is returned to this default configuration by performing a hard reset, or upon failure/corruption of non-volatile memory.

Table 3-1. Default Configuration Parameters

Parameter	Condition
Operation Mode	Automatic
On-line Modem	A
On-line Mod	A
On-line Demod	A
Switch Mode	Independent
Modem Delay	0.0
Mod Delay	0.0
Demod Delay	0.0
Modulators	Active
Demodulators	Active
Time	12:00:00 AM
Date	7/04/76
Remote Baud Rate	9600 bit/s Even
Remote Address	10
Remote Type	EIA-485 (2-wire)
Display Contrast	Level 64
Automatic Verify	Disable
Modem A Address	1
Modem B Address	2
Modem Baud Rate	9600 bit/s

The following sections detail the minimum modifications necessary to set up a typical 1:1 redundant configuration. In the following setup descriptions, it is assumed Modem A connections are to the prime modem. While proper switch operation does not require Modem A to be the prime modem, it should be noted that upon loss of prime power to the 1:1 switch, Modem A is the default signal pass through path.

3.2.1 Utility System

Prior to configuration, it may be necessary to modify the following:

Display Contrast	Adjust for optimum viewing in local ambient lighting conditions.
Remote Options	If a remote is to be used, appropriate remote options can be verified or defined from the Utilities menu.
Modem Control Baud Rate	Select the highest common baud rate for the modems attached to the 1:1 switch.

3.2.2 Configuration

Upon completion of the installation, the 1:1 switch is ready for configuration to the specific application requirements.

Note: The normal operating mode is AUTOMATIC, which shall be changed to MANUAL when locally configuring the 1:1 switch.

3.2.2.1 Prime

To configure the 1:1 switch for operation with the prime modem, set the following:

Address	Enter a unique 3-digit decimal address for remote communications.
Mod/Demod	ON or OFF; Must be ON for consideration by the switch algorithm.
Switching Mode	Select INDEPENDENT or DEPENDENT RX/TX switching.

Note: INDEPENDENT mode switching can be used to switch the modulator and/or the demodulator. DEPENDENT mode switching always switches the modulator and demodulator.

3.2.2.2 Backup

To configure the 1:1 switch for operation with the backup modem, set the following:

Address	Enter a 3-digit decimal address for remote communications.
Mod/Demod	ON or OFF; Must be ON for consideration by the switch algorithm.
Delay	Enter the desired delay. If INDEPENDENT mode switching is selected, enter delay for Mod and Demod.
Verify	Enable or disable Automatic Verify. This can be used to signal configuration changes between modems.
Load	Use the Load Modem A→B option under the Utility Modem Control menu on the 1:1 switch to automatically configure the backup modem to the prime modem configuration.

Note: If the backup modem is not to be configured to match the prime modem, the programming of the backup modem shall be performed manually.

3.2.2.3 Operation Mode

Two modes of operation are available for the 1:1 switch:

AUTOMATIC	If the AUTOMATIC mode is selected, the 1:1 switch algorithm will perform backup operations as defined in the Configuration menus.
MANUAL	When the MANUAL mode is selected, the system provides a dedicated menu through which the operator may unconditionally assign backup RX and TX functions to replace the prime modem.

Note: The 1:1 switch shall be in AUTOMATIC mode to automatically replace the faulted prime.

The manual configuration may be used when Modem A parameters are to be different than Modem B. The 1:1 switch is then used as a master switch. Turn automatic verify off. (The automatic verify is located under the Utility Modem Control menu.)

3.3 Faults

Alerts to modem or 1:1 switch faults are provided in several ways:

- Indicators on the 1:1 switch control panel, with specific information available in the Faults/Alarms menu.
- On demand via the 1:1 switch remote port. Specifics for 1:1 switch and modem faults are available.
- Analog status/fault indication signals on the rear of the 1:1 switch (J14).

Note: Refer to Chapter 5 for troubleshooting switch faults, or the respective modem manual for modem faults.

3.4 Front Panel Keypad

The front panel keypad permits local operation of the 1:1 switch. The keypad consists of six keys (Figure 3-2).

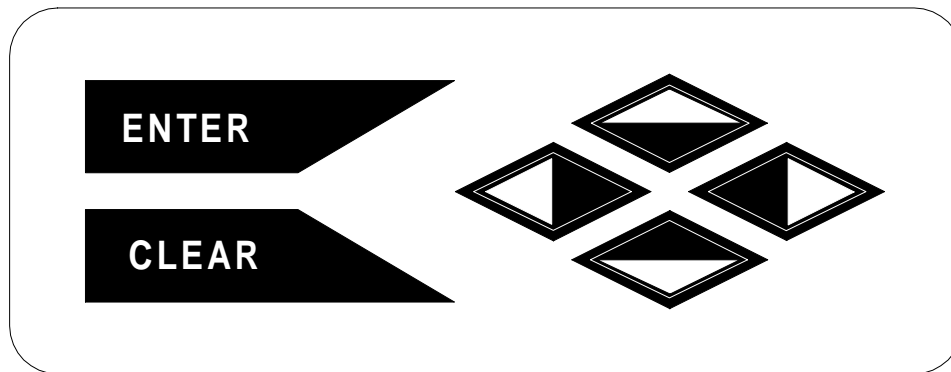

Figure 3-2. Keypad

Each key provides one or more logical functions. The keypad functions are defined in Table 3-2.

Table 3-2. Keypad Functions

ENTER	This key is used to select a displayed function or to execute a 1:1 switch configuration change.
CLEAR	This key is used to back out of a selection or to cancel a configuration change which has not been executed using [ENTER]. Pressing [CLEAR] generally returns the display to the previous selection.
[←] and [→]	These keys are used to move to the next selection or to move the cursor for certain functions.
[↑] and [↓]	These keys are used primarily to change configuration data (numbers) but are also used at times to move from one section to another.

The 1:1 switch responds by beeping whenever a key is pressed:

- A single beep indicates a valid entry and the appropriate action was taken.
- A double beep indicates an invalid entry, or a parameter is not available for operation.

3.5 Menu System

To access and execute all functions, refer to Figure 3-3 through Figure 3-12. Use the main menu in Figure 3-3 as a quick reference for accessing the 1:1 switch functions. For further configuration details, refer to Section 3.2.

When the 1:1 switch power is turned ON, the base level of the menu system displays the sign-on message:

- Line 1 of the sign-on message is the 1:1 switch model number and type.
- Line 2 is the version number of the firmware.

The main level of the menu system is Function Select. To access this level from the sign-on message, press the [←] or [→] keys. From the Function Select menu, select one of the functional categories:

- Configuration
- Monitor
- Faults/Alarms
- Stored Faults/Alarms
- Utility

Press [←] or [→] to move from one selection to another. When line 2 displays the desired function, select that level by pressing [ENTER]. After entering the appropriate functional level, press [←] or [→] to move to the desired function.

To view or change the configuration of the 1:1 switch, enter the Configuration level from the Function Select menu. Once in the Configuration menu, press [←] or [→] to scroll through the Configuration menu selection.

Press [ENTER] to select the desired Configuration menu option. To view the options for the selected configuration parameters, press [←] or [→]. To change a configuration parameter, press [ENTER] to begin the change process.

Press [↑] or [↓] to change the parameters. After the display represents the correct parameters, press [ENTER] to execute the change. This action initiates the necessary programming by the 1:1 switch.

To undo a parameter change prior to execution, press [CLEAR].

The following notes describe each configuration function in detail.

Notes:

1. Figure 3-3 through Figure 3-12 list the front panel menu window selections.
2. Menus or commands that are specific to certain 1:1 switch configurations are only accessible after selecting the appropriate 1:1 switch configuration. This prevents incompatible parameters from accidentally being selected.

3.5.1 Front Panel Menus

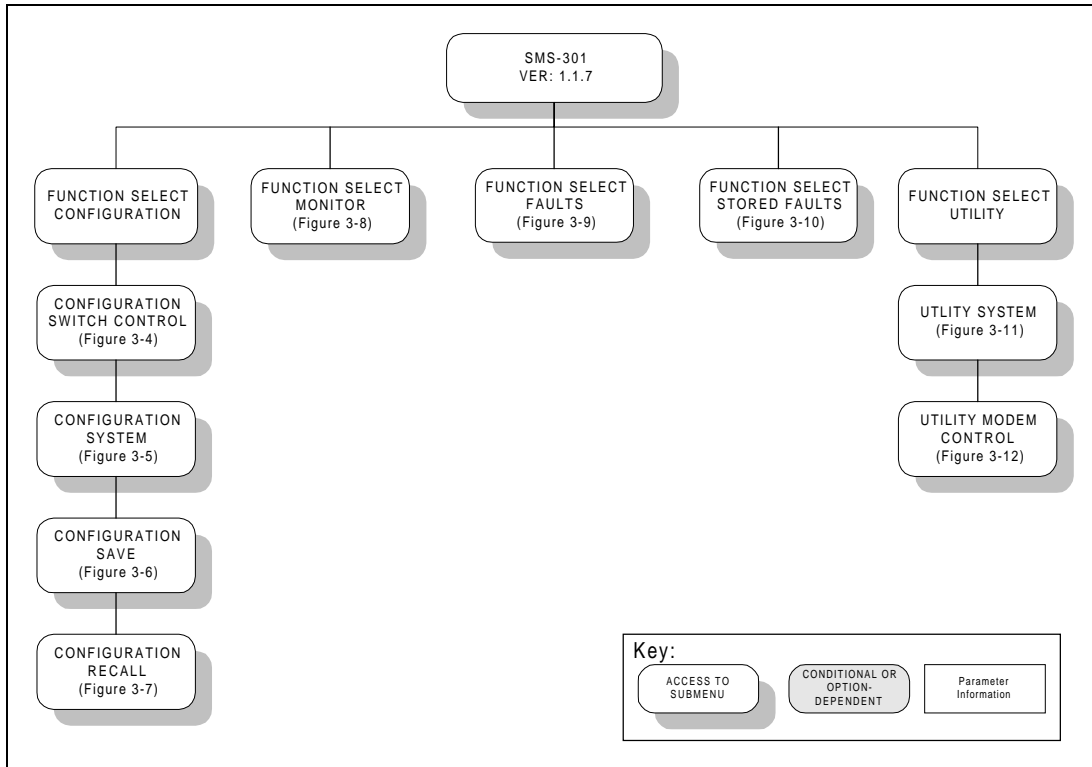

Figure 3-3. Main Menu

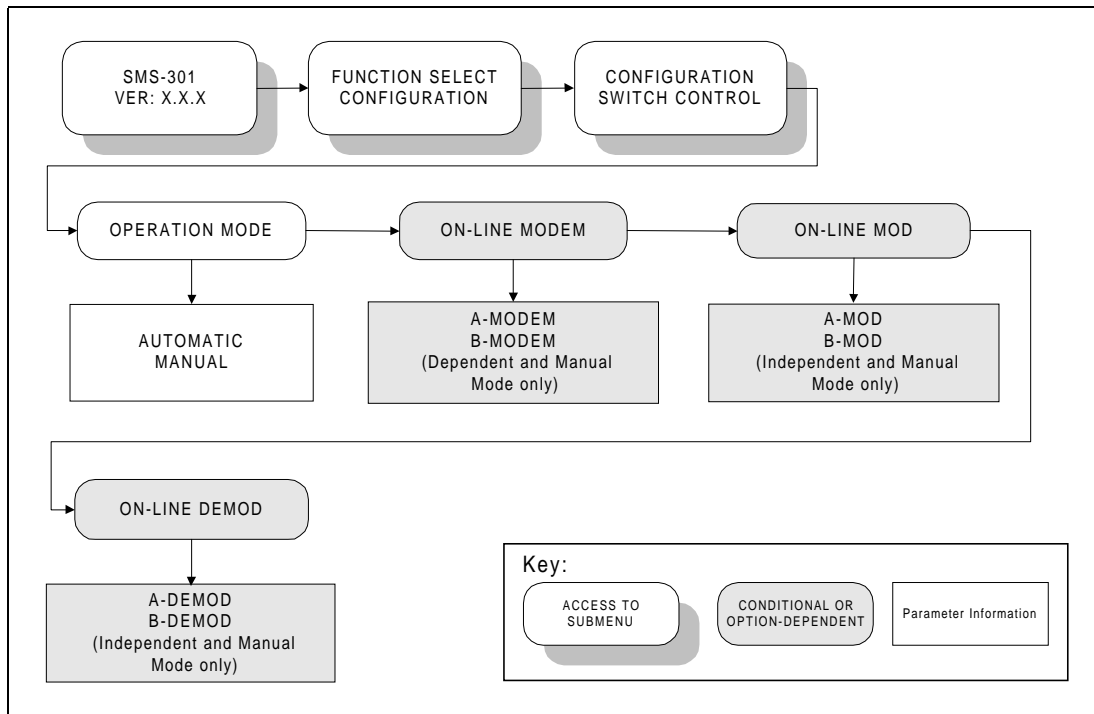

Figure 3-4. Configuration Switch Control Menu

3.5.1.1 Configuration Switch Control Menu

Refer to Figure 3-4.

OPERATION MODE	<p>Programs the 1:1 switch to AUTOMATIC or MANUAL mode.</p> <p>Upon entry, the current status of the 1:1 switch is displayed. Press [ENTER], then use any of the arrow keys to select. Press [ENTER] to execute the change, or [CLEAR] to abandon the change.</p> <p>Note: The AUTOMATIC mode is the normal operating mode. The MANUAL mode is required for most configuration changes.</p>
ON-LINE MODEM	<p>Select the prime or backup modem (A-MODEM or B-MODEM).</p> <p>Note: Ensure that the 1:1 switch is in MANUAL mode.</p> <p>Upon entry, the current status of the 1:1 switch is displayed. Press [ENTER], then use any of the arrow keys to select. Press [ENTER] to execute the change, or [CLEAR] to abandon the change.</p> <p>Note: This feature is available in the DEPENDENT and MANUAL mode only.</p>
ON-LINE MOD	<p>Select the prime or backup MODULATOR.</p> <p>Note: Ensure that the 1:1 switch is in MANUAL mode.</p> <p>Upon entry, the current status of the 1:1 switch is displayed. Press [ENTER], then use any of the arrow keys to select. Press [ENTER] to execute the change, or [CLEAR] to abandon the change.</p> <p>Note: This feature is available in the INDEPENDENT and MANUAL mode only.</p>
ON-LINE DEMOD	<p>In the ON-LINE DEMODULATOR, the operator can select a prime or backup demodulator.</p> <p>Note: Ensure 1:1 switch is in MANUAL mode.</p> <p>Upon entry, the current status of the 1:1 switch is displayed. Press [ENTER], then use any of the arrow keys to select. Press [ENTER] to execute the change, or [CLEAR] to abandon the change.</p> <p>Note: This feature is available in the INDEPENDENT and MANUAL mode only.</p>

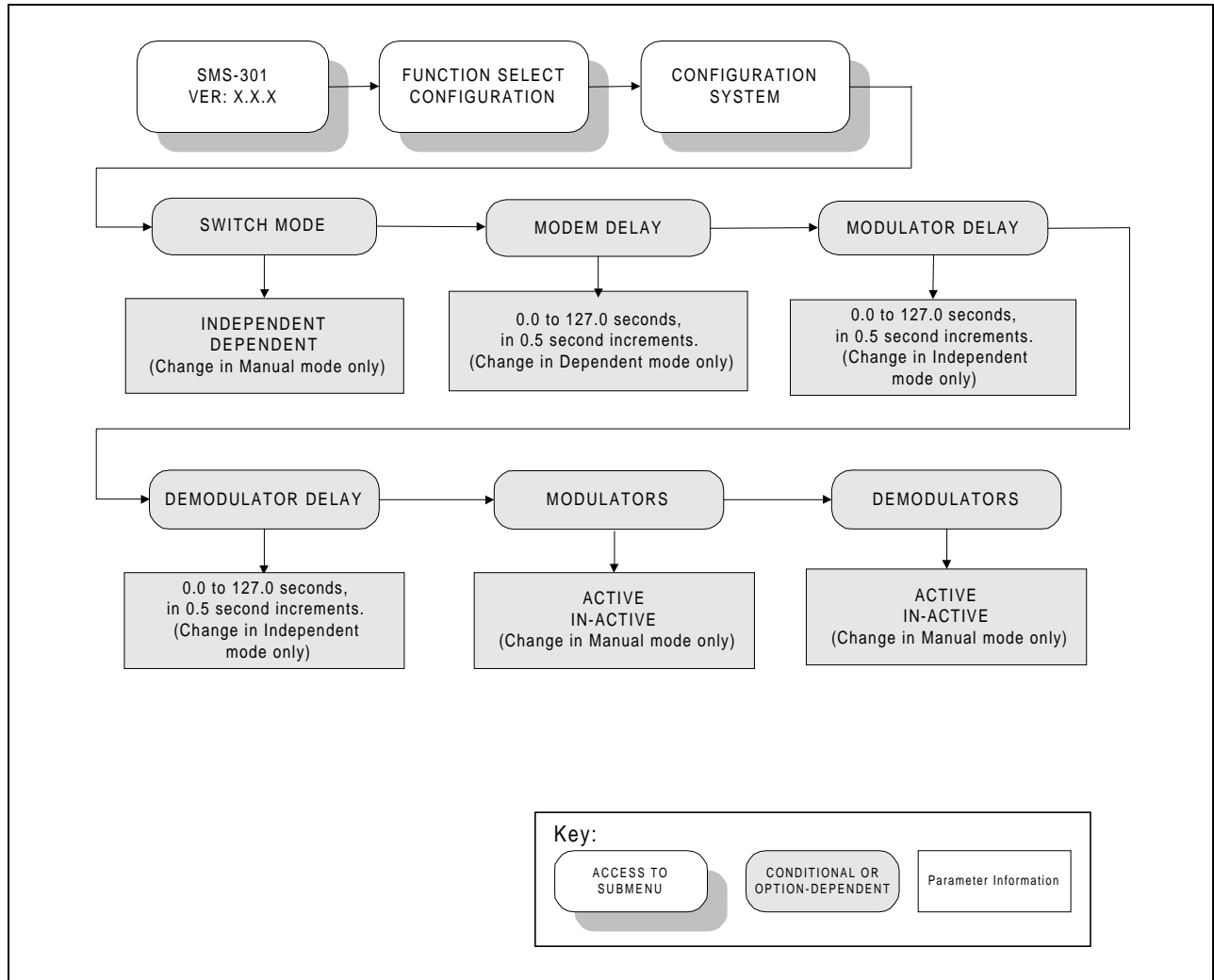

Figure 3-5. Configuration System Menu

3.5.1.2 Configuration System Menu

Refer to Figure 3-5 for the Configuration System.

SWITCH MODE	<p>Programs the 1:1 switch to INDEPENDENT or DEPENDENT mode.</p> <p>DEPENDENT— If a prime component (modulator or demodulator) faults, the prime system will go off-line. The backup system (modulator and demodulator) will come on-line.</p> <p>INDEPENDENT— If a prime component (modulator or demodulator) faults, the backup component (modulator or demodulator) will come on-line.</p> <p>Note: Ensure 1:1 switch is in MANUAL mode.</p> <p>Upon entry, the current status of the 1:1 switch is displayed. Press [ENTER], then use any of the arrow keys to select. Press [ENTER] to execute the change, or [CLEAR] to abandon the change.</p>
MODEM DELAY	<p>Programs a switching delay of 0 to 127 seconds, in 0.5 second increments.</p> <p>Note: Ensure 1:1 switch is in DEPENDENT mode</p> <p>Upon entry, the current status of the 1:1 switch is displayed. Press [←] or [→] to move the flashing cursor. Press [↑] or [↓] to increase or decrease the numbers. Press [ENTER] to execute the change, or [CLEAR] to abandon the change.</p>
MODULATOR DELAY	<p>Programs a switching delay of 0 to 127 seconds, in 0.5 second increments.</p> <p>Note: Ensure 1:1 switch is in INDEPENDENT mode</p> <p>Upon entry, the current status of the 1:1 switch is displayed. Press [←] or [→] to move the flashing cursor. Press [↑] or [↓] to increase or decrease the numbers. Press [ENTER] to execute the change, or [CLEAR] to abandon the change.</p>
DEMODULATOR DELAY	<p>Programs a switching delay of 0 to 127 seconds, in 0.5 second increments.</p> <p>Note: Ensure 1:1 switch is in INDEPENDENT mode</p> <p>Upon entry, the current status of the 1:1 switch is displayed. Press [←] or [→] to move the flashing cursor. Press [↑] or [↓] to increase or decrease the numbers. Press [ENTER] to execute the change, or [CLEAR] to abandon the change.</p>
MODULATORS	<p>Programs the modulators to ACTIVE or INACTIVE.</p> <p>Note: Ensure 1:1 switch is in MANUAL mode.</p> <p>Upon entry, the current status of the 1:1 switch is displayed. Press [ENTER], then use any of the arrow keys to select. Press [ENTER] to execute the change, or [CLEAR] to abandon the change.</p>
DEMODULATORS	<p>Programs the demodulators to ACTIVE or INACTIVE.</p>

	<p>Note: Ensure 1:1 switch is in MANUAL mode.</p> <p>Upon entry, the current status of the 1:1 switch is displayed. Press [ENTER], then use any of the arrow keys to select. Press [ENTER] to execute the change, or [CLEAR] to abandon the change.</p>
--	--

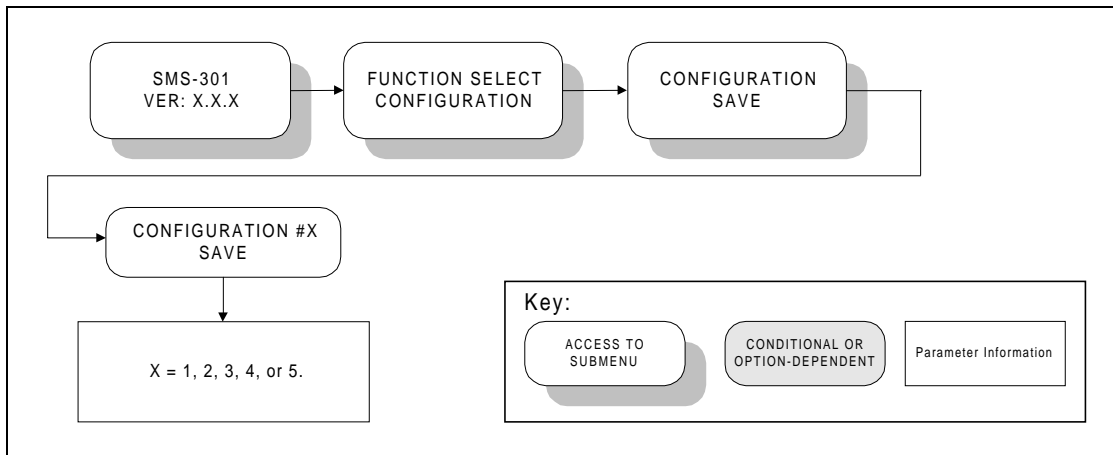

Figure 3-6. Configuration Save Menu

3.5.1.3 Configuration Save Menu

Refer to Figure 3-6.

<p>CONFIGURATION #X SAVE</p>	<p>X = 1, 2, 3, 4, or 5.</p> <p>Provides five memory locations for configurations to be saved into on the M&C.</p> <p>Press [ENTER], then use any of the arrow keys to select the desired memory location. Press [ENTER] to execute the save, or [CLEAR] to abandon the save.</p>
----------------------------------	---

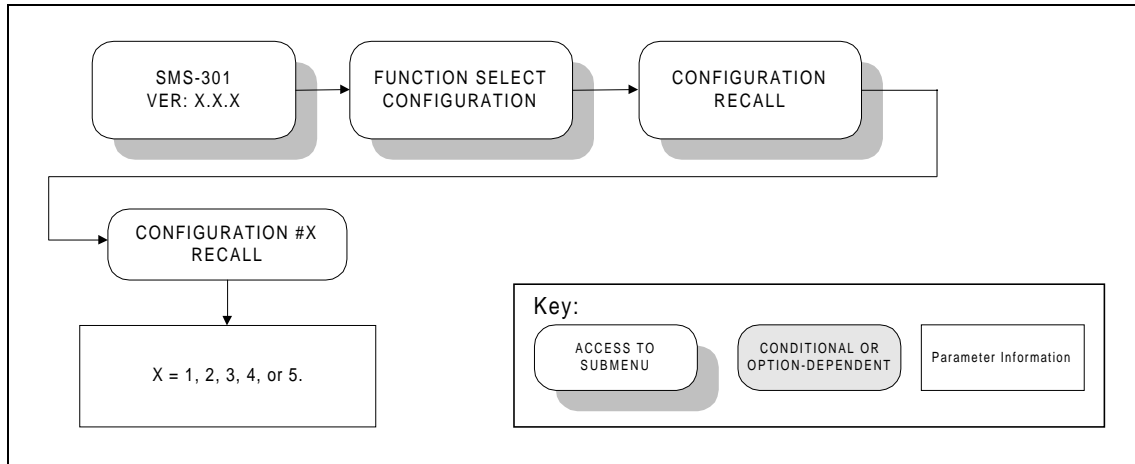

Figure 3-7. Configuration Recall Menu

3.5.1.4 Configuration Recall Menu

Refer to Figure 3-7.

<p>CONFIGURATION #X RECALL</p>	<p>X = 1, 2, 3, 4, or 5.</p> <p>Allows the recall of configurations that were previously saved on the M&C.</p> <p>Press [ENTER], then use any of the arrow keys to select the desired memory location. Press [ENTER] to execute the recall, or [CLEAR] to abandon the recall.</p>
------------------------------------	---

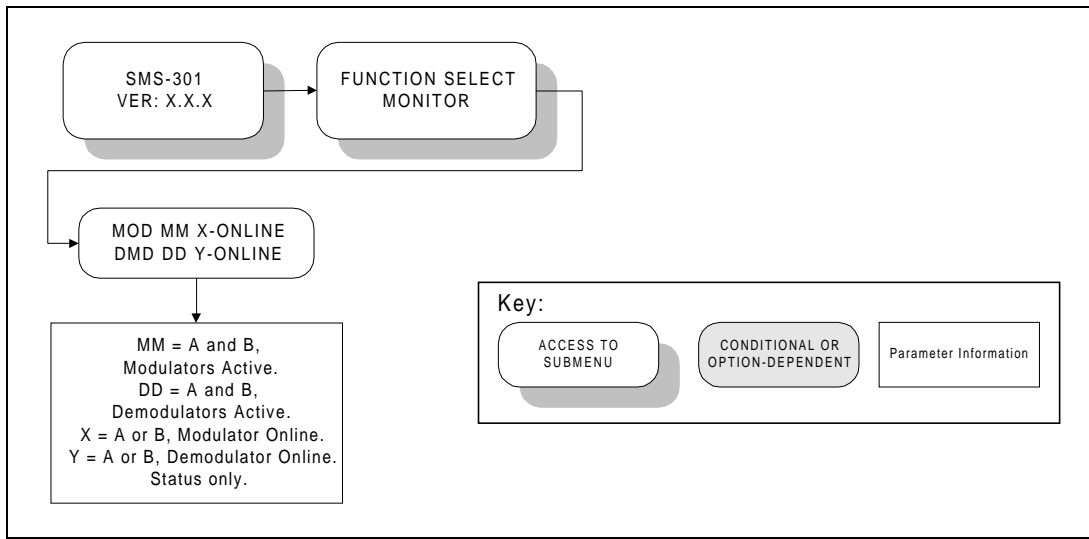

Figure 3-8. Monitor Menu

3.5.1.5 Monitor Menu

Refer to Figure 3-8.

<p>MOD MM X-ONLINE DMD DD Y-ONLINE</p>	<p>(Status Only.)</p> <p>Line 1 displays summary of active prime modems and online backup modems. Line 2 displays summary of active prime and online backup demodulators.</p> <p>Where:</p> <p>MM = A and B, indicates modulators are active. If not active, an “_” is displayed.</p> <p>DD = A and B, indicates demodulators are active. If not active, an “_” is displayed.</p> <p>X = A or B, indicates modulator A or B online.</p> <p>Y = A or B, indicates demodulators A or B online.</p>
--	--

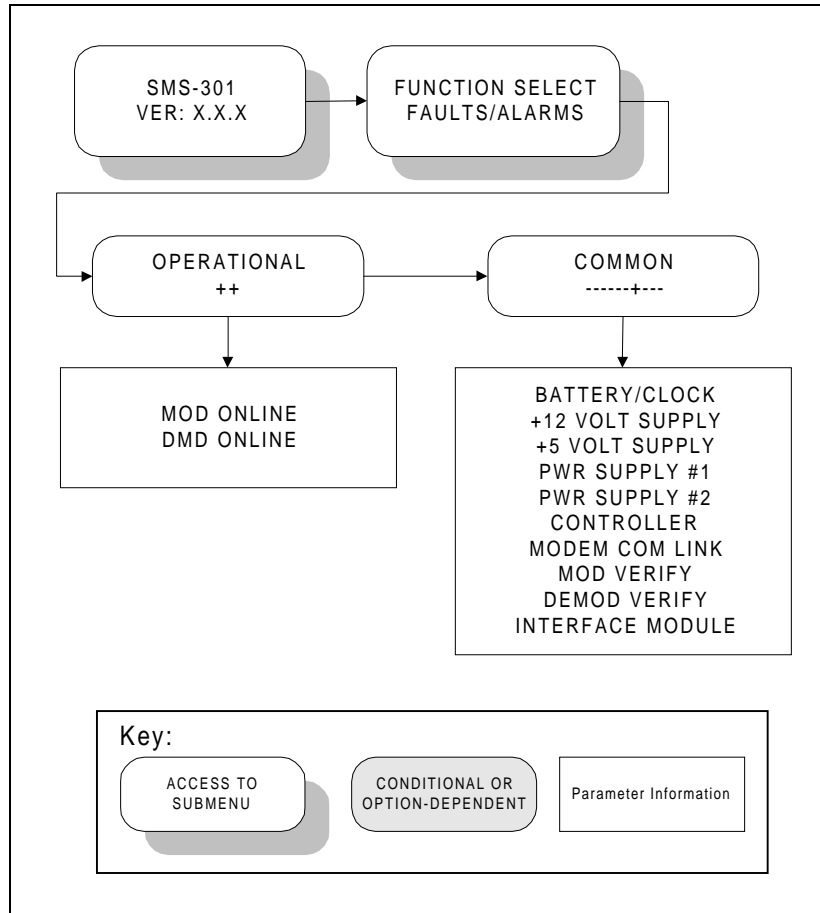

Figure 3-9. Faults/Alarms Menu

3.5.1.6 Faults/Alarms

Refer to Figure 3-9.

The Faults/Alarms level is accessible from the Function Select menu. Press [←] or [→] to move between the following Faults/Alarms groups:

OPERATIONAL X	<p>(Status Only)</p> <p>X = 0 through 9.</p> <p>Displays the fault status of the currently selected on-line modulator and demodulator.</p> <p>When a fault is present, the date and time of the fault is displayed alternately.</p>
COMMON	<p>(Status Only)</p> <p>Note: Date and time faults are also displayed.</p> <p>Use [←] or [→] to display faults within the 1:1 switch, such as the following:</p> <ul style="list-style-type: none"> • Battery Clock - Battery or clock fault. • +12V Supply - +12V supply fault. • +5V Supply - +5V supply fault • Power Supply #1 - Power supply #1 fault. • Power Supply #2 - Power supply #2 fault. • Controller - Controller power ON/OFF cycle fault. • Modem COMM Link - Modem communications fault. • Modem Verify- Prime and backup modems do not match. • DEMOD Verify - Prime and backup DEMODS do not match. • Interface Module - Interface module is missing or will not program fault.

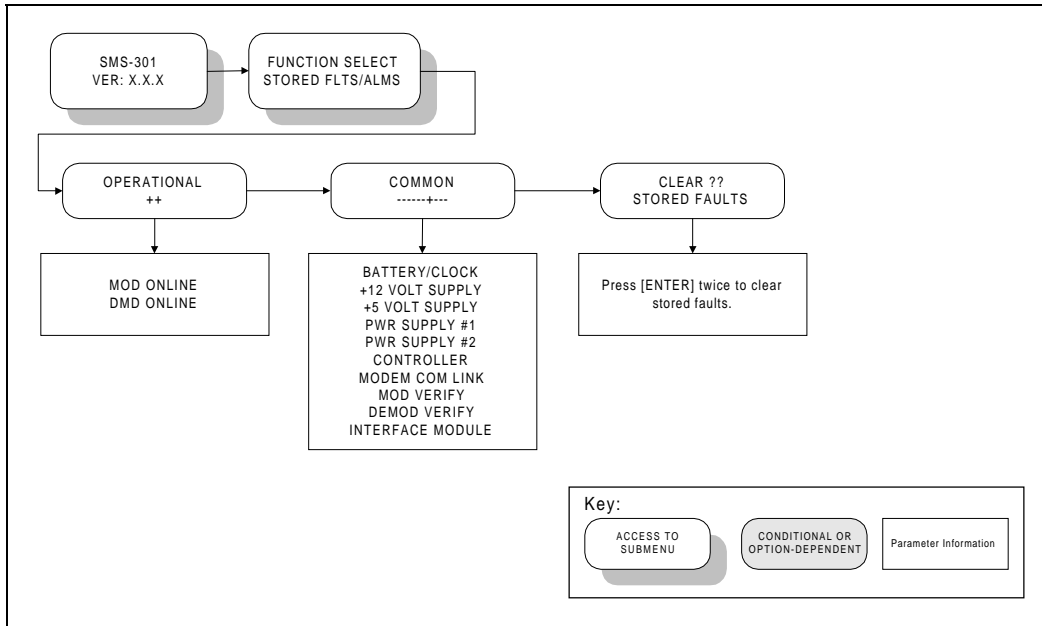

Figure 3-10. Stored Faults/Alarms Menu

3.5.1.7 Stored Faults/Alarms

Refer to Figure 3-10.

OPERATIONAL X	<p>(Status Only)</p> <p>X = 0 through 9.</p> <p>Displays the fault status of the currently selected on-line modulator and demodulator.</p> <p>When a stored fault is present, the date and time of the fault will be displayed alternately.</p>
COMMON	<p>(Status Only)</p> <p>Note: Date and time of faults also are displayed.</p> <p>Press [←] or [→] to display faults within the 1:1 switch, such as the following:</p> <ul style="list-style-type: none"> • Battery Clock - Battery or clock fault. • +12V Supply - +12V supply fault. • +5V Supply - +5V supply fault • Power Supply #1 - Power supply #1 fault. • Power Supply #2 - Power supply #2 fault. • Controller - Controller power ON/OFF cycle fault. • Modem COMM Link - Modem communications fault. • Modem Verify- Prime and backup modems do not match. • DEMOD Verify - Prime and backup DEMODS do not match. • Interface Module - Interface module is missing or will not program fault.
CLEAR?? STORED FAULTS	<p>Allows the operator to clear all stored faults within the memory of the 1:1 switch.</p> <p>Press [ENTER], then 'YES' is displayed. Press [ENTER] to confirm clearing all stored faults, or press [CLEAR] to exit without clearing stored faults.</p>

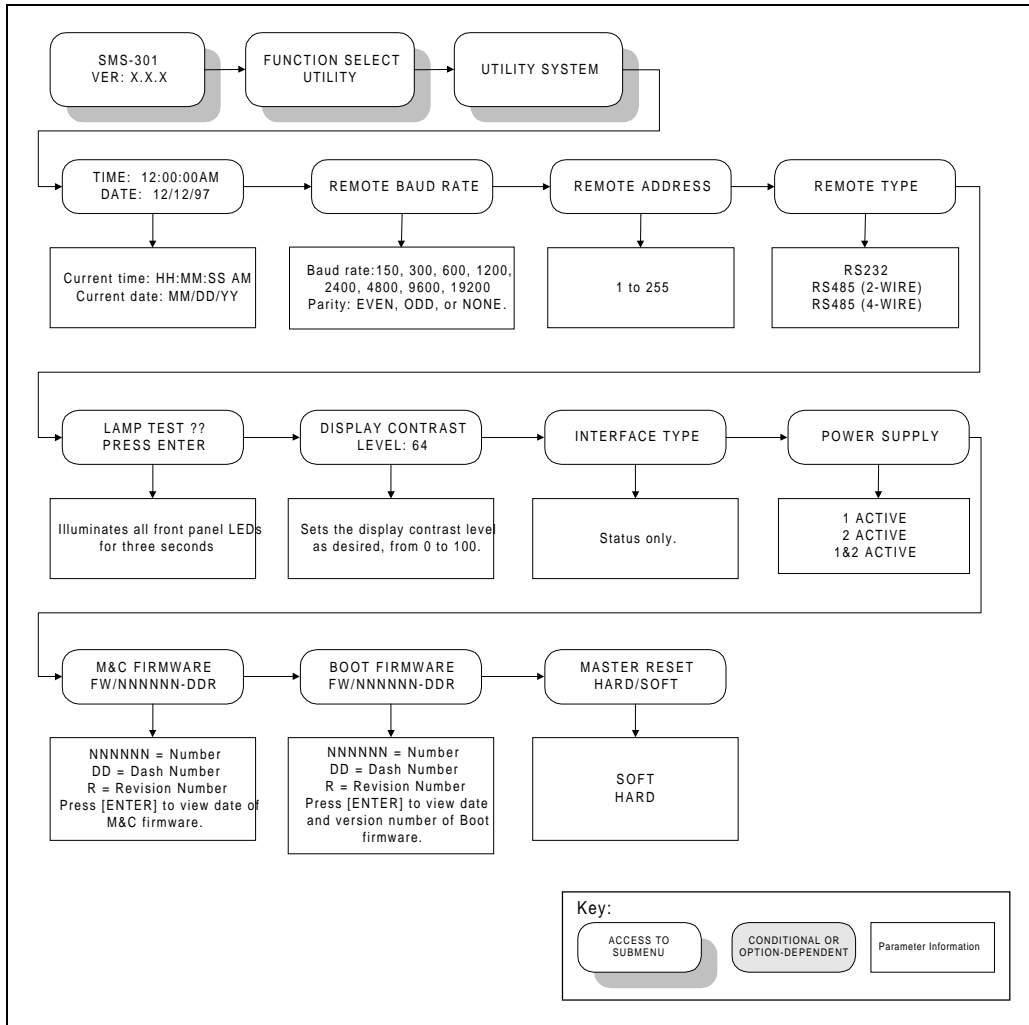



Figure 3-11. Utility System Menu

3.5.1.8 Utility System

Refer to Figure 3-11.

<p>TIME: HH:MM:SS AM DATE: MM/DD/YY</p>	<p>Time of day and date display/set function.</p> <p>To change the time and/or date:</p> <p>Note: Ensure 1:1 switch is in MANUAL mode.</p> <p>Press [←] or [→] to position the cursor over the parameter to be changed. Press [↑] or [↓] to change the parameter. Once the parameters are set as desired, press [ENTER] to set the time and date.</p>
<p>REMOTE BAUD RATE</p>	<p>The parity and baud rate settings of the 1:1 switch are displayed.</p> <p>To change the baud rate and/or parity, perform the following:</p> <p>Note: Ensure 1:1 switch is in MANUAL mode.</p> <p>The available baud rates are as follows: 150, 300, 600, 1200, 2400, 4800, 9600, or 19200 bps. Baud rates are set by pressing [ENTER], and then [↑] or [↓] to select the desired rate. Press [ENTER] to accept the change, or [CLEAR] to abandon the change.</p> <p>The parity can be set to EVEN, ODD, or NONE, by pressing [ENTER], [→] to place the cursor on the parity setting, and then [↑] or [↓] to select the desired setting. Press [ENTER] to accept the change, or [CLEAR] to abandon the change.</p>
<p>REMOTE ADDRESS</p>	<p>The current 1:1 switch address is displayed (1 to 255).</p> <p>To change the remote address, press [ENTER], then [←] or [→] to position the cursor over the parameter to be changed. Press [↑] or [↓] to change the parameter, then press [ENTER] to accept the change, or [CLEAR] to abandon the change.</p> <p>Note: A 0 address is reserved for global use only.</p>
<p>REMOTE TYPE</p>	<p>Displays the current remote type: EIA-232, EIA-485 (2-Wire), or EIA-485 (4-Wire).</p> <p>To change the remote type, press [ENTER], then any of the arrow keys to select the desired remote type. Press [ENTER] to accept the change, or [CLEAR] to abandon the change.</p>
<p>LAMP TEST ?? PRESS ENTER</p>	<p>Lamp test function. Press [ENTER] to turn all front panel LED indicators ON for 3 seconds.</p>

<p>DISPLAY CONTRAST</p>	<p>Sets the display contrast setting, as desired.</p> <p>Note: Ensure 1:1 switch is in MANUAL mode.</p> <p>To change the display contrast, press [ENTER], then [←] or [→] to position the cursor over the parameter to be changed. Press [↑] or [↓] to change the parameter, then press [ENTER] to accept the change, or [CLEAR] to abandon the change.</p>								
<p>INTERFACE TYPE</p>	<p>(Status Only)</p> <p>Displays the currently installed interface type, as follows:</p> <table border="0" style="width: 100%;"> <tr> <td style="width: 50%;">50-Pin</td> <td style="width: 50%;">25-Pin (V.35)</td> </tr> <tr> <td>37-Pin</td> <td>37-Pin (LVDS)</td> </tr> <tr> <td>25-Pin (EIA-232)</td> <td>37-Pin (EIA-422)</td> </tr> <tr> <td>25-Pin (EIA-530)</td> <td></td> </tr> </table>	50-Pin	25-Pin (V.35)	37-Pin	37-Pin (LVDS)	25-Pin (EIA-232)	37-Pin (EIA-422)	25-Pin (EIA-530)	
50-Pin	25-Pin (V.35)								
37-Pin	37-Pin (LVDS)								
25-Pin (EIA-232)	37-Pin (EIA-422)								
25-Pin (EIA-530)									
<p>POWER SUPPLY</p>	<p>Displays the currently selected power supply (1 ACTIVE, 2 ACTIVE, or 1&2 ACTIVE).</p> <p>To change the power supply setting, press [ENTER], then any of the arrow keys to select the desired setting. Press [ENTER] to accept the change, or [CLEAR] to abandon the change.</p>								
<p>M&C FIRMWARE</p>	<p>Displays the M&C firmware version number. Press [ENTER] to display the date of the M&C firmware.</p>								
<p>BOOT FIRMWARE</p>	<p>Displays the BOOT firmware version number. Press [ENTER] to display the date of the BOOT firmware.</p>								
<p>MASTER RESET HARD/SOFT</p>	<p>Master reset function (SOFT or HARD).</p> <div style="text-align: center;">  </div> <p>Initiating a HARD reset will reset the 1:1 switch and place the default configuration settings in ROM. Initiating a SOFT reset will reset the 1:1 switch hardware, but saves the current configuration settings.</p> <p>To perform a master reset, press [ENTER], any of the arrow keys to select the type, then press [ENTER] again. Press [→] five times to position the cursor on YES. Press [ENTER] to confirm the reset type and execute the reset, or [CLEAR] to change reset type and/or abandon the reset.</p> <p>Note: The following parameters do not revert to default settings after a hard reset:</p> <ul style="list-style-type: none"> Address Parity Baud Rate Remote Type Display Contrast 								

This page is intentionally left blank.

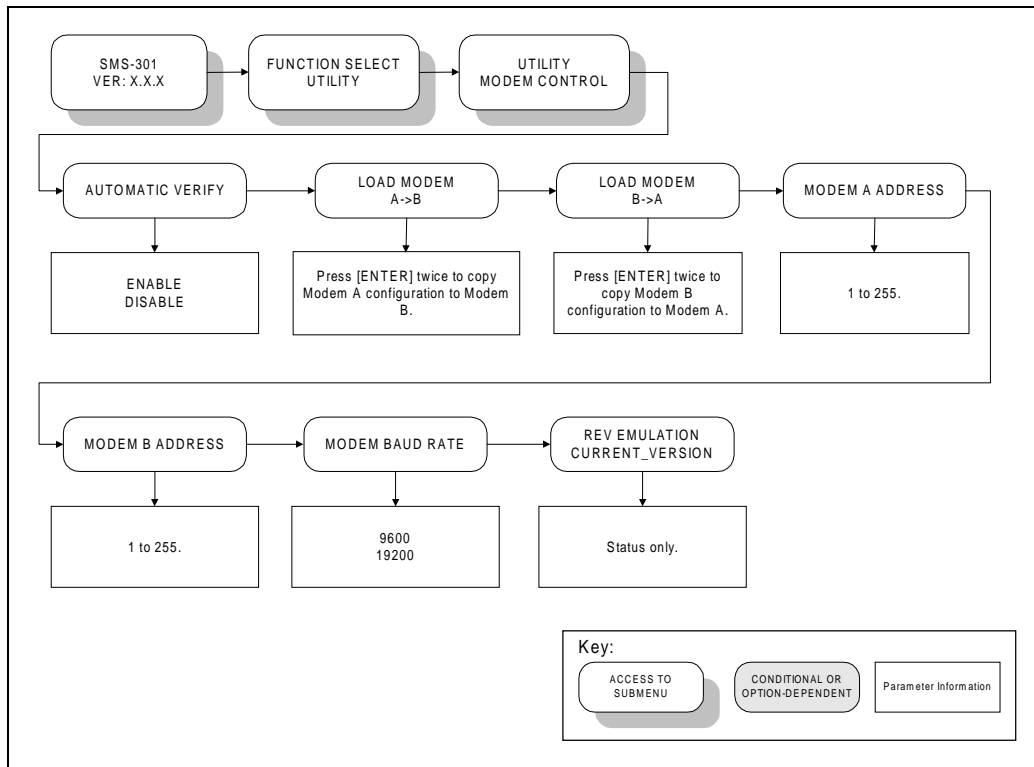

Figure 3-12. Utility Modem Control Menu

3.5.1.9 Utility Modem Control

Refer to Figure 3-12.

AUTOMATIC VERIFY	<p>Selects ENABLE or DISABLE for automatic verify feature.</p> <p>To change the setting, press [ENTER], then use any of the arrow keys to select. Press [ENTER] to accept the change, or [CLEAR] to abandon the change.</p>
LOAD MODEM A → B	<p>Copies Modem A configuration to Modem B.</p> <p>To perform the copy function, press [ENTER] twice.</p>
LOAD MODEM B → A	<p>Copies Modem B configuration to Modem A.</p> <p>To perform the copy function, press [ENTER] twice.</p>
MODEM A ADDRESS	<p>Selects an address from 1 to 255 for Modem A.</p> <p>To change the address for Modem A, press [ENTER], then [←] or [→] to position the cursor over the parameter to be changed. Press [↑] or [↓] to change the parameter, then press [ENTER] to accept the change, or [CLEAR] to abandon the change.</p> <p>Note: A 0 address is reserved for global use only.</p>
MODEM B ADDRESS	<p>Selects an address for Modem B.</p> <p>To change the address for Modem B, press [ENTER], then [←] or [→] to position the cursor over the parameter to be changed. Press [↑] or [↓] to change the parameter, then press [ENTER] to accept the change, or [CLEAR] to abandon the change.</p> <p>Note: A 0 address is reserved for global use only.</p>
MODEM BAUD RATE	<p>Selects the modem baud rate (9600 or 19200 bit/s).</p> <p>To change the modem baud rate, press [ENTER], then any of the arrow keys to select. Press [ENTER] to accept the change, or [CLEAR] to abandon the change.</p>

REV EMULATION	<p>Programs an emulation mode of the previous functional revision. This allows the operator to select the CURRENT VERSION or FUNCTIONAL X:</p> <p>Note: The number displayed in the CURRENT VERSION position increases with each software version change.</p> <p>Upon entry, the CURRENT VERSION is displayed. Press [↑] or [↓] to select the FUNCTIONAL version. Press [ENTER] to execute the change.</p> <p>Notes:</p> <ol style="list-style-type: none">1. Programming a current version (default) allows all features and options (if installed) to operate normally.2. Programming a FUNCTIONAL version (X) eliminates any changes that affect the later version. Only functional changes are affected by the revision emulation feature.3. A correction change (e.g., VER 1.1.1) remains fixed in accordance with the latest version. Since the revision emulation default is the current version, program the functional version at the start of each operation.4. The revision emulation feature does not affect some interface changes for the direct operation of the modem (Configuration Save/Recall, test mode screen in the Utility/System, all factory setup modes, etc.).
---------------	--

4 Chapter 4. THEORY OF OPERATION

This chapter provides the basic theory of operation for the following:

- M&C 75Ω
- M&C 50Ω
- IBS, IDR, ASYNC, D&I, 50-pin (PL/5951)
- EIA-422/-449, V.35, G.703, 37-pin (PL/5952)
- LVDS/DVB-TX, 37-pin (PL/6201-1)
- EIA-422/DVB-TX, 37-pin (PL/6201-2)
- EIA-232/-422/-530, V.35, G.703 25-pin (PL/6026)
- Remote Switch Option (RS-301), 100-pin (PL6592/6627)

4.1 Monitor and Control (M&C)

The M&C monitors the switch configuration, as well as 1:1 switch and modem faults and status. 1:1 switch configuration parameters are stored in battery-backed RAM to provide total recovery after a power-down. The 1:1 switch gathers status and provides extensive fault monitoring. A local front panel interface and a remote communications interface provide user access to all 1:1 switch functions.

4.1.1 Theory of Operation

The M&C module uses an Intel 80C32™ microcontroller operating at 11.0592 MHz. The microsystem supports 256 kbit/s of FLASH memory for code and data.

Memory-mapped I/O includes:

- Real time clock/memory
- 8-channel analog-to-digital converter
- External buffered bus structure for overall 1:1 switch control and status gathering.

The 80C32 microcontroller supports a serial, asynchronous, remote control (J10) communications channel (EIA-232 or EIA-485) with a maximum baud rate of 19200 bit/s.

The modem control interface (J13) is an EIA-485 serial communication link which allows the 1:1 switch to monitor and configure the attached modems.

A lithium battery maintains the system real time clock and 1:1 switch configuration through power-down situations.

The M&C motherboard interfaces and controls a variety of data interface connector switch boards. The customer-application dictates the type of connector switch board to be installed within the 1:1 switch.

4.2 SMS-301 Data Interface

4.2.1 IBS, IDR, ASYNC, or D&I (J1, J2, J3), 50-Pin (PL/5951)

The applications for this board are IDR, IBS, ASYNC, or D&I format data. The board consists of three 50-pin data I/O connectors, interface, and switching electronics. There are no configuration jumpers on the 50-pin board.

The interface to the M&C motherboard is via a 40-pin connector located along one side of the board. The board, under M&C control, will switch data between the prime modem (J2), and/or the backup modem (J3), and the common customer-data interface (J1).

The M&C automatically detects the type of board installed and presents this information, via the front panel display, under Interface Type in the Utility System menu.

4.2.2 EIA-422/-449, G.703, or V.35 (J1, J2, J3), 37-Pin (PL/5952)

The applications for this board are EIA-422/-449, G.703 or V.35 format data. The board consists of three 37-pin data I/O connectors, interface, and switching electronics.

The interface to the M&C motherboard is via a 40-pin connector located along one side of the board. The board, under M&C control, will switch data between the prime modem (J2), and/or the backup modem (J3), and the common customer-data interface (J1).

The M&C automatically detects the type of switch board installed and presents this information, via the front panel display, under Interface Type in the Utility System menu.

4.2.3 LVDS-DVB TX, (J1, J2, J3), 37-Pin, (PL/6201-1)

There are no configuration jumpers on the LVDS board. The current version of this board is for the SDM-2020 Satellite Modulator only. The intended signal flow path is from the customer-connection on J1 to the switched equipment on J2 and J3.

In the powered down state, this board provides an unbuffered signal path from J1 to J2. When power is available to the board, the signals from J1 to J2 and J3 are buffered.

4.2.4 EIA-422/DVB TX (J1, J2, J3), 25-Pin (PL/6026)

The applications for this switch board are EIA-232, EIA-422, or V.35 format data. The switch board consists of three 25-pin data I/O connectors, interface, and switching electronics.

The interface to the M&C motherboard is via a 40-pin connector located along one side of the switch board. The switch board, under M&C control, will switch data between the prime modem (J2), and/or the backup modem (J3), and the common customer-data interface (J1).

The M&C automatically detects the type of switch board installed and presents this information, via the front panel display, under Interface Type in the Utility System menu.

4.3 Remote Switch (RS-301) Option

The application for this option is to provide access to tributary data, via the remote switch, when the 1:1 switch is used with two SDM-300/-300A Satellite Modems that are configured for the 8-Channel MUX option.

For this option an extender board (AS/6542) replaces the switch board that normally resides within the 1:1 switch. This extender board interfaces with the M&C motherboard and provides control signals, power and ground to an external data switch (RS-301).

The remote switch (RS-301) provides the user with connections for eight tributary channels (EIA-422, EIA-232 data and clock) and one connection for auxiliary data. This switch, under M&C control, will switch data (only) between the prime modem and/or the backup modem, and the customer-data interface. The TX IF switching remains internal to the 1:1 switch.

The M&C automatically detects this switch option and presents this information, via the front panel display, under Interface Type in the Utility System menu.

The connectors for the remote switch are listed in Table 4-1.

Table 4-1. Remote Switch (RS-301) Connectors

Name	REF DES	Connector Type	Function	Table Reference
TRIBUTARY 1 DATA	J1	15-pin D	EIA-422 or EIA-232 TRIB 1 Clock and Data	Table 4-2
TRIBUTARY 2 DATA	J2	15-pin D	EIA-422 or EIA-232 TRIB 2 Clock and Data	Table 4-3
TRIBUTARY 3 DATA	J3	15-pin D	EIA-422 or EIA-232 TRIB 3 Clock and Data	Table 4-4
TRIBUTARY 4 DATA	J4	15-pin D	EIA-422 or EIA-232 TRIB 4 Clock and Data	Table 4-5
TRIBUTARY 5 DATA	J5	15-pin D	EIA-422 or EIA-232 TRIB 5 Clock and Data	Table 4-6
TRIBUTARY 6 DATA	J6	15-pin D	EIA-422 or EIA-232 TRIB 6 Clock and Data	Table 4-7
TRIBUTARY 7 DATA	J7	15-pin D	EIA-422 or EIA-232 TRIB 7 Clock and Data	Table 4-8
TRIBUTARY 8 DATA	J8	15-pin D	EIA-422 or EIA-232 TRIB 8 Clock and Data	Table 4-9
AUX	J9	15-pin D	Auxiliary Data	Table 4-10
MODEM A DATA	J14	100-pin Miniature D	Modem A Data I/O	Table 4-11
MODEM B DATA	J15	100-pin Miniature D	Modem B Data I/O	Table 4-12
SWITCH CONTROL INTERFACE	J16	37-pin D	Control Signals, Power and Ground	Table 4-13

Table 4-2. Tributary 1 Data (J1)

Pin No.	Name	Function
1	CTS422A1	EIA-422, Clear-to-Send A (-)
2, 5, 11	GND	Ground
3	TC422B-1	EIA-422, TX Clock B (+)
4	TD422A-1	EIA-422 TX Data A (-)
6	TD232-1	EIA-232 TX Data
9	CTS422B1	EIA-422 Clear-to-Send B (+)
10	TC422A-1	EIA-422 TX Clock A (-)
12	TD422B-1	EIA-422 TX Clock B (+)
13	CTS232-1	EIA-232 Clear-to-Send
14	TC232-1	EIA-232 TX Clock

Table 4-3. Tributary 2 Data (J2)

Pin No.	Name	Function
1	CTS422A2	EIA-422, Clear-to-Send A (-)
2, 5, 11	GND	Ground
3	TC422B-2	EIA-422, TX Clock B (+)
4	TD422A-2	EIA-422 TX Data A (-)
6	TD232-2	EIA-232 TX Data
9	CTS422B2	EIA-422 Clear-to-Send B (+)
10	TC422A-2	EIA-422 TX Clock A (-)
12	TD422B-2	EIA-422 TX Clock B (+)
13	CTS232-2	EIA-232 Clear-to-Send
14	TC232-2	EIA-232 TX Clock

Table 4-4. Tributary 3 Data (J3)

Pin No.	Name	Function
1	CTS422A3	EIA-422, Clear-to-Send A (-)
2, 5, 11	GND	Ground
3	TC422B-3	EIA-422, TX Clock B (+)
4	TD422A-3	EIA-422 TX Data A (-)
6	TD232-3	EIA-232 TX Data
9	CTS422B3	EIA-422 Clear-to-Send B (+)
10	TC422A-3	EIA-422 TX Clock A (-)
12	TD422B-3	EIA-422 TX Clock B (+)
13	CTS232-3	EIA-232 Clear-to-Send
14	TC232-3	EIA-232 TX Clock

Table 4-5. Tributary 4 Data (J4)

Pin No.	Name	Function
1	CTS422A4	EIA-422, Clear-to-Send A (-)
2, 5, 11	GND	Ground
3	TC422B-4	EIA-422, TX Clock B (+)
4	TD422A-4	EIA-422 TX Data A (-)
6	TD232-4	EIA-232 TX Data
9	CTS422B4	EIA-422 Clear-to-Send B (+)
10	TC422A-4	EIA-422 TX Clock A (-)
12	TD422B-4	EIA-422 TX Clock B (+)
13	CTS232-4	EIA-232 Clear-to-Send
14	TC232-4	EIA-232 TX Clock

Table 4-6. Tributary 5 Data (J5)

Pin No.	Name	Function
1	CTS422A5	EIA-422, Clear-to-Send A (-)
2, 5, 11	GND	Ground
3	TC422B-5	EIA-422, TX Clock B (+)
4	TD422A-5	EIA-422 TX Data A (-)
6	TD232-5	EIA-232 TX Data
9	CTS422B5	EIA-422 Clear-to-Send B (+)
10	TC422A-5	EIA-422 TX Clock A (-)
12	TD422B-5	EIA-422 TX Clock B (+)
13	CTS232-5	EIA-232 Clear-to-Send
14	TC232-5	EIA-232 TX Clock

Table 4-7. Tributary 6 Data (J6)

Pin No.	Name	Function
1	CTS422A6	EIA-422, Clear-to-Send A (-)
2, 5, 11	GND	Ground
3	TC422B-6	EIA-422, TX Clock B (+)
4	TD422A-6	EIA-422 TX Data A (-)
6	TD232-6	EIA-232 TX Data
9	CTS422B6	EIA-422 Clear-to-Send B (+)
10	TC422A-6	EIA-422 TX Clock A (-)
12	TD422B-6	EIA-422 TX Clock B (+)
13	CTS232-6	EIA-232 Clear-to-Send
14	TC232-6	EIA-232 TX Clock

Table 4-8. Tributary 7 Data (J7)

Pin No.	Name	Function
1	CTS422A7	EIA-422, Clear-to-Send A (-)
2,5,11	GND	Ground
3	TC422B-7	EIA-422, TX Clock B (+)
4	TD422A-7	EIA-422 TX Data A (-)
6	TD232-7	EIA-232 TX Data
9	CTS422B7	EIA-422 Clear-to-Send B (+)
10	TC422A-7	EIA-422 TX Clock A (-)
12	TD422B-7	EIA-422 TX Clock B (+)
13	CTS232-7	EIA-232 Clear-to-Send
14	TC232-7	EIA-232 TX Clock

Table 4-9. Tributary 8 Data (J8)

Pin No.	Name	Function
1	CTS422A8	EIA-422, Clear-to-Send A (-)
2,5,11	GND	Ground
3	TC422B-8	EIA-422, TX Clock B (+)
4	TD422A-8	EIA-422 TX Data A (-)
6	TD232-8	EIA-232 TX Data
9	CTS422B8	EIA-422 Clear-to-Send B (+)
10	TC422A-8	EIA-422 TX Clock A (-)
12	TD422B-8	EIA-422 TX Clock B (+)
13	CTS232-8	EIA-232 Clear-to-Send
14	TC232-8	EIA-232 TX Clock

Table 4-10. AUX Data (J9)

Pin No.	Name	Function
1	MCA	TX Aggregate Clock
2,5,11	GND	Ground
3	RT-B	EIA-422, RX Timing B (+)
4	RD-A	EIA-422, RX Data A (-)
6	RR-B	RX Ready B (+)
7	N/C	No Connection
8	MF	MOD Fault
9	MCB	TX Aggregate Data
10	RT-A	EIA-422, RX Timing A (-)
12	RD-B	EIA-422, RX Data B (+)
13	RR-A	RX Ready A (-)
14	N/C	No Connection
15	DF	DEMOM Fault

Table 4-11. Modem A Data (J14)

Pin #	Circuit	Description	Pin #	Circuit	Description
1	-	N/A	51	GND	GROUND
2	-	N/A	52	A_TC232_5	EIA-232, TX CLK, TRIB 5
3	-	N/A	53	A_TD232_5	EIA-232, TX DAT, TRIB 5
4	-	N/A	54	A_CTS232_5	EIA-232, CTS, TRIB 5
5	GND	GROUND	55	A_TD422B_5	EIA-422, TX DATB (+), TRIB 5
6	GND	GROUND	56	A_TD422A_5	EIA-422, TX DATA (-), TRIB 5
7	/A_DF	DEMOM FAULT	57	A_TC422B_5	EIA-422, TX CLKB (+), TRIB 5
8	/A_MF	MOD FAULT	58	A_TC422A_5	EIA-422, TX CLKA (-), TRIB 5
9	GND	GROUND	59	A_CTS422B5	EIA-422, CTSB (+), TRIB 5
10	A_RT+B	RECEIVE TIMING B (+)	60	A_CTS422A5	EIA-422, CTSA (-), TRIB 5
11	A_RT-A	RECEIVE TIMING A (-)	61	GND	GROUND
12	GND	GROUND	62	A_TC232_4	EIA-232, TX CLK, TRIB 4
13	A_RD+B	RECEIVE DATA B (+)	63	A_TD232_4	EIA-232, TX DAT, TRIB 4
14	A_RD-A	RECEIVE DATA A (-)	64	A_CTS232_4	EIA-232, CTS, TRIB 4
15	GND	GROUND	65	A_TD422B_4	EIA-422, TX DATB (+), TRIB 4
16	A_RR+B	RECEIVER READY B (+)	66	A_TD422A_4	EIA-422, TX DATA (-), TRIB 4
17	A_RR-A	RECEIVER READY A (-)	67	A_TC422B_4	EIA-422, TX CLKB (+), TRIB 4
18	GND	GROUND	68	A_TC422A_4	EIA-422, TX CLKA (-), TRIB 4
19	A_MCB	MASTER CLOCK B	69	A_CTS422B4	EIA-422, CTSB (+), TRIB 4
20	A_MCA	MASTER CLOCK A	70	A_CTS422A4	EIA-422, CTSA (-), TRIB 4
21	GND	GROUND	71	GND	GROUND
22	A_TC232_8	EIA-232, TX CLK, TRIB 8	72	A_TC232_3	EIA-232, TX CLK, TRIB 3
23	A_TD232_8	EIA-232, TX DAT, TRIB 8	73	A_TD232_3	EIA-232, TX DAT, TRIB 3
24	A_CTS232_8	EIA-232, CTS, TRIB 8	74	A_CTS232_3	EIA-232, CTS, TRIB 3
25	A_TD422B_8	EIA-422, TX DATB (+), TRIB 8	75	A_TD422B_3	EIA-422, TX DATB (+), TRIB 3
26	A_TD422A_8	EIA-422, TX DATA (-), TRIB 8	76	A_TD422A_3	EIA-422, TX DATA (-), TRIB 3
27	A_TC422B_8	EIA-422, TX CLKB (+), TRIB 8	77	A_TC422B_3	EIA-422, TX CLKB (+), TRIB 3
28	A_TC422A_8	EIA-422, TX CLKA (-), TRIB 8	78	A_TC422A_3	EIA-422, TX CLKA (-), TRIB 3
29	A_CTS422B8	EIA-422, CTSB (+), TRIB 8	79	A_CTS422B3	EIA-422, CTSB (+), TRIB 3
30	A_CTS422A8	EIA-422, CTSA (-), TRIB 8	80	A_CTS422A3	EIA-422, CTSA (-), TRIB 3
31	GND	GROUND	81	GND	GROUND
32	A_TC232_7	EIA-232, TX CLK, TRIB 7	82	A_TC232_2	EIA-232, TX CLK, TRIB 2
33	A_TD232_7	EIA-232, TX DAT, TRIB 7	83	A_TD232_2	EIA-232, TX DAT, TRIB 2
34	A_CTS232_7	EIA-232, CTS, TRIB 7	84	A_CTS232_2	EIA-232, CTS, TRIB 2
35	A_TD422B_7	EIA-422, TX DATB (+), TRIB 7	85	A_TD422B_2	EIA-422, TX DATB (+), TRIB 2
36	A_TD422A_7	EIA-422, TX DATA (-), TRIB 7	86	A_TD422A_2	EIA-422, TX DATA (-), TRIB 2
37	A_TC422B_7	EIA-422, TX CLKB (+), TRIB 7	87	A_TC422B_2	EIA-422, TX CLKB (+), TRIB 2
38	A_TC422A_7	EIA-422, TX CLKA (-), TRIB 7	88	A_TC422A_2	EIA-422, TX CLKA (-), TRIB 2
39	A_CTS422B7	EIA-422, CTSB (+), TRIB 7	89	A_CTS422B2	EIA-422, CTSB (+), TRIB 2
40	A_CTS422A7	EIA-422, CTSA (-), TRIB 7	90	A_CTS422A2	EIA-422, CTSA (-), TRIB 2
41	GND	GROUND	91	GND	GROUND
42	A_TC232_6	EIA-232, TX CLK, TRIB 6	92	A_TC232_1	EIA-232, TX CLK, TRIB 1
43	A_TD232_6	EIA-232, TX DAT, TRIB 6	93	A_TD232_1	EIA-232, TX DAT, TRIB 1
44	A_CTS232_6	EIA-232, CTS, TRIB 6	94	A_CTS232_1	EIA-232, CTS, TRIB 1
45	A_TD422B_6	EIA-422, TX DATB (+), TRIB 6	95	A_TD422B_1	EIA-422, TX DATB (+), TRIB 1
46	A_TD422A_6	EIA-422, TX DATA (-), TRIB 6	96	A_TD422A_1	EIA-422, TX DATA (-), TRIB 1
47	A_TC422B_6	EIA-422, TX CLKB (+), TRIB 6	97	A_TC422B_1	EIA-422, TX CLKB (+), TRIB 1
48	A_TC422A_6	EIA-422, TX CLKA (-), TRIB 6	98	A_TC422A_1	EIA-422, TX CLKA (-), TRIB 1
49	A_CTS422B6	EIA-422, CTSB (+), TRIB 6	99	A_CTS422B1	EIA-422, CTSB (+), TRIB 1
50	A_CTS422A6	EIA-422, CTSA (-), TRIB 6	100	A_CTS422A1	EIA-422, CTSA (-), TRIB 1

Table 4-12. Modem B Data (J15)

Pin #	Circuit	Description	Pin #	Circuit	Description
1	-	N/A	51	GND	GROUND
2	-	N/A	52	B_TC232_5	EIA-232, TX CLK, TRIB 5
3	-	N/A	53	B_TD232_5	EIA-232, TX DAT, TRIB 5
4	-	N/A	54	B_CTS232_5	EIA-232, CTS, TRIB 5
5	GND	GROUND	55	B_TD422B_5	EIA-422, TX DATB (+), TRIB 5
6	GND	GROUND	56	B_TD422A_5	EIA-422, TX DATA (-), TRIB 5
7	/B_DF	DEMOD FAULT	57	B_TC422B_5	EIA-422, TX CLKB (+), TRIB 5
8	/B_MF	MOD FAULT	58	B_TC422A_5	EIA-422, TX CLKA (-), TRIB 5
9	GND	GROUND	59	B_CTS422B5	EIA-422, CTSB (+), TRIB 5
10	B_RT+B	RECEIVE TIMING B(+)	60	B_CTS422A5	EIA-422, CTS (-), TRIB 5
11	B_RT-A	RECEIVE TIMING A(-)	61	GND	GROUND
12	GND	GROUND	62	B_TC232_4	EIA-232, TX CLK, TRIB 4
13	B_RD+B	RECEIVE DATA B(+)	63	B_TD232_4	EIA-232, TX DAT, TRI 4
14	B_RD-A	RECEIVE DATA A(-)	64	B_CTS232_4	EIA-232, CTS, TRIB 4
15	GND	GROUND	65	B_TD422B_4	EIA-422, TX DATB (+), TRIB 4
16	B_RR+B	RECEIVER READY B(+)	66	B_TD422A_4	EIA-422, TX DATA (-), TRIB 4
17	B_RR-A	RECEIVER READY A(-)	67	B_TC422B_4	EIA-422, TX CLKB (+), TRIB 4
18	GND	GROUND	68	B_TC422A_4	EIA-422, TX CLKA (-), TRIB 4
19	B_MCB	MASTER CLOCK B	69	B_CTS422B4	EIA-422, CTSB (+), TRIB 4
20	B_MCA	MASTER CLOCK A	70	B_CTS422A4	EIA-422, CTS (-), TRIB 4
21	GND	GROUND	71	GND	GROUND
22	B_TC232_8	EIA-232, TX CLK, TRIB 8	72	B_TC232_3	EIA-232, TX CLK, TRIB 3
23	B_TD232_8	EIA-232, TX DAT, TRI 8	73	B_TD232_3	EIA-232, TX DAT, TRI 3
24	B_CTS232_8	EIA-232, CTS, TRIB 8	74	B_CTS232_3	EIA-232, CTS, TRIB 3
25	B_TD422B_8	EIA-422, TX DATB (+), TRIB 8	75	B_TD422B_3	EIA-422, TX DATB (+), TRIB 3
26	B_TD422A_8	EIA-422, TX DATA (-), TRIB 8	76	B_TD422A_3	EIA-422, TX DATA (-), TRIB 3
27	B_TC422B_8	EIA-422, TX CLKB (+), TRIB 8	77	B_TC422B_3	EIA-422, TX CLKB (+), TRIB 3
28	B_TC422A_8	EIA-422, TX CLKA (-), TRIB 8	78	B_TC422A_3	EIA-422, TX CLKA (-), TRIB 3
29	B_CTS422B8	EIA-422, CTSB (+), TRIB 8	79	B_CTS422B3	EIA-422, CTSB (+), TRIB 3
30	B_CTS422A8	EIA-422, CTS (-), TRIB 8	80	B_CTS422A3	EIA-422, CTS (-), TRIB 3
31	GND	GROUND	81	GND	GROUND
32	B_TC232_7	EIA-232, TX CLK, TRIB 7	82	B_TC232_2	EIA-232, TX CLK, TRIB 2
33	B_TD232_7	EIA-232, TX DAT, TRI 7	83	B_TD232_2	EIA-232, TX DAT, TRI 2
34	B_CTS232_7	EIA-232, CTS, TRIB 7	84	B_CTS232_2	EIA-232, CTS, TRIB 2
35	B_TD422B_7	EIA-422, TX DATB (+), TRIB 7	85	B_TD422B_2	EIA-422, TX DATB (+), TRIB 2
36	B_TD422A_7	EIA-422, TX DATA (-), TRIB 7	86	B_TD422A_2	EIA-422, TX DATA (-), TRIB 2
37	B_TC422B_7	EIA-422, TX CLKB (+), TRIB 7	87	B_TC422B_2	EIA-422, TX CLKB (+), TRIB 2
38	B_TC422A_7	EIA-422, TX CLKA (-) TRIB 7	88	B_TC422A_2	EIA-422, TX CLKA (-), TRIB 2
39	B_CTS422B7	EIA-422, CTSB (+), TRIB 7	89	B_CTS422B2	EIA-422, CTSB (+), TRIB 2
40	B_CTS422A7	EIA-422, CTS (-), TRIB 7	90	B_CTS422A2	EIA-422, CTS (-), TRIB 2
41	GND	GROUND	91	GND	GROUND
42	B_TC232_6	EIA-232, TX CLK, TRIB 6	92	B_TC232_1	EIA-232, TX CLK, TRIB 1
43	B_TD232_6	EIA-232, TX DAT, TRI 6	93	B_TD232_1	EIA-232, TX DAT, TRIB 1
44	B_CTS232_6	EIA-232, CTS, TRIB 6	94	B_CTS232_1	EIA-232, CTS, TRIB 1
45	B_TD422B_6	EIA-422, TX DATB (+), TRIB 6	95	B_TD422B_1	EIA-422, TX DATB (+), TRIB 1
46	B_TD422A_6	EIA-422, TX DATA (-), TRIB 6	96	B_TD422A_1	EIA-422, TX DATA (-), TRIB 1
47	B_TC422B_6	EIA-422, TX CLKB (+), TRIB 6	97	B_TC422B_1	EIA-422, TX CLKB (+), TRIB 1
48	B_TC422A_6	EIA-422, TX CLKA (-), TRIB 6	98	B_TC422A_1	EIA-422, TX CLKA (-), TRIB 1
49	B_CTS422B6	EIA-422, CTSB (+), TRIB 6	99	B_CTS422B1	EIA-422, CTSB (+), TRIB 1
50	B_CTS422A6	EIA-422, CTS (-), TRIB 6	100	B_CTS422A1	EIA-422, CTS (-), TRIB 1

Table 4-13. Switch Control Interface (J16)

Pin No.	Name	Function
1	SCL	Serial Clock
20	SDA	Serial Data
2	Spare 11	No Connection
21	Spare 10	No Connection
3	Spare 9	No Connection
22	Spare 8	No Connection
4	Spare 7	No Connection
23	Spare 6	No Connection
5	Spare 5	No Connection
24	Spare 4	No Connection
6	Spare 3	No Connection
25	Spare 2	No Connection
7	Spare 1	No Connection
26	DMDONL	Demod Online
8	MODONL	Mod Online
27	/B_DF	Modem B Demod Fault
9	/A_DF	Modem A Demod Fault
28	/B_MF	Modem B Mod Fault
10	/A_MF	Modem A Mod Fault
29	ID_5	Interface Board ID
11	ID_4	Interface Board ID
30	ID_3	Interface Board ID
12	ID_2	Interface Board ID
31	ID_1	Interface Board ID
13	GND	Ground
32	GND	Ground
14	GND	Ground
33	GND	Ground
15	GND	Ground
34	-12V	-12VDC
16	-12V	-12VDC
35	+12V	+12VDC
17	+12V	+12VDC
36	+5V	+5VDC
18	+5V	+5VDC
37	+5V	+5VDC
19	+5V	+5VDC

This page is intentionally left blank.

5 Chapter 5. MAINTENANCE

This chapter provides the following information:

- Test Points and LEDs
- Fault Isolation

5.1 Software Revisions

The installation of revised controller software may be necessary to implement additions or enhanced features and/or corrective action. The control software resides in a programmable device inside the one unit (1U) switch control chassis (AS/6051).

Remove and replace U30 and/or U32 on printed circuit assembly as follows:



When replacing the 1:1 switch software, the previous switch configuration and loaded modem configurations will be lost.

1. Disconnect power supply from the 1:1 switch.
2. Disconnect and remove 1:1 switch from equipment rack.
3. Remove top cover fasteners and cover.
4. Remove and replace U30 and/or U32 on printed circuit assembly, AS/5950. U30 and U32 are socketed devices.
5. Replace cover and fasteners.
6. Position and reconnect the 1:1 switch in rack.
7. Reconnect power supply to the 1:1 switch.
8. Enter desired 1:1 switch configuration.
9. Load all modems from Load/Verify menu or remote terminal.
10. Resume Auto mode as required.

5.2 Test Points and LEDs

Test points and LEDs are included on the M&C board for quick troubleshooting references. LEDs are visual references. Test points are used when additional troubleshooting is required.

Refer to Table 5-1 for a list of LEDs and their functions.

Table 5-1. LED Functions

Function	Color
Demodulator A On-line	Green
Demodulator B On-line	Green
Modulator A On-line	Green
Modulator B On-line	Green
Transmit Fault	Red
Receive Fault	Red
System Fault	Red
Stored Fault	Yellow
Power Supply 1	Green
Power Supply 2	Green
Auto Mode	Green
Manual Mode	Yellow

5.3 Fault Isolation

System faults are reported in the Fault menu. Refer to Table 5-2 for guidelines to isolate problems, and the appropriate action(s) to be taken.

Table 5-2. Fault Isolation, 1:1 Switch

Fault	Description	Action
Battery/Clock	Corrupted non-volatile memory detected after hard reset or power-up.	<ol style="list-style-type: none"> 1. Replace lithium backup battery. 2. Replace M&C board if fault still occurs after battery replacement.
+12 Volt Supply Fault +5 Volt Supply Fault	Set when power supply voltage(s) are out-of-tolerance.	<ol style="list-style-type: none"> 1. Check AC power cord. 2. Check for blown fuse(s) in AC entry module. 3. Replace faulted power supply.
Power Supply #1 Fault Power Supply #2 Fault	Set when power supply voltage(s) are out-of-tolerance.	<ol style="list-style-type: none"> 1. Check AC power cord. 2. Check for blown fuse(s) in AC entry module. 3. Replace faulted power supply.
Controller Fault	M&C controller error detected on power-up.	Replace M&C board.
Modem COM Link	Modem fails to respond to 1:1 switch commands on the modem remote bus, J13.	<ol style="list-style-type: none"> 1. Verify modem communications parameters (including address assignments) agree with 1:1 switch configuration. 2. If single modem failure, check modem connector and modem. 3. If complete modem failure, check 1:1 switch connector and remote cable.
Mod/Demod Verify Error	Results from inconsistencies between configuration stored in 1:1 switch and configuration reported by modem.	Reload modem configuration from Modem Control, Utility menu.
Module Fault	Internal I ² C bus failure.	<ol style="list-style-type: none"> 1. Replace M&C board. 2. If problems persists, replace connector 1:1 switch board.

Appendix A.

REMOTE CONTROL OPERATION

This appendix describes the protocol and command structure for remote control and status monitoring of the 1:1 Redundancy Switch.

- Firmware number: FW/6055-1F and FW/6056
- Software version: 1.1.7

A.1 General

Remote controls and status information are transferred via an EIA-485 (optional EIA-232) serial communications link.

Commands and data are transferred on the remote control communications link as US ASCII-encoded character strings.

The remote communications link is operated in a half-duplex mode.

Communications on the remote link are initiated by a remote controller or terminal. The 1:1 switch never transmits data on the link unless it is commanded to do so.

Command and status parameter selection will be determined by whether the backup modem switching mode has been configured as Independent or Dependent. The 1:1 switch will default to Independent mode after a cold startup or hard reset has been initiated.

A.2 Message Structure

The ASCII character format used requires 11 bits/character:

- 7 information bits
- 2 stop bits
- 1 parity bit (Odd/Even)
- 1 start bit

Messages on the remote link fall into the categories of commands and responses.

Commands are messages which are transmitted to a switch, while responses are messages returned by a switch in response to a command.

The general message structure is as follows:

- Start Character
- Device Address
- Command/Response
- End of Message Character

A.2.1 Start Character

A single character precedes all messages transmitted on the remote link. This character flags the start of a message. This character is:

- “<” for commands
- “>” for responses

For any command that the 1:1 switch is passing through, an additional start character is added to the beginning of the message. This informs the operator that this command was a relayed command. This is true for the modem control link and the operator’s communications link. In order for a command to be relayed through the 1:1 switch, the address in the message must match the address that has been assigned to Modem A or Modem B.

A.2.2 Device Address

The device address is the address of the 1:1 switch which is designated to receive a transmitted command, or which is responding to a command.

Valid device addresses are 1 to 3 characters long, and in the range of 1 to 255. Address 0 is reserved as a global address which simultaneously addresses all devices on a given communications link. Devices do not acknowledge global commands.

Each 1:1 switch which is connected to a common remote communications link must be assigned its own unique address. Addresses are software selectable at the modem, and must be in the range of 1 to 255.

A.2.3 Command/Response

The command/response portion of the message contains a variable-length character sequence which conveys command and response data.

If a 1:1 switch receives a message addressed to it which does not match the established protocol or cannot be implemented, a negative acknowledgment message is sent in response. This message is:

```
>add/?ER2_invalid  
parameter'cr''lf']
```

(Error message for a recognized command which cannot be implemented or has parameters which are out of range.)

```
>add/?ER3_unrecognizable  
command'cr''lf']
```

(Error message for unrecognizable command or bad command syntax.)

```
>add/?ER4_modem in local  
mode'cr''lf']
```

(Modem in local error; send the REM command to go to remote mode.)

```
>add/?ER5_hard coded  
parameter'cr''lf']
```

(Error message indicating that the parameter is hardware dependent and may not be changed remotely.)

```
>add/?ER6_budy'cr''lf']
```

(Error message indicating that the command sent cannot be carried out because local processing is utilizing the modem control bus.)

The 1:1 switch does not respond to erred communications (i.e., parity and framing errors.)

Note: “add” is used to indicate a valid 1 to 3 character device address in the range between 1 and 255.

A.2.4 End Character

Each message is ended with a single character which signals the end of the message:

- “cr” Carriage return character for commands
- “]” End bracket for responses

A.3 Configuration Commands/Responses

Operational Mode	Command: Response:	<add/MODE_XXXXX'cr' >add/MODE_XXXXX'cr''lf]	Where: XXXXX = AUTO or MANUAL. This command selects the mode of operation for the SMS301. Notes: 1. If AUTO is selected, the Monitor and Control in the SMS301 controls all switching decisions. 2. If MANUAL is selected, the operator controls all switching decisions via the next 3 following commands.
Set Online Modulator (Independent Switching)	Command: Response:	<add/MOL_x'cr' (See Note) >add/MOL_x'cr''lf]	Where: x = A or B (Modulator Online number). This command puts the specified modulator online. Note: Manual Mode Only.
Set Online Demod (Independent Switching)	Command: Response:	<add/DOL_x'cr' (See Note) >add/DOL_x'cr''lf]	Where: x = A or B (Demodulator Online number). This command puts the specified demodulator online. Note: Manual Mode Only.
Set Online Modem (Dependent Switching)	Command: Response:	<add/MOL_x'cr' (See Note) >add/MOL_x'cr''lf]	Where: x = A or B (Modem Online number). This command puts the specified modem online. Note: Manual Mode Only.
Modulator's Active (Enable)	Command: Response:	<add/MA_yyy'cr' (See Note) >add/MA_yyy'cr''lf]	Where: yyy = YES or NO. Note: Manual Mode Only.
Demod Active (Enable)	Command: Response:	<add/DA_yyy'cr' (See Note) >add/DA_yyy'cr''lf]	Where: yyy = YES or NO. Note: Manual Mode Only.
Switching Mode Selection	Command: Response:	<add/SM_yyy'cr' (See Note) >add/SM_yyy'cr''lf]	Where: yyy = IND (Independent) or DEP (Dependent). Note: Manual Mode Only.
Modem Online Delay (Dependent Switching)	Command: Response:	<add/MD_yyy.y'cr' >add/MD_yyy.y'cr''lf]	Where: yyy.y = 0.0 to 127.0 seconds (in .5 second increments).
Modulator Online Delay (Independent Switching)	Command: Response:	<add/MD_yyy.y'cr' >add/MD_yyy.y'cr''lf]	Where: yyy.y = 0.0 to 127.0 seconds (in .5 second increments).

Demod Online Delay (Independent Switching)	Command: Response:	<add/DD_yyy.y'cr' >add/DD_yyy.y'cr''lf]	Where: yyy.y = 0.0 to 127.0 seconds (in .5 second increments).
	Status: Response:	<add/DD_'cr' >add/DD_yyy.y'cr''lf]	

A.4 Modem Communications Configuration Commands/Responses

Modem Control Baud Rate	Command: Response:	<add/MBR_mmmmm'cr' (See Note) >add/MBR_mmmmm'cr''lf]	Where: mmmmm = 9600 or 19200. Note: Manual Mode Only.
	Status: Response:	<add/MBR_'cr' >add/MBR_mmmmm'cr''lf]	
Modem Address	Command: Response:	<add/ADD_x_yyy'cr' >add/ADD_x_yyy'cr''lf]	Where: x = A to B (modem number). yyy = 0 to 255 (modem address, 0 puts modem out of service).
	Status: Response:	<add/ADD_x'cr' >add/ADD_x_yyy'cr''lf]	
Load Modem Config.	Command: Response:	<add/LMC_x'cr' (See Note) >add/LMC_x'cr''lf]	Where: x = A or B (modem number). Note: Manual Mode Only.
Automatic Verify Enable	Command: Response:	<add/AVE_xxx'cr' >add/AVE_xxx'cr''lf]	Where: xxx = ON (Enable) or OFF (Disable).
	Status: Response:	<add/AVE_xxx'cr' >add/AVE_xxx'cr''lf]	

A.5 System Commands/Responses

Time Of Day	Command: Response:	<add/TIME_hh:mmxx'cr' >add/TIME_hh:mmxx'cr"lf]	Where: hh = 1 to 12 (hours). mm = 00 to 59 (minutes). xx = AM or PM.
	Status: Response:	<add/TIME_'cr' >add/TIME_hh:mmxx'cr"lf]	
Date	Command: Response:	<add/DATE_mm/dd/yy'cr' >add/DATE_mm/dd/yy'cr"lf]	Where: mm = 1 to 12 (month). dd = 1 to 31 (day). yy = 00 to 99 (year).
	Status: Response:	<add/DATE_'cr' >add/DATE_mm/dd/yy'cr"lf]	
Remote Operation	Command: Response:	<add/REM_'cr' >add/REM_'cr"lf]	Configures the SMS301 for remote operation. The SMS301 will respond to any status request at any time. However, the SMS301 must be in 'Remote Mode' to change configuration parameters remotely.
Clear Stored Faults	Command: Response:	<add/CLSF_'cr' >add/CLSF_'cr"lf]	This command is used to clear all stored faults logged by the SMS301.
Power Supply Monitor	Command: Response:	<add/PS_xxx'cr' >add/PS_xxx'cr"lf]	Where: xxx = 1 (monitor power supply #1), 2 (monitor power supply #2), 1&2 (monitor power supply #1 & #2).
	Status: Response:	<add/PS_'cr' >add/PS_xxx'cr"lf]	
Save Switch Config.	Command: Response:	<add/SMC_n'cr' >add/SMC_n'cr"lf]	Where: n = 1, 2, 3, 4, or 5 (stored configuration number). This command saves the current switch configuration for recall at a later time using the "RMC_" command. Up to five different switch configurations can be saved.
Recall Switch Config.	Command: Response:	<add/RMC_n'cr' >add/RMC_n'cr"lf]	Where: n = 1, 2, 3, 4, or 5 (stored configuration number). This command causes the switch to be reprogrammed with configuration parameters previously saved using the "SMC_" command. One of five saved configurations can be specified.

A.6 Status Commands/Responses

Modulator Config. Status	Command: Response:	<add/MCS_'cr' >add/MCS_'cr' MODE_XXXXXX'cr' SM_XXX'cr' MA_YYY'cr' MD_YYY.Y'cr' ADD_A_YYY'cr' ADD_B_YYY'cr''lf']	<p>Operation Mode Switching Mode Modulator's Active Modulator/Modem Delay A Modem Address B Modem Address</p> <p>The Modulator configuration status command causes a block of data to be returned by the SMS301.</p> <p>Note: *1* = dependent mode only, *2* = independent mode only.</p>
Demod Config. Status	Command: Response:	<add/DCS_'cr' >add/DCS_'cr' MODE_XXXXXX'cr' SM_XXX'cr' DA_YYY'cr' + DD_YYY.Y'cr' # MD_YYY.Y'cr' ADD_A_YYY'cr' ADD_B_YYY'cr''lf']	<p>Operation Mode Switching Mode Demodulator's Active Demodulator Delay Modem Delay A Modem Address B Modem Address</p> <p>The Demodulator configuration status command causes a block of data to be returned by the SMS301.</p> <p>+ Note: Status only returned in Independent Mode. # Note: Status only returned in Dependent Mode.</p>
Modulator Status	Command: Response:	<add/MS_'cr' >add/MS_'cr' MOD_A_XXX'cr' MOD_B_XXX'cr''lf']	<p>A Modulator Status (OK/FLT) B Modulator Status (OK/FLT)</p> <p>The Modulator status is returned as a block of data which provides fault information of all 'active' Modulators.</p> <p>Note: Response shown is for a system with all possible modulators active. Only active modulator status will be reported.</p>
Demod Status	Command: Response:	<add/DS_'cr' >add/DS_'cr' DMD_A_XXX'cr' DMD_B_XXX'cr''lf']	<p>A Demodulator Status (OK/FLT) B Demodulator Status (OK/FLT)</p> <p>The Demodulator status is returned as a block of data which provides fault information of all 'active' Demodulators.</p> <p>Note: Response shown is for a system with all possible demodulators active. Only active modulator status will be reported.</p>

A.7 Fault Summary Status Commands/Responses

Operational Faults Status	Command: Response:	<add/OFS_'cr' >add/OFS_'cr' MOD_XXX'cr' DMD_XXX'cr' SFLT_XX'cr'lf']	TX Operational Status (OK/FLT) RX Operational Status (OK/FLT) Number of Stored Faults Logged (0 to 10)
System Fault Status Summary	Command: Response:	<add/SFS_'cr' >add/SFS_'cr' M&C_XXX'cr' INT_XXX'cr' BAT_XXX'cr' +5_XXX'cr' +12_XXX'cr' PS1_XXX'cr' PS2_XXX'cr' COM_XXX'cr' MVFY_XXX'cr' DVFY_XXX'cr' SFLT_XX'cr'lf']	Monitor & Control Module (OK/FLT) Data Interface/Overhead Module (OK/FLT) Battery/Clock (OK/FLT) +5V Power Supply (OK/FLT) +12V Power Supply (OK/FLT) Power Supply #1 (OK/FLT) Power Supply #2 (OK/FLT) Modem Communications (OK/FLT) Mod Config Verify (OK/FLT) Demod Config Verify (OK/FLT) Number of stored faults logged (0 to 10)

A.8 Stored Faults

Information on stored faults is returned when requested. If no stored fault exists for a given fault number, the words “NO Fault” will be returned instead of the normal time/date status information.

The following symbols are commonly used to define the stored faults status commands:

- # Fault number (0 to 9). “0” is the first fault stored.
- hh Hours in 24-hr. format.
- mm Minutes.
- ss Seconds.
- MM Month.
- DD Day.
- YY Year.

Operational Stored Faults	Command: Response:	<add/OSF_#’cr’ >add/OSF_# hh:mm:ss MM/DD/YY’cr’ MOD_XXX’cr’ DMD_XXX’cr’lf]	TX Operational Status (OK/FLT) RX Operational Status (OK/FLT)
System Stored Faults	Command: Response:	<add/SSF_#’cr’ >add/SSF_# hh:mm:ss MM/DD/YY’cr’ M&C_XXX’cr’ INT_XXX’cr’ BAT_XXX’cr’ +5_XXX’cr’ +12_XXX’cr’ PS1_XXX’cr’ PS2_XXX’cr’ COM_XXX’cr’ MVFY_XXX’cr’ DVFY_XXX’cr’lf]	Monitor & Control Module (OK/FLT) Data Interface/Overhead Module (OK/FLT) Battery/Clock (OK/FLT) +5V Power Supply (OK/FLT) +12V Power Supply (OK/FLT) Power Supply #1 (OK/FLT) Power Supply #2 (OK/FLT) Modem Communications (OK/FLT) Mod Config Verify (OK/FLT) Demod Config Verify (OK/FLT)

Bulk Consol. Status	Command: Response:	<add/BCS_'cr' >add/BCS_p1,p2,p3, . . . pn'cr'lf']	This command causes bulk switch status to be returned. To reduce the length of the response, message parameter data are returned without identifiers. However, parameter identification can be determined by order of return. Each status parameter is terminated with a ',' (comma) except for the last parameter which has the standard message termination sequence ('cr'lf'). Most of the data returned is formatted the same way as the single command status request (refer to the appropriate portions of this document in preceding sections). Additional configuration status of new options and features will always be appended to the end.
---------------------------	-----------------------	--	--

Where 'pn' is the last parameter returned.

Parameter Number	Parameter Name (Command Reference)	Description
1	Operation Mode (ref. "MODE_" command).	p1 = n, where 'n' is '0' (MANUAL), '1' (AUTO).
2	Switching Mode (ref. "SM_" command).	p2 = n, where 'n' is '0' (INDEPENDENT), '1' (DEPENDENT).
3	Modulator's Active (ref. "MA_" command).	p3 = n, where 'n' is '0' (DISABLED), '1' (ENABLED).
4	Demodulator's Active (ref. "DA_" command).	p4 = n, where 'n' is '0' (DISABLED), '1' (ENABLED).
5	Modulator/Modem Delay (ref. "MD_" command).	p5 = nnn.n, delay in seconds.
6	Demodulator Delay (ref. "DD_" command).	p6 = nnn.n, delay in seconds.
7	Power Supply Monitor (ref. "PS_" command).	p7 = n, where 'n' is '0' for Supply #1, '1' for Supply #2, and '2' for supply #1 and #2.
8	Modem A Address (ref. "ADD_A" command).	p8 = nnn, 0 to 255 is the Modem A address.
9	Modem B Address (ref. "ADD_B" command).	p9 = nnn, 0 to 255 is the Modem B address.
10	MODEM REMOTE/LOCAL mode.	p10 = n, where 'n' is '0' (LOCAL), '1' (REMOTE).
11	Auto verify mode. (ref. "AVE_" command).	p11 = n, where 'n' is '0' (DISABLED), '1' (ENABLED).
12	Modem Control Baud Rate (ref. MBR_command).	p12 = n, where 'n' is '0' (9600), '1' (19200).
13	Modulator/Modem Online (ref. "MOL_" command).	p13 = n, where 'n' is '0' (Mod A), '1' (Mod B).
14	Demodulator Online (ref. "DOL_" command).	p14 = n, where 'n' is '0' (Demod), '1' (Demod B). (Note this command will always respond with the current demod status.)

Equipment Type	Command: Response:	<add/ET_'cr' >add/ET_tttttt_xxx.yyy.zzz'cr'lf]	Where: tttttt = Equipment Type. xxx.yyy.zzz = Software Version number (0.0.0 to 999.999.999). This command returns the equipment type and the software version of the addressed device.
Monitor & Control Firmware Information	Command: Response:	<add/MCFI_'cr' >add/MCFI_'cr' VER_xxx.yyy.zzz'cr' FW/nnnnnn-ddr'cr' mm/dd/yy'cr'lf]	Where: xxx.yyy.zzz = Software version number (0.0.0 to 999.999.999). nnnnnn = Firmware number (0 to 999999). dd = Firmware dash number (0 to 99). r = Firmware revision (-, or A to Z).
Boot M&C Firmware Information	Command: Response:	<add/BFI_'cr' >add/BFI_'cr' VER_xxx.yyy.zzz'cr' FW/nnnnnn-ddr'cr' mm/dd/yy'cr'lf]	Where: xxx.yyy.zzz = Software version number (0.0.0 to 999.999.999). nnnnnn = Firmware number (0 to 999999). dd = Firmware dash number (0 to 99). r = Firmware revision (-, or A to Z).

B Appendix B. SDM-300/-300A SYSTEM INSTALLATION

This appendix describes the system installation for the following configurations:

- 25-pin, EIA-422/-530, EIA-232, V.35, G.703
- 34-pin, EIA-422/-449, V.35, G.703
- 37-pin, EIA-422/-449, LVDS-DVB, V.35, G.703
- 50-pin, ASYNC, IBS, IDR, D&I
- 100-pin, RS-301 Switch

B.1 System Installation

The system installation can vary for 25-pin to 100-pin configurations. This manual will not describe the possible installation of mixed data interfaces. However, any problem arising from the installation should be addressed to Comtech EFData Customer Support department.

B.1.1 System Installation (Standard Configuration)

Refer to Table B-1 for cable assemblies applicable to the standard configuration.

Table B-1. Standard Configuration Cabling

Item No.	Part No.	Description
1A	PL/3588	Data Cable, 25-pin
1B	PL/0725	Data Cable, 34-pin
1C	PL/0730	Data Cable, 37-pin
1D	PL/0737-4 (PL/5665-4) PL/0737-6 (PL/5665-8) PL/0737-8 (PL/566-12)	Data Cable, 50-pin, 4 feet Data Cable, 50-pin, 8 feet Data Cable, 50-pin 8 feet Notes: 1. Data Cable, 50-pin is available with right angle connector, PL/0737R-X. 2. Data Cable, 50-pion is available with ECL interface, PL/4807-X.
2	PL/0813-4 PL/0813-8	BNC Cable, 48.0 ± 1.5 inches (length) BNC Cable, 96.0 ± 3.0 inches (length)
3	PL/6239	Cable Assy, Remote Control with Termination
4	PL/6051-1	Power Cable Assemblies

Note: Alternate part is provided in parenthesis.

Refer to Figure B-1 for cabling the standard configuration.

1. Mount the SMS-301 1:1 switch in a standard equipment rack. Secure with four bolts.
2. Connect the data interface connector (Figure B-1) as follows:
 - a. Connect the “COMM” data interface connector (J1) to the customer-furnished equipment, using a customer-furnished cable assembly.
 - b. Connect the “A” data interface connector (J2) to the prime modulator Data I/O interface connector, using applicable data cable listed in Table B-1, items 1A through 1D.
 - c. Connect “B” data interface connector (J3) to the backup modulator data I/O interface connector using applicable data cable listed in Table B-1, items 1A through 1D.
3. Connect REMOTE connector at the prime modulator, bacvkup modulotr, to the COMM connector at the 1:1 switch, using PL/6239 cable assembly. Connect to customer-furnished equipment.

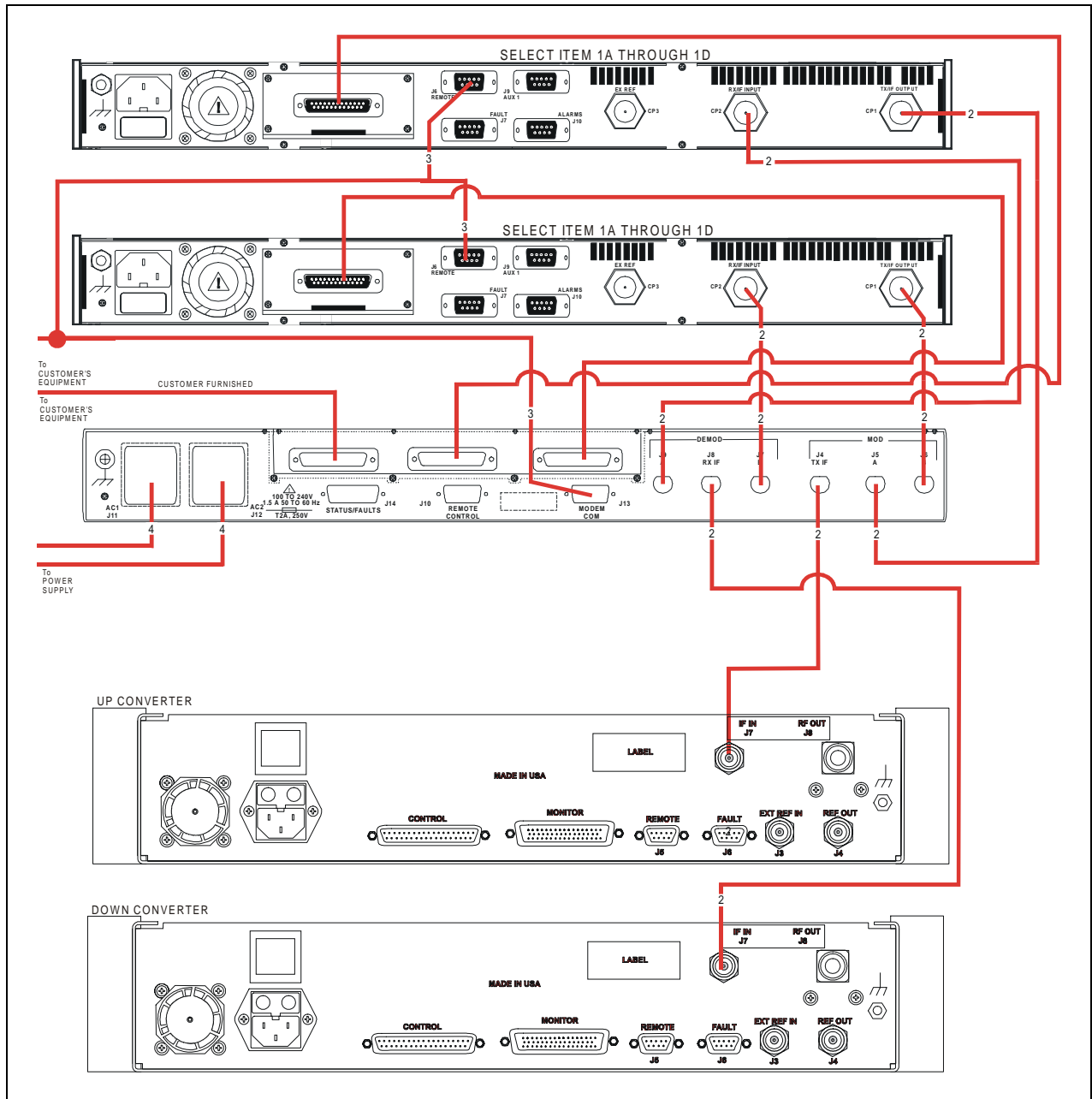

Figure B-1. System Installation (Standard Configuration)

4. Connect MOD side of 1:1 switch as follows:
 - a. Connect “TX IF” connector (J4) to IF IN connector (J7) on the rear panel of the up converter, using Cable PL/0813-X.
 - b. Connect the “A” connector (J5) to the prime modulator TX IF OUT connector (CP1), using Cable PL/0813-X.
 - c. Connect the “B” connector (J6) to the backup modulator TX IF OUT connector (CP1), using Cable PL/0813-X.
5. Connect DEMOD side of 1:1 switch as follows:
 - a. Connect the “B” connector (J7) to the backup modulator “RX IF IN” connector (CP2), using Cable PL/0813-X.
 - b. Connect “RX IF” connector (J8) to the down converter ‘IF OUT” connector (J7), using Cable PL/0813-X.
 - c. Connect the “A” connector (J9) to the prime modulator “RX IF IN” connector (CP2), using Cable PL/0813-X.
6. Connect AC power to AC1 (J11) and AC2 (J12) with power cables PL/6051-1.
 - a. If two AC power sources are available, connect AC1 and the prime modulator to one AC source and AC2 and the backup modulator to the other AC source.
 - b. If the DC power option is used, connect the DC voltage to the terminal blocks in a similar manner.

B.1.2 System Installation (RS-301 Switch Installed)

After unpacking the 1:1 switch and the RS-301 Remote Switch, refer to Table B-2 and the following instructions.

Table B-2. RS-301 Configuration Cabling

Item No.	Part No.	Description
1	PL/CA90101G100-4	Data Cable, 100-pin
2	PL/0813-4 PL/0813-8	BNC Cable, 48.0 ± 1.5 inches (length) BNC Cable, 96.0 ± 3.0 inches (length)
3	PL/6239	Cable Assy, Remote Control with Termination
4	PL/6051-1	Power Cable Assemblies

B.1.3 Connect System Installation with RS-301 Switch

Refer to Figure B-2 for cabling with the RS-301 Switch installed.

1. Mount the 1:1 switch in a standard equipment rack with four bolts.
2. Mount the remote switch (RS-301) in the same rack using four bolts.
3. Connect the Data I/O interface as follows:
 - a. Connect the “RREMOTE SWITCH CONTROL” connector (J1) to the “SWITCH CONTROL INTERFACE” connector (J16) on the RS-301 switch, using cabling PL/CA90101G100-4.
 - b. Connect the “MODEM A DATA” connector (J14) on the RS-301 switch to the prime modulator Data I/O connector, using Cable PL/CA90101G100-4
 - c. Connect the “MODEM B DATA” connector (J15) on the remote switch to the backup modulator Data connector, using Cabling PL/90101G100-4.
4. Connect the MOD side of the 1:1 switch as follows:
 - a. Connect the “TX IF” BNC connector (J4) in the 1:1 switch rear panel to the top converter IF IN (J7), using Cable PL/0813-X.
 - b. Connect the “A” BNC connector (J5) to the prime modem “TX IF OUT” (CP1), using Cable PL/0813-X.
 - c. Connect the “B” BNC connector (J6) to the backup modem “TX IF OUT” (CP1), using Cable PL/0813-X.

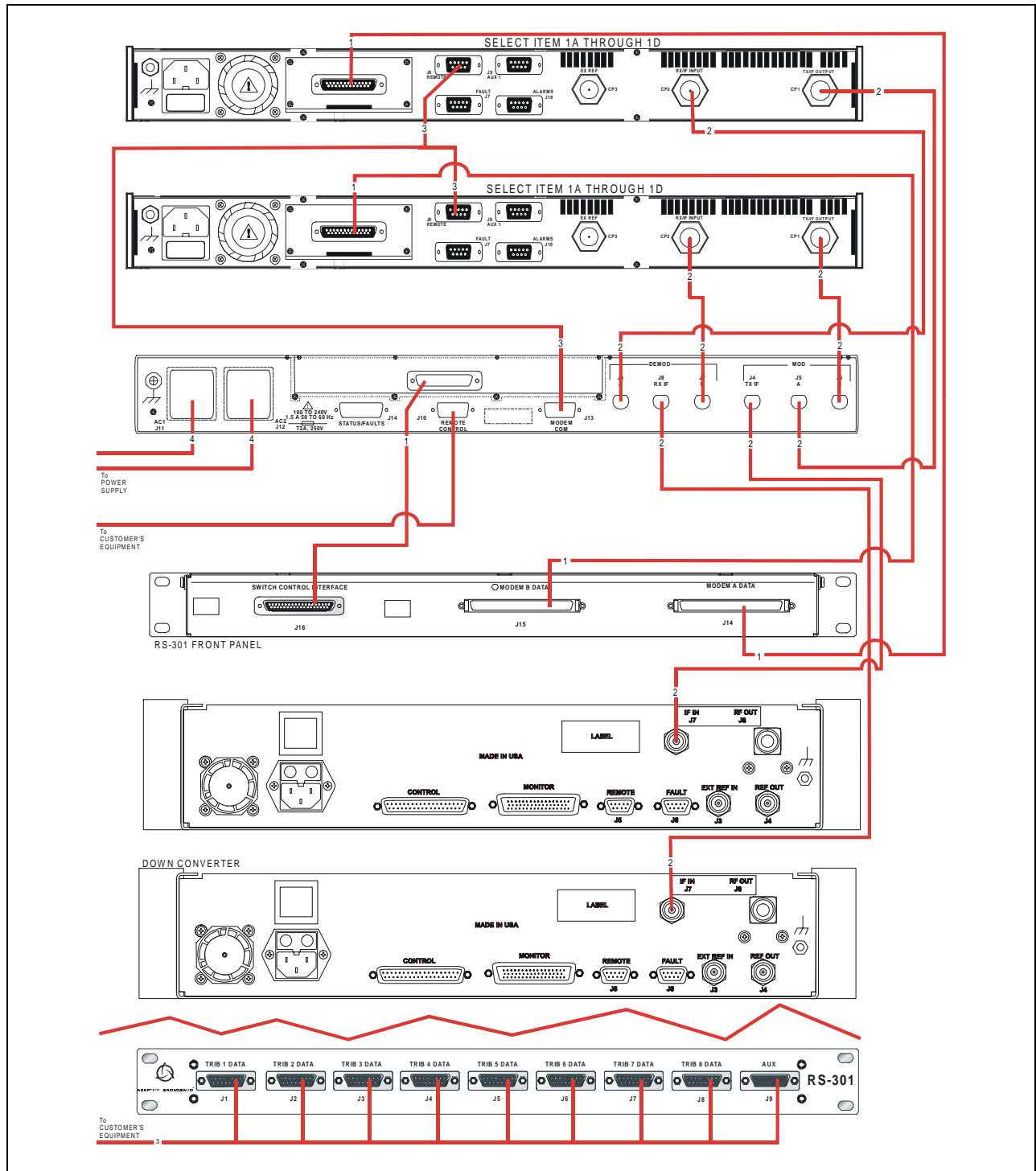

Figure B-2. System Installation (RS-301 Installed)

5. Connect the DEMOD side of the 1:1 switch as follows:
 - a. Connect the “RX IF” BNC connector (J8) to the down converter “IF OUT” (J7), using Cable PL/0813-X.
 - b. Connect the “A” BNC connector (J9) to the prime modem “RX IF IN” , using Cable PL/0813-X.
 - c. Connect the “B” BNC (J7) to the backup modem “RX IF IN”, using Cable PL/ 0813-X.
6. Connect the customer-equipment (as required) to the remote switch “TRIBUTARY” cuconnectors, using Cable PL/6239.
7. Connect AC power to AC1 (J11) and AC2 (J12) with power cable assemblies PL/6051-1.
 - a. If two AC power sources are availble, connect AC1 and the prime modem to one AC source, and AC2 and the backup modem to the other AC source.
 - b. If the DC power option is used, connect the DC voltage to the terminal blocks in a similar manner.
8. Connect the remote terminal to the “REMOTE CONTROL” (J10) connector, REMOTE (J6) on the priome modulator and REMOTE (J6) on the backup modulator using Cable PL/6239.

This page is intentionally left blank.

Appendix C. SDM-2020 System Installations

This appendix describes the installation options available for the SMS-301 1:1 Switch and the SDM-2020 Satellite Modulator.

C.1 Installation Options

C.1.1 Connect Low Voltage Differential Signal Interface (Optional)

Note: The section defines the requirements of the Low Voltage Differential Signal (LVDS) data interface for video and high-speed data applications used with the SDM-2020 Satellite Modulator.

C.1.1.1 Description

The 1:1 switch LDVS interface is a plug-in module that interfaces with the SDM-2020 Satellite Modulator. The interface uses serial and parallel clock and data formats, where as the SDM-2020 LVDS and Digital Video Broadcast (DVB) interfaces are either serial or parallel format. The difference between the LVDS and DVB (EIA-422) interfaces are the drivers and receivers.

- Parallel format: The interface is a DVB 8 bit parallel synchronous (LVDS) or EIA-422 (DVB).
- Serial format: MSB (Data 7) is used for serial data and clock.

The interface operates to the specifications described in Table C-1.

Table C-1. LVDS/DVB Specifications

General Specification	
Interface Type	LVDS/DVB Synchronous Serial/Parallel EIA-422 DVB
Data Rate Serial Parallel	1.5 to 32 Mbit/s 0.1875 to 12.5 Mbit/s
Connectors	37-pin D female for TX and RX data
Electrical Properties	Per TIA/EIA-644
Signal Types	TX, TX Clock, TX Data, Data Valid, and SYNC per TM1449

C.1.1.2 Connect to SDM-2020 Modulator with LVDS Interface

Refer to Figure C-1.

1. Connect the “COMM” data interface connector (J1) to the DTE equipment.

Note: Equivalent cable shall be computer grade, 100Ω, incorporating twisted and shielded pairs. Typical length shall be ≤ 16 feet (5 meters).

2. Connect the “A” data interface connector (J2) to the prime SDM-2020 Modulator “TX IN” (J4) connector and “AUX” (J5) connector using Cable (CA/6217) or equivalent.
3. Connect the “B” data interface connector (J3) to the backup SDM-2020 Modulator “TX IN” (J4) connector “AUX” (J5) connector using Cable (CA/6217) or equivalent.

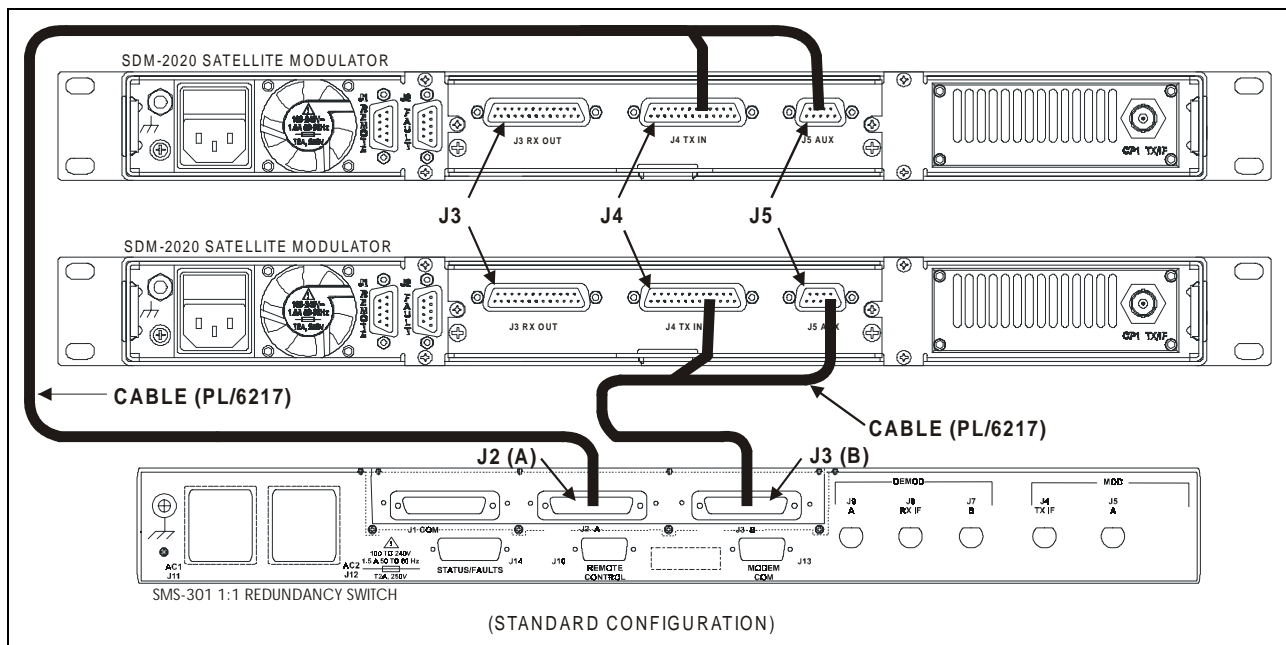

Figure C-1. Connect to SDM-2020 Modulator with LVDS Interface

C.1.2 Connect to SDM-2020 Satellite Modulator with EIA-422 Interface

Note: The section defines the requirements of the EIA-422 data interface for video and high-speed data applications used with the SDM-2020 Satellite Modulator. This interface uses serial format only.

C.1.2.1 Description

The SMS-301 data interface is a plug-in module that interfaces with the SDM-2020 Satellite Modulator. The interface used EIA-530 serial format. Specifications are as referenced herein:

- EIA-422, Electrical Characteristics of Balanced Voltage Digital Interface Circuits
- EIA-530, High-Speed 25-Position Interface for data Circuit – Terminating Equipment

The interface operates to the specifications described in Table C-1.

Table C-2. EIA-422/EIA-530 Specifications

General Specification	
Interface Type	EIA-422/EIA-530 Synchronous (Serial)
Data Rate	1.5 to 18 Mbit/s (Serial)
Connectors	37-pin D female for serial data
Electrical Properties	Per EIA-422
Signal Types	SD, ST, TT, RS, CS, RD, RT, RR, (CD)

C.1.2.2 Connect to SDM-2020 Modulator with EIA-422 Interface

Refer to Figure C-2.

1. Connect the “COMM” data interface connector (J1) to the DTE equipment.

Note: Equivalent cable shall be computer grade, 100Ω, incorporating twisted and shielded pairs. Typical length shall be ≤ 16 feet (5 meters).

2. Connect the “A” data interface connector (J2) to the prime SDM-2020 Modulator “SERIAL” (J4) connector using Cable (CA/6679) or equivalent.
 3. Connect the “B” data interface connector (J3) to the backup SDM-2020 Modulator “SERIAL” (J4) connector using Cable (CA/6679) or equivalent
- Connection to SDM-2020 Satellite Modulator with EIA-422 (DVB) TX Interface (18 Mbit/s Serial Data)

Note: The section defines the requirements of the EIA-422 (DVB) TX data interface for video and high-speed data applications used with the SDM-2020 Satellite Modulator.

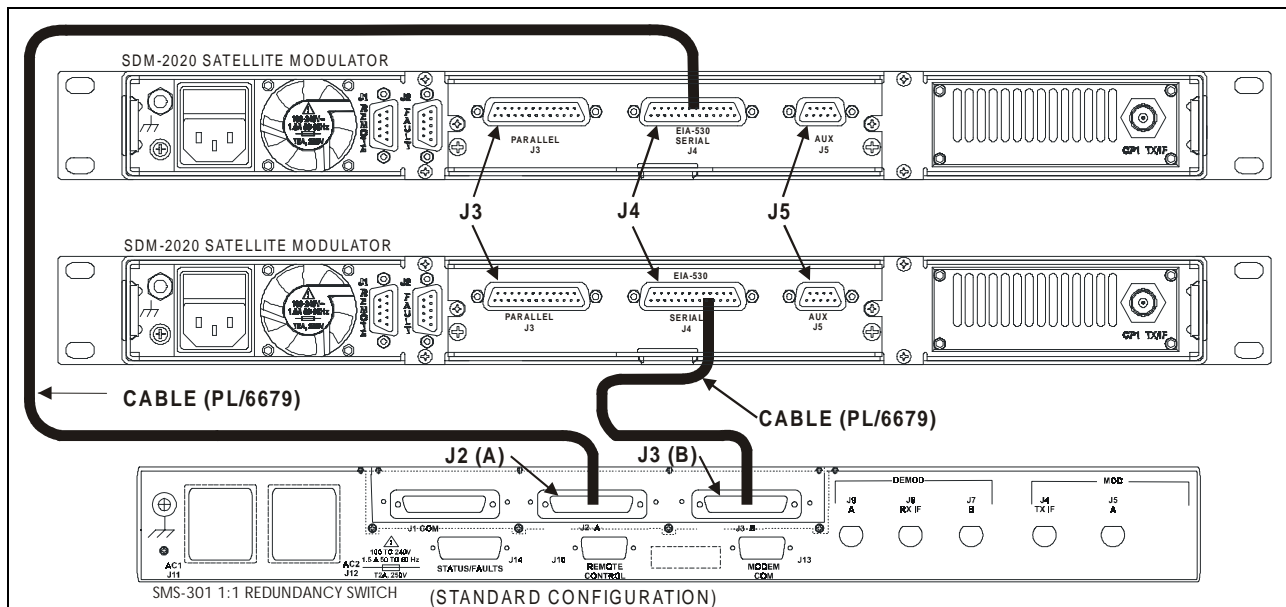

Figure C-2. Connect to SDM-2020 Modulator with EIA-422 Interface

C.1.3 Connect to SDM-2020 Satellite Modulator with EIA-422 DVB TX Interface

C.1.3.1 Description

The SMS-301 data interface is a plug-in module that interfaces with the SDM-2020 Satellite Modulator. The maximum data rate is 18 Mbit/s for serial data.

The SDM-2020 Modulator configured with the EIA-422 data interface is identified as follows:

- Parallel Connector (J3) is used for DVB EIA-422 either parallel or serial data.
- Serial connector (J3) is for (EIA-530) serial differential data operation.

Note: SDM-2020 Modulator with ASI/EIA-422 data interface can be configured using the same instructions as the EIA-422 configuration.

The interface operates to the specifications described in Table C-1.

Table C-3. EIA-422/EIA-530 Specifications

General Specification	
Interface Type	EIA-422/EIA-530 Synchronous (Serial)
Data Rate	1.5 to 18 Mbit/s (Serial)
Connectors	37-pin D female for serial data
Electrical Properties	Per EIA-422
Signal Types	SD, ST, TT, RS, CS, RD, RT, RR, (CD)

The cable pin assignments are specified in Table C-4.

Table C-4. Cable Pin Assignments (CA/6217)

SMS-301 (DB-37)			SDM-2020M DVB
Pin #	Name	Signal Function	Parallel or Serial (J3 DB 25 EIA-422)
19	CLK-A	Master Clock	1
37	CLK-B	(TT Serial)	14
34	SYNC-A	Synchronized	12
15	SYNC-B		25
33	VAL-A	Data Valid	11
14	VAL-B		24
32	DAT7-A	Data Bit 7 (Serial Data Bit)	3
13	DAT7-B		16
31	DAT6-A	Data Bit 6	4
12	DAT6-B		17
30	DAT5-A	Data Bit 5	5
11	DAT5-B		18
29	DAT4-A	Data Bit 4	6
10	DAT4-B		19
28	DAT3-A	Data Bit 3	7
9	DAT3-B		20
27	DAT2-A	Data Bit 2	8
8	DAT2-B		21
26	DAT1-A	Data Bit 1	9
7	DAT1-B		22
25	DAT0-A	Data Bit 0	10
6	DAT0-B		23
1	SG	Signal Ground	13
21	REFCLK-A	Reference Clock (ST Serial)	15 Reference Clock or 2 Ground
2	REFCLK-B		
22	DF	DEMOM Fault	AUX (J5) Pin 2 DB 9
3	MF	MOD Fault	AUX (J5) Pin 6 DB 9

C.1.3.2 Connect to SDM-2020 Modulator with EIA-422 DVB TX Interface

Refer to Figure C-3.

1. Connect the “COMM” data interface connector (J1) to the DTE equipment.

Note: Equivalent cable shall be computer grade, 100Ω, incorporating twisted and shielded pairs. Typical length shall be ≤ 16 feet (5 meters).

2. Connect the “A” data interface connector (J2) to the prime SDM-2020 Modulator “SERIAL” (J4) connector and “AUX” (J5) connector using Cable (CA/6217) or equivalent.
3. Connect the “B” data interface connector (J3) to the backup SDM-2020 Modulator “SERIAL” (J4) connector and “AUX” (J5) connector using Cable (CA/6217) or equivalent

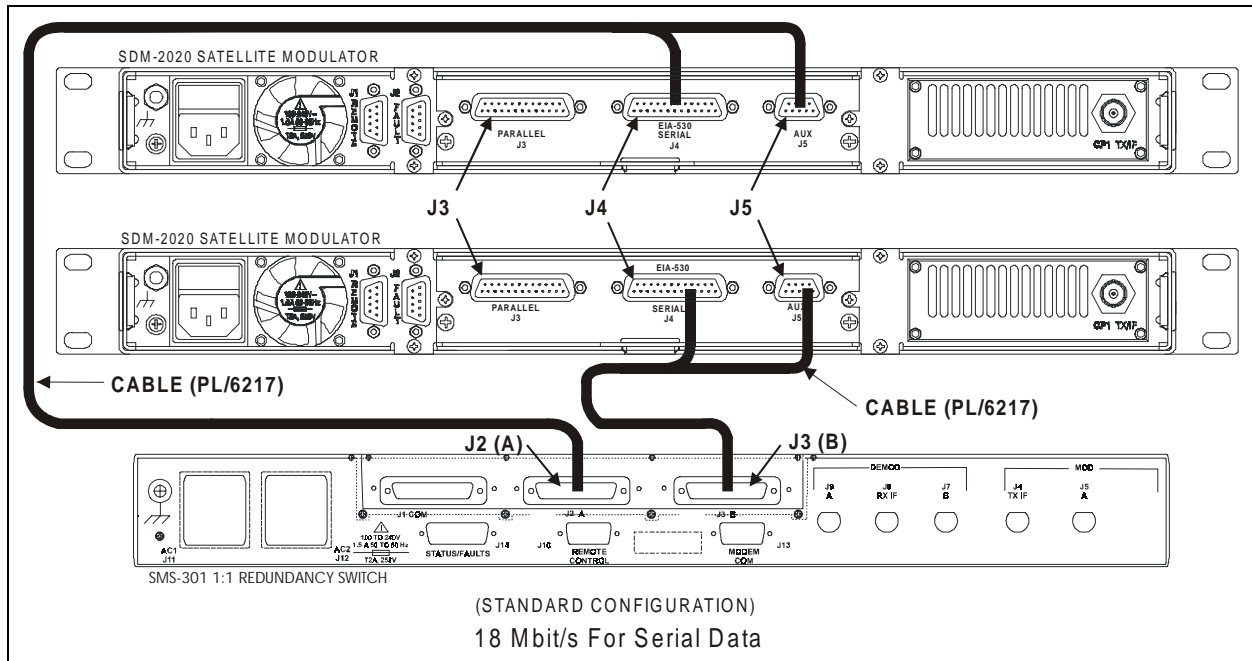

Figure C-3. Connect to SDM-2020 Modulator with EIA-422 (DVB) TX Interface (18 Mbit/s Serial Data)

C.1.4 Connect to SDM-2020 Satellite Modulator with EIA-422 (DVB) TX Interface (100 Mbit/s Parallel Data)

Note: The section defines the requirements of the EIA-422 (DVB) TX data interface for video and high-speed data applications used with the SDM-2020 Satellite Modulator.

C.1.4.1 Description

The SMS-301 data interface is a plug-in module that interfaces with the SDM-2020 Satellite Modulator. The maximum data rate is 100 Mbit/s for parallel data.

The SDM-2020 Modulator configured with the EIA-422 data interface is identified as follows:

- Parallel Connector (J3) is used for DVB EIA-422 either parallel or serial data.
- Serial connector (J3) is for (EIA-530) serial differential data operation.

Note: SDM-2020 Modulator with ASI/EIA-422 data interface can be configured using the same instructions as the EIA-422 configuration.

The cable pin assignments are specified in Table C-5.

Table C-5. Cable Pin Assignments (CA/6217)

SMS-301 (DB-37)			SDM-2020M DVB
Pin #	Name	Signal Function	Parallel or Serial (J3 DB 25 EIA-422)
19	CLK-A	Master Clock	1
37	CLK-B	(TT Serial)	14
34	SYNC-A	Synchronized	12
15	SYNC-B		25
33	VAL-A	Data Valid	11
14	VAL-B		24
32	DAT7-A	Data Bit 7 (Serial Data Bit)	3
13	DAT7-B		16
31	DAT6-A	Data Bit 6	4
12	DAT6-B		17
30	DAT5-A	Data Bit 5	5
11	DAT5-B		18
29	DAT4-A	Data Bit 4	6
10	DAT4-B		19
28	DAT3-A	Data Bit 3	7
9	DAT3-B		20
27	DAT2-A	Data Bit 2	8
8	DAT2-B		21
26	DAT1-A	Data Bit 1	9
7	DAT1-B		22
25	DAT0-A	Data Bit 0	10
6	DAT0-B		23
1	SG	Signal Ground	13
21	REFCLK-A	Reference Clock (ST Serial)	15 Reference Clock or 2 Ground
2	REFCLK-B		
22	DF	DEMOM Fault	AUX (J5) Pin 2 DB 9
3	MF	MOD Fault	AUX (J5) Pin 6 DB 9

C.1.4.2 Connect to SDM-2020 Modulator with EIA-422 DVB TX Interface

Refer to Figure C-4.

1. Connect the “COMM” data interface connector (J1) to the DTE equipment.

Note: Equivalent cable shall be computer grade, 100Ω, incorporating twisted and shielded pairs. Typical length shall be ≤ 16 feet (5 meters).

2. Connect the “A” data interface connector (J2) to the prime SDM-2020 Modulator “PARALLEL” (J4) connector and “AUX” (J5) connector using Cable (CA/6217) or equivalent.
3. Connect the “B” data interface connector (J3) to the backup SDM-2020 Modulator “PARALLEL” (J4) connector and “AUX” (J5) connector using Cable (CA/6217) or equivalent

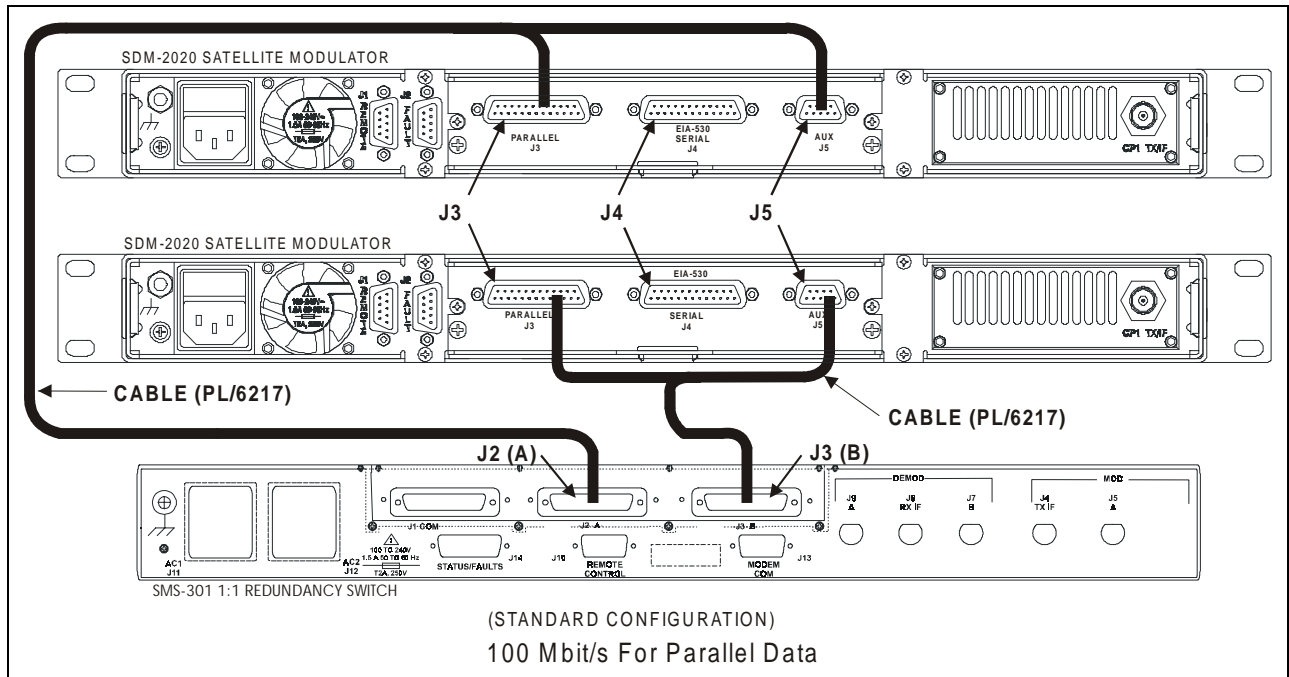

Figure C-4. Connect to SDM-2020 Modulator with EIA-422 (DVB) TX Interface (100 Mbit/s Parallel Data)

C.1.5 Connect to SDM-2020 Satellite Modulator I/O Connector, 25-Pin Interface

Note: The section defines the requirements of the I/O 25-pin data interface for video and high-speed data applications used with the SDM-2020 Satellite Modulator. This interface uses serial format only.

C.1.5.1 Description

The SMS-301 data interface is a plug-in module that interfaces with the SDM-2020 Satellite Modulator. The interface used EIA-530 serial format

Refer to Table C-6 for the cable pin assignments.

Table C-6. Pin Assignments, 25-Pin

SMS-301 DB25 Connector		SDM-2020 EIA-530	
Pin #	Name	Serial (J4) DB 25	
24	TT-A	24	TT-A
11	TT-B	11	TT-B
2	SD-A	2	SD-A
14	SD-B	14	SD-B
1	SG	1	SG
15	ST-A	15	ST-A
12	ST-B	12	ST-B
21	DF	21	DF
25	MF	25	MF

C.1.5.2 Connect to SDM-2020 Modulator with I/O Connector, 25-Pin Interface

Refer to Figure C-5.

1. Connect the “COMM” data interface connector (J1) to the DTE equipment.

Note: Equivalent cable shall be computer grade, 100Ω, incorporating twisted and shielded pairs. Typical length shall be ≤ 16 feet (5 meters).

2. Connect the “A” data interface connector (J2) to the prime SDM-2020 Modulator “SERIAL” (J4) connector using Cable (CA/3588) or equivalent.
3. Connect the “B” data interface connector (J3) to the backup SDM-2020 Modulator “SERIAL” (J4) connector using Cable (CA/3588) or equivalent

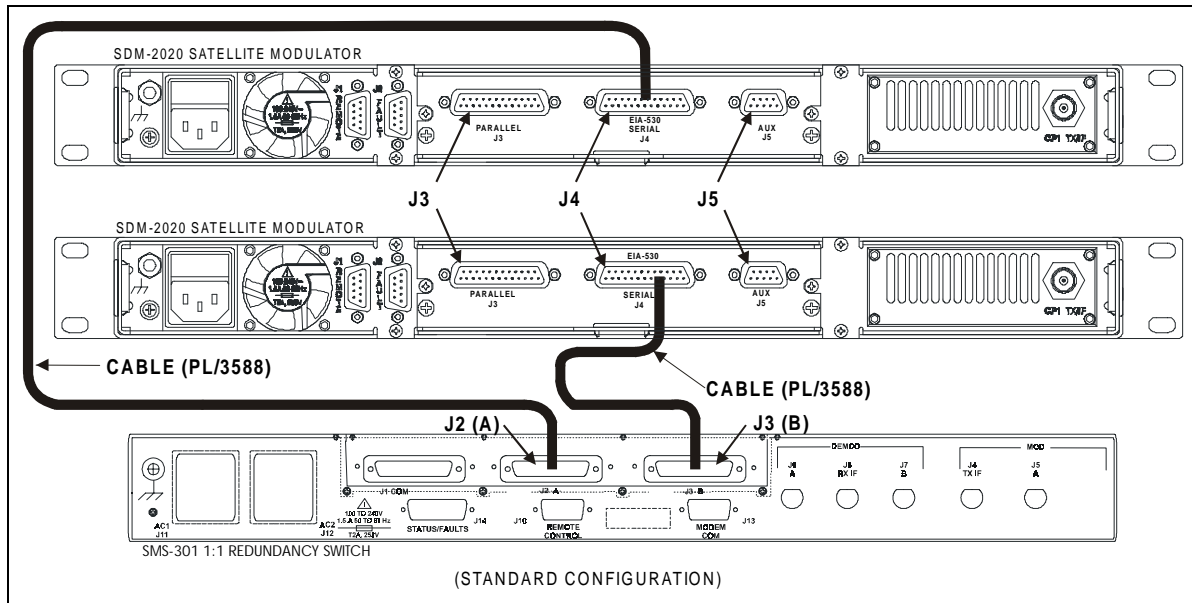

Figure C-5. Connect to SDM-2020 Modulator with I/O Connector, 25-Pin Interface

This page is intentionally left blank.

Glossary

The following is a list of acronyms and abbreviations that may be found in this manual:

Acronym/ Abbreviation	Definition
Ω	Ohms
@	at
A	Ampere
AC	Alternating Current
Al	Alarm
ASCII	American Standard Code for Information Interchange
ASYNC	Asynchronous
AUX	Auxiliary
bit/s	bits per second
BW	Backward Alarm or Bandwidth
C	Celsius
CLK	Clock
CLR	Clear
cm	Centimeters
COM	Common
COMM	Communication
cr	Carriage Return
CS or CTS	Clear to Send
D&I	Drop and Insert
dB	Decibels
D/C	Down Converter
DC	Direct Current
DD	Day
DF	DEMOD Fault
DAT	Data Bit
Demod	Demodulator
DEMUX	Demultiplexer
DM	Data Mode
DMDONL	Demodulator On-Line
DTE	Data Terminal Equipment

DVB	Digital Video Broadcast
EFD	EFData Compatible
EIA	Electronic Industries Association
EXC	External Clock
EXT	External Reference Clock
F	Fahrenheit
FW	Firmware
GND	Ground
Hz	Hertz (cycle per second)
I/O	Input/Output
IBS	INTELSAT Business Services
IDR	Intermediate Data Rate
IESS	INTELSAT Earth Station Standards
IF	Intermediate Frequency
kbit/s	Kilobits per second (10 ³ bits per second)
LCD	Liquid Crystal Display
LED	Light-Emitting Diode
If	Line Feed
LVDS	Low Voltage Differential Signal
m	mille (10 ⁻³)
M&C	Monitor and Control
mA	Milliamperes
Max	Maximum
Mbit/s	Megabits per second
MC	Monitor and Control or Master Clock
MF	Modulator Fault
Mod	Modulator
MODONL	Modulator On-Line
MUX	Multiplexer
NC	No Connection or Normally Closed
PL	Parts List
PWR	Power
RAM	Random Access Memory
RD	Receive Data
REF	Reference
RF	Radio Frequency
RMA	Return Material Authorization
RR	Receiver Ready
RS	Ready to Send, Recommended Standard, or Reed-Solomon
RT	Receive Timing
RTS	Request to Send
RX	Receive (Receiver)
RXCLK	Receive Clock
RXD	Receive Data
RZ	Return-to-Zero
s	Second
SCR	Serial Clock Receive
SCT	Serial Clock Transmit
SCTE	Serial Clock Transmit External
SD or SDA	Send Data
SG	Signal Ground
SLC	Serial Clock
SMS	Satellite Multiservice System
ST	Send Timing
Sub	Subminiature

SW	Switch
SYNC	Synchronize
TP	Test Point
TT	Terminal Timing
TX	Transmit (Transmitter)
TXCLK	Transmit Clock
TXD	Transmit Data
TXO	TX Octet
U/C	Up converter
US(A)	United States (of America)
V	Volts
VAC	Volts, Alternating Current
VDC	Volts, Direct Current
Ver	Version
W	Watt
YY	Year

This page is intentionally left blank.

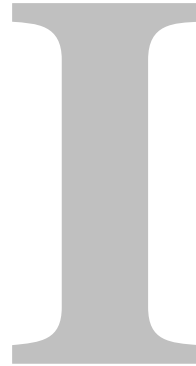

Index

- AC Power (J11 and J12), 2–15
- Board List, 2–15, 3-4
- Command/Response, 1–4
- Configuration Commands/Responses, 1–2, 1–7, 3-1, 3-2, 3-3, 3-5, 3-7, 3-10, 3-11, 3-12, 3-13, 3-15, 3-16, 3-28, A-2, A-3
- Configuration Recall Menu, A-5, A-6
- Configuration Save Menu, 3-16
- Configuration Switch Control Menu, 3-15
- Configuration System Menu, 3-10, 3-11
- Connect SMS-301 Switch to SDM-2020 Modulator with I/O Connector, 25-Pin Interface, 2–21
- Connect SMS-301 Switch to SDM-2020 Modulator with RS-422 DVB TX Interface, 2–19, 3-12, 3-13
- Connect to SDM-2020 Modulator with LVDS Interface, 2–28
- Connect to SDM-2020 Satellite Modulator I/O Connector, 25-Pin Interface, 2–23, 2–26
- Connect to SDM-2020 Satellite Modulator with RS-422 (DVB) TX Interface (18 Mbit/s Serial Data), 2–20
- Connection to SDM-2020 Satellite Modulator I/O Connector, 25-Pin Interface, 2–23, 2–26
- Connection to SDM-2020 Satellite Modulator with Low Voltage Differential Signal Interface (Optional), 2–20
- Connection to SDM-2020 Satellite Modulator with EIA-422 (DVB) TX Interface (100 Mbit/s Parallel Data), 2–21
- Data I/O (J1, J2, J3), 37-Pin (PL/5952), 4-4
- Data I/O Connector (J1, J2, J3) 37-Pin (PL/6201-2), 2–9
- Data I/O Connector (J1, J2, J3), 25-Pin (PL/6026), 2–10, 4-3
- Data I/O Connector (J1, J2, J3), 37-Pin (PL/5952), 2–8
- Data I/O Connector (J1, J2, J3), 50-Pin (PL/5951), 2–7
- DC Power (J11 and J12) (Optional), 2–6
- Description (Standard Configuration), 2–15
- Description (With RS-301 Option), 1–2
- Device Address, 1–3
- EIA-422/-449, G.703, or V.35 (J1, J2, J3), 37-Pin (PL/5952), A-2, A-3
- EIA-422/DVB TX (J1, J2, J3), 25-Pin (PL/6026), 4-3
- EIA-422/EIA-449/V.35, A-2, A-3
- End Character, 4-4
- Equipment Inspection, A-4
- External Connections, A-4
- Fault Isolation, 2–3
- Fault Summary Status Commands/Responses, 5-1, 5-4
- Faults/Alarms, A-9
- Faults3-5, 3-5, 3-7, 3-18, 3-19, 3-20, 3-21
- Front Panel, 3-5, 3-7, 3-18, 3-19, 3-20, 3-21
- Front Panel Keypad, 1–5, 1–6, 3-1, 3-6, 3-9
- Front Panel Menus, 3-6
- Ground, 3-9
- IBS, IDR, ASYNC, or D&I (J1, J2, J3), 50-Pin (PL/5951), 2–4, 2–5, 2–6, 2–7, 2–8, 2–17, 2–23, 2–26, 4-5, 4-6, 4-7, 4-8, 4-11
- IF Connections
 - Transmit and Receive, 2–4, 2–5, 2–6, 2–8, 2–17, 4-3, 4-5, 4-6, 4-7, 4-8, 4-11
- Installation Options, 2–17
- Menu System, 4-3
- Message Structure, 3-7
- Modem Communications Configuration
 - Commands/Responses, A-2
- Monitor Menu, 1–2, 4-1
- Operation Mode, 3-17
- Prime Power, 3-2, 3-5, A-8, A-11
- Remote Switch (RS-301) Option, 2–14
- Remote Switch Control (J1) (RS-301 Option), 4-5
- RX IF Connectors (J7, J8, J9), 2–5
- Setup and Configuration, 2–13
- SMS-301 Data Interface, 3-2
- Specifications, 5-1
- Start Character, 5-1
- Status Commands/Responses, A-2

Status/Fault (J14), A-8
Stored Faults, 2-17
Stored Faults/Alarms, 2-17
Switch/Modem Communications Interface Connector
(J13), 3-7, 3-20, 3-21
System Commands/Responses, 2-16
System Installation (Standard Configuration), A-7
Theory of Operation, 5-1, 5-3
Transmit IF Connectors (J4, J5, J6), 4-2
Unpacking, 2-13
Utility Modem Control, 2-1
Utility System, 3-3, 3-4, 3-5, 3-22, 3-23, 3-26, 3-27, 4-3,
4-4, 4-5

METRIC CONVERSIONS

Units of Length

Unit	Centimeter	Inch	Foot	Yard	Mile	Meter	Kilometer	Millimeter
1 centimeter	—	0.3937	0.03281	0.01094	6.214×10^{-6}	0.01	—	—
1 inch	2.540	—	0.08333	0.2778	1.578×10^{-5}	0.254	—	25.4
1 foot	30.480	12.0	—	0.3333	1.893×10^{-4}	0.3048	—	—
1 yard	91.44	36.0	3.0	—	5.679×10^{-4}	0.9144	—	—
1 meter	100.0	39.37	3.281	1.094	6.214×10^{-4}	—	—	—
1 mile	1.609×10^5	6.336×10^4	5.280×10^3	1.760×10^3	—	1.609×10^3	1.609	—
1 mm	—	0.03937	—	—	—	—	—	—
1 kilometer	—	—	—	—	0.621	—	—	—

Temperature Conversions

Unit	° Fahrenheit	° Centigrade
32° Fahrenheit	—	0 (water freezes)
212° Fahrenheit	—	100 (water boils)
-459.6° Fahrenheit	—	273.1 (absolute 0)

Formulas
$C = (F - 32) * 0.555$
$F = (C * 1.8) + 32$

Units of Weight

Unit	Gram	Ounce Avoirdupois	Ounce Troy	Pound Avoir.	Pound Troy	Kilogram
1 gram	—	0.03527	0.03215	0.002205	0.002679	0.001
1 oz. avoir.	28.35	—	0.9115	0.0625	0.07595	0.02835
1 oz. troy	31.10	1.097	—	0.06857	0.08333	0.03110
1 lb. avoir.	453.6	16.0	14.58	—	1.215	0.4536
1 lb. Troy	373.2	13.17	12.0	0.8229	—	0.3732
1 kilogram	1.0×10^3	35.27	32.15	2.205	2.679	—



2114 WEST 7TH STREET TEMPE ARIZONA 85281 USA
480 • 333 • 2200 PHONE
480 • 333 • 2161 FAX